

SKiiP 37NAB12T4V1

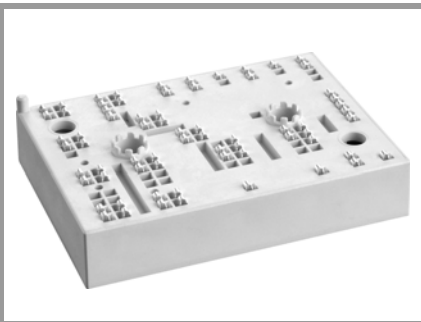

MiniSKiiP® 3

SKiiP 37NAB12T4V1

Features

- Trench 4 IGBTs
- Robust and soft freewheeling diodes in CAL technology
- Highly reliable spring contacts for electrical connections
- UL recognised file no. E63532

Typical Applications*

- Inverter up to 36 kVA
- Typical motor power 22 kW

Remarks

- V_{CEsat} , V_F = chip level value
- Case temp. limited to $T_C = 125^\circ\text{C}$ max. (for baseplateless modules $T_C = T_S$)
- product rel. results valid for $T_j \leq 150$ (recomm. $T_{op} = -40 \dots +150^\circ\text{C}$)

Absolute Maximum Ratings				
Symbol	Conditions		Values	Unit
Inverter - IGBT				
V_{CES}	$T_j = 25^\circ\text{C}$		1200	V
I_C	$T_j = 150^\circ\text{C}$	$T_s = 25^\circ\text{C}$	81	A
		$T_s = 70^\circ\text{C}$	62	A
I_C	$T_j = 175^\circ\text{C}$	$T_s = 25^\circ\text{C}$	90	A
		$T_s = 70^\circ\text{C}$	73	A
I_{Cnom}			75	A
I_{CRM}	$I_{CRM} = 3 \times I_{Cnom}$		225	A
V_{GES}			-20 ... 20	V
t_{psc}	$V_{CC} = 800\text{ V}$ $V_{GE} \leq 15\text{ V}$ $V_{CES} \leq 1200\text{ V}$	$T_j = 150^\circ\text{C}$	10	μs
T_j			-40 ... 175	$^\circ\text{C}$
Chopper - IGBT				
V_{CES}	$T_j = 25^\circ\text{C}$		1200	V
I_C	$T_j = 150^\circ\text{C}$	$T_s = 25^\circ\text{C}$	81	A
		$T_s = 70^\circ\text{C}$	62	A
I_C	$T_j = 175^\circ\text{C}$	$T_s = 25^\circ\text{C}$	90	A
		$T_s = 70^\circ\text{C}$	73	A
I_{Cnom}			75	A
I_{CRM}	$I_{CRM} = 3 \times I_{Cnom}$		225	A
V_{GES}			-20 ... 20	V
t_{psc}	$V_{CC} = 800\text{ V}$ $V_{GE} \leq 15\text{ V}$ $V_{CES} \leq 1200\text{ V}$	$T_j = 150^\circ\text{C}$	10	μs
T_j			-40 ... 175	$^\circ\text{C}$
Inverse - Diode				
V_{RRM}	$T_j = 25^\circ\text{C}$		1200	V
I_F	$T_j = 150^\circ\text{C}$	$T_s = 25^\circ\text{C}$	74	A
		$T_s = 70^\circ\text{C}$	55	A
I_F	$T_j = 175^\circ\text{C}$	$T_s = 25^\circ\text{C}$	83	A
		$T_s = 70^\circ\text{C}$	66	A
I_{Fnom}			75	A
I_{FRM}	$I_{FRM} = 3 \times I_{Fnom}$		225	A
I_{FSM}	$t_p = 10\text{ ms, sin } 180^\circ, T_j = 150^\circ\text{C}$		430	A
T_j			-40 ... 175	$^\circ\text{C}$
Freewheeling - Diode				
V_{RRM}	$T_j = 25^\circ\text{C}$		1200	V
I_F	$T_j = 150^\circ\text{C}$	$T_s = 25^\circ\text{C}$	74	A
		$T_s = 70^\circ\text{C}$	55	A
I_F	$T_j = 175^\circ\text{C}$	$T_s = 25^\circ\text{C}$	83	A
		$T_s = 70^\circ\text{C}$	66	A
I_{Fnom}			75	A
I_{FRM}	$I_{FRM} = 3 \times I_{Fnom}$		225	A
I_{FSM}	$t_p = 10\text{ ms, sin } 180^\circ, T_j = 150^\circ\text{C}$		430	A
T_j			-40 ... 175	$^\circ\text{C}$

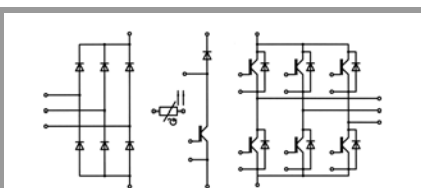

NAB

SKiIP 37NAB12T4V1

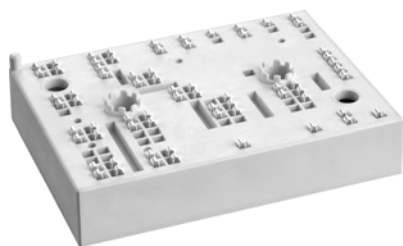

MiniSKiIP® 3

SKiIP 37NAB12T4V1

Features

- Trench 4 IGBTs
- Robust and soft freewheeling diodes in CAL technology
- Highly reliable spring contacts for electrical connections
- UL recognised file no. E63532

Typical Applications*

- Inverter up to 36 kVA
- Typical motor power 22 kW

Remarks

- V_{CEsat} , V_F = chip level value
- Case temp. limited to $T_C = 125^\circ\text{C}$ max. (for baseplateless modules $T_C = T_S$)
- product rel. results valid for $T_j \leq 150$ (recomm. $T_{op} = -40 \dots +150^\circ\text{C}$)

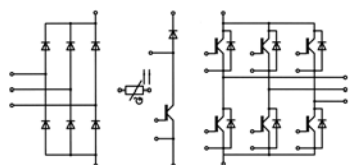

NAB

Absolute Maximum Ratings				
Symbol	Conditions	Values	Unit	
Rectifier - Diode				
V_{RRM}	$T_j = 25^\circ\text{C}$	1600	V	
I_F	$T_s = 25^\circ\text{C}, T_j = 150^\circ\text{C}$	81	A	
I_{Fnom}		25	A	
I_{FSM}	10 ms	$T_j = 25^\circ\text{C}$	700	A
	sin 180°	$T_j = 150^\circ\text{C}$	490	A
I^2t	10 ms	$T_j = 25^\circ\text{C}$	2400	A ² s
	sin 180°	$T_j = 150^\circ\text{C}$	1200	A ² s
T_j		-40 ... 150	°C	
Module				
$I_t(\text{RMS})$	$T_{\text{terminal}} = 80^\circ\text{C}, 20\text{A per spring}$	80	A	
T_{stg}		-40 ... 125	°C	
V_{isol}	AC sinus 50Hz, 1 min	2500	V	

Characteristics					
Symbol	Conditions	min.	typ.	max.	Unit
Inverter - IGBT					
$V_{CE(sat)}$	$I_C = 75\text{ A}$ $V_{GE} = 15\text{ V}$ chiplevel	$T_j = 25^\circ\text{C}$	1.85	2.10	V
		$T_j = 150^\circ\text{C}$	2.25	2.45	V
V_{CE0}		$T_j = 25^\circ\text{C}$	0.8	0.9	V
		$T_j = 150^\circ\text{C}$	0.7	0.8	V
r_{CE}	$V_{GE} = 15\text{ V}$	$T_j = 25^\circ\text{C}$	14	16	mΩ
		$T_j = 150^\circ\text{C}$	21	22	mΩ
$V_{GE(th)}$	$V_{GE} = V_{CE}\text{ V}, I_C = 3\text{ mA}$	5	5.8	6.5	V
I_{CES}	$V_{GE} = 0\text{ V}$ $V_{CE} = 1200\text{ V}$	$T_j = 25^\circ\text{C}$	0.1	0.3	mA
					mA
C_{ies}	$V_{CE} = 25\text{ V}$ $V_{GE} = 0\text{ V}$	$f = 1\text{ MHz}$	4.40		nF
C_{oes}		$f = 1\text{ MHz}$	0.29		nF
C_{res}		$f = 1\text{ MHz}$	0.23		nF
Q_G	- 8 V...+ 15 V		425		nC
R_{Gint}	$T_j = 25^\circ\text{C}$		10.00		Ω
$t_{d(on)}$	$V_{CC} = 600\text{ V}$	$T_j = 150^\circ\text{C}$	150		ns
t_r	$I_C = 75\text{ A}$	$T_j = 150^\circ\text{C}$	35		ns
E_{on}	$R_{Gon} = 2\ \Omega$	$T_j = 150^\circ\text{C}$	9.7		mJ
$t_{d(off)}$	$R_{Goff} = 2\ \Omega$	$T_j = 150^\circ\text{C}$	355		ns
t_f		$T_j = 150^\circ\text{C}$	60		ns
E_{off}	$V_{GE} = +15/-15\text{ V}$	$T_j = 150^\circ\text{C}$	6.8		mJ
$R_{th(j-s)}$	per IGBT		0.58		K/W
Chopper - IGBT					
$V_{CE(sat)}$	$I_C = 75\text{ A}$ $V_{GE} = 15\text{ V}$ chiplevel	$T_j = 25^\circ\text{C}$	1.85	2.10	V
		$T_j = 150^\circ\text{C}$	2.25	2.45	V
V_{CE0}		$T_j = 25^\circ\text{C}$	0.8	0.9	V
		$T_j = 150^\circ\text{C}$	0.7	0.8	V
r_{CE}	$V_{GE} = 15\text{ V}$	$T_j = 25^\circ\text{C}$	14	16	mΩ
		$T_j = 150^\circ\text{C}$	21	22	mΩ
$V_{GE(th)}$	$V_{GE} = V_{CE}\text{ V}, I_C = 3\text{ mA}$	5	5.8	6.5	V
I_{CES}	$V_{GE} = 0\text{ V}$ $V_{CE} = 1200\text{ V}$	$T_j = 25^\circ\text{C}$	0.1	0.3	mA
		$T_j = 150^\circ\text{C}$			mA
Q_G	- 8 V...+ 15 V		425		nC
R_{Gint}	$T_j = 25^\circ\text{C}$		10.00		Ω

SKiiP 37NAB12T4V1

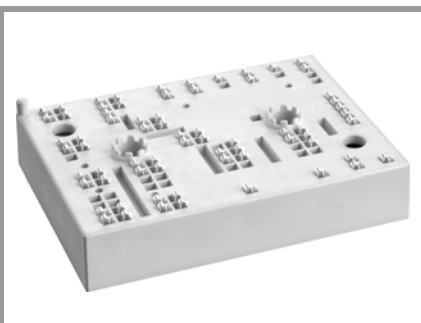

MiniSKiiP® 3

SKiiP 37NAB12T4V1

Features

- Trench 4 IGBTs
- Robust and soft freewheeling diodes in CAL technology
- Highly reliable spring contacts for electrical connections
- UL recognised file no. E63532

Typical Applications*

- Inverter up to 36 kVA
- Typical motor power 22 kW

Remarks

- V_{CEsat} , V_F = chip level value
- Case temp. limited to $T_C = 125^\circ\text{C}$ max. (for baseplateless modules $T_C = T_S$)
- product rel. results valid for $T_j \leq 150$ (recomm. $T_{op} = -40 \dots +150^\circ\text{C}$)

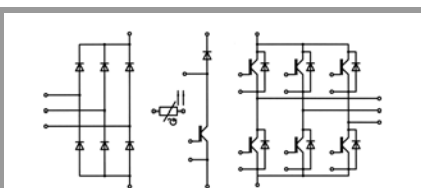

NAB

Characteristics						
Symbol	Conditions		min.	typ.	max.	Unit
Chopper - IGBT						
$t_{d(on)}$	$V_{CC} = 600\text{ V}$	$T_j = 150^\circ\text{C}$		150		ns
t_r	$I_C = 75\text{ A}$	$T_j = 150^\circ\text{C}$		35		ns
E_{on}	$R_{G\ on} = 2\ \Omega$	$T_j = 150^\circ\text{C}$		9.7		mJ
	$R_{G\ off} = 2\ \Omega$	$T_j = 150^\circ\text{C}$		355		ns
$t_{d(off)}$		$T_j = 150^\circ\text{C}$		60		ns
t_f		$T_j = 150^\circ\text{C}$		60		ns
E_{off}	$V_{GE} = +15/-15\text{ V}$	$T_j = 150^\circ\text{C}$		6.8		mJ
$R_{th(j-s)}$	per IGBT			0.58		K/W
Inverse - Diode						
$V_F = V_{EC}$	$I_F = 75\text{ A}$	$T_j = 25^\circ\text{C}$		2.2	2.5	V
	$V_{GE} = 0\text{ V}$ chiplevel	$T_j = 150^\circ\text{C}$		2.1	2.4	V
V_{F0}		$T_j = 25^\circ\text{C}$		1.3	1.5	V
		$T_j = 150^\circ\text{C}$		0.9	1.1	V
r_F		$T_j = 25^\circ\text{C}$		12	13	m Ω
		$T_j = 150^\circ\text{C}$		16	18	m Ω
I_{RRM}	$I_F = 75\text{ A}$	$T_j = 150^\circ\text{C}$		62		A
Q_{rr}	$di/dt_{off} = 1940\text{ A}/\mu\text{s}$	$T_j = 150^\circ\text{C}$		12.6		μC
E_{rr}	$V_{GE} = -15\text{ V}$ $V_{CC} = 600\text{ V}$	$T_j = 150^\circ\text{C}$		4.9		mJ
$R_{th(j-s)}$	per Diode			0.75		K/W
Freewheeling - Diode						
$V_F = V_{EC}$	$I_F = 75\text{ A}$	$T_j = 25^\circ\text{C}$		2.2	2.5	V
	$V_{GE} = 0\text{ V}$ chiplevel	$T_j = 150^\circ\text{C}$		2.1	2.4	V
V_{F0}		$T_j = 25^\circ\text{C}$		1.3	1.5	V
		$T_j = 150^\circ\text{C}$		0.9	1.1	V
r_F		$T_j = 25^\circ\text{C}$		12	13	m Ω
		$T_j = 150^\circ\text{C}$		16	18	m Ω
I_{RRM}	$I_F = 75\text{ A}$	$T_j = 150^\circ\text{C}$		62		A
Q_{rr}	$di/dt_{off} = 1940\text{ A}/\mu\text{s}$	$T_j = 150^\circ\text{C}$		12.6		μC
E_{rr}	$V_{GE} = -15\text{ V}$ $V_{CC} = 600\text{ V}$	$T_j = 150^\circ\text{C}$		4.9		mJ
$R_{th(j-s)}$	per Diode			0.75		K/W
Rectifier - Diode						
$V_F = V_{EC}$	$I_F = 25\text{ A}$	$T_j = 25^\circ\text{C}$		1	1.21	V
	$V_{GE} = 0\text{ V}$ chiplevel	$T_j = 125^\circ\text{C}$			1.1	V
V_{F0}		$T_j = 25^\circ\text{C}$			1.0	V
		$T_j = 125^\circ\text{C}$			0.8	V
r_F		$T_j = 25^\circ\text{C}$		4.8	9.3	m Ω
		$T_j = 125^\circ\text{C}$			11	m Ω
$R_{th(j-s)}$	per Diode			0.9		K/W
Module						
M_s	to heat sink			2	2.5	Nm
w				95		g
Temperatur Sensor						
R_{100}	$T_r = 100^\circ\text{C}$, tolerance = 3 %			1670 \pm 3%		Ω
$R(T)$	$R(T) = 1000\ \Omega [1 + A(T - 25^\circ\text{C}) + B(T - 25^\circ\text{C})^2]$ $A = 7.635 \cdot 10^{-3}\ \text{C}^{-1}$, $B = 1.731 \cdot 10^{-5}\ \text{C}^{-2}$					

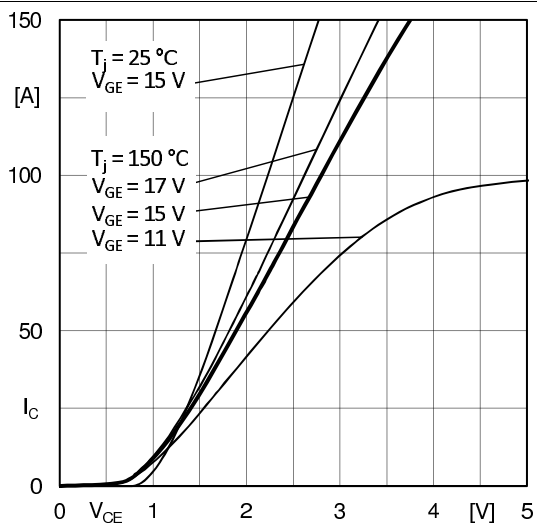

Fig. 1: Typ. output characteristic

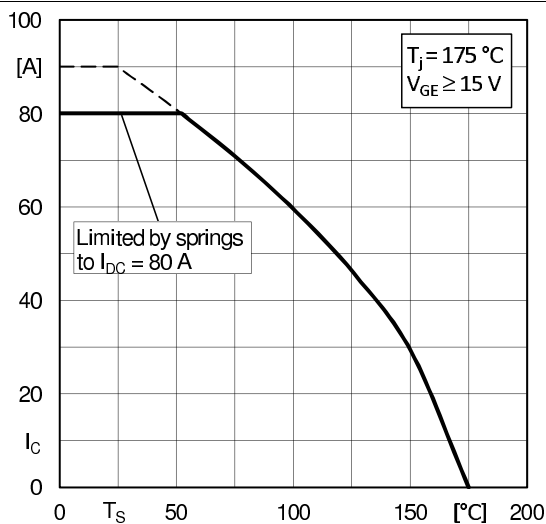

Fig. 2: Typ. rated current vs. temperature $I_C = f(T_S)$

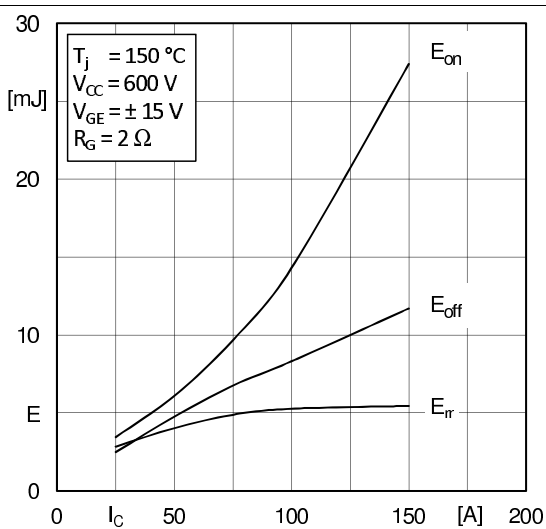

Fig. 3: Typ. turn-on /-off energy = f(Ic)

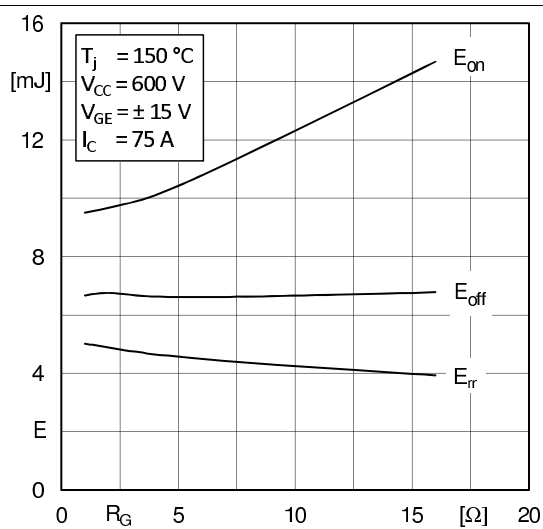

Fig. 4: Typ. turn-on /-off energy = f(RG)

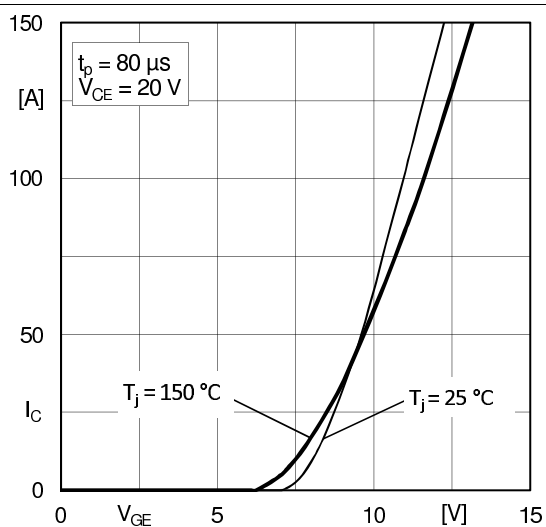

Fig. 5: Typ. transfer characteristic

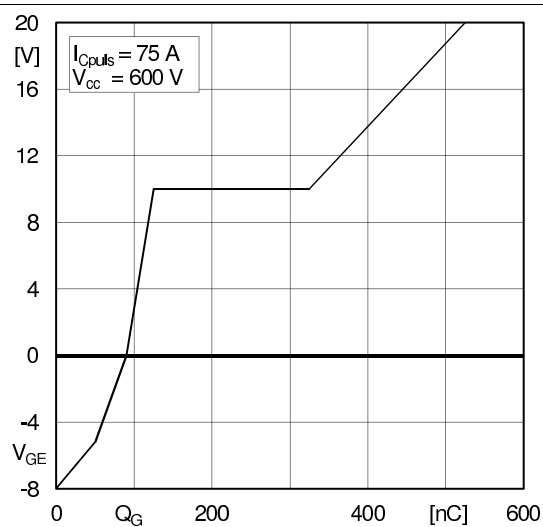
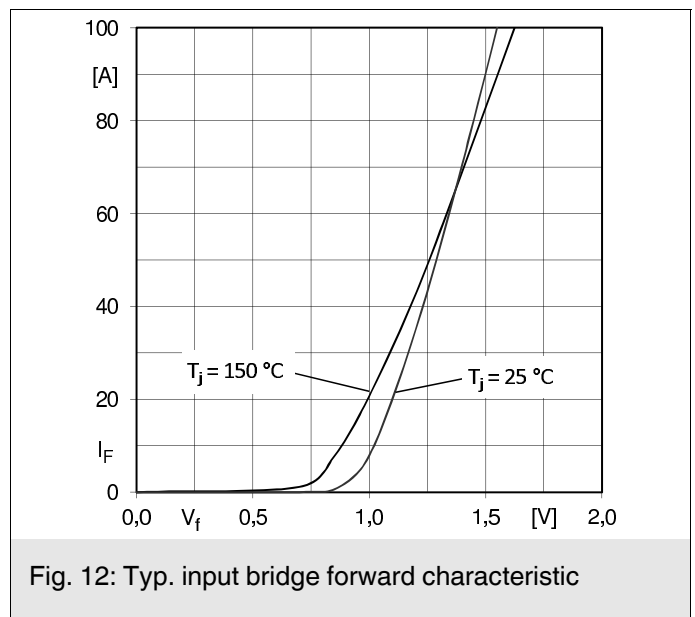
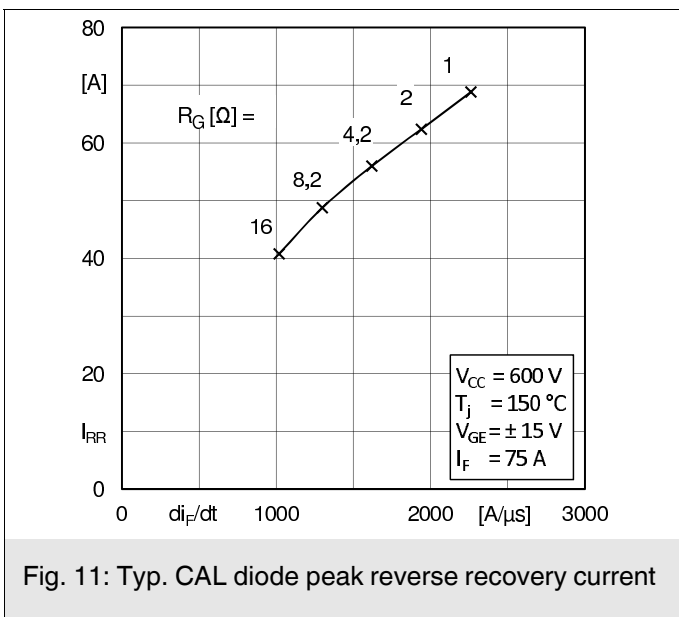
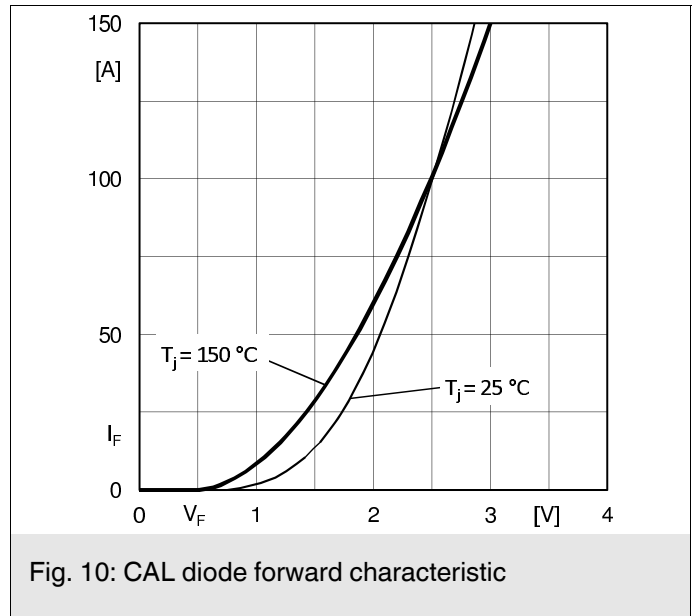
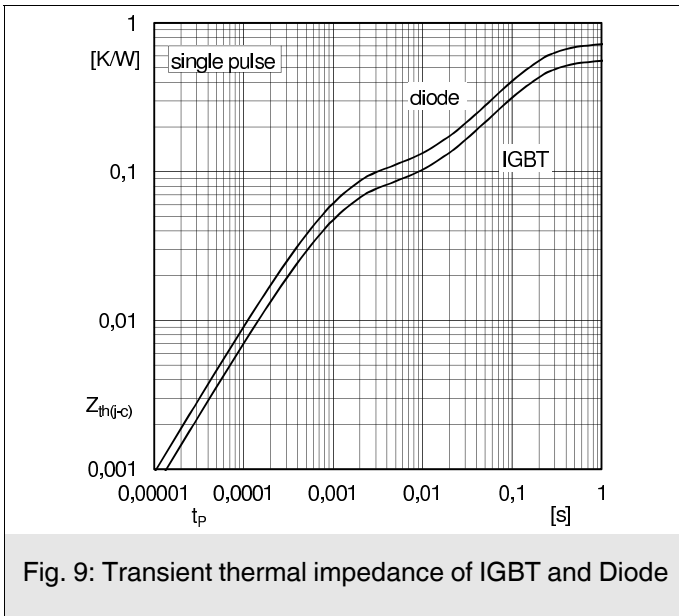
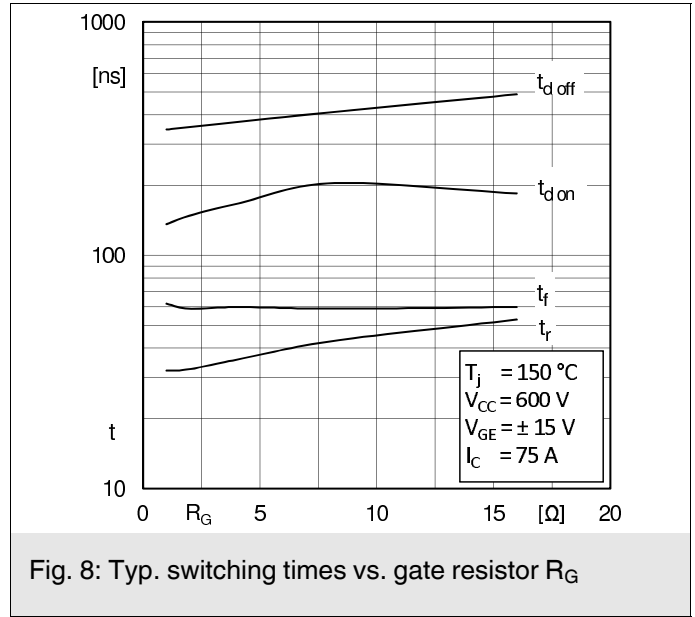
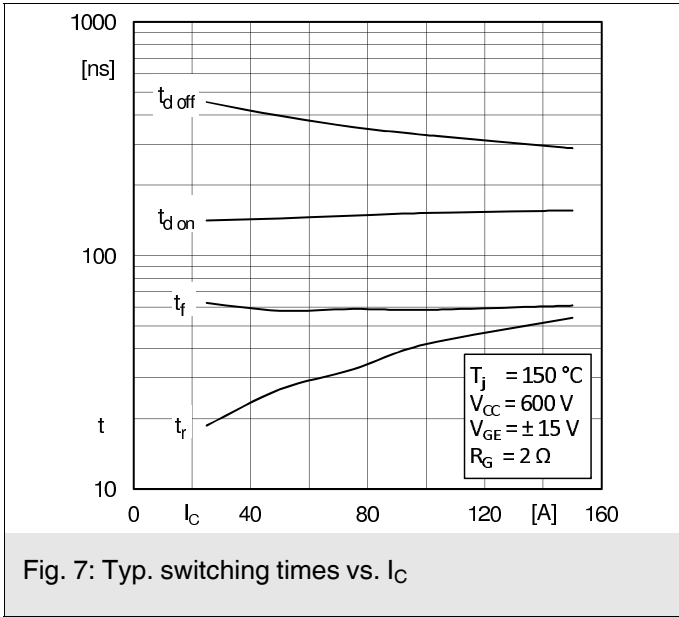
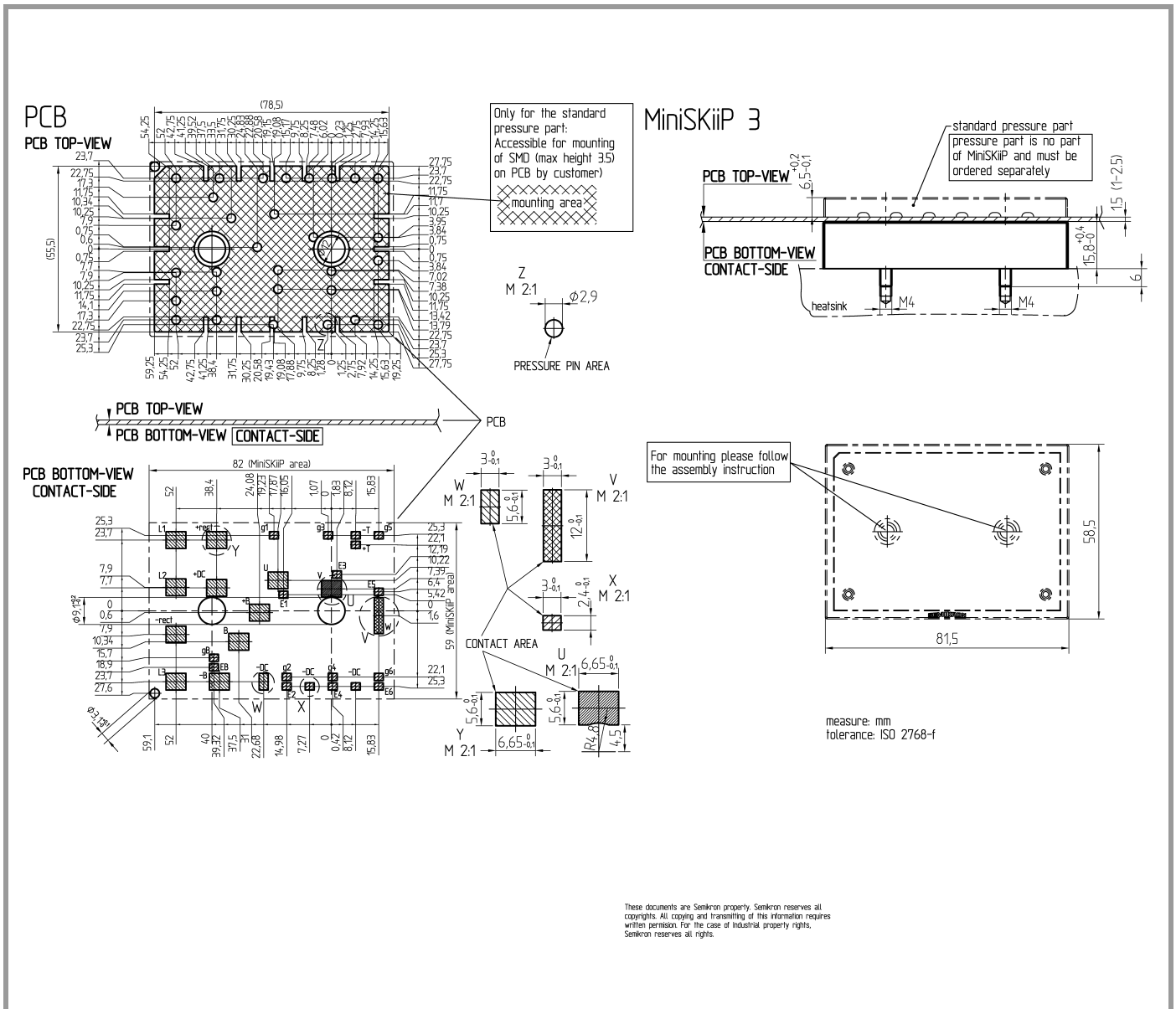

Fig. 6: Typ. gate charge characteristic



SKiiP 37NAB12T4V1



pinout, dimensions

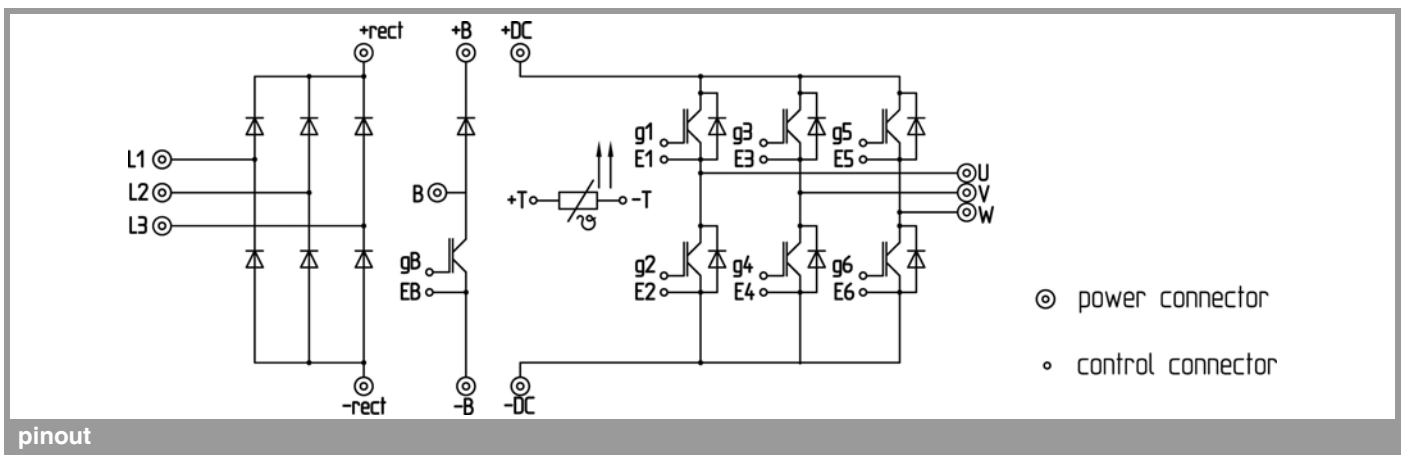

pinout

This is an electrostatic discharge sensitive device (ESDS), international standard IEC 60747-1, Chapter IX

* The specifications of our components may not be considered as an assurance of component characteristics. Components have to be tested for the respective application. Adjustments may be necessary. The use of SEMIKRON products in life support appliances and systems is subject to prior specification and written approval by SEMIKRON. We therefore strongly recommend prior consultation of our staff.