

SMD Block Type EMIFIL®**BNX02□H01□****Murata Standard Reference Specification [AEC-Q200]****1.Scope**

This reference specification applies to Block Type EMIFIL® BNX02□H01 Series for Automotive Electronics based on AEC-Q200.

2.Part Numbering

BN X 024 H 01 L
 Product ID Type Serial No. Category Features Packaging Code

(for Automotive Electronics) (L :Taping(φ178mm reel) / K :Taping(φ330mm reel) / B :Bulk)

3.Rating

Customer's Part Number	Part Number	Capacitance	Rated Voltage	Withstanding Voltage	Rated Current *	DC Resistance	Insulation Resistance	Insertion Loss	Voltage Drop	ESD Rank 2:2kV
	BNX024H01L	4.7μF ±15%	50V (DC)	125V (DC)	15A (DC)	0.43mΩ ±0.20mΩ	100MΩ min.	35dB min. (100kHz to 1GHz)	45 mV max.	2
	BNX024H01K									
	BNX024H01B									
	BNX025H01L	10μF ±15%	25V (DC)	62.5V (DC)	15A (DC)	0.43mΩ ±0.20mΩ	50MΩ min.	35dB min. (50 kHz to 1GHz)	45mV max.	
	BNX025H01K									
	BNX025H01B									
	BNX026H01L	10μF 10% ±20%	50V (DC)	125V (DC)	15A (DC)	0.43mΩ ±0.20mΩ	10MΩ min.	35dB min. (50KHz to 1GHz)	45mV max.	
	BNX026H01K									
	BNX026H01B									
	BNX027H01L	22μF 20% ±40%	16V (DC)	40V (DC)	15A (DC)	0.43mΩ ±0.20mΩ	1MΩ min.	35dB min. (40KHz to 1GHz)	45mV max.	
	BNX027H01K									
	BNX027H01B									

* Rated current is derated according to operating temperature.

- Operating Temperature : - 55 °C to + 125 °C
- Storage Temperature : - 55 °C to + 125 °C

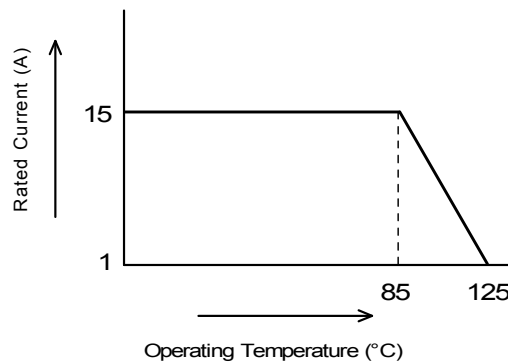
**4.Standard Testing Condition**

<Unless otherwise specified>

Temperature : Ordinary Temp. 15 °C to 35 °C
 Humidity : Ordinary Humidity 25 %(RH) to 85 %(RH)

<In case of doubt>

Temperature : 20 °C ± 2 °C
 Humidity : 60 %(RH) to 70 %(RH)
 Atmospheric pressure : 86kPa to 106kPa

5.Style and Dimensions

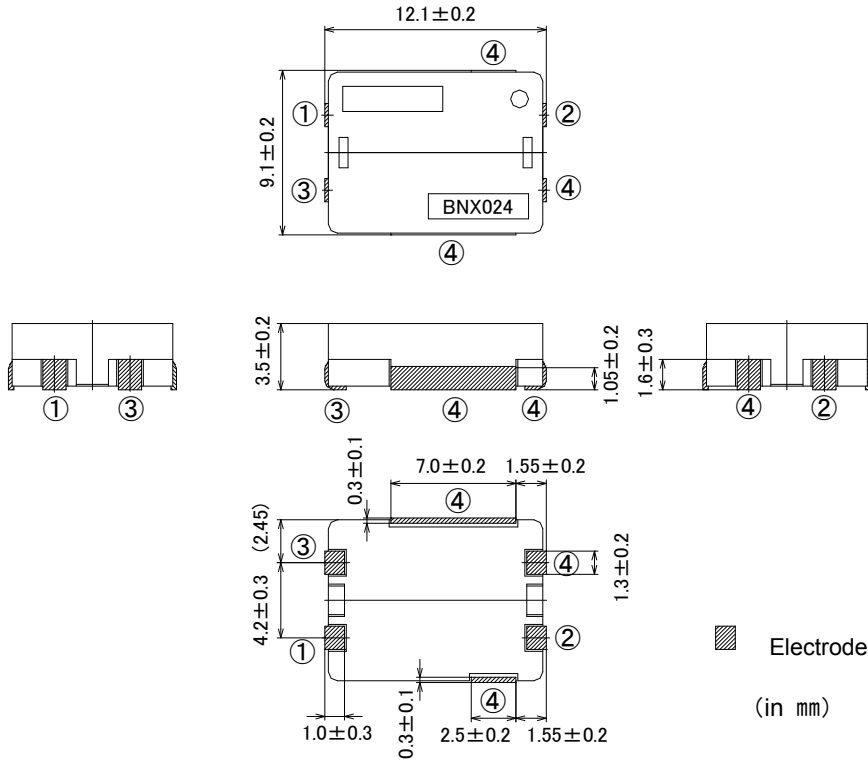

■ Equivalent Circuit

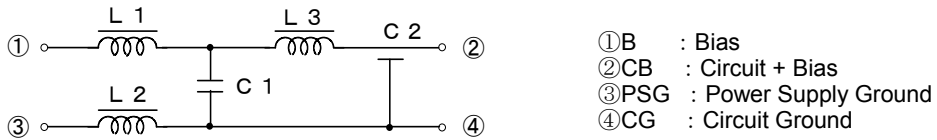

■ Unit Mass(Typical value)

0.86g

6.Marking

Filter shall be marked as follows.

- (1) Murata Mark : ***muRata***
- (2) Part Number : BNX024H01 : (**B N X 0 2 4**)
 BNX025H01 : (**B N X 0 2 5**)
 BNX026H01 : (**B N X 0 2 6**)
 BNX027H01 : (**B N X 0 2 7**)
- (3) Polarity Marking : ○

7.Electrical Performance

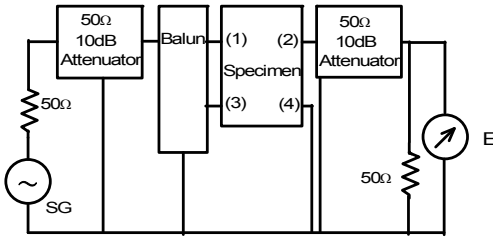
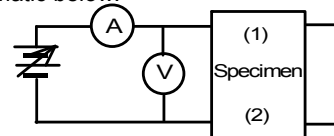
No.	Item	Specification	Test Method
7.1	Insertion Loss	Meet item 3.	 <p style="text-align: center;">*Method of measurement based on MIL-STD-220</p> <p>Insertion Loss = $-20 \log E_1/E_0$ (dB) E_0 : Level without FILTER (short) E_1 : Level with FILTER Measuring Equipment : Agilent 8753C or the equivalent</p>
7.2	Capacitance		<p>Measured by the following condition between Terminal ①② and ③④. (see item 5.) Frequency : 1 ± 0.1kHz (except BNX027) 120 ± 24kHz (BNX027) Voltage : 1 V(rms) max. (except BNX027) 0.5 ± 0.1V(rms) (BNX027) Measuring Equipment : HP 4278A or the equivalent (except BNX027) HP 4284A or the equivalent (BNX027)</p>
7.3	DC Resistance		<p>Measured by the way of 4 terminal method between① and ② and between ③ and ④. (see item 5.)</p>
7.4	Insulation Resistance		<p>Measured at DC rated voltage between terminal ①② and ③④. (see item 5.) Time : 60 s max Charging current : 50 mA max. Measuring Equipment : R8340A or the equivalent</p>
7.5	Withstanding Voltage	Filter shall be no failure.	<p>Withstanding voltage shall be applied between terminal ① ② and ③④. (see item 5.) Test Voltage : BNX024 125V(DC) BNX025 62.5V(DC) BNX026 125V(DC) BNX027 40V(DC) Time : 5 ± 1 s Charging current : 50 mA max.</p>
7.6	Voltage Drop	Meet item 3.	<p>After soldering the part on the test substrate, measure the voltage with passing the rated current as shown in the schematic below.</p>  <p>Where the terminals of the part shall be connected as follows: Referring to the terminal No. shown in item 5, connect terminal No. ② and ④ by soldering copper wire with diameter more than 1mm / length less than 6mm. Then connect terminal No. ① as (1) and terminal No. ③ as (2) the measurement circuit as mentioned above. The probe for measuring the voltage shall be touched on the solder fillet of ①③.</p>

8. Q200 Requirement

8-1. Performance (based on Table 13 for Ferrite EMI SUPPRESSORS/FILTERS)

AEC-Q200 Rev.D issued June. 1 2010

AEC-Q200			Murata Specification / Deviation
No.	Stress	Test Method	
3	High Temperature Exposure (Storage)	1000hours at 125C Set for 24hours at room temperature, then measured.	Meet Table A after testing.
4	Temperature Cycling	1000cycles(-55C to 125C) Measurement at 24±2 hours after test conclusion.	Meet Table A after testing.
5	Destructive Physical Analysis	Per EIA469 No electrical tests	Not Applicable
7	Biased Humidity	1000hours 85C/85%RH. Apply Maximum rated Voltage and current. Measurement at 24+/-2 hours after test conclusion.	Meet Table B after testing.
8	Operational Life	1000hours at 125C Apply Maximum rated Current. Measurement at 24+/-2 hours after test conclusion.	Meet Table A after testing.
9	External Visual	Visual inspection	No abnormalities
10	Physical Dimension	Meet ITEM 4 (Style and Dimensions)	No defects
12	Resistance to Solvents	Per MIL-STD-202 Method 215	Not Applicable
13	Mechanical Shock	Per MIL-STD-202 Method 213 Figure 1 of Method 213. Condition F(1500g's/0.5ms/Half sine) Three times each 6 direction.	Meet Table C after testing.
14	Vibration	5g's for 20 minutes, 12cycles each of 3 orientations Oscillation Frequency : 10-2000Hz.	Meet Table C after testing.
15	Resistance to Soldering Heat	No heating. 260C +/- degree C Immersion time 10s	Pre-heating: 150C+/-5C, 60s+/-5s Meet Table D after testing.
17	ESD	Per AEC-Q200-002	Meet Table C after testing. ESD Rank: Refer to Item 3. Rating.
18	Solderability	Per J-STD-002	Method b : Not Applicable 75% of the terminations is to be soldered.
19	Electrical Characterization	Measured :Capacitance	No defects
20	Flammability	Per UL-94	Not Applicable
21	Board Flex	Epoxy-PCB(1.6mm) Deflection 2mm(min) 60s minimum holding time	Meet Table D after testing.
22	Terminal Strength	Per AEC-Q200-006 A force of 17.7N for 60sec	17.7N for 60sec No defects
30	Electrical Transient Conduction	Per ISO-7637-2	Not Applicable

Table A

Appearance	No damaged
Capacitance Change	Within +/-12.5% (BNX024/BNX025) Within +/-15% (BNX026/BNX027)
I.R.	10M Ω min. (BNX024) 5M Ω min. (BNX025) 1M Ω min. (BNX024) 0.1M Ω min. (BNX025)

Table B

Appearance	No damaged
Capacitance Change	Within +/-12.5% (BNX024/BNX025) Within +/-15% (BNX026/BNX027)
I.R.	5M Ω min. (BNX024) 2.5M Ω min. (BNX025) 1M Ω min. (BNX024) 0.1M Ω min. (BNX025)

Table C

Appearance	No damaged
Capacitance Change	Within +/-15%
I.R.	100M Ω min. (BNX024) 50M Ω min. (BNX025) 10M Ω min. (BNX024) 1M Ω min. (BNX025)
Withstanding Voltage	No damaged

Table D

Appearance	No damaged
Capacitance Change	Within +/-7.5% (BNX024/BNX025) Within +/-15% (BNX026/BNX027)
I.R.	100M Ω min. (BNX024) 50M Ω min. (BNX025) 10M Ω min. (BNX024) 1M Ω min. (BNX025)
Withstanding Voltage	No damaged

<About BNX026,BNX027>

- Initial values: measured after heat treatment ($150 \pm 0_{10}^{\circ}\text{C}$, 1hour) and exposure in the room condition for 24 ± 2 hours.
- Values After Testing: measured after heat treatment ($150 \pm 0_{10}^{\circ}\text{C}$, 1hour) and exposure in the room condition for 24 ± 2 hours.

9.Insertion Loss Characteristics (I.L.) (Typ.)

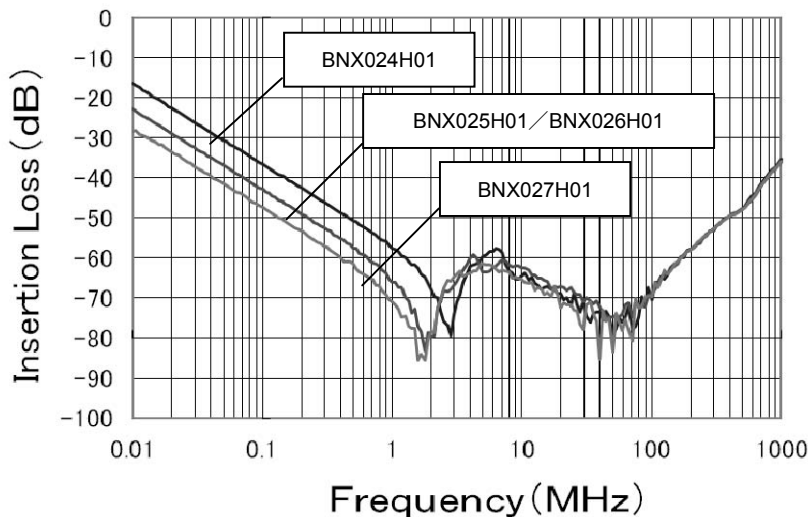

10. Specification of Packaging

10.1 Appearance and Dimensions (24mm-wide plastic tape)

(1) plastic tape

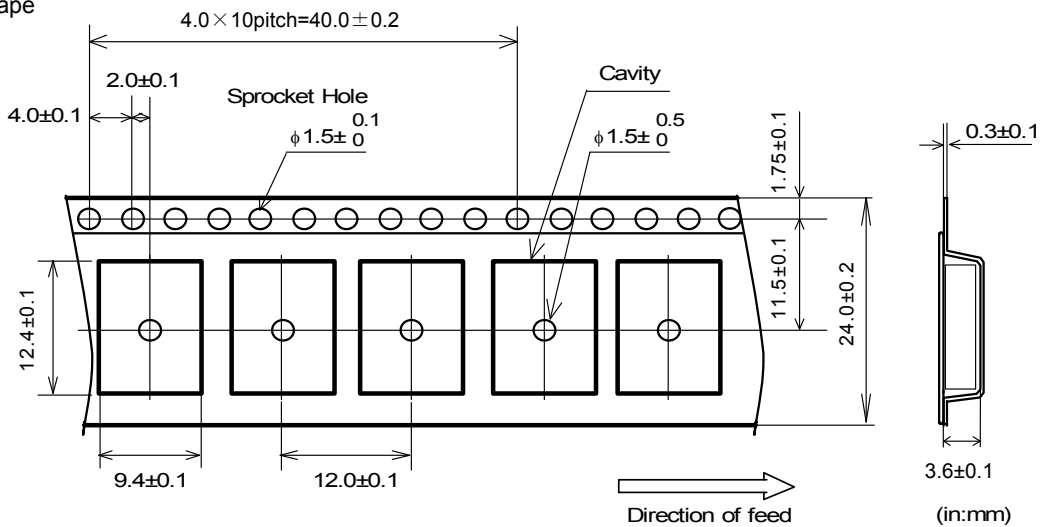

*Dimension of the Cavity is measured at the bottom side.

(2)Direction of the product

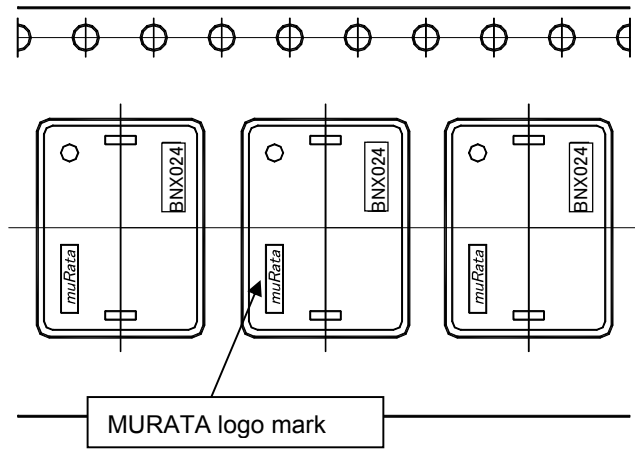

10.2 Specification of Taping

- (1) Packing quantity (standard quantity)
 - φ178mm reel : 400 pcs. / reel
 - φ330mm reel : 1500 pcs. / reel
- (2) Packing Method

Products shall be packaged in the cavity of the plastic tape and sealed with cover tape.
- (3) Spliced point

The cover tape have no spliced point.
- (4) Sprocket Hole

The sprocket holes are to the right as the tape is pulled toward the user.
- (5) Missing components number

Missing components number within 0.1% of the number per reel or 1 pc., whichever is greater, and are not continuous. The specified quantity per reel is kept.

10.3 Pull Strength of Plastic Tape and Cover Tape

Plastic tape	10N min.
Cover tape	

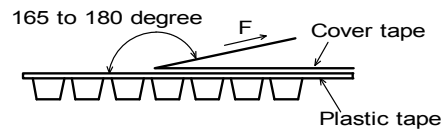

10.4 Peeling off force of Cover tape

0.2N to 0.7N (minimum value is typical)
 * Speed of Peeling off : 300 mm / min

10.5 Dimensions of Leader-tape, Trailer and Reel

There shall be leader-tape (top tape and empty tape) and trailer-tape (empty tape) as follows.

[Packaging Code:L (φ178mm reel)]

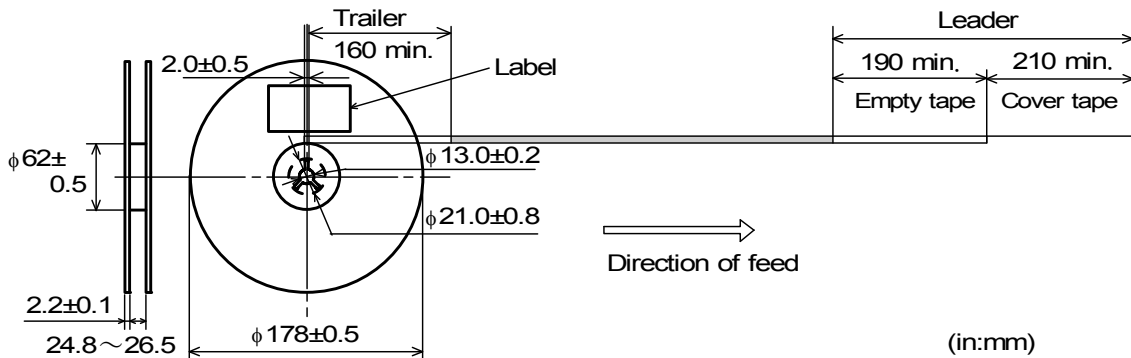

[Packaging Code:K (φ330mm reel)]

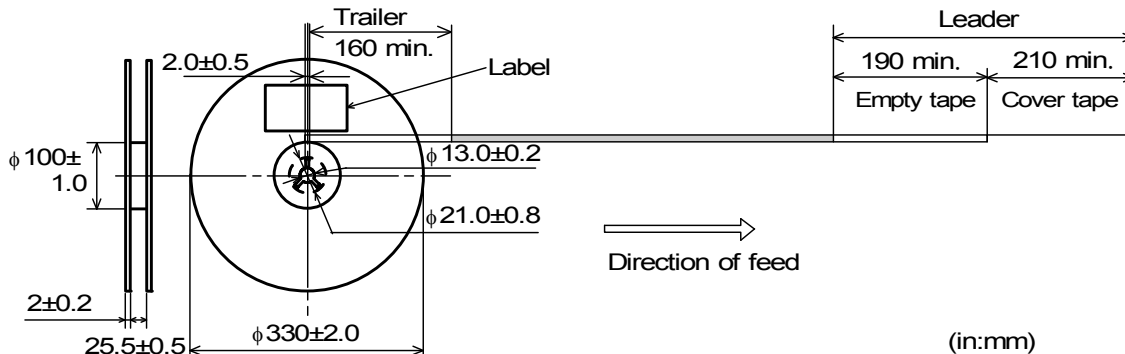

10.6 Marking for reel

Customer part number, MURATA part number, Inspection number(*1), RoHS marking(*2), Quantity, etc

*1) « Expression of Inspection No. »

□□ OOOO ×××
 (1) (2) (3)

(1) Factory Code

(2) Date

First digit : Year / Last digit of year

Second digit : Month / Jan. to Sep. → 1 to 9, Oct. to Dec. → O,N,D

Third, Fourth digit : Day

(3) Serial No.

*2) « Expression of RoHS marking »

ROHS – Y (△)
 (1) (2)

(1) RoHS regulation conformity parts.

(2) MURATA classification number

10.7 Marking for Outside package (corrugated paper box)

Customer name, Purchasing Order Number, Customer Part Number, MURATA part number, RoHS discrimination(*2), Quantity, etc

10.8 Specification of Outer Case

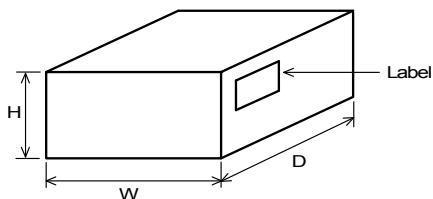

Reel	Outer Case Dimensions (mm)			Standard Reel Quantity in Outer Case (Reel)
	W	D	H	
φ178mm	186	186	93	3
φ330mm	340	340	85	2

* Above Outer Case size is typical. It depends on a quantity of an order.

11. ⚠ Caution

11.1 Operating Environment

Do not use this product under the following environmental conditions, on deterioration of the performance, such as insulation resistance may result from the use.

- (1) in the corrodible atmosphere (acidic gases, alkaline gases, chlorine, sulfur gases, organic gases and etc.)
- (2) in the atmosphere where liquid such as organic solvent, may splash on the products.
- (3) in the atmosphere where dust rises.
- (4) in the atmosphere where rapidly thermal change occurs.

11.2.Direction of mounting

Please make sure of the direction of mounting and connect to the circuit properly.

As shown in the equivalent circuit shown in item 5, this product has a directionality.

Wrong connection to the circuit may cause open/short circuit of the part, burnout and serious accidents.

11.3.Caution (Rating)

< Self-heating >

Though this product has a large rated current, following attention should be paid.

(1) Do not use this product beyond the ratings such as rated voltage and rated current/derating condition.

Then burnout may occurred by self-heating.

(2)After installing this product in your product, please make sure of the self-heating with the rated current.

11.4. Attention regarding product's lay out

< Attention regarding the heat generated by other products >

Please provide special attention when mounting products in close proximity to other products that radiate heat.

Failure to follow the above cautions may result, worst case, in a short circuit and cause fuming or firing when the product is used.

11.5. Fail-safe

Be sure to provide an appropriate fail-safe function on your product to prevent a second damage that may be caused by the abnormal function or the failure of our product.

11.6.ESD

ESD to this product, exceeding condition of IEC61000-4-2 with 30kV, may cause short circuit and fuming or firing.

11.7.Limitation of Applications

Please contact us before using our products for the applications listed below which require especially high reliability for the prevention of defects which might directly cause damage to the third party's life, body or property.

(1)Aircraft equipment (2)Aerospace equipment (3)Undersea equipment (4)Power plant control equipment

(5)Medical equipment (6)Transportation equipment(trains,ships,etc.) (7)Traffic signal equipment

(8)Disaster prevention / crime prevention equipment (9)Data-processing equipment

(10)Applications of similar complexity or with reliability requirements comparable to the applications listed in the above

12.Notice

Products can only be soldered with reflow.

This product is designed for solder mounting.

Please consult us in advance for applying other mounting method such as conductive adhesive.

12.1. Flux and Solder

Flux	Use rosin-based flux, Do not use highly acidic flux (with chlorine content exceeding 0.2(wt)%). Do not use water soluble flux.
Solder	Use Sn-3.0Ag-0.5Cu solder

Other flux (except above) Please contact us for details, then use.

12.2. Note for Assembling

<Exclusive Use of Reflow Soldering>

When installing by the flow soldering, the degradation of the insulation resistance sometimes occurs.
 Products can only be soldered with reflow.
 The use in flow soldering be reserved.

< Thermal Shock >

Pre-heating should be in such a way that the temperature difference between solder and products surface is limited to 100 °C max. Also cooling into solvent after soldering should be in such a way that the temperature difference is limited to 100 °C max.

Insufficient pre-heating may cause cracks on the ferrite, resulting in the deterioration of product quality.

12.3. Attention Regarding P.C.B. Bending

The following shall be considered when designing P.C.B.'s and laying out products.

(1) P.C.B. shall be designed so that products are not subject to the mechanical stress for board warpage.

[Products direction]

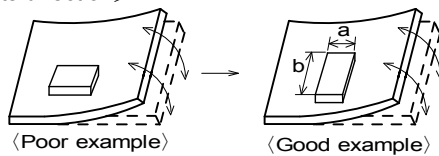

Products shall be located in the sideways direction (Length: $a < b$) to the mechanical stress.

(2) Products location on P.C.B. near seam for separation.

Products (A,B,C,D) shall be located carefully so that products are not subjected to the mechanical stress due to warping the board. Because they may be subjected to the mechanical stress in order of $A > C > B \cong D$.

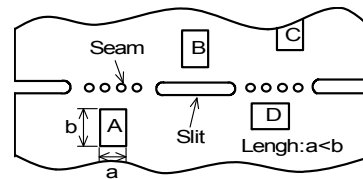

12.4. Attention Regarding P.C.B. Design

< The Arrangement of Products >

P.C.B. shall be designed so that products are far from the portion of perforation.

The portion of perforation shall be designed as narrow as possible, and shall be designed so as not to be applied the stress in the case of P.C.B. separation.

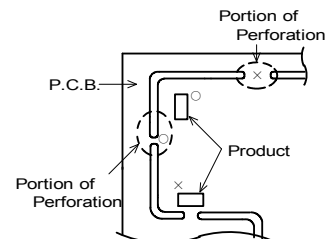

Products shall not be arranged on the line of a series of holes when there are big holes in P.C.B.
 (Because the stress concentrate on the line of holes.)

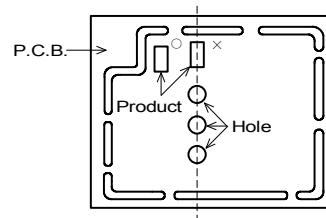

< Products Placing >

Support pins shall be set under P.C.B. to prevent causing a warp to P.C.B. during placing the products on the other side of P.C.B.

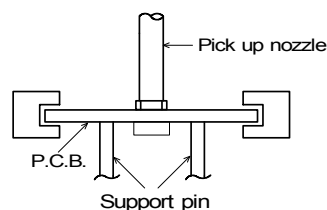

< P.C.B. Separation >

P.C.B. shall not be separated with hand.

P.C.B. shall be separated with the fixture so as not to cause P.C.B. bending.

12.5. Standard Land Dimensions

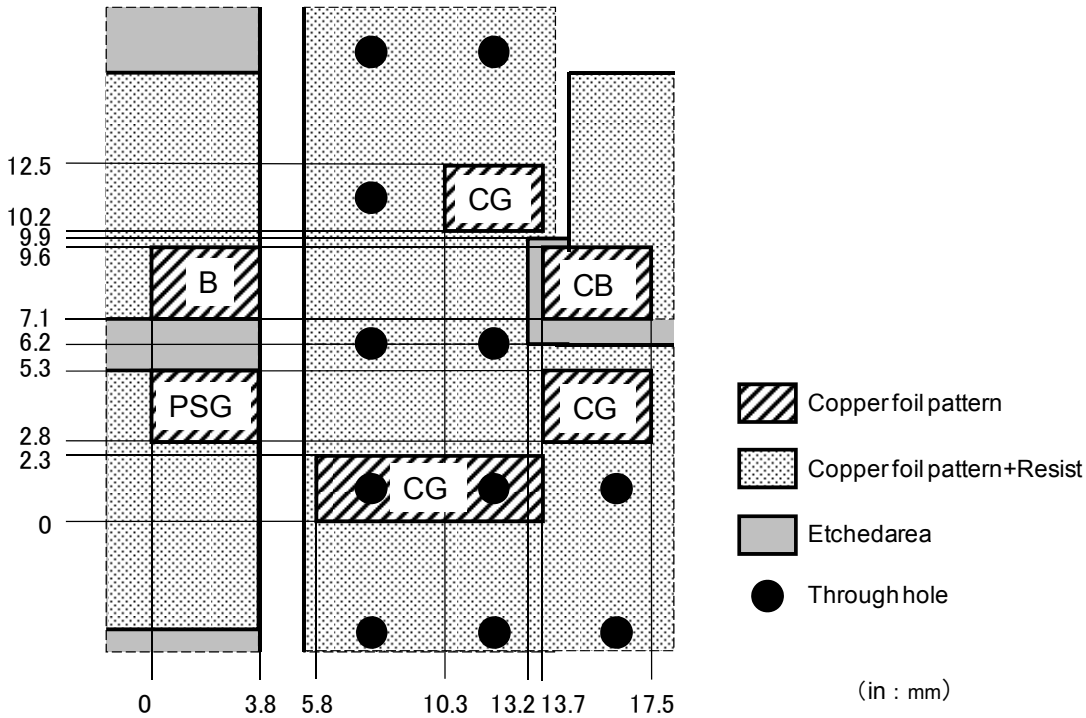

- (1) Design the land pads for this part as shown above on both side printed circuit board (or a multiple layered substrate).
- (2) This product is designed to meet large current.
Please design PCB pattern which is connected to this product not to become too hot by applied large current.
- (3) Ground area of CG should be connected to ground layer on the other side (or ground layer of multiple layered substrate) with through holes as shown above.
It is recommended to take the ground area as wide as possible.
- (4) It is recommended to use the connection to the ground layer with through holes and the ground layer to be circuit board wide.
- (5) Even in case that it isn't possible to use a both side printed circuit board (or a multiple layered substrate), the land pads for CG should be designed as wide as possible.

12.6. Reflow Soldering

- 1) Solder paste printing for reflow soldering
 - Standard thickness of solder paste should be 150 to 200 μm.
Incidentally, depending on the reflow condition and the way of heat conduction, the solder would not wet up the terminal, being possible to lead to not enough connection between terminals and lands on the circuit board / open circuit in the circuit board. In case of use, always evaluate this part in your products with actual use condition.
 - For the solder paste printing pattern, use standard land dimensions.
 - For the resist and copper foil pattern, use standard land dimensions.
 - Use Sn-3.0Ag-0.5Cu solder

2) Soldering Conditions

Standard soldering profile and the limit soldering profile is as follows.

The excessive soldering conditions may cause leaching of the electrode and/or resulting in the deterioration of product quality.

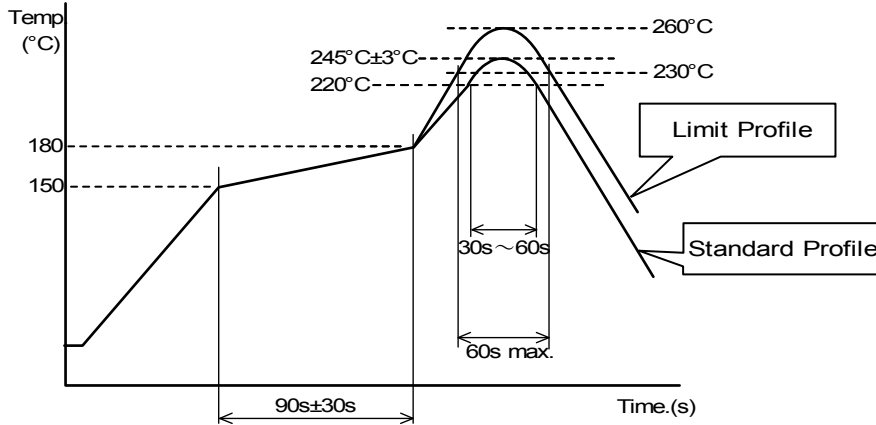

	Standard Profile	Limit Profile
Pre-heating	150°C ~ 180°C , 90s ± 30s	
Heating	above 220°C , 30s ~ 60s	above 230°C , 60s max.
Peak temperature	250°C ± 3°C	260°C , 10s
Cycle of reflow	2 times	2 times

12.7. Reworking with Soldering iron

The following conditions shall be strictly followed when using a soldering iron.

- Soldering iron : 100W max.
- Tip temperature/ Soldering time : 450°C ± 5°C, 5s

Note : Do not touch the products directly with the tip of the soldering iron.

12.8. Cleaning Conditions

Avoid cleaning product due to non-waterproof construction.
Please contact us for details, then use.

12.9. Moisture-proof coat material

Moisture-proof coating is made on inner parts of this product.

The Moisture-proof coat material might appear on the surface of product, which doesn't affect on the product performance.

12.10. Resin coating

The capacitance value may change and/or it may affect on the product's performance due to high cure-stress of resin to be used for coating / molding products. So please pay your careful attention when you select resin. In prior to use, please make the reliability evaluation with the product mounted in your application set.

1211. Handling of a substrate

After mounting products on a substrate, do not apply any stress to the product caused by bending or twisting to the substrate when cropping the substrate, inserting and removing a connector from the substrate or tightening screw to the substrate.

Excessive mechanical stress may cause cracking in the product.

Bending

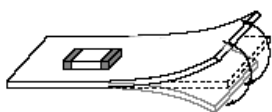

Twisting

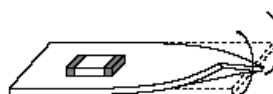

12.12 Storage condition

(1) Storage period

Use the products within 12 months after delivered.

Solderability should be checked if this period is exceeded.

(2) Storage environment condition

• Products should be stored in the warehouse on the following conditions.

Temperature : - 10 °C to + 40 °C

Humidity : 15 % to 85% relative humidity No rapid change on temperature and humidity

• Don't keep products in corrosive gases such as sulfur, chlorine gas or acid, or it may cause oxidization of electrode, resulting in poor solderability.

• Products should be stored on the palette for the prevention of the influence from humidity, dust and so on.

• Products should be stored in the warehouse without heat shock, vibration, direct sunlight and so on.

• Products should be stored under the airtight packaged condition.

(3) Delivery

Care should be taken when transporting or handling product to avoid excessive vibration or mechanical shock.

10.  Note

(1) Please make sure that your product has been evaluated in view of your specifications with our product being mounted to your product.

(2) You are requested not to use our product deviating from the agreed specifications.

(3) The contents of this reference specification are subject to change without advance notice. Please approve our product specifications or transact the approval sheet for product specifications before ordering.