

## AVO200-48S05

200 Watts

Eighth-brick Converter

**Total Power:** 200 Watts  
**Input Voltage:** 36 to 75 Vdc  
**# of Outputs:** Single

### Special Features

- Delivering up to 40A output
- Ultra-high efficiency 94.5% typ. at full load
- Wide input range: 36V ~ 75V
- Excellent thermal performance
- No minimum load requirement
- Basic isolation
- High power density
- Low output noise
- Reflow soldering-able
- RoHS 6 compliant
- Remote control function (negative logic)
- Remote output sense
- Trim function: 80% ~ 110%
- Input under voltage lockout
- Output over current protection
- Output short protection
- Output over voltage protection
- Over temperature protection
- Industry standard eighth-brick pin-out outline

### Safety

IEC/EN/UL/CSA 60950  
CE Mark  
UL/TUV



## Product Descriptions

The AVO200-48S05 is a single output DC/DC converter with standard eighth-brick form factor and pin configuration. It delivers up to 40A output current with 5V output. Ultra-high 94.5% efficiency and excellent thermal performance makes it an ideal choice for use in computing and telecommunication applications and can operate over an ambient temperature range of -40 °C ~ +85 °C.

## Applications

Telecom/ Datacom

## Model Numbers

Standard	Output Voltage	Structure	Remote ON/OFF logic	RoHS Status
AVO200-48S05-6L	5Vdc	Open-frame	Negative	R6
AVO200-48S05B-6L	5Vdc	Baseplate	Negative	R6

## Ordering information

AVO200	-	48	S	05	P	B	-	6	L
①		②	③	④	⑤	⑥		⑦	⑧

①	Model series	AVO: high efficiency eighth-brick series, 200: output power 200W
②	Input voltage	48: 36V ~ 75V input range, rated input voltage 48V
③	Output number	S: single output
④	Rated output voltage	05: 5V output
⑤	Remote ON/OFF logic	Default: negative logic; P: positive logic
⑥	Baseplate	B: with baseplate; default: open frame
⑦	Pin length	6: 3.8mm pin length S: SMT pin T: SMT pin and tape reel package
⑧	RoHS status	Y: Rohs, R5; L: RoHS, R6

## Options

None

## Electrical Specifications

### Absolute Maximum Ratings

Stress in excess of those listed in the “Absolute Maximum Ratings” may cause permanent damage to the power supply. These are stress ratings only and functional operation of the unit is not implied at these or any other conditions above those given in the operational sections of this TRN. Exposure to any absolute maximum rated condition for extended periods may adversely affect the power supply’s reliability.

Table 1. Absolute Maximum Ratings:

Parameter	Model	Symbol	Min	Typ	Max	Unit
Input Voltage Operating -Continuous Non-operating -100mS	All	$V_{IN,DC}$	-	-	80	Vdc
	All		-	-	100	Vdc
Maximum Output Power	All	$P_{O,max}$	-	-	200	W
Ambient Operating Temperature	All	$T_A$	-40	-	+85	°C
Storage Temperature	All	$T_{STG}$	-55	-	+125	°C
Voltage at remote ON/OFF pin	All		-0.3	-	5	Vdc
Humidity (non-condensing) Operating Non-operating	All		-	-	95	%
	All		-	-	95	%

## Input Specifications

Table 2. Input Specifications:

Parameter	Conditions	Symbol	Min	Typ	Max	Unit
Operating Input Voltage, DC	All	$V_{IN,DC}$	36	48	75	Vdc
Turn-on Voltage Threshold	$I_O = I_{O,max}$	$V_{IN,ON}$	31	-	36	Vdc
Turn-off Voltage Threshold	$I_O = I_{O,max}$	$V_{IN,OFF}$	30	-	35	Vdc
Lockout Voltage Hysteresis	$I_O = I_{O,max}$		1	-	3	V
Maximum Input Current ( $I_O = I_{O,max}$ )	$V_{IN,DC} = 36V_{DC}$	$I_{IN,max}$	-	-	7.5	A
Recommended Input Fuse	Fast blow external fuse recommended		-	-	12	A
Recommended External Input Capacitance	Low ESR capacitor recommended	$C_{IN}$	220	-	-	uF
Input Reflected Ripple Current	Through 12uH inductor		-	-	50	mA
Operating Efficiency	$T_A = 25^\circ C$ $I_O = I_{O,max}$ $I_O = 60\% I_{O,max}$	$\eta$	-	94.5	-	%
			-	94.5	-	%

## Output Specifications

Table 3. Output Specifications:

Parameter	Condition	Symbol	Min	Typ	Max	Unit	
Factory Set Voltage	$V_{IN,DC} = 48V_{DC}$ $I_O = I_{O,max}$	$V_O$	4.92	5.00	5.08	Vdc	
Total Regulation	Inclusive of line, load temperature change, warm-up drift	$V_O$	4.85	5.00	5.15	Vdc	
Output Voltage Line Regulation	All	$\%V_O$	-	-	0.2	%	
Output Voltage Load Regulation	All	$\%V_O$	-	-	0.5	%	
Output Voltage Temperature Regulation	All	$\%V_O$	-	-	0.02	$\%/^{\circ}C$	
Output Voltage Trim Range	All	$V_O$	4	-	5.5	V	
Output Ripple, pk-pk	Measure with a 1uF ceramic capacitor in parallel with a 10uF tantalum capacitor, 0 to 20MHz bandwidth	$V_O$	-	120	-	mV <sub>PK-PK</sub>	
Output Current	All	$I_O$	0	-	40	A	
Output DC current-limit inception <sup>1</sup>		$I_O$	44	-	60	A	
$V_O$ Load Capacitance <sup>2</sup>	All	$C_O$	220	1000	10000	uF	
$V_O$ Dynamic Response	Peak Deviation Settling Time	25% load change slew rate = 0.1A/us	$\pm V_O$	-	150	-	mV
		$T_s$	-	200	-	uSec	
		25% load change slew rate = 1A/us	$\pm V_O$	-	300	-	mV
			$T_s$	-	200	-	uSec
Turn-on transient	Rise time	$I_O = I_{max}$	$T_{rise}$	-	-	50	mS
	Turn-on delay time	$I_O = I_{max}$	$T_{turn-on}$	-	-	100	mS
	Output voltage overshoot	$I_O = 0$	$\%V_O$	-	-	5	%
Isolation Voltage	Input to outputs	1mA for 60s Slew rate of 1500V/10s		2250	-	-	Vdc
Switching frequency	All	$f_{sw}$	-	150	-	KHz	
Remote ON/OFF control (positive logic)	Off-state voltage	All		-0.3	-	1.2	V
	On-state voltage	All		3.5	-	5	V

Note 1 - Hiccup: auto-restart when over-current condition is removed.

Note 2 - High frequency and low ESR is recommended.

## Output Specifications

Table 3. Output Specifications, con't:

Parameter		Condition	Symbol	Min	Typ	Max	Unit
Remote ON/OFF control (Negative logic)	Off-state voltage	All		3.5	-	5	V
	On-state voltage	All		-0.3	-	1.2	V
Output over-voltage protection <sup>3</sup>		All	%V <sub>O</sub>	116	-	150	%
Output over-temperature protection <sup>4</sup>							
	With baseplate	All	T	100		125	°C
	Without baseplate	All	T	110	-	135	°C
Over-temperature hysteresis		All	T	5	-	-	°C
+ Sense		All	%V <sub>O</sub>	-	-	5	%
- Sense		All	%V <sub>O</sub>	-	-	5	%
MTBF		Telcordia SR-332-2006; 80% load, 300LFM, 40 °C T <sub>A</sub>		-	1.5	-	10 <sup>6</sup> h

Note 3 - Hiccup: auto-restart when over-voltage condition is removed.

Note 4 - Auto recovery.

## AVO200-48S05-6L Performance Curves

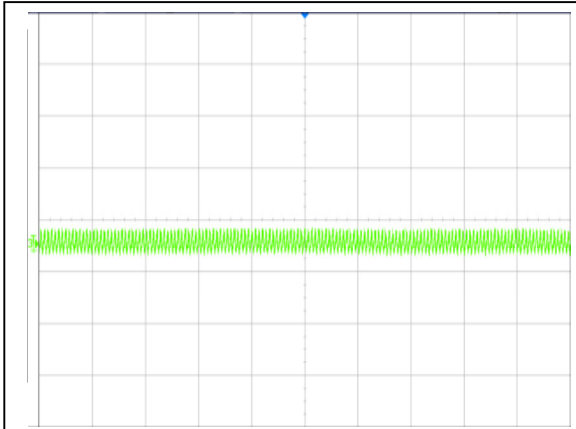

Figure 1: AVO200-48S05-6L Input Reflected Ripple Current Waveform  
 Vin = 48Vdc Load: Io = 40A  
 Ch 3: Iin (50uS/div, 50mA/div)

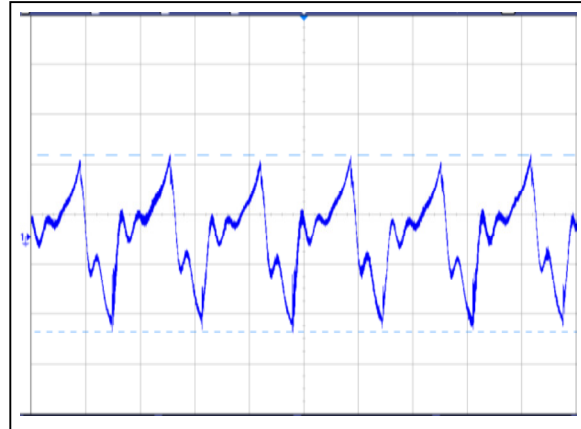

Figure 2: AVO200-48S05-6L Ripple and Noise Measurement  
 Vin = 48Vdc Load: Io = 40A  
 Ch 1: Vo (2us/div, 20mV/div)

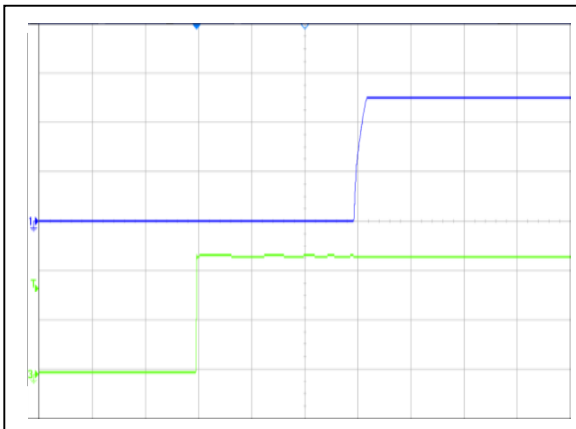

Figure 3: AVO200-48S05-6L Output Voltage Startup Characteristic  
 Vin = 36Vdc Load: Io = 40A (2mS/div)  
 Ch 1: Vo (2V/div) Ch 3: Vin (20V/div)

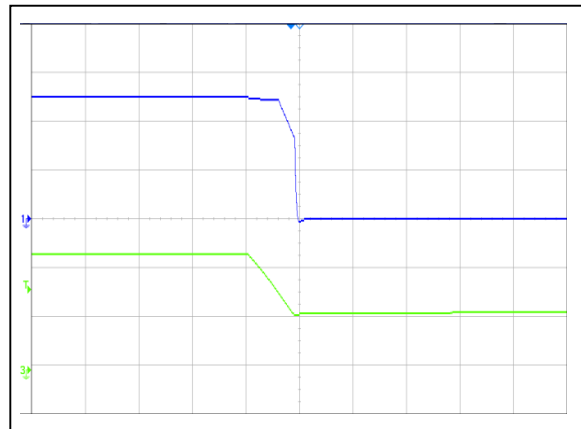

Figure 4: AVO200-48S05-6L Turn Off Characteristic (1mS/div)  
 Vin = 36Vdc Load: Io = 40A  
 Ch 1: Vo (2V/div) Ch 3: Vin (20V/div)

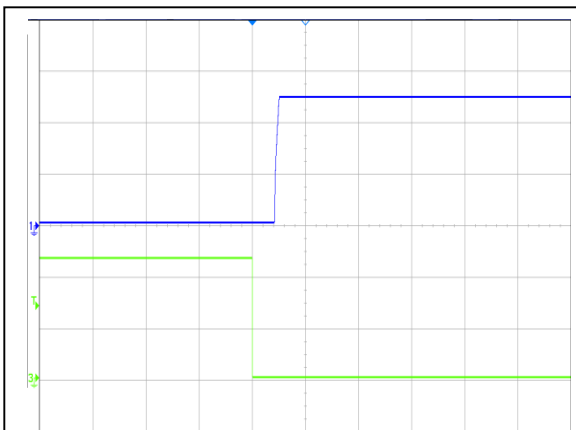

Figure 5: AVO200-48S05-6L Remote ON Waveform (50mS/div)  
 Vin = 36Vdc Load: Io = 40A  
 Ch 1: Vo (2V/div) Ch 3: Remote ON (2V/div)

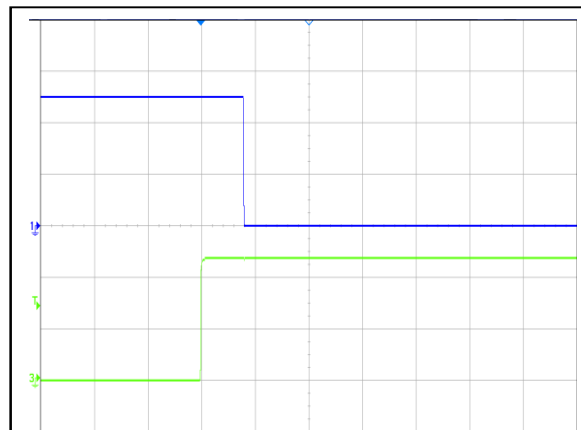

Figure 6: AVO200-48S05-6L Remote OFF Waveform (20mS/div)  
 Vin = 36Vdc Load: Io = 40A  
 Ch 1: Vo (2V/div) CH3: Remote OFF (2V/div)



## AVO200-48S05-6L Performance Curves

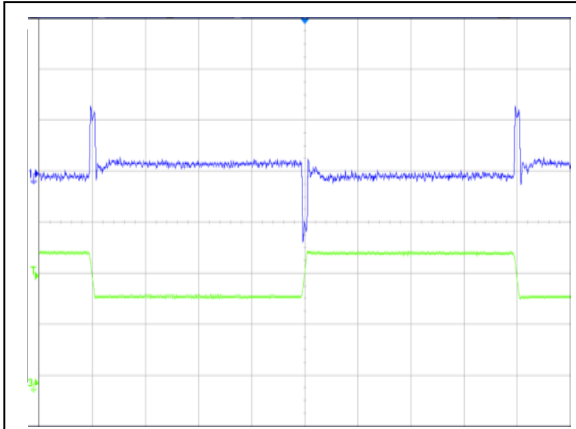

Figure 7: AVO200-48S05-6L Transient Response (1mS/div)  
 50%-75%-50% load change, 0.1A/uS slew rate, Vin = 48Vdc  
 Ch 1: Vo (10mV/div) Ch 3: Io (10A/div)

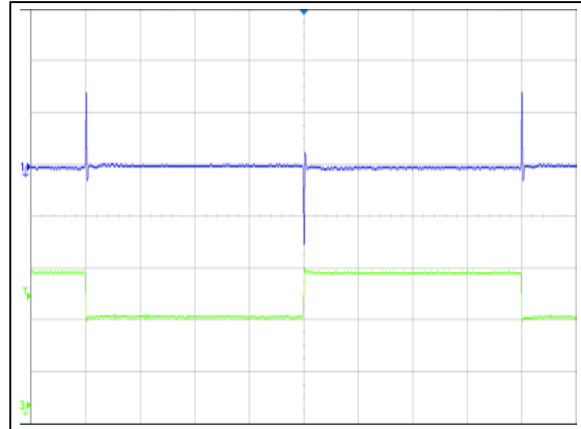

Figure 8: AVO200-48S05-6L Transient Response (1mS/div)  
 50%-75%-50% load change, 1A/uS slew rate, Vin = 48Vdc  
 Ch 1: Vo (100mV/div) Ch 3: Io (10A/div)

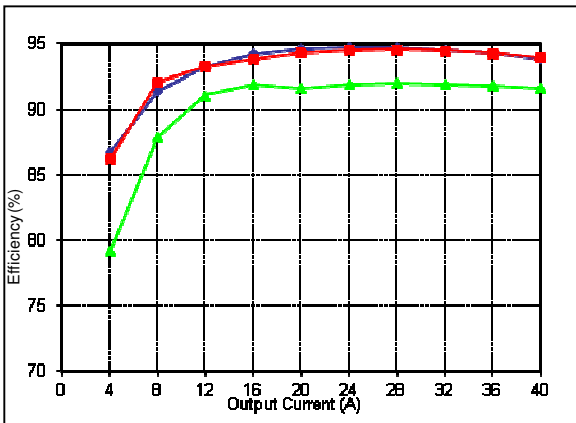

Figure 9: AVO200-48S05-6L Efficiency Curves @ 25 degC  
 ◆ 36Vdc ◆ 48Vdc ▲ 75Vdc  
 Loading: Io = 10% increment to 40A



## AVO200-48S05B-6L Performance Curves

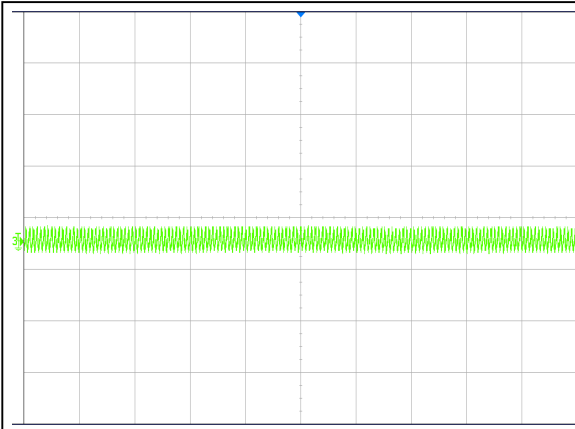

Figure 10: AVO200-48S05B-6L Input Reflected Ripple Current Waveform  
 Vin = 48Vdc Load: Io = 40A  
 Ch 3: Iin (50uS/div, 50mA/div)

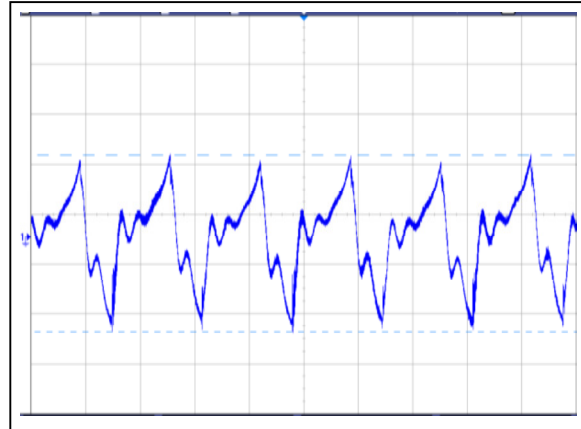

Figure 11: AVO200-48S05B-6L Ripple and Noise Measurement  
 Vin = 48Vdc Load: Io = 40A  
 Ch 1: Vo (2us/div, 20mV/div)

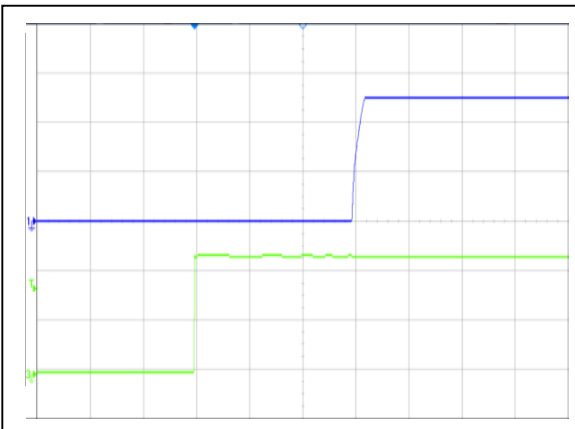

Figure 12: AVO200-48S05B-6L Output Voltage Startup Characteristic  
 Vin = 36Vdc Load: Io = 40A (2mS/div)  
 Ch 1: Vo (2V/div) Ch 3: Vin (20V/div)

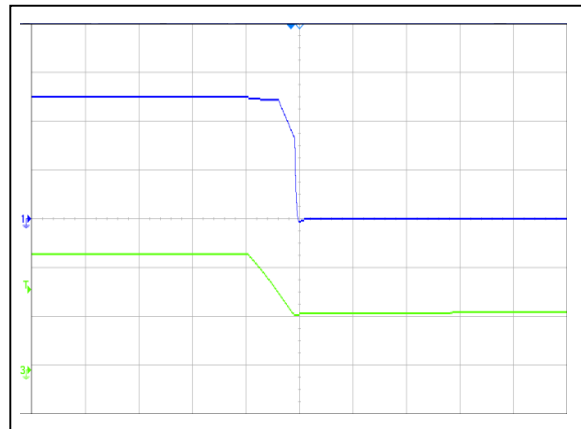

Figure 13: AVO200-48S05B-6L Turn Off Characteristic (1mS/div)  
 Vin = 36Vdc Load: Io = 40A  
 Ch 1: Vo (2V/div) Ch 3: Vin (20V/div)

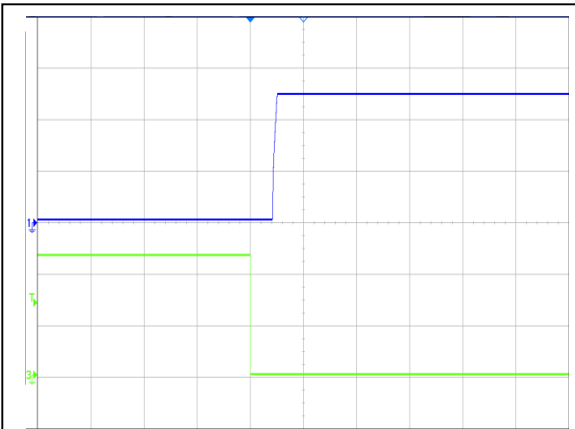

Figure 14: AVO200-48S05B-6L Remote ON Waveform (50mS/div)  
 Vin = 36Vdc Load: Io = 40A  
 Ch 1: Vo (2V/div) Ch 3: Remote ON (2V/div)

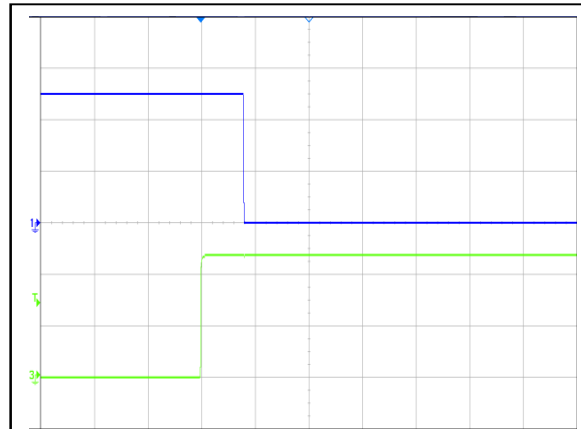

Figure 15: AVO200-48S05B-6L Remote OFF Waveform (20mS/div)  
 Vin = 36Vdc Load: Io = 40A  
 Ch 1: Vo (2V/div) CH3: Remote OFF (2V/div)

## AVO200-48S05-6L Performance Curves

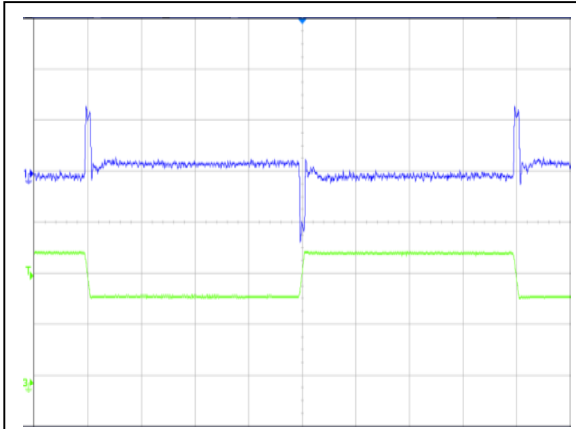

Figure 16: AVO200-48S05B-6L Transient Response (1mS/div)  
 50%-75%-50% load change, 0.1A/uS slew rate, Vin = 48Vdc  
 Ch 1: Vo (10mV/div) Ch 3: Io (10A/div)

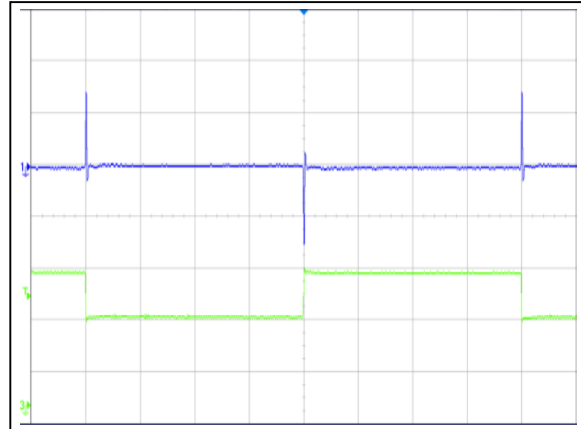

Figure 17: AVO200-48S05B-6L Transient Response (1mS/div)  
 50%-75%-50% load change, 1A/uS slew rate, Vin = 48Vdc  
 Ch 1: Vo (100mV/div) Ch 3: Io (10A/div)

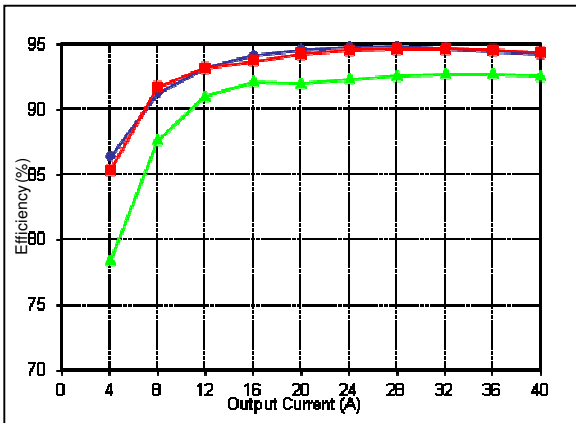

Figure 18: AVO200-48S05B-6L Efficiency Curves @ 25 degC  
 Loading: Io = 10% increment to 40A

## Mechanical Specifications

### Mechanical Outlines – Base plate Module

AVO200-48S05B-6L

### Pin Connections

- Pin 1 – +Vin
- Pin 2 – Remote On/Off
- Pin 3 – -Vin
- Pin 4 – -Vout
- Pin 5 – -Sense
- Pin 6 – Trim
- Pin 7 – +Sense
- Pin 8 – +Vout

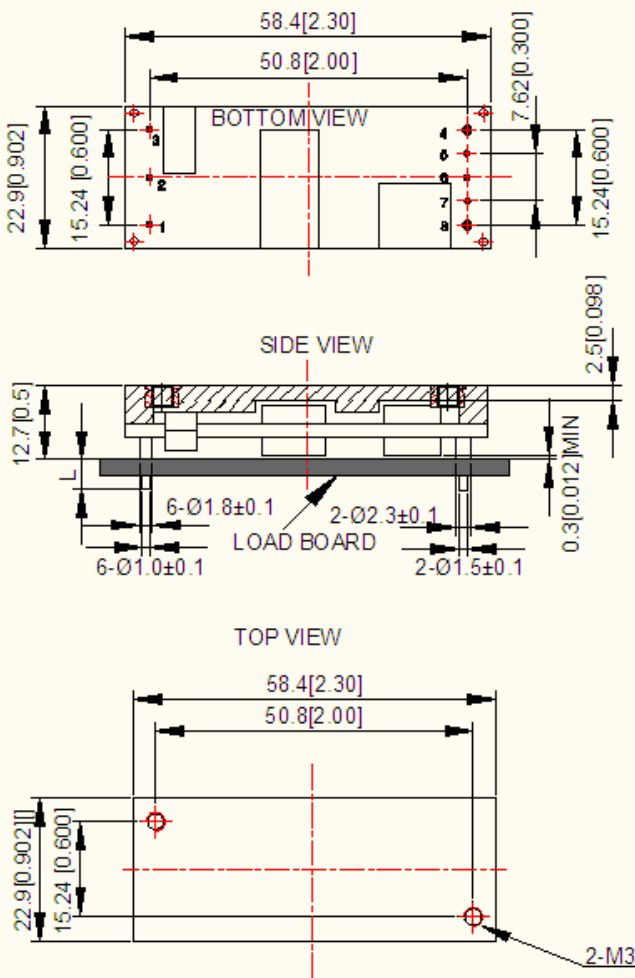

UNIT: mm[inch]      BOTTOM VIEW: pin on upside  
 TOLERANCE: X.Xmm±0.5mm[X.X in.±0.02in.]  
 X.XXmm±0.25mm[X.XX in.±0.01in.]

## Mechanical Outlines – Open-Frame Module

AVO200-48S05-6L

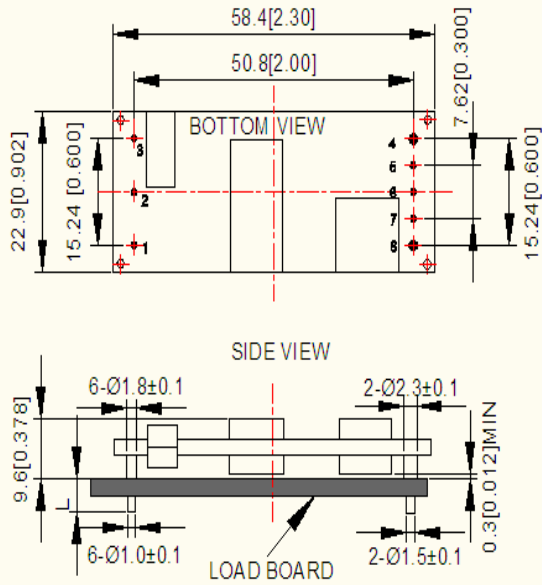

UNIT: mm[inch]      BOTTOM VIEW: pin on upside

TOLERANCE: X.Xmm±0.5mm[X.X in.±0.02in.]  
X.XXmm±0.25mm[X.XX in.±0.01in.]

## Pin Connections

- Pin 1 – +Vin
- Pin 2 – Remote On/Off
- Pin 3 – -Vin
- Pin 4 – -Vout
- Pin 5 – -Sense
- Pin 6 – Trim
- Pin 7 – +Sense
- Pin 8 – +Vout

## Pin length option

Device code suffix	L
-4	4.8mm ± 0.25 mm
-6	3.8mm ± 0.25 mm
-8	2.8mm ± 0.25 mm
None	5.8mm ± 0.25 mm

## Environmental Specifications

### EMC Immunity

AVO200-48S05-6L series power supply is designed to meet the following EMC immunity specifications:

Table 4. Environmental Specifications:

Document	Description
EN55022, Class A Limits	Conducted and Radiated EMI Limits
IEC/EN 61000-4-2, Level 3	Electromagnetic Compatibility (EMC) - Testing and measurement techniques - Electrostatic discharge immunity test. Enclosure Port
IEC/EN 61000-4-6, Level 2	Electromagnetic Compatibility (EMC) - Testing and measurement techniques, Continuous Conducted Interference. DC input port
IEC/EN 61000-4-4, Level3	Electromagnetic Compatibility (EMC) - Testing and measurement techniques, Electrical Fast Transient. DC input port.
IEC/EN 61000-4-5	Electromagnetic Compatibility (EMC) - Testing and measurement techniques, Immunity to surges - 600V common mode and 600V differential mode for DC ports
EN61000-4-29	Electromagnetic Compatibility (EMC) - Testing and measurement techniques, Voltage Dips and short interruptions and voltage variations. DC input port

### EMC Test Conditions

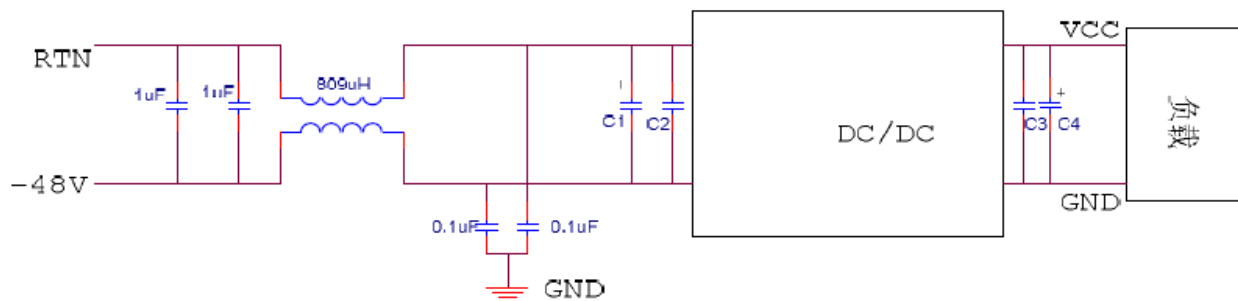

Figure 10 EMC test configuration

U1: Module to test, AVO200

C1 ~ C4: See Figure 12

## EMI Emissions

The AVO200-48S05 series has been designed to comply with the Class A limits of EMI requirements of EN55022 (FCC Part 15) and CISPR 22 (EN55022) for emissions and relevant sections of EN61000 (IEC 61000) for immunity. The unit is enclosed inside a metal box, tested at 200W using resistive load.

## Conducted Emissions

The applicable standard for conducted emissions is EN55022 (FCC Part 15). Conducted noise can appear as both differential mode and common mode noise currents. Differential mode noise is measured between the two input lines, with the major components occurring at the supply fundamental switching frequency and its harmonics. Common mode noise, a contributor to both radiated emissions and input conducted emissions, is measured between the input lines and system ground and can be broadband in nature.

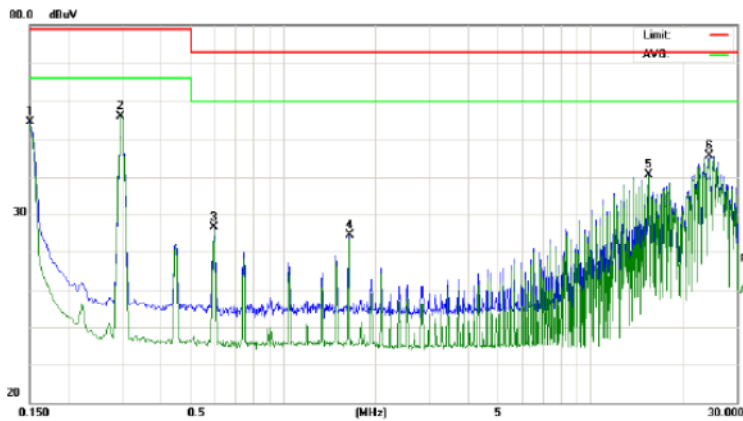

The AVO200-48S05 power supplies have internal EMI filters to ensure the converters' conducted EMI levels comply with EN55022 (FCC Part 15) Class A and EN55022 (CISPR 22) Class A limits. The EMI measurements are performed with resistive loads at maximum rated loading.

Sample of EN55022 Conducted EMI Measurement at 36Vdc input

Note: Red Line refers to Emerson Quasi Peak margin, which is 6dB below the CISPR international limit. Green Line refers to the Emerson Average margin, which is 6dB below the CISPR international limit.

## Conducted Emissions

Table 5. Conducted EMI emission specifications of the AVO200-48S05 series

Parameter	Model	Symbol	Min	Typ	Max	Unit
FCC Part 15, class A	All	Margin	-	-	6	dB
CISPR 22 (EN55022) class A	All	Margin	-	-	6	dB

## **Safety Certifications**

The AVO200-48S05-6L power supply is intended for inclusion in other equipment and the installer must ensure that it is in compliance with all the requirements of the end application. This product is only for inclusion by professional installers within other equipment and must not be operated as a stand alone product.

Table 6. Safety Certifications for AVO200-48S05-6L series power supply system

<b>Document</b>	<b>File #</b>	<b>Description</b>
UL/CSA 60950		US and Canada Requirements
EN60950		European Requirements
IEC60950		International Requirements
CE		CE Marking



**Operating Temperature**

The AVO200 series power supplies will start and operate within stated specifications at an ambient temperature from -40 °C to 85 °C under all load conditions. The storage temperature is -55 °C to 125 °C.

**Thermal Considerations – Open-frame module**

The converter is designed to operate in different thermal environments and sufficient cooling must be provided. Proper cooling of the DC/DC converter can be verified by measuring the temperature at the test point as shown in the Figure 11. The temperature at this point should not exceed the max values in the table 7.

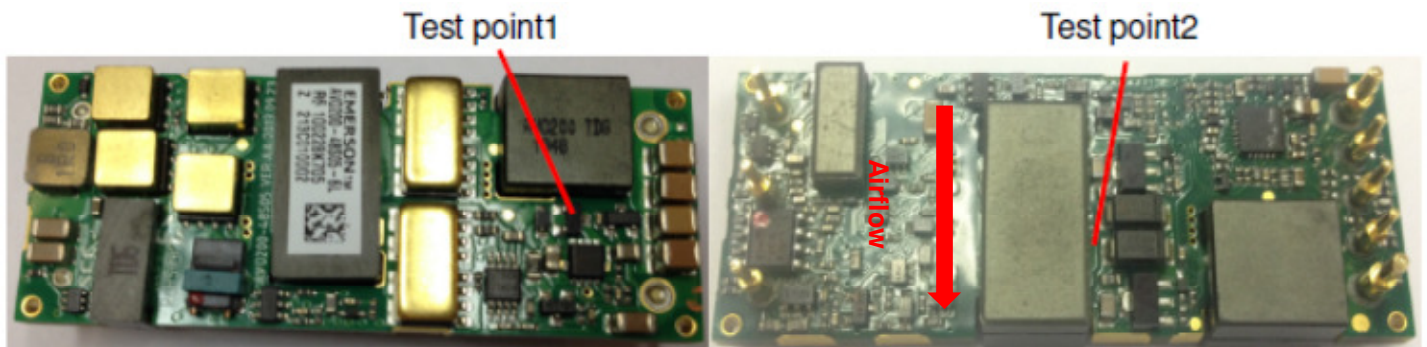

Figure 11 Temperature test point

Table 7. Temperature limit of the test point

Test Point	Temperature Limit
Test point 1	130 °C
Test point 2 (PCB)	130 °C

For a typical application, figure 12 shows the derating of output current vs. ambient air temperature at different air velocity.

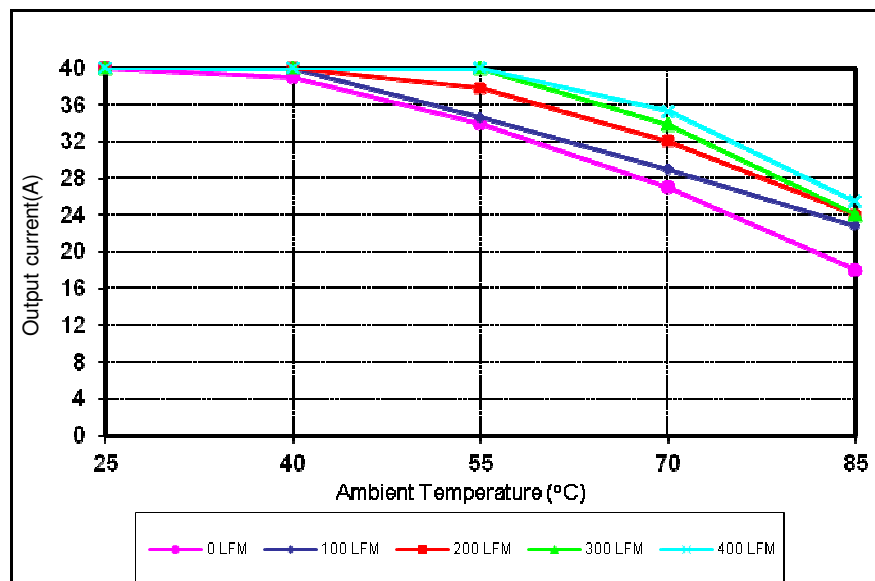

Figure 12 Output power derating, 48Vin, air flowing across the converter from pin 3 to pin 1

**Thermal Considerations –Base plate module**

The converter can both operate in two different modes.

Mode 1: The converter can operate in a enclosed environment without forced air convection. Cooling of the converter is achieved mainly by conduction from the baseplate to a heat sink. The converter can deliver full output power at 85 °C ambient temperature provided the baseplate temperature is kept the max values 100 °C.

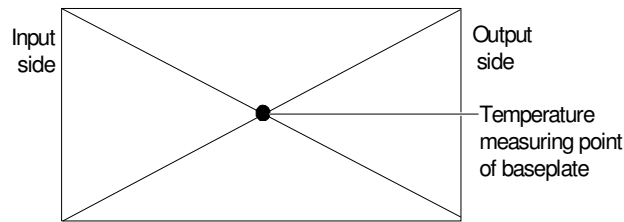

Figure 13 Temperature test point on base plate

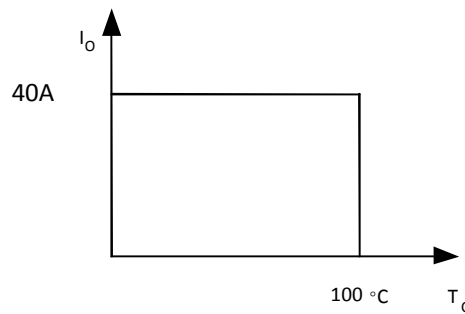

Figure 14 Output power derating curve, Tc: temperature test point on baseplate, see Figure 15

Mode 2: The converter is designed to operate in different thermal environments and sufficient cooling must be provided. Proper cooling of the DC/DC converter can be verified by measuring the temperature at the test point as shown in the Figure 15. The temperature at this point should not exceed the max values in the table 8.

Test point on base plate

Test point on PCB



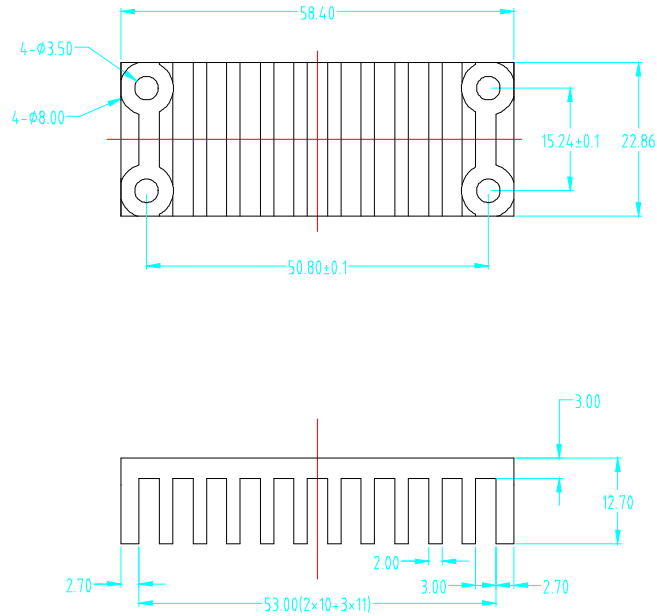

Figure 15 Temperature test point & heat sink mechanical diagram

Table 8. Temperature limit of the test point

Test Point	Temperature Limit
Test point on PCB	128 °C
Test point on base plate	114 °C

For a typical application, figure 16 shows the derating of output current vs. ambient air temperature at different air velocity.

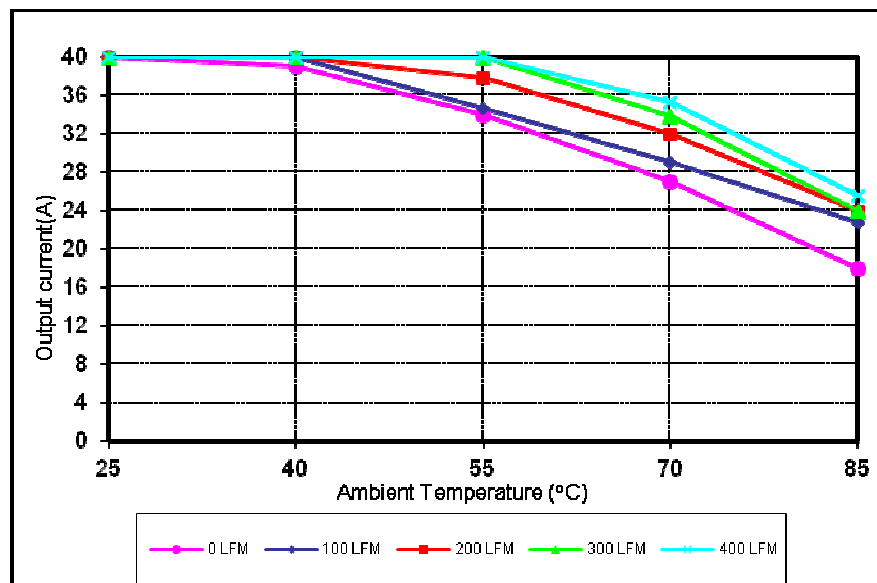

Figure 16 Output power derating, 48VIn, air flowing across the converter (from pin 3 to pin1)

## Qualification Testing

Table 9. Qualification testing

Parameter	Unit (pcs)	Test condition
Halt test	4-5	$T_{a,min} - 30\text{ }^{\circ}\text{C}$ to $T_{a,max} + 25\text{ }^{\circ}\text{C}$ , $10\text{ }^{\circ}\text{C}$ step, $V_{in} = \text{min to max}$ , $0 \sim 100\%$ load
Vibration	3	Frequency range: $5\text{Hz} \sim 20\text{Hz}$ , $20\text{Hz} \sim 200\text{Hz}$ , A.S.D: $1.0\text{m}^2/\text{s}^3$ , $-3\text{db/oct}$ , axes of vibration: X/Y/Z. Time: 30min/axes
Mechanical Shock	3	30g, 6ms, 3axes, 6directions, 3time/direction
Thermal Shock	3	$-55\text{ }^{\circ}\text{C}$ to $125\text{ }^{\circ}\text{C}$ , unit temperature 20cycles
Thermal Cycling	3	$-40\text{ }^{\circ}\text{C}$ to $85\text{ }^{\circ}\text{C}$ , temperature change rate: $1\text{ }^{\circ}\text{C}/\text{min}$ , cycles: 2cycles
Humidity	3	$40\text{ }^{\circ}\text{C}$ , 95%RH, 48h
Solder Ability	15	IPC J-STD-002C-2007

## Application Notes

### Typical Application

Below is the typical application of the AVO200 series power supply.

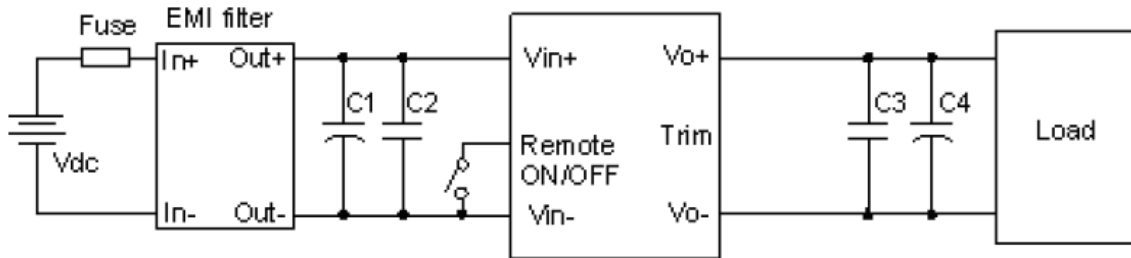

Figure 17 Typical application

C1: 220uF/100V electrolytic capacitor, P/N: UPM2A221MPD (Nichicon) or equivalent caps

C2, C3: 1uF/100V X7R ceramic capacitor, P/N: C3216X7R2A105KT0L0S(TDK) or equivalent caps

C4: 1000uF electrolytic capacitor, P/N: UPM1A102MHD (Nichicon) or equivalent caps

Fuse: External fast blow fuse with a rating of 12A. The recommended fuse model is 0314012.P from LITTLEFUSE.

**Remote ON/OFF**

Negative remote ON/OFF logic is available in AVO200-48S05. The logic is CMOS and TTL compatible. The voltage between pin Remote ON/OFF and pin Vin- must not exceed the range listed in table 3 to ensure proper operation. The external Remote ON/OFF circuit is highly recommended as shown in figure 18.

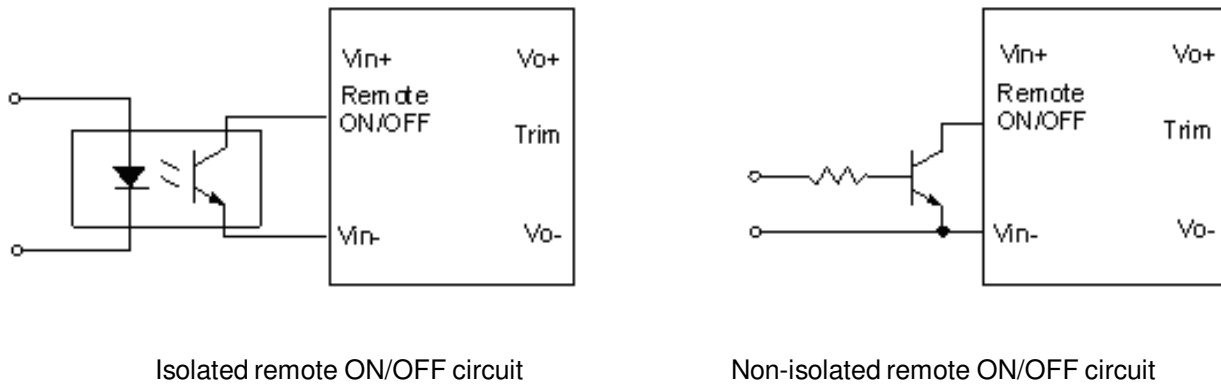

Figure 18 External Remote ON/OFF circuit

## Trim Characteristics

Connecting an external resistor between Trim pin and Vo- pin will decrease the output voltage. While connecting it between Trim and Vo+ will increase the output voltage. The following equations determine the external resistance to obtain the trimmed output voltage.

$$R_{adj-down} = \frac{510}{\Delta} - 10.2(K\Omega)$$

$$R_{adj-up} = \frac{5.1 \times V_{nom} \times (100 + \Delta)}{1.225 \times \Delta} - \frac{510}{\Delta} - 10.2(K\Omega)$$

$\Delta$ : Output error rate against nominal output voltage.

$$\Delta = \frac{100 \times (V_{nom} - V_0)}{V_{nom}}$$

$V_{nom}$ : Nominal output voltage.

For example, to get 5.5V output, the trimming resistor is

$$\Delta = \frac{100 \times (V_{nom} - V_0)}{V_{nom}} = \frac{100 \times (5.5 - 5)}{5} = 10$$

$$R_{adj-up} = \frac{5.1 \times 5 \times (100 + 10)}{1.225 \times 10} - \frac{510}{10} - 10.2 = 167.8(K\Omega)$$

When trimming up, the output current should be decreased accordingly so as not to exceed the maximum output power and the minimum input voltage should be increased as shown in below figure.

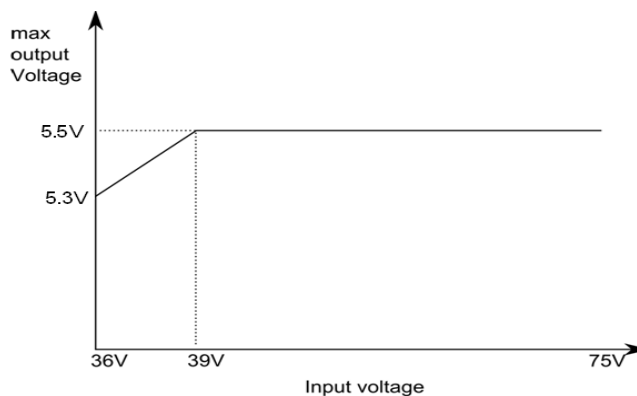

Figure 19 Max. adjustable output voltage vs. input voltage



Internal side

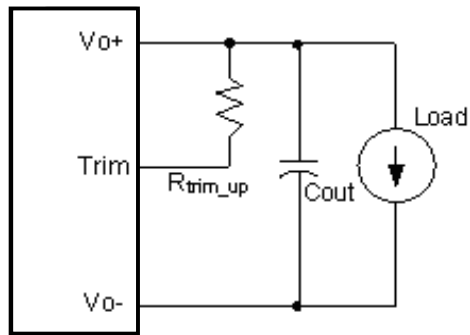

Figure 20 Trim up

Internal side

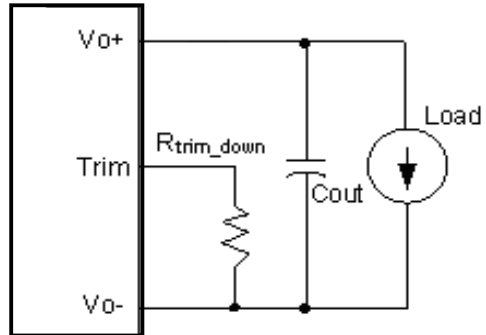

Figure 21 Trim down

**Input Ripple & Output Ripple & Noise Test Configuration**

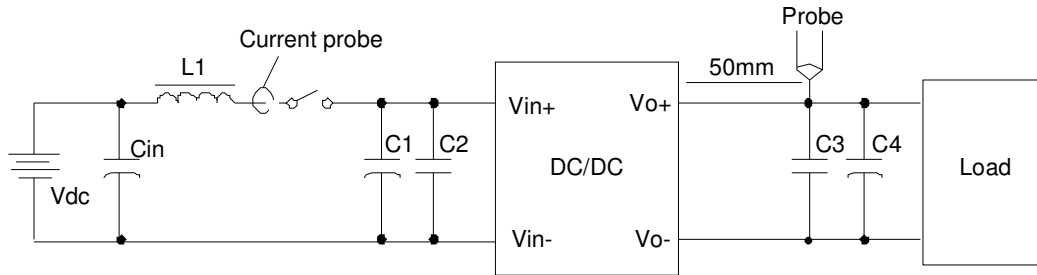

Figure 22 Input ripple & output ripple & noise test configuration

Vdc: DC power supply

L1: 12uH

Cin: 220uF/100V typical

C1 ~ C4: See Figure 17

Note - Using a coaxial cable with series 50ohm resistor and 0.68uF ceramic capacitor or a ground ring of probe to test output ripple & noise is recommended.

**Weight**

The AVO200-48S05-6L series weight is 31.5g.maximum.

## Soldering

### R5 Wave Soldering

The product is intended for standard manual or wave soldering.

When wave soldering is used, the temperature on pins is specified to maximum 255 °C for maximum 7s.

When soldering by hand, the iron temperature should be maintained at 300 °C ~ 380 °C and applied to the converter pins for less than 10s. Longer exposure can cause internal damage to the converter.

Cleaning of solder joint can be performed with cleaning solvent IPA or simulative.

### R5 Reflow/Wave Soldering

The product is intended for standard manual, reflow or wave soldering.

When reflow soldering is used, the temperature on pins is specified to maximum 230 °C for maximum 10s.

When wave soldering is used, the temperature on pins is specified to maximum 255 °C for maximum 7s.

When soldering by hand, the iron temperature should be maintained at 300 °C ~ 380 °C and applied to the converter pins for less than 10s. Longer exposure can cause internal damage to the converter.

Cleaning of solder joint can be performed with cleaning solvent IPA or simulative.

### √R6 Wave Soldering

The product is intended for standard manual, or wave soldering.

When wave soldering is used, the temperature on pins is specified to maximum 260 °C for maximum 7s.

When soldering by hand, the iron temperature should be maintained at 300 °C ~ 380 °C and applied to the converter pins for less than 10s. Longer exposure can cause internal damage to the converter.

Cleaning of solder joint can be performed with cleaning solvent IPA or simulative.

	Product requirement	Remark	Product Name
R6	Wave soldering	1.2V	AVO100-48S05B-6L

### √R6 Reflow/Wave Soldering

The product is intended for standard manual, reflow or wave soldering.

When reflow soldering is used, the temperature on pins is specified to maximum 260 °C for maximum 10s.

When wave soldering is used, the temperature on pins is specified to maximum 260 °C for maximum 7s.

When soldering by hand, the iron temperature should be maintained at 300 °C ~ 380 °C and applied to the converter pins for less than 10s. Longer exposure can cause internal damage to the converter.

Cleaning of solder joint can be performed with cleaning solvent IPA or simulative.

	Product requirement	Remark	Product Name
R6	Wave soldering	1.2V	AVO100-48S05-6L

## Hazardous Substances Announcement (RoHS of China)

Parts	Hazardous Substances					
	Pb	Hg	Cd	Cr <sup>6+</sup>	PBB	PBDE
AVO200-48S05	x	x	x	x	x	x
AVO200-48S05B	x	x	x	x	x	x

x: Means the content of the hazardous substances in all the average quality materials of the part is within the limits specified in SJ/T-11363-2006

√: Means the content of the hazardous substances in at least one of the average quality materials of the part is outside the limits specified in SJ/T11363-2006

Artesyn Embedded Technologies has been committed to the design and manufacturing of environment-friendly products. It will reduce and eventually eliminate the hazardous substances in the products through unremitting efforts in research. However, limited by the current technical level, the following parts still contain hazardous substances due to the lack of reliable substitute or mature solution:

1. Solders (including high-temperature solder in parts) contain plumbum.
2. Glass of electric parts contains plumbum.
3. Copper alloy of pins contains plumbum

### WORLDWIDE OFFICES

#### Americas

2900 S.Diablo Way  
Tempe, AZ 85282  
USA  
+1 888 412 7832

#### Europe (UK)

Waterfront Business Park  
Merry Hill, Dudley  
West Midlands, DY5 1LX  
United Kingdom  
+44 (0) 1384 842 211

#### Asia (HK)

14/F, Lu Plaza  
2 Wing Yip Street  
Kwun Tong, Kowloon  
Hong Kong  
+852 2176 3333



[www.artesyn.com](http://www.artesyn.com)

While every precaution has been taken to ensure accuracy and completeness in this literature, Artesyn Embedded Technologies assumes no responsibility, and disclaims all liability for damages resulting from use of this information or for any errors or omissions. Artesyn Embedded Technologies, Artesyn and the Artesyn Embedded Technologies logo are trademarks and service marks of Artesyn Technologies, Inc. All other names and logos referred to are trade names, trademarks, or registered trademarks of their respective owners.  
© 2014 All rights reserved.

For more information: [www.artesyn.com/power](http://www.artesyn.com/power)  
For support: [productsupport.ep@artesyn.com](mailto:productsupport.ep@artesyn.com)