

3 Watt

- Single Output
- Wide Range 2:1 Input
- SMD Package
- Industry Standard Pinout
- Regulated Output
- Operating Temperature -40 °C to +95 °C
- 1500 VDC Isolation, 3000 VDC Option
- 3 Year Warranty



Dimensions:

ISR:
0.94 x 0.765 x 0.31" (23.86 x 19.42 x 8.0 mm)

Models & Ratings

Input Voltage	Output Voltage	Output Current	Input Current		Maximum Capacitive Load	Efficiency	Model Number
			No Load	Full Load			
9-18	5V	600 mA	22 mA	333 mA	3300 µF	75%	ISR1205A
	12V	250 mA	22 mA	325 mA	1800 µF	77%	ISR1212A
	15V	200 mA	22 mA	316 mA	1000 µF	79%	ISR1215A
18-36	5V	600 mA	12 mA	164 mA	3300 µF	76%	ISR2405A
	12V	250 mA	12 mA	154 mA	1800 µF	81%	ISR2412A
	15V	200 mA	12 mA	156 mA	1000 µF	80%	ISR2415A
36-75	5V	600 mA	8 mA	81 mA	3300 µF	77%	ISR4805A
	12V	250 mA	8 mA	78 mA	1800 µF	80%	ISR4812A
	15V	200 mA	8 mA	78 mA	1000 µF	80%	ISR4815A

Notes

1. Input currents measured at nominal input voltage.

Mechanical Details

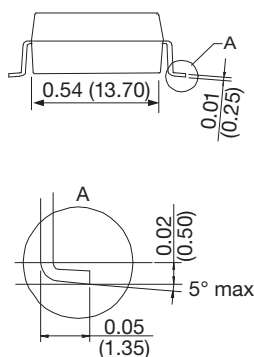
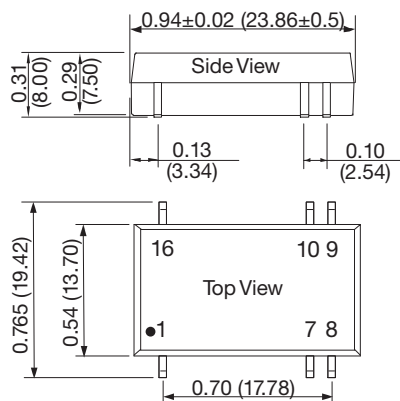

Recommended Footprint
Top View Grid: 0.1 x 0.1 in (2.54 x 2.54 mm)

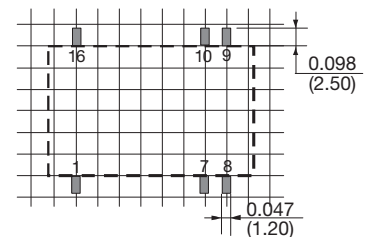

PIN CONNECTIONS	
Pin	Function
1	GND
7	No Connection
8	No Connection
9	+Vout
10	0V
16	+Vin

Notes

1. All dimensions are in inches (mm)
2. Weight: 0.0115 lbs (5.2 g) typical.

3. Pin pitch and length tolerance: ±0.014 (±0.35)
4. Case tolerance: ±0.02 (±0.5)

Input

Characteristic	Minimum	Typical	Maximum	Units	Notes & Conditions
Input Voltage Range	9		18	VDC	12 V nominal
	18		36	VDC	24 V nominal
	36		26.40	VDC	48 V nominal
Input Current					See Models and Ratings table
Input Reflected Ripple		15		mA pk-pk	Through 12 μ H inductor and 47 μ F capacitor
Input Surge			25	VDC for 1 s	12 V models
			50	VDC for 1 s	24 V models
			100	VDC for 1 s	24 V models
Input Filter	Pi filter				

Output

Characteristic	Minimum	Typical	Maximum	Units	Notes & Conditions
Output Voltage	5		15	VDC	See Models and Ratings table
Initial Set Accuracy		± 1	± 3	%	At 100% load
Minimum Load	5			%	
Line Regulation			± 0.4	%	
Load Regulation			± 0.75	%	10% to full load
Start Up Delay		2		ms	
Ripple and Noise			60	mV pk-pk	20 MHz bandwidth, measured using 0.1 μ F capacitor
Transient Response			5	% deviation	Recovery to within 1% in 5 ms for a 25% load change
Short Circuit Protection					Continuous, with auto recovery
Maximum Capacitive Load					See Models and Ratings table
Temperature Coefficient			0.03	%/ $^{\circ}$ C	

General

Characteristic	Minimum	Typical	Maximum	Units	Notes & Conditions
Efficiency					See Models and Ratings table
Isolation: Input to Output	1500			VDC	
Switching Frequency		350		kHz	100% load and nominal input voltage
Isolation Resistance	10^9			Ω	Input to output, tested at 500 VDC
Isolation Capacitance		1		nF	Input to output
Power Density			13.4	Win ³	
Mean Time Between Failure	1000			kHrs	MIL-HDBK-217F, +25 $^{\circ}$ C GB
Weight		0.0115 (5.2)		lb (g)	

Environmental

Characteristic	Minimum	Typical	Maximum	Units	Notes & Conditions
Operating Temperature	-40		+95	$^{\circ}$ C	Derate linearly from 100% load at +85 $^{\circ}$ C to 50% load at 95 $^{\circ}$ C
Storage Temperature	-55		+125	$^{\circ}$ C	
Case Temperature			+105	$^{\circ}$ C	
Operating Humidity			95	% RH	Non-condensing
Cooling					Natural convection

EMC: Emissions

Phenomenon	Standard	Test Level	Notes & Conditions
Conducted	EN55022	Class B	See Application Note for Class B filter
Radiated	EN55022	Class B	See Application Note for Class B filter

EMC: Immunity

Phenomenon	Standard	Test Level	Criteria	Notes & Conditions
ESD Immunity	EN61000-4-2	±4 kV	B	Contact
Radiated Immunity	EN61000-4-3	10 V/m	A	
EFT/Burst	EN61000-4-4	2	B	External input filter required, see application note
Surge	EN61000-4-5	2	B	External input filter required, see application note
Conducted Immunity	EN61000-4-6	3 V rms	A	
Magnetic Fields	EN61000-4-8	1 A/m	A	

Mechanical Details

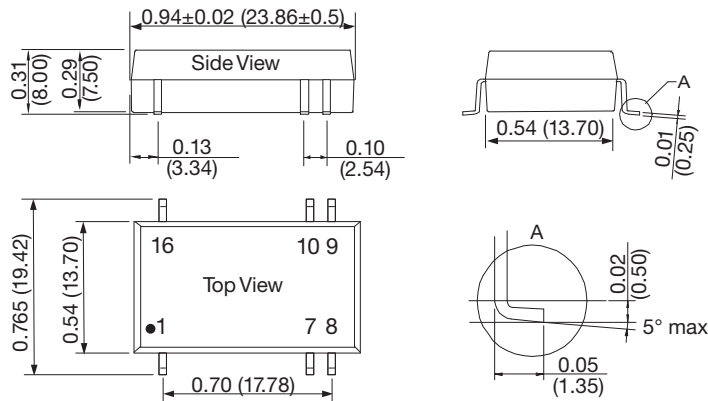

Recommended Footprint
Top View Grid: 0.1 x 0.1 in (2.54 x 2.54 mm)

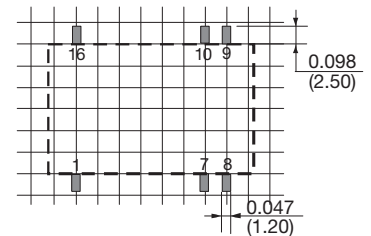

PIN CONNECTIONS	
Pin	Function
1	GND
7	No Connection
8	No Connection
9	+Vout
10	0 V
16	+Vin

Notes

- All dimensions are in inches (mm)
- Weight: 0.0115 lbs (5.2 g) typical.
- Pin pitch and length tolerance: ±0.014 (±0.35)
- Case tolerance: ±0.02 (±0.5)

Application Note

EMI Filter for Class B Emissions

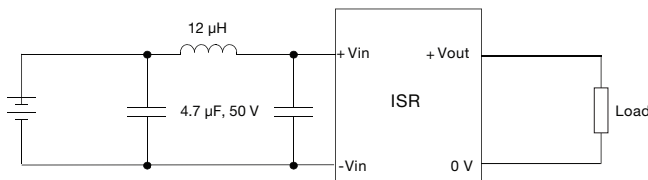

Filter for Immunity

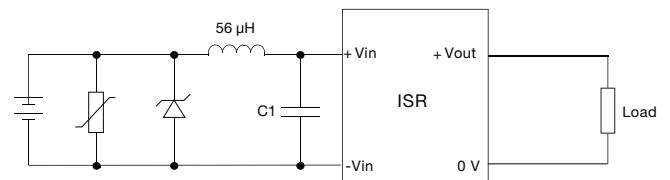

Input Voltage	MOV	TVS	C1
12 V	-	SMCJ28A	680 µF/25 V
24 V	10D560	SMCJ48A	120 µF/50 V
48 V	10D101	SMCJ90A	120 µF/100 V