

Features

- Floating channel designed for bootstrap operation
- Fully operational to +600 V
- Tolerant to negative transient voltage – dV/dt immune
- Gate drive supply range from 10 V to 20 V
- Undervoltage lockout
- CMOS Schmitt-triggered inputs with pull-down (AUIRS2123)
- CMOS Schmitt-triggered inputs with pull-up (AUIRS2124)
- Output in phase with input (AUIRS2123) or out of Phase with input (AUIRS2124)
- RESET- input is 3.3V and 5V logic compatible (AUIRS2123S only)
- Leadfree, RoHS compliant
- Automotive qualified*

Typical Applications

- General purpose single high side inverters

Product Summary

Topology	Single highside
V_{OFFSET}	$\leq 600 \text{ V}$
V_{OUT}	10 V – 20 V
$I_{\text{O+}} \& I_{\text{O-}}$ (typical)	500 mA
$t_{\text{ON}} \& t_{\text{OFF}}$ (typical)	140 ns & 140 ns

Package Options

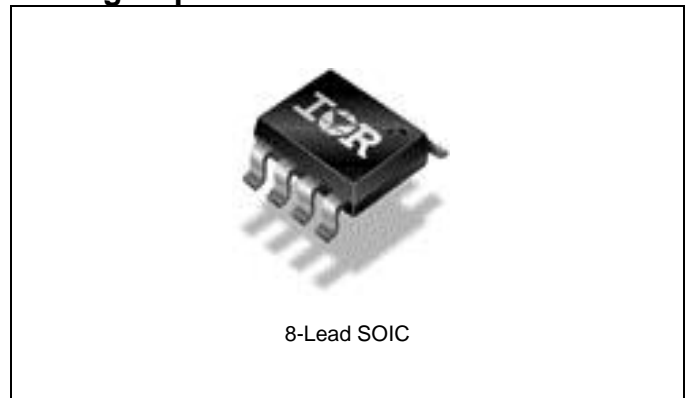

Typical Connection Diagram

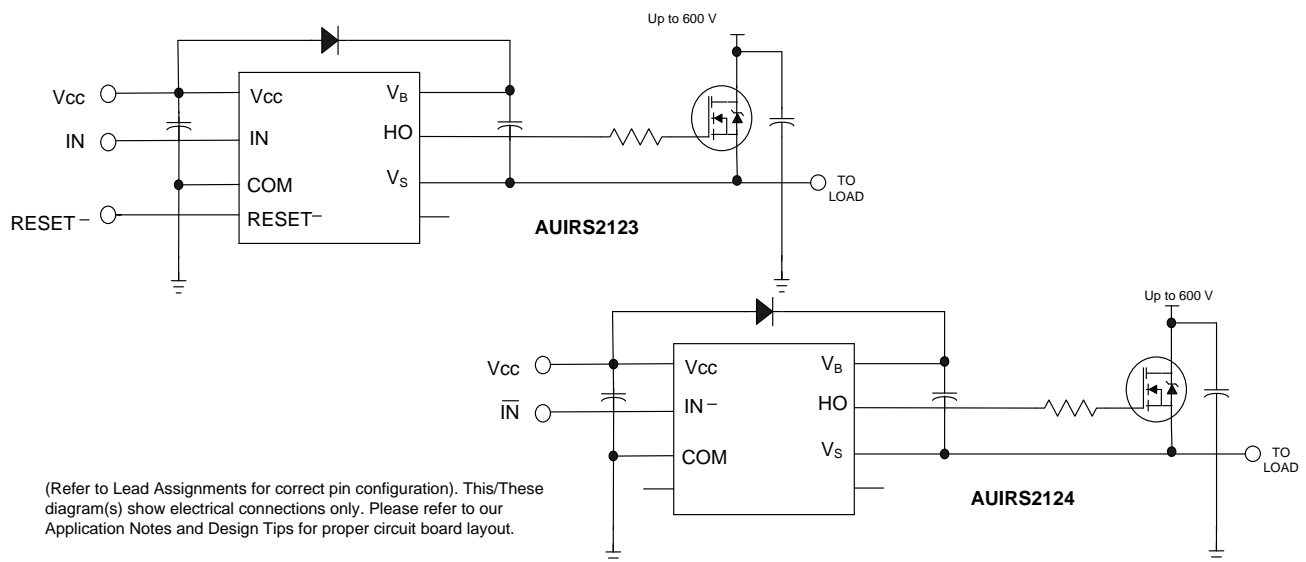

Table of Contents	Page
Description	3
Qualification Information	4
Absolute Maximum Ratings	5
Recommended Operating Conditions	5
Static Electrical Characteristics	6
Dynamic Electrical Characteristics	6
Functional Block Diagram	7
Input/Output Pin Equivalent Circuit Diagram	8
Lead Definitions	9
Lead Assignments	9
Application Information and Additional Details	10
Parameter Temperature Trends	11
Package Details	15
Tape and Reel Details	16
Part Marking Information	17
Ordering Information	18

Description

The AUIRS2123S/AUIRS2124S are high voltage, high speed power MOSFET and IGBT drivers. Proprietary HVIC and latch immune CMOS technologies enable ruggedized monolithic construction. The RESET- input is compatible with standard CMOS outputs (AUIRS2123S only). The output drivers feature a high pulse current buffer stage designed for minimum cross-conduction. The floating channel can be used to drive an N-channel power MOSFET or IGBT in the high-side configuration which operates up to 600 V.

Qualification Information[†]

Qualification Level		Automotive (per AEC-Q100)	
		Comments: This family of ICs has passed an Automotive qualification. IR's Industrial and Consumer qualification level is granted by extension of the higher Automotive level.	
Moisture Sensitivity Level		SOIC8	MSL3 ^{††} 260°C (per IPC/JEDEC J-STD-020)
ESD	Machine Model	Class M3 (per AEC-Q100-003)	
	Human Body Model	Class H2 (per AEC-Q100-002)	
	Charged Device Model	Class C5 (per AEC-Q100-011)	
IC Latch-Up Test		Class II, Level A (per AEC-Q100-004)	
RoHS Compliant		Yes	

[†] Qualification standards can be found at International Rectifier's web site <http://www.irf.com/>

^{††} Higher MSL ratings may be available for the specific package types listed here. Please contact your International Rectifier sales representative for further information.

Absolute Maximum Ratings

Absolute Maximum Ratings indicate sustained limits beyond which damage to the device may occur. All voltage parameters are absolute voltages referenced to GND, all currents are defined positive into any lead. This is a stress only rating and operation of the device at these or any conditions exceeding those indicated in the operational sections of this specification is not implied

Symbol	Definition	Min.	Max.	Units
V_{BS}	High Side Floating Supply Voltage	-0.3	25	V
V_B	High Side Driver Output Stage Voltage	-0.3	625	V
V_S	High Side Floating Supply Offset Voltage	$V_B - 25$	$V_B + 0.3$	V
V_{Ho}	Output Voltage Gate Connection	$V_S - 0.3$	$V_B + 0.3$	V
V_{CC}	Supply Voltage	-0.3	25	V
V_{IN}	Input Voltage	-0.3	$V_{CC} + 0.3$	V
V_{RES}	Reset Input Voltage	-0.3	$V_{CC} + 0.3$	V
dV/dt	Allowable Offset Voltage Slew Rate	-50	50	V/nsec
T_J	Junction Temperature	-55	150	°C
T_S	Storage Temperature	-55	150	

Recommended Operating Conditions

For proper operations the device should be used within the recommended conditions.

Symbol	Definition	Min.	Max.	Units
V_B	High Side Driver Output Stage Voltage -10V Transient 0.4 μ s	$V_S + 10$	$V_S + 20$	V
V_S	High Side Floating Supply Offset Voltage -25V Transient 0.4 μ s	†	600	V
V_{Ho}	Output Voltage Gate Connection	V_S	V_B	V
V_{CC}	Supply Voltage	10	20	V
V_{IN}	Input Voltage	0	V_{CC}	V
V_{RES}	Reset Input Voltage	0	V_{CC}	V
T_A	Ambient Temperature ($f_s < 60$ kHz, $V_{BS} = 14$ V, $C_{load} = 2.5$ nF, $R = 50$ Ohm)	-40	125	°C

† Logic operational for V_S of -5 to +600 V. Logic state held for V_S of -5 V to $-V_{BS}$.
(Please refer to the Design Tip DT97-3 for more details).

Static Electrical Characteristics

V_{BIAS} (V_{CC} , V_{BS}) = 15 V and T_A = 25°C unless otherwise specified. The V_{IL} , V_{IH} and I_{IN} parameters are referenced to COM. The V_O and I_O parameters are referenced to COM and are applicable to the respective output leads: HO and LO.

Symbol	Definition	Min	Typ	Max	Units	Test Conditions	
V_{IHIN}	IN Logic "1" input voltage	AUIRS2123	0.70	—	—	V	
	IN Logic "0" input voltage	AUIRS2124	* V_{CC}	—	—		
V_{ILIN}	IN Logic "0" input voltage	AUIRS2123	—	—	0.35		
	IN Logic "1" input voltage	AUIRS2124	—	—	* V_{CC}		
V_{IHRST}	RESET- Logic "1" input voltage	AUIRS2123	—	—	1.5		
V_{ILRST}	RESET- Logic "0" input voltage	AUIRS2123	2.9	—	—		
V_{OH}	High level output voltage, $V_{BIAS} - V_O$	—	—	2	$I_O = 10$ mA		
V_{OL}	Low level output voltage, V_O	—	0.1	0.2			
I_{LK}	Offset supply leakage current	—	—	50	μ A		$V_B = V_S = 600$ V
I_{QBS}	Quiescent V_{BS} supply current	—	—	240			$V_{IN} = 0$ V or V_{CC}
I_{QCC}	Quiescent V_{CC} supply current	—	—	500		$V_{reset} = 5$ V	
I_{IN+}	$V_{IN} = 5$ V Pull Down Input Current	AUIRS2123	—	125		—	$V_{IN} = 5$ V
	$V_{IN} = 0$ V IN Pull Up Input Current	AUIRS2124					$V_{IN} = 0$ V
I_{IN-}	$V_{IN} = 0$ V IN Pull Down Input Current	AUIRS2123	—	—		5.0	$V_{IN} = 15$ V
	$V_{IN} = 15$ V Pull Up Input Current	AUIRS2124					
I_{RES-}	$V_{RESET} = 5$ V Pull Down Input Current	AUIRS2123	—	125		—	$V_{RESET} = 5$ V
I_{RES+}	$V_{RESET} = 0$ V Pull Down Input Current	AUIRS2123	—	—		5.0	$V_{RESET} = 0$ V
V_{BSUV+}	V_{BS} supply undervoltage positive going threshold	7.2					
V_{BSUV-}	V_{BS} supply undervoltage negative going threshold	6.6	8.0	9.0			
V_{CCUV+}	V_{CC} supply undervoltage positive going threshold	7.2	8.6	9.6			
V_{CCUV-}	V_{CC} supply undervoltage negative going threshold	6.6	8.0	9.0			
I_{O+}	Output high short circuit pulsed current (†)	250	500	—	mA	$V_O = 0$ V, $V_{IN} =$ Logic "1" $PW \leq 10$ μ s	
I_{O-}	Output low short circuit pulsed current(†)	250	500	—		$V_O = 15$ V, $V_{IN} =$ Logic "0" $PW \leq 10$ μ s	

(†) : guaranteed by design.

Dynamic Electrical Characteristics

V_{BIAS} (V_{CC} , V_{BS}) = 15 V, C_L = 1000 pF, T_A = 25°C unless otherwise specified. The dynamic electrical characteristics are measured using the test circuit shown in Fig. 3.

Symbol	Definition	Min	Typ	Max	Units	Test Conditions
t_{on}	Turn-on propagation delay	—	140	240	ns	$V_S = 0$ V and $V_S = 600$ V
t_{off}	Turn-off propagation delay	—	140	240		
t_r	Turn-on rise time	—	80	200		
t_f	Turn-off fall time	—	80	200		
t_{RES}	RESET to output turn off propagation delay (AUIRS2123 only)	—	170	300		

Functional Block Diagram (AUIRS2123)

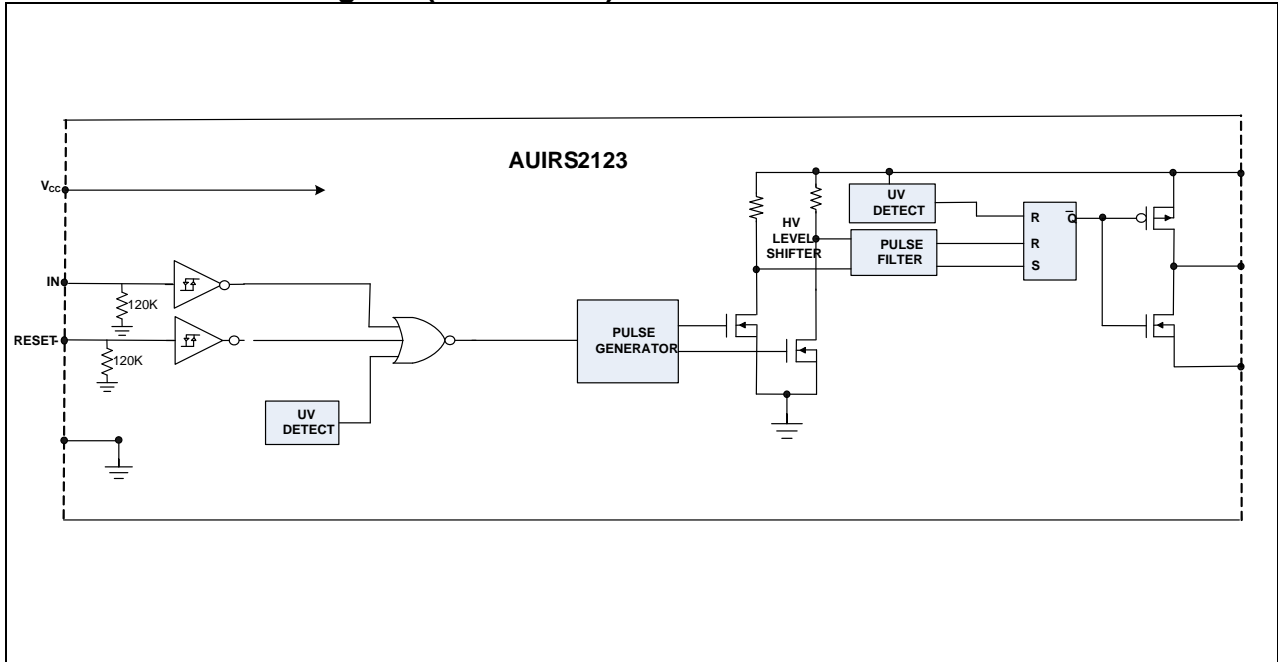

Functional Block Diagram (AUIRS2124)

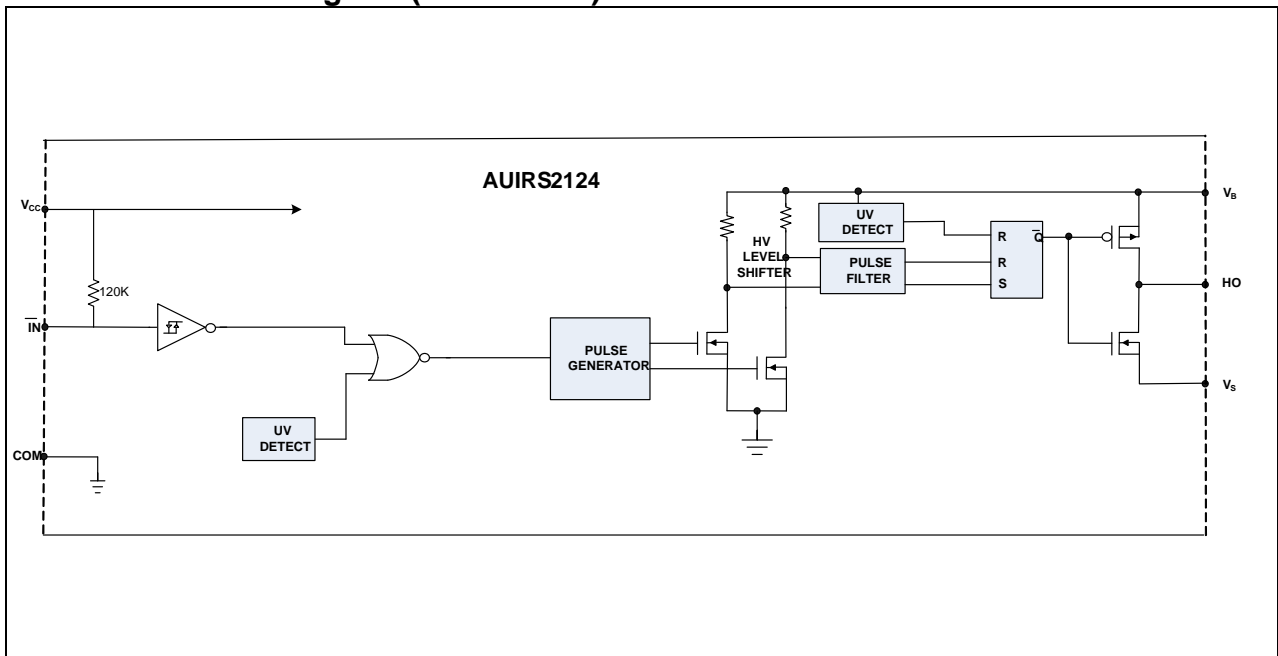

I/O Pin Equivalent Circuit Diagram

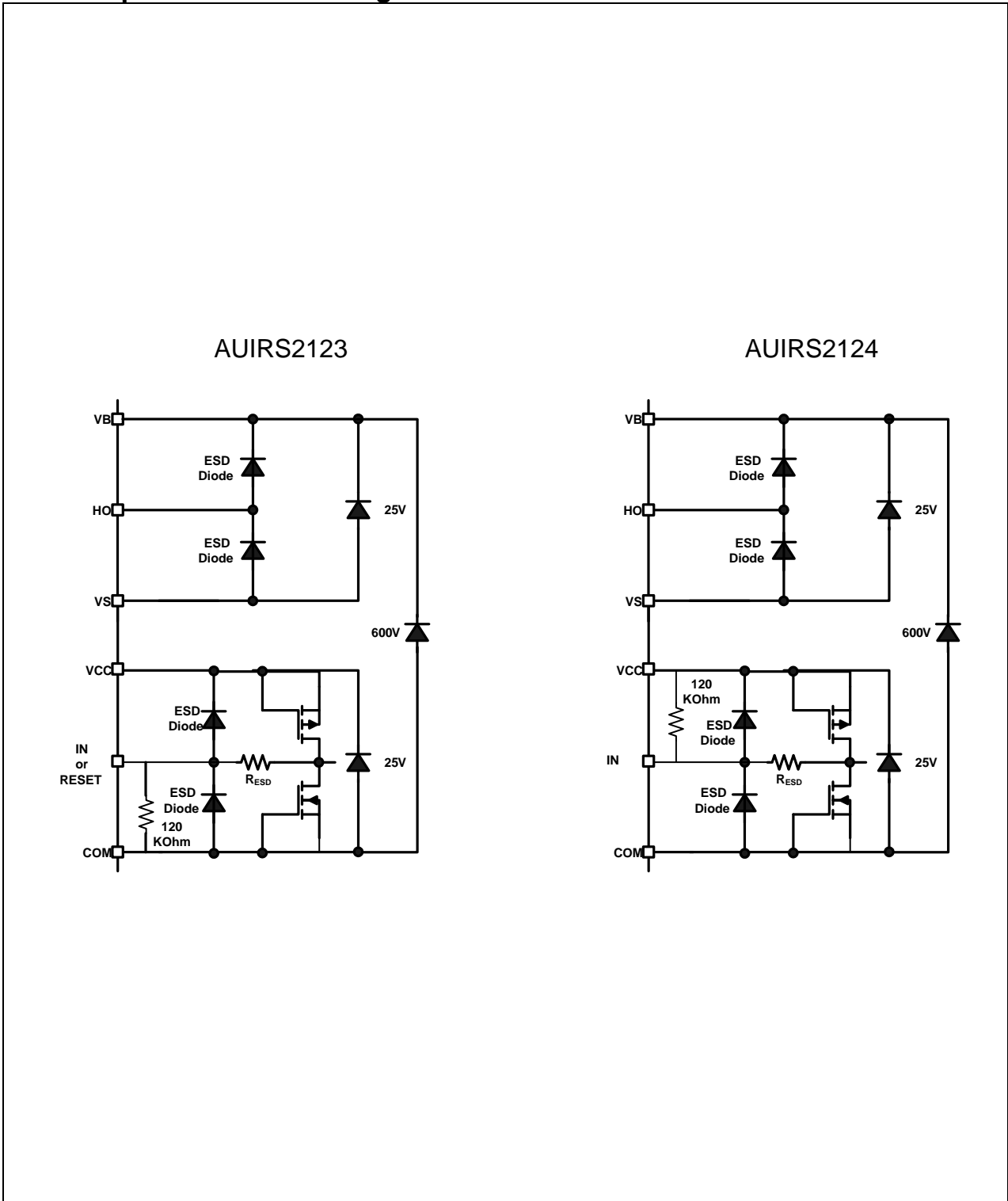

Lead Definitions

Pin	Symbol	Pin description
1	V _{CC}	Low side and logic fixed supply
2	IN IN-	Logic input for gate driver output (HO), in phase with HO (AUIRS2123) Logic input for gate driver output (HO), out of phase with HO (AUIRS2124)
3	COM	Logic Ground
4	RESET- NC	Driver Enable Signal Input (negative logic) (AUIRS2123) No connection (AUIRS2124)
5	NC	No connection
6	V _S	High-side floating supply return
7	H _O	High-side gate drive output
8	V _B	High-side floating supply

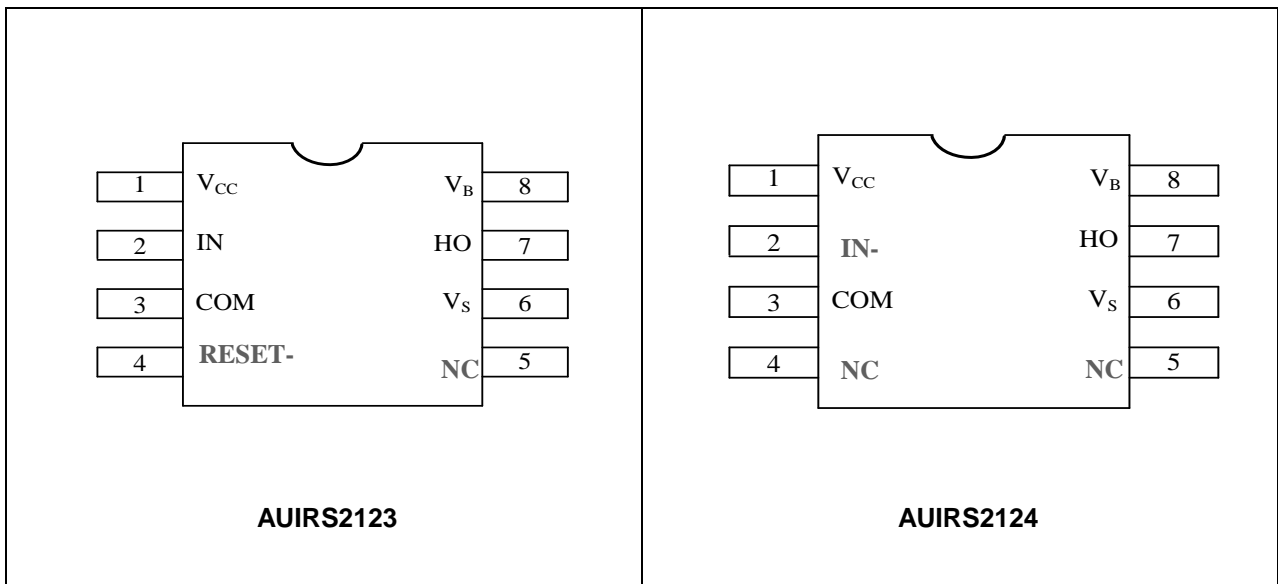

Application Information and Additional Details

 AUIRS2123 logic table for V_{CC} , V_{BS} , RESET, IN, and H_o

V_{CC}	V_{BS}	RESET-	IN	H_o
X	X	X	LOW	OFF
X	X	LOW	X	OFF
< $V_{CCUVLO-}$	X	X	X	OFF
X	< $V_{BSUVLO-}$	X	X	OFF
> $V_{CCUVLO+}$	> $V_{BSUVLO+}$	HIGH	HIGH	ON

RESET = HIGH indicates that high side NMOS is allowed to be turned on.

RESET = LOW indicates that high side NMOS is OFF.

IN = HIGH indicates that high side NMOS is on.

IN = LOW indicates that high side NMOS is off.

X = independent

 AUIRS2124 logic table for V_{CC} , V_{BS} , RESET, IN, and H_o

V_{CC}	V_{BS}	IN-	H_o
X	X	HIGH	OFF
< $V_{CCUVLO-}$	X	X	OFF
X	< $V_{BSUVLO-}$	X	OFF
> $V_{CCUVLO+}$	> $V_{BSUVLO+}$	LOW	ON

IN- = HIGH indicates that high side NMOS is on.

IN- = LOW indicates that high side NMOS is off.

X = independent

Parameter Temperature Trends

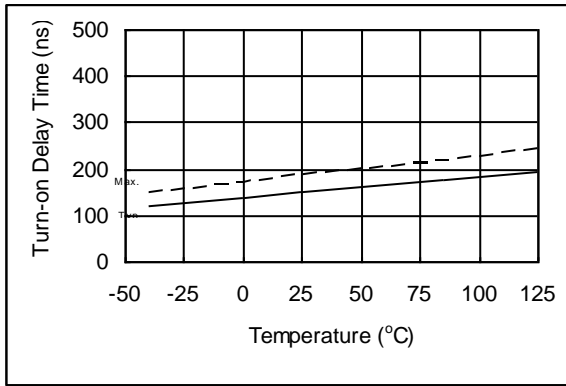

Figure 1A. Turn-on Delay Time vs. Temperature

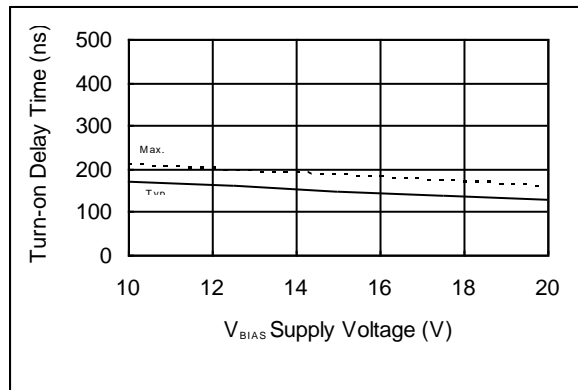

Figure 1B. Turn-on Delay Time vs. Supply Voltage

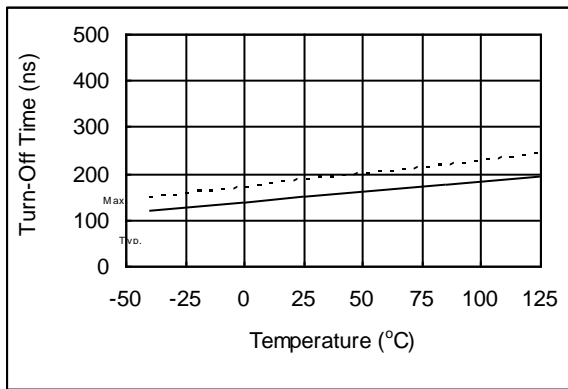

Figure 2A. Turn-Off Time vs. Temperature

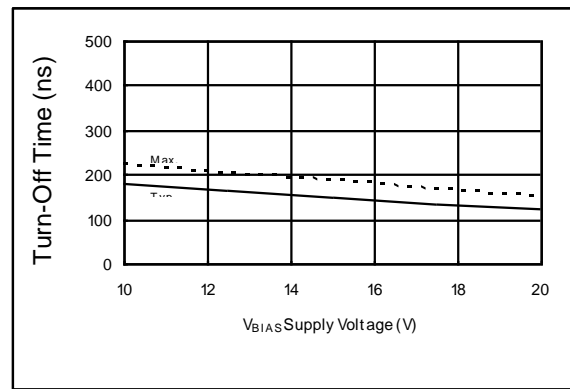

Figure 2B. Turn-Off Time vs. Supply Voltage

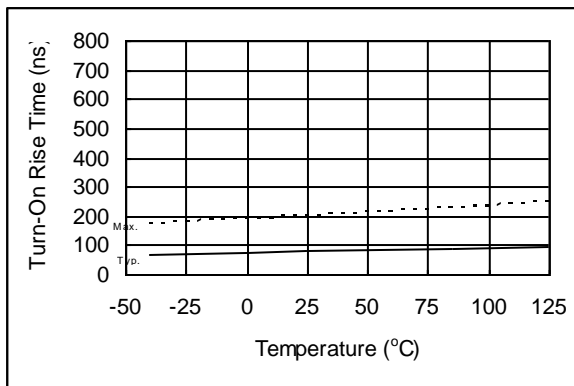

Figure 3A. Turn-On Rise Time (VBS=17V) vs. Temperature

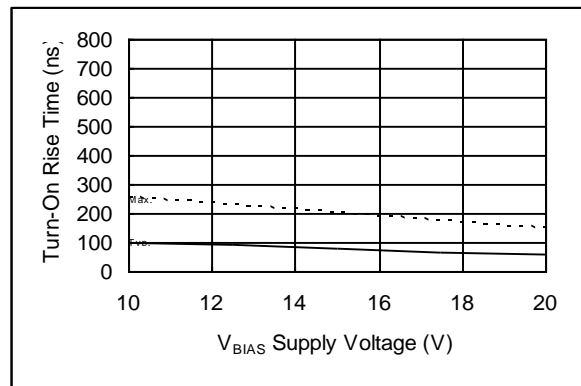

Figure 3B. Turn-On Rise Time (VBS=17V) vs. Supply Voltage

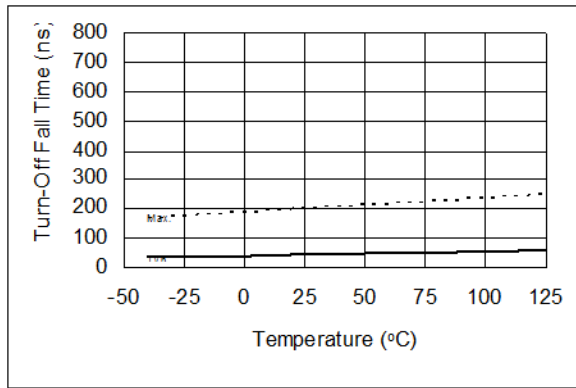

Figure 4A. Turn-Off Fall Time (VBS=17V) vs. Temperature

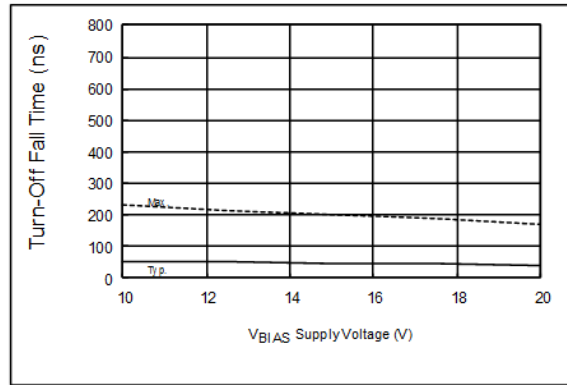

Figure 4B. Turn-Off Fall Time (VBS=17) vs. Supply Voltage

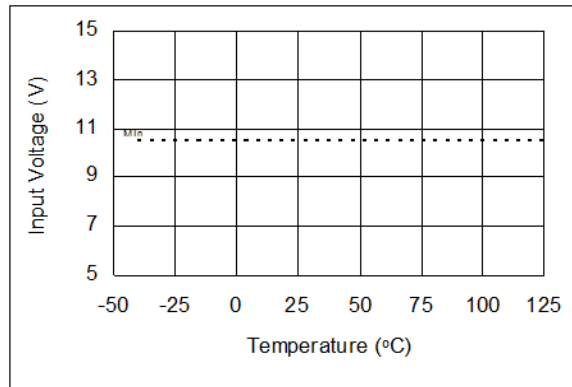

Figure 5A. Logic "1" Input Voltage vs. Temperature

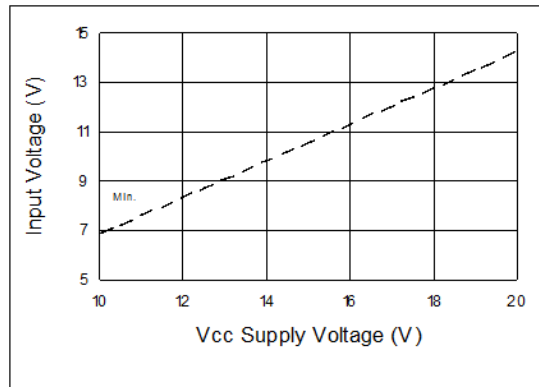

Figure 5B. Logic "1" Input Voltage vs. Supply Voltage

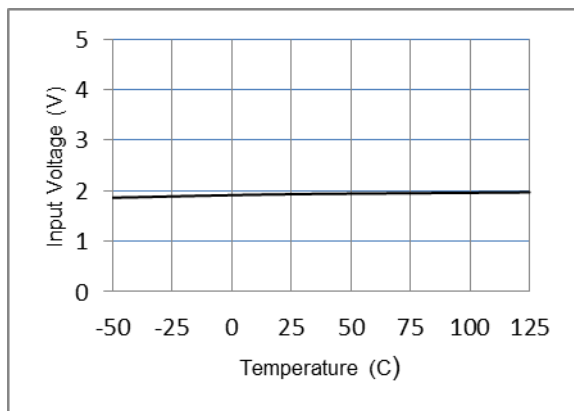

Figure 5C. Logic "1" Input Voltage (RESET pin) versus Temperature

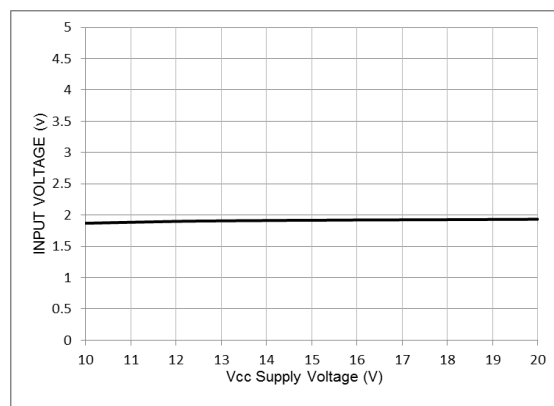

Figure 5D. Logic "1" Input Voltage (RESET pin) versus Supply Voltage

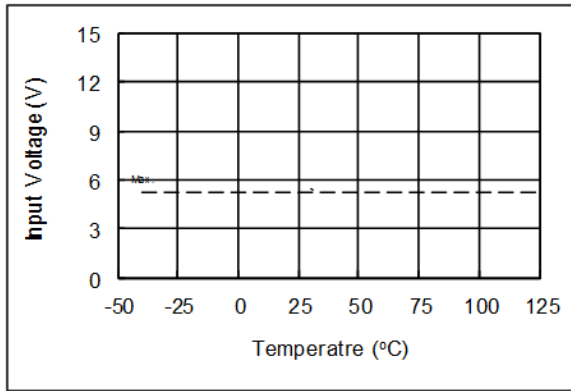

Figure 6A. Logic "0" Input Voltage vs. Temperature

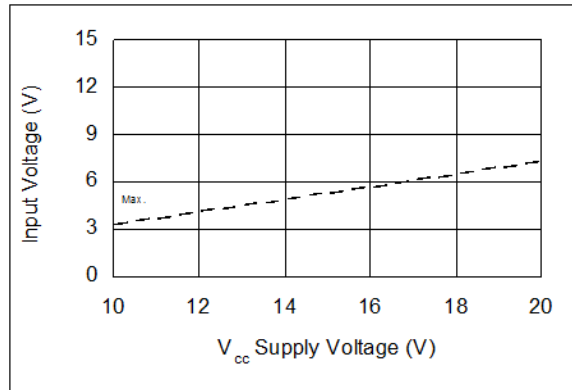

Figure 6B. Logic "0" Input Voltage vs. Supply Voltage

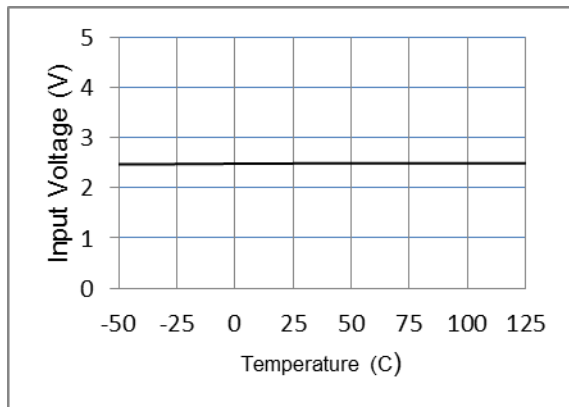

Figure 6C. Logic "0" Input Voltage (RESET pin) versus Temperature

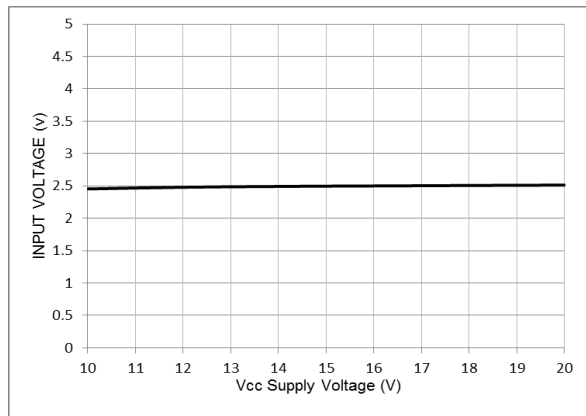

Figure 6D. Logic "0" Input Voltage (RESET pin) versus Supply Voltage

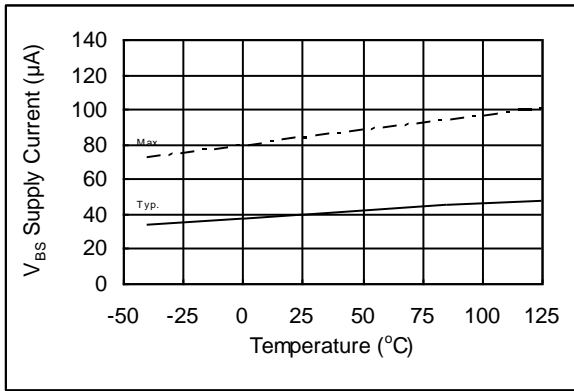

Figure 7A. VBS Supply Current vs. Temperature

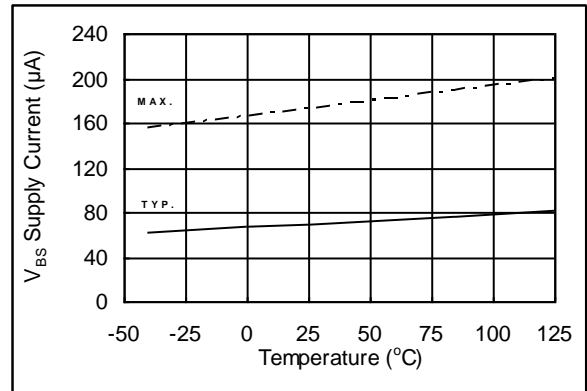

Figure 8A. VBS Supply Current vs. Temperature

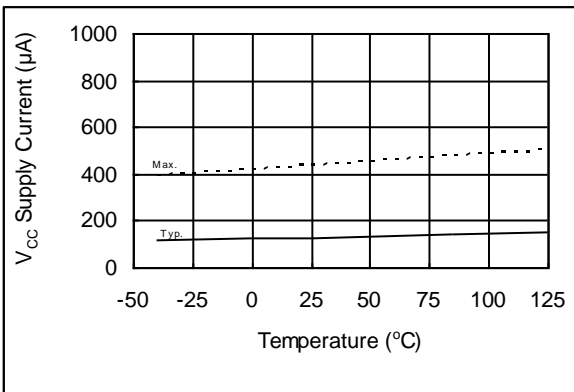

Figure 9A. Vcc Supply Current vs. Temperature

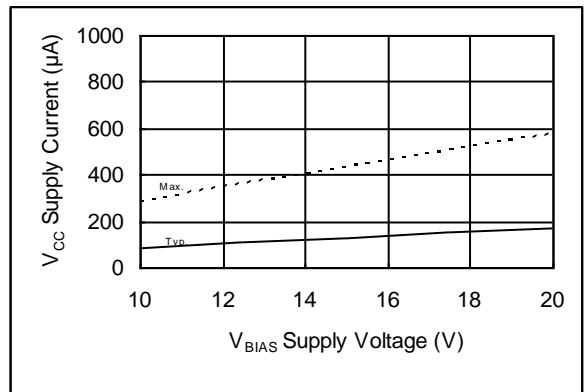

Figure 9B. Vcc Supply Current vs. Supply Voltage

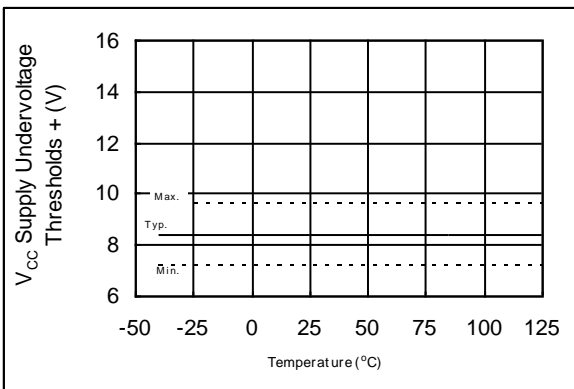

Figure 10A. Vcc Supply Undervoltage Threshold (+) vs. Temperature

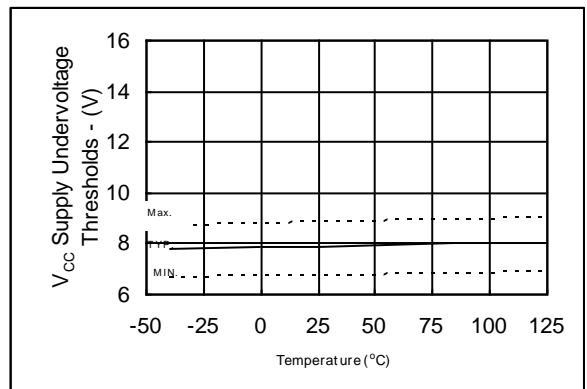

Figure 10B. Vcc Supply Undervoltage Threshold (-) vs. Temperature

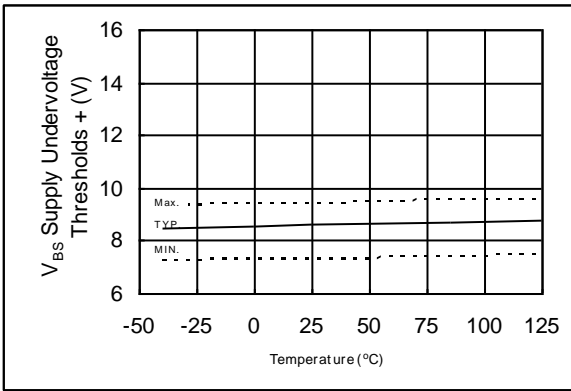

Figure 11A. VBS Supply Undervoltage Threshold (+) vs. Temperature

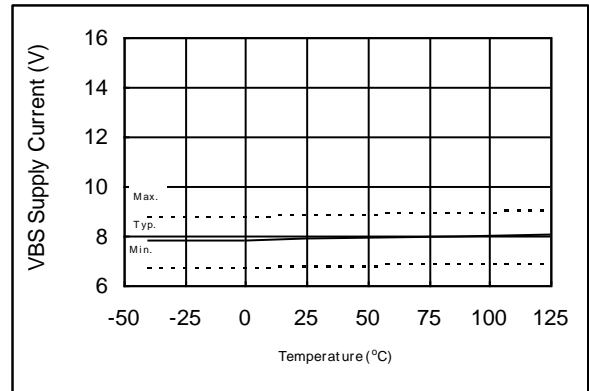

Figure 11B. VBS Supply Undervoltage Threshold (-) vs. Temperature

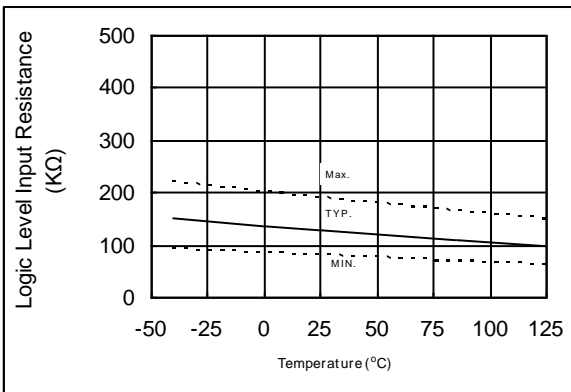

Figure 12. Logic Level Input Resistance vs. Temperature

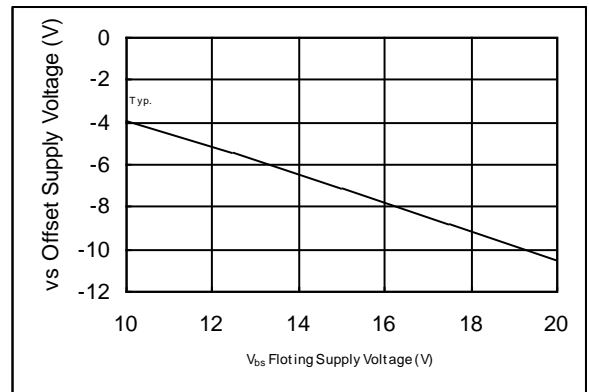

Figure 13. Maximum VS Negative Offset vs. Supply Voltage

Package Details

RECOMMENDED FOOTPRINT

DIM	INCHES		MILLIMETERS	
	MIN	MAX	MIN	MAX
A	.0532	.0688	1.35	1.75
A1	.0040	.0098	0.10	0.25
B	.014	.018	0.36	0.46
C	.0075	.0098	0.19	0.25
D	.189	.196	4.80	4.98
E	.150	.157	3.81	3.99
e	.050	BASIC	1.27	BASIC
e1	.025	BASIC	0.635	BASIC
H	.2284	.2440	5.80	6.20
K	.011	.019	0.28	0.48
L	.016	.050	0.41	1.27
y	0°	8°	0°	8°

NOTES:

- DIMENSIONING & TOLERANCING PER ANSI Y14.5M-1982.
- CONTROLLING DIMENSION: MILLIMETER.
- DIMENSIONS ARE SHOWN IN MILLIMETERS [INCHES].
- OUTLINE CONFORMS TO JEDEC OUTLINE MS-012AA.
- DIMENSION DOES NOT INCLUDE MOLD PROTRUSIONS. MOLD PROTRUSIONS NOT TO EXCEED 0.25 [.006].
- DIMENSION IS THE LENGTH OF LEAD FOR SOLDERING TO A SUBSTRATE.

8 Lead SOIC

Tape and Reel Details

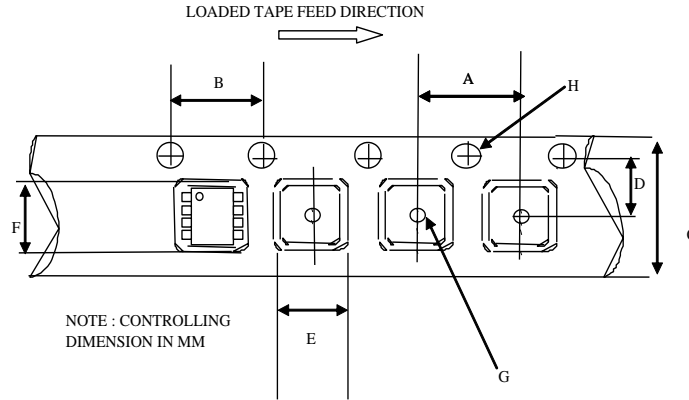

CARRIER TAPE DIMENSION FOR 8SOICN

Code	Metric		Imperial	
	Min	Max	Min	Max
A	7.90	8.10	0.311	0.318
B	3.90	4.10	0.153	0.161
C	11.70	12.30	0.46	0.484
D	5.45	5.55	0.214	0.218
E	6.30	6.50	0.248	0.255
F	5.10	5.30	0.200	0.208
G	1.50	n/a	0.059	n/a
H	1.50	1.60	0.059	0.062

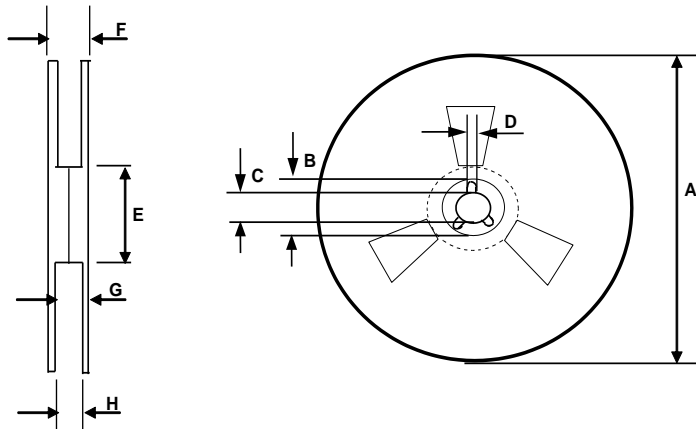

REEL DIMENSIONS FOR 8SOICN

Code	Metric		Imperial	
	Min	Max	Min	Max
A	329.60	330.25	12.976	13.001
B	20.95	21.45	0.824	0.844
C	12.80	13.20	0.503	0.519
D	1.95	2.45	0.767	0.096
E	98.00	102.00	3.858	4.015
F	n/a	18.40	n/a	0.724
G	14.50	17.10	0.570	0.673
H	12.40	14.40	0.488	0.566

Part Marking Information

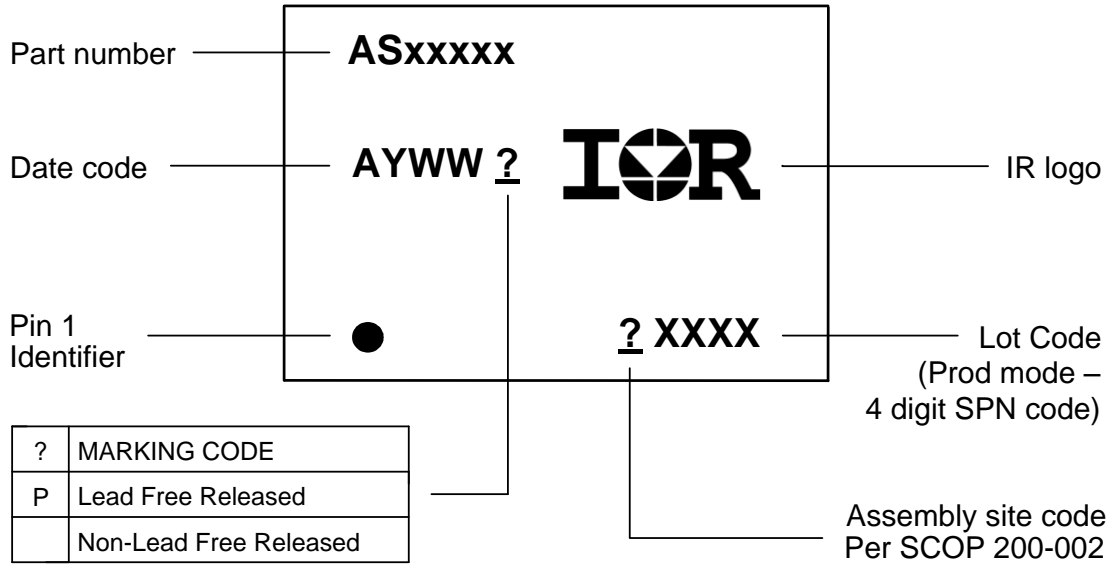

Ordering Information

Base Part Number	Package Type	Standard Pack		Complete Part Number
		Form	Quantity	
AUIRS2123S	SOIC8	Tube/Bulk	95	AUIRS2123S
		Tape and Reel	2500	AUIRS2123STR
AUIRS2124S	SOIC8	Tube/Bulk	95	AUIRS2124S
		Tape and Reel	2500	AUIRS2124STR

The information provided in this document is believed to be accurate and reliable. However, International Rectifier assumes no responsibility for the consequences of the use of this information. International Rectifier assumes no responsibility for any infringement of patents or of other rights of third parties which may result from the use of this information. No license is granted by implication or otherwise under any patent or patent rights of International Rectifier. The specifications mentioned in this document are subject to change without notice. This document supersedes and replaces all information previously supplied.

For technical support, please contact IR's Technical Assistance Center

<http://www.irf.com/technical-info/>

WORLD HEADQUARTERS:

101 N. Sepulveda Blvd., El Segundo, California 90245
Tel: (310) 252-7105

Revision History

Date	Comment									
MM/DD/YY	Original document									
07/17/08	Created AUIRS2123/2124 datasheet based on IRS2123/2124 datasheet.									
08/05/08	Added "Automotive Grade" on the first page. Modified the qual table on Page 4									
08/21/08	Removed "preliminary" and below section from Absolute Maximum Rating table for on line posting (please see Aug 5 datasheet for original location)									
	<table border="1"> <tr> <td>V_{esd}</td> <td>Electrostatic Discharge Voltage (Human body model)</td> <td>2k</td> <td></td> <td>✓</td> </tr> <tr> <td>V_{CMD}</td> <td>Charge Device Model CDM, EOS/ESD Ass. Std 5.3. Number of discharges per pin: 6</td> <td>2K</td> <td></td> <td>✓</td> </tr> </table>	V_{esd}	Electrostatic Discharge Voltage (Human body model)	2k		✓	V_{CMD}	Charge Device Model CDM, EOS/ESD Ass. Std 5.3. Number of discharges per pin: 6	2K	
V_{esd}	Electrostatic Discharge Voltage (Human body model)	2k		✓						
V_{CMD}	Charge Device Model CDM, EOS/ESD Ass. Std 5.3. Number of discharges per pin: 6	2K		✓						
08/22/08	Changed the description of the part from MOS CR High Side Driver IC (NON INVERTING) to High Side DRIVER IC.									
03/02/09	Fixed the error for order information Updated the Qual table									
10/25/10	Front Page Features pull up and pull down sentences corrected; $I_{IN+}, I_{IN-}, I_{RES+}, I_{RES-}$ lines updated in Static Electrical Char. Functional Block Diagrams pull up and pull down Updated I/O Pin Equivalent Circuit Diagram Updated									
04/02/14	Added $V_{ih,max}$ and $V_{il,min}$ for Reset pin in the Static Electrical characteristics. Also added $V_{ih,typ}$ and $V_{il,typ}$ figures vs T_j and V_{cc} . Also, added RESET- characteristics to Features and Description paragraphs.									
04-11-14	Changed I_{in-} conditions for AUIRS2124; changed conditions for t_{on}/t_{off}									
04-18-14	Page 6 added "guaranteed by design" note for I_{o+} and I_{o-} Remove Note †† on page 4 Update contact page 19									