

Low-cost, Compact Photoelectric Sensor

<READ AND UNDERSTAND THIS CATALOG>

Please read and understand this catalog before purchasing the products. Please consult your OMRON representative if you have any questions or comments.

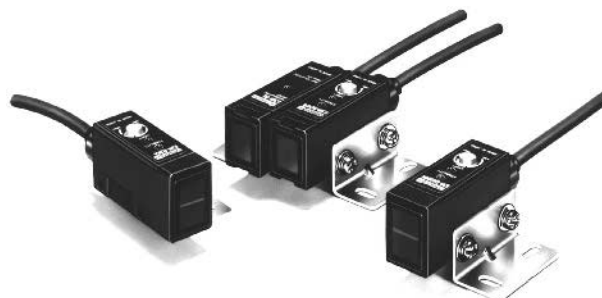

Ordering Information

E3R

Sensing method	Sensing distance	Operating mode	Model
Through-beam	5 m	Light-ON, Dark-ON (selectable)	E3R-5E4
Retroreflective	0.1 to 2 m		E3R-R2E4
Diffuse reflective	30 cm		E3R-DS30E4

Note: The through-beam model consists of the E3R-5L Emitter and E3R-5DE4 Receiver.

E3R-5E4 with Slit

Slit width	Sensing distance	Model
1 mm	1 m (see note)	E39-S5
2 mm	1.5 m (see note)	

Note: The above sensing distances are possible with a Slit attached to both the Emitter and the Receiver. Refer to *Engineering Data* for details.

Accessories (Order Separately)

Name	Model
Retroreflector	E39-R1

Specifications

Item	E3R-5E4	E3R-R2E4	E3R-DS30E4
LED for Emitter	Infrared LED		
Indicator	Light indicator (red) Stability indicator (green) The emitter incorporates a power indicator.	Light indicator (red) Stability indicator (green)	
Sensitivity adjustment	One-turn adjuster		
Connection method	Cord pre-wired type		
Materials	Case: Polybutylene terephthalate Lens: Polycarbonate		

■ Ratings/Characteristics

Item	Through-beam	Retroreflective	Diffuse reflective
	E3R-5E4	E3R-R2E4	E3R-DS30E4
Power supply voltage	12 to 24 VDC $\pm 10\%$; ripple (p-p): 10% max.		
Current consumption	50 mA max.	40 mA max.	
Sensing distance	5 m	0.1 to 2 m	30 cm (20 x 20 cm white mat paper)
Sensing object	Opaque object: 10 mm min.	Opaque object: 30 mm min.	Transparent, opaque objects
Directional angle	3° to 10°	Emitter, Receiver: 3° to 10° Retroreflector: 30° min.	---
Differential travel	---		20% max. of rated sensing distance
Response time	3 ms max. for both operation and release	1 ms max. for both operation and release	
Control output	Output current: 1.5 to 4 mA; load current: 80 mA max. (output residual voltage: 1 V max.)		
Ambient illumination	Incandescent lamp: Illumination on optical spot: 3,000 lx max. Sunlight: Illumination on optical spot: 10,000 lx max.		
Ambient temperature	Operating: -25°C to 55°C (with no icing) Storage: -40°C to 70°C (with no icing)		
Ambient humidity	Operating: 35% to 85% Storage: 35% to 95%		
Insulation resistance	20 M Ω min. (at 500 VDC)		
Dielectric strength	1,000 VAC, 50/60 Hz for 1 min		
Vibration resistance	Destruction: 10 to 55 Hz, 1.5-mm double amplitude for 2 hrs each in X, Y, and Z directions		
Shock resistance	Destruction: 500 m/s ² (approx. 50G) for 3 times each in X, Y, and Z directions		
Enclosure rating	IEC: IP66		

Engineering Data

Parallel Operating Range (Typical)

E3R-5E4

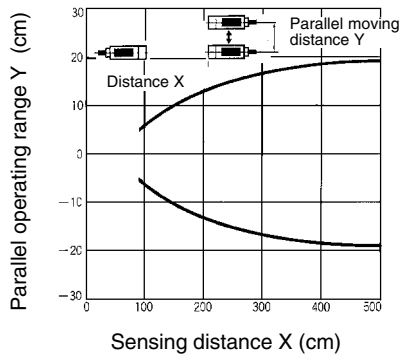

E3R-R2E4

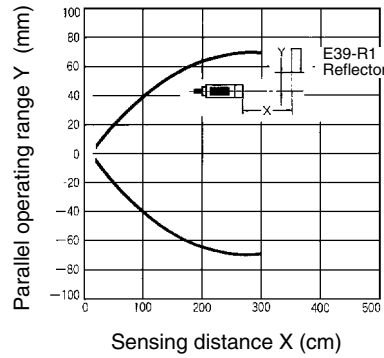

Operating Range (Typical)

E3R-DS30E4

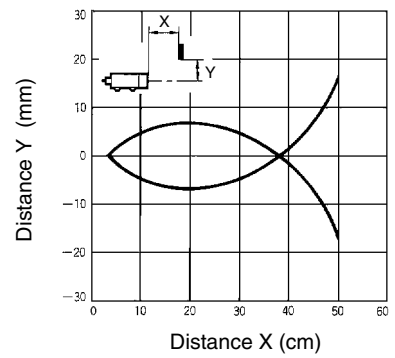

Excess Gain vs. Set Distance (Typical)

E3R-5E4

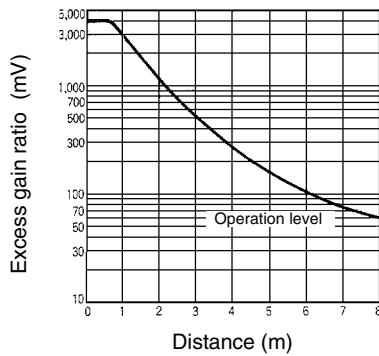

E3R-R2E4

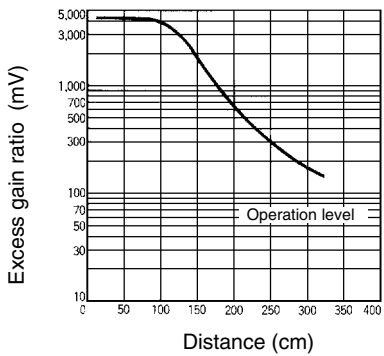

E3R-DS30E4

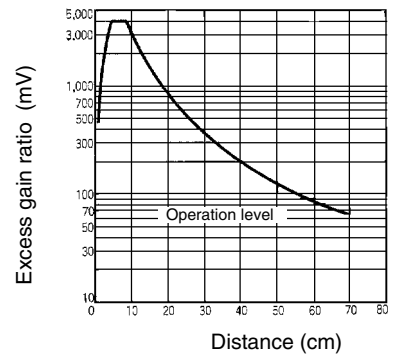

Slit Characteristics (Excess Gain vs. Distance) (Typical)

E3R-5E4

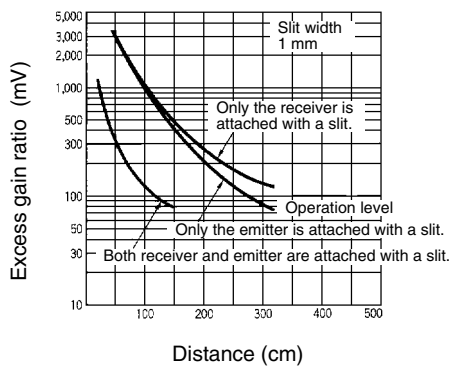

E3R-5E4

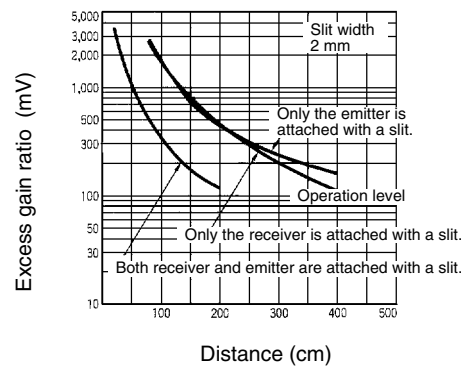

Operation

■ Output Circuits

Connection method	Output transistor	Output circuits
Short-circuit the pink wire and brown wire.	ON when light is received.	
Short-circuit the pink wire and blue wire or open the pink wire.	ON when light is not received.	

■ Timing Chart

Connection method	Output transistor	Output circuits
Short-circuit the pink wire and brown wire.	ON when light is received.	<p>Light received Light not received</p> <p>Light indicator (Red) ON OFF</p> <p>Output transistor ON OFF</p> <p>Load (relay) Operate Release</p> <p>Output voltage (logic) H L</p> <p>(Between brown and black)</p> <p>(Between blue and black)</p>
Short-circuit the pink wire and blue wire or open the pink wire.	ON when light is not received.	<p>Light received Light not received</p> <p>Light indicator (Red) ON OFF</p> <p>Output transistor ON OFF</p> <p>Load (relay) Operate Release</p> <p>Output voltage (logic) H L</p> <p>(Between brown and black)</p> <p>(Between blue and black)</p>

Dimensions

Note: All units are in millimeters unless otherwise indicated.

E3R-5□□

Emitter: 4-mm dia., 0.12 x 18, 2 cores
 Standard length: 2 m
 Receiver: 4.5-mm dia., 0.12 x 18, 4 cores
 Standard length: 2 m
 Weight: approx. 165 g

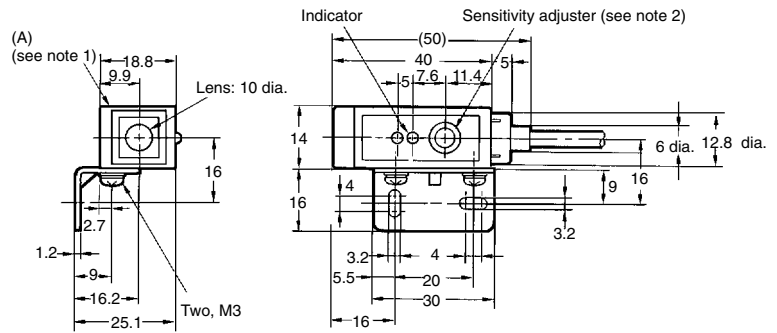
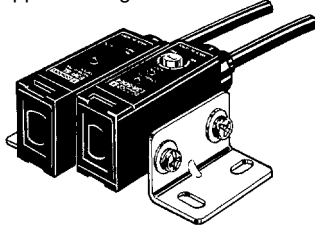

Note: 1. A mounting bracket can be attached to side A.
 2. Receiver only.

E3R-R2E4 E3R-DS30E4

4.5-mm dia., 0.12 x 18, 4 cores
 Standard length: 2 m
 Weight: approx. 165 g

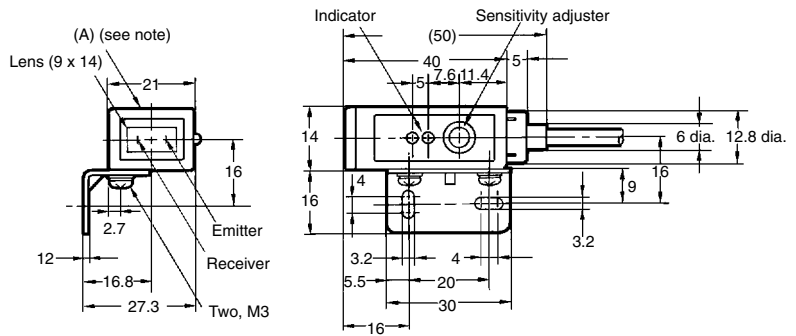
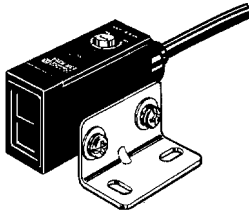

Note: A mounting bracket can be attached to side A.

Accessories (Order Separately)

E39-R1 Retroreflector

(Retroreflective type)

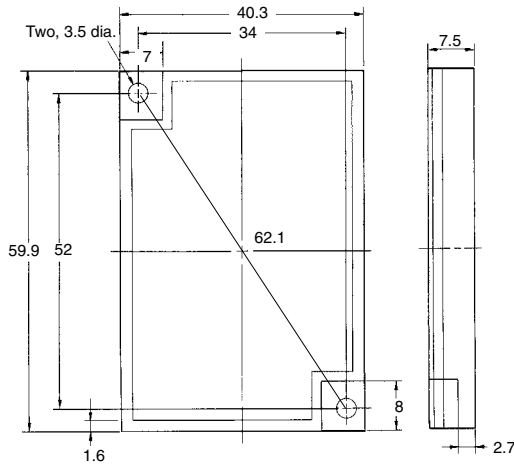
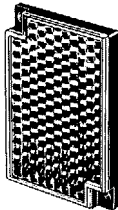

E39-S5 1-mm-wide Slit

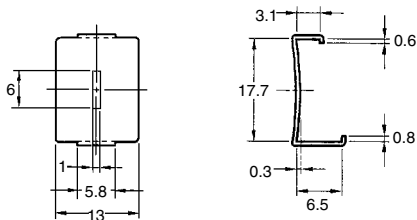

E39-S5 2-mm-wide Slit

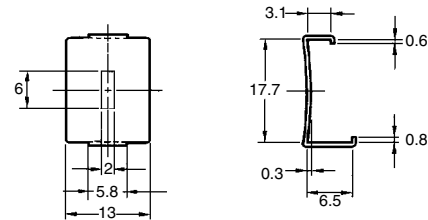

Installation

■ Connections

With Sensor Controller (S3D2)

The operation of the sensor is reversible with the signal input selector of the S3D2.

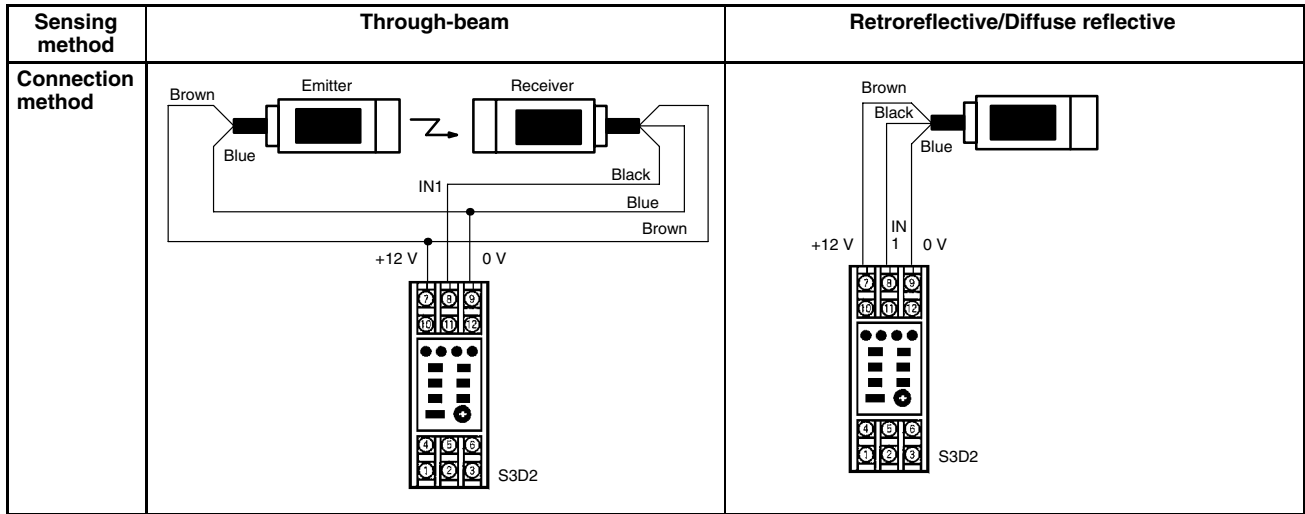

Precautions

⚠ WARNING

This product is not designed or rated for ensuring safety of persons.
Do not use it for such purposes.

**E39-S5 Slit**

Use the E39-S5 for sensing thin objects or if the sensing position is near the center of the lens. The E39-S5 with 1-mm-wide slit and that with 2-mm-wide slit are available.

The slit on the Emitter and that on the Receiver must be in the same direction.

Terms and Conditions of Sale

- Offer; Acceptance.** These terms and conditions (these "Terms") are deemed part of all quotes, agreements, purchase orders, acknowledgments, price lists, catalogs, manuals, brochures and other documents, whether electronic or in writing, relating to the sale of products or services (collectively, the "Products") by Omron Electronics LLC and its subsidiary companies ("Omron"). Omron objects to any terms or conditions proposed in Buyer's purchase order or other documents which are inconsistent with, or in addition to, these Terms.
- Prices; Payment Terms.** All prices stated are current, subject to change without notice by Omron. Omron reserves the right to increase or decrease prices on any unshipped portions of outstanding orders. Payments for Products are due net 30 days unless otherwise stated in the invoice.
- Discounts.** Cash discounts, if any, will apply only on the net amount of invoices sent to Buyer after deducting transportation charges, taxes and duties, and will be allowed only if (i) the invoice is paid according to Omron's payment terms and (ii) Buyer has no past due amounts.
- Interest.** Omron, at its option, may charge Buyer 1-1/2% interest per month or the maximum legal rate, whichever is less, on any balance not paid within the stated terms.
- Orders.** Omron will accept no order less than \$200 net billing.
- Governmental Approvals.** Buyer shall be responsible for, and shall bear all costs involved in, obtaining any government approvals required for the importation or sale of the Products.
- Taxes.** All taxes, duties and other governmental charges (other than general real property and income taxes), including any interest or penalties thereon, imposed directly or indirectly on Omron or required to be collected directly or indirectly by Omron for the manufacture, production, sale, delivery, importation, consumption or use of the Products sold hereunder (including customs duties and sales, excise, use, turnover and license taxes) shall be charged to and remitted by Buyer to Omron.
- Financial.** If the financial position of Buyer at any time becomes unsatisfactory to Omron, Omron reserves the right to stop shipments or require satisfactory security or payment in advance. If Buyer fails to make payment or otherwise comply with these Terms or any related agreement, Omron may (without liability and in addition to other remedies) cancel any unshipped portion of Products sold hereunder and stop any Products in transit until Buyer pays all amounts, including amounts payable hereunder, whether or not then due, which are owing to it by Buyer. Buyer shall in any event remain liable for all unpaid accounts.
- Cancellation; Etc.** Orders are not subject to rescheduling or cancellation unless Buyer indemnifies Omron against all related costs or expenses.
- Force Majeure.** Omron shall not be liable for any delay or failure in delivery resulting from causes beyond its control, including earthquakes, fires, floods, strikes or other labor disputes, shortage of labor or materials, accidents to machinery, acts of sabotage, riots, delay in or lack of transportation or the requirements of any government authority.
- Shipping; Delivery.** Unless otherwise expressly agreed in writing by Omron:
 - Shipments shall be by a carrier selected by Omron; Omron will not drop ship except in "break down" situations.
 - Such carrier shall act as the agent of Buyer and delivery to such carrier shall constitute delivery to Buyer;
 - All sales and shipments of Products shall be FOB shipping point (unless otherwise stated in writing by Omron), at which point title and risk of loss shall pass from Omron to Buyer; provided that Omron shall retain a security interest in the Products until the full purchase price is paid;
 - Delivery and shipping dates are estimates only; and
 - Omron will package Products as it deems proper for protection against normal handling and extra charges apply to special conditions.
- Claims.** Any claim by Buyer against Omron for shortage or damage to the Products occurring before delivery to the carrier must be presented in writing to Omron within 30 days of receipt of shipment and include the original transportation bill signed by the carrier noting that the carrier received the Products from Omron in the condition claimed.
- Warranties.** (a) **Exclusive Warranty.** Omron's exclusive warranty is that the Products will be free from defects in materials and workmanship for a period of twelve months from the date of sale by Omron (or such other period expressed in writing by Omron). Omron disclaims all other warranties, express or implied. (b) **Limitations.** OMRON MAKES NO WARRANTY OR REPRESENTATION, EXPRESS OR IMPLIED, ABOUT NON-INFRINGEMENT, MERCHANTABILITY OR FITNESS FOR A PARTICULAR PURPOSE OF THE PRODUCTS. BUYER ACKNOWLEDGES THAT IT ALONE HAS DETERMINED THAT THE PRODUCTS WILL SUITABLY MEET THE REQUIREMENTS OF THEIR INTENDED USE. Omron further disclaims all warranties and responsibility of any type for claims or expenses based on infringement by the Products or otherwise of any intellectual property right. (c) **Buyer Remedy.** Omron's sole obligation hereunder shall be, at Omron's election, to (i) replace (in the form originally shipped with Buyer responsible for labor charges for removal or replacement thereof) the non-complying Product, (ii) repair the non-complying Product, or (iii) repay or credit Buyer an amount equal to the purchase price of the non-complying Product; provided that in no event shall Omron be responsible for warranty, repair, indemnity or any other claims or expenses regarding the Products unless Omron's analysis confirms that the Products were properly handled, stored, installed and maintained and not subject to contamination, abuse, misuse or inappropriate modification. Return of any Products by Buyer must be approved in writing by Omron before shipment. Omron Companies shall not be liable for the suitability or unsuitability or the results from the use of Products in combination with any electrical or electronic components, circuits, system assemblies or any other materials or substances or environments. Any advice, recommendations or information given orally or in writing, are not to be construed as an amendment or addition to the above warranty. See <http://oeweb.omron.com> or contact your Omron representative for published information.
- Limitation on Liability; Etc.** OMRON COMPANIES SHALL NOT BE LIABLE FOR SPECIAL, INDIRECT, INCIDENTAL, OR CONSEQUENTIAL DAMAGES, LOSS OF PROFITS OR PRODUCTION OR COMMERCIAL LOSS IN ANY WAY CONNECTED WITH THE PRODUCTS, WHETHER SUCH CLAIM IS BASED IN CONTRACT, WARRANTY, NEGLIGENCE OR STRICT LIABILITY. Further, in no event shall liability of Omron Companies exceed the individual price of the Product on which liability is asserted.
- Indemnities.** Buyer shall indemnify and hold harmless Omron Companies and their employees from and against all liabilities, losses, claims, costs and expenses (including attorney's fees and expenses) related to any claim, investigation, litigation or proceeding (whether or not Omron is a party) which arises or is alleged to arise from Buyer's acts or omissions under these Terms or in any way with respect to the Products. Without limiting the foregoing, Buyer (at its own expense) shall indemnify and hold harmless Omron and defend or settle any action brought against such Companies to the extent based on a claim that any Product made to Buyer specifications infringed intellectual property rights of another party.
- Property; Confidentiality.** Any intellectual property in the Products is the exclusive property of Omron Companies and Buyer shall not attempt to duplicate it in any way without the written permission of Omron. Notwithstanding any charges to Buyer for engineering or tooling, all engineering and tooling shall remain the exclusive property of Omron. All information and materials supplied by Omron to Buyer relating to the Products are confidential and proprietary, and Buyer shall limit distribution thereof to its trusted employees and strictly prevent disclosure to any third party.
- Export Controls.** Buyer shall comply with all applicable laws, regulations and licenses regarding (i) export of products or information; (ii) sale of products to "forbidden" or other proscribed persons; and (iii) disclosure to non-citizens of regulated technology or information.
- Miscellaneous.** (a) **Waiver.** No failure or delay by Omron in exercising any right and no course of dealing between Buyer and Omron shall operate as a waiver of rights by Omron. (b) **Assignment.** Buyer may not assign its rights hereunder without Omron's written consent. (c) **Law.** These Terms are governed by the law of the jurisdiction of the home office of the Omron company from which Buyer is purchasing the Products (without regard to conflict of law principles). (d) **Amendment.** These Terms constitute the entire agreement between Buyer and Omron relating to the Products, and no provision may be changed or waived unless in writing signed by the parties. (e) **Severability.** If any provision hereof is rendered ineffective or invalid, such provision shall not invalidate any other provision. (f) **Setoff.** Buyer shall have no right to set off any amounts against the amount owing in respect of this invoice. (g) **Definitions.** As used herein, "including" means "including without limitation"; and "Omron Companies" (or similar words) mean Omron Corporation and any direct or indirect subsidiary or affiliate thereof.

Certain Precautions on Specifications and Use

- Suitability of Use.** Omron Companies shall not be responsible for conformity with any standards, codes or regulations which apply to the combination of the Product in the Buyer's application or use of the Product. At Buyer's request, Omron will provide applicable third party certification documents identifying ratings and limitations of use which apply to the Product. This information by itself is not sufficient for a complete determination of the suitability of the Product in combination with the end product, machine, system, or other application or use. Buyer shall be solely responsible for determining appropriateness of the particular Product with respect to Buyer's application, product or system. Buyer shall take application responsibility in all cases but the following is a non-exhaustive list of applications for which particular attention must be given:
 - Outdoor use, uses involving potential chemical contamination or electrical interference, or conditions or uses not described in this document.
 - Use in consumer products or any use in significant quantities.
 - Energy control systems, combustion systems, railroad systems, aviation systems, medical equipment, amusement machines, vehicles, safety equipment, and installations subject to separate industry or government regulations.
 - Systems, machines and equipment that could present a risk to life or property. Please know and observe all prohibitions of use applicable to this Product.
 NEVER USE THE PRODUCT FOR AN APPLICATION INVOLVING SERIOUS RISK TO LIFE OR PROPERTY OR IN LARGE QUANTITIES WITHOUT ENSURING THAT THE SYSTEM AS A WHOLE HAS BEEN DESIGNED TO ADDRESS THE RISKS, AND THAT THE OMRON'S PRODUCT IS PROPERLY RATED AND INSTALLED FOR THE INTENDED USE WITHIN THE OVERALL EQUIPMENT OR SYSTEM.
- Programmable Products.** Omron Companies shall not be responsible for the user's programming of a programmable Product, or any consequence thereof.
- Performance Data.** Data presented in Omron Company websites, catalogs and other materials is provided as a guide for the user in determining suitability and does not constitute a warranty. It may represent the result of Omron's test conditions, and the user must correlate it to actual application requirements. Actual performance is subject to the Omron's Warranty and Limitations of Liability.
- Change in Specifications.** Product specifications and accessories may be changed at any time based on improvements and other reasons. It is our practice to change part numbers when published ratings or features are changed, or when significant construction changes are made. However, some specifications of the Product may be changed without any notice. When in doubt, special part numbers may be assigned to fix or establish key specifications for your application. Please consult with your Omron's representative at any time to confirm actual specifications of purchased Product.
- Errors and Omissions.** Information presented by Omron Companies has been checked and is believed to be accurate; however, no responsibility is assumed for clerical, typographical or proofreading errors or omissions.

Complete "Terms and Conditions of Sale" for product purchase and use are on Omron's website at www.omron247.com – under the "About Us" tab, in the Legal Matters section.

ALL DIMENSIONS SHOWN ARE IN MILLIMETERS.

To convert millimeters into inches, multiply by 0.03937. To convert grams into ounces, multiply by 0.03527.



OMRON ELECTRONICS LLC

1 Commerce Drive
Schaumburg, IL 60173
Tel: 847.843.7900

For U.S. technical support or other inquiries: 800.556.6766

OMRON CANADA, INC.

885 Milner Avenue
Toronto, Ontario M1B 5V8
Tel: 416.286.6465

MEXICO SALES OFFICES

Mexico, D.F. 555.660.3144
Ciudad Juárez 656.623.7083
Monterrey, N.L. 818.377.4281
Querétaro 442.135.4510

BRAZIL SALES OFFICE

Sao Paulo 55.11.2101.6310

ARGENTINA SALES OFFICE

Cono Sur 54.114.787.1129

CHILE SALES OFFICE

Santiago 562.206.4592

OTHER LATIN AMERICAN SALES

mela@omron.com

OMRON ON-LINE

Global -

www.omron.com

USA -

www.omron247.com

Canada -

www.omron.ca

Brazil -

www.omron.com.br

Latin America -

www.espanol.omron.com