

PLEASE CHECK WWW.MOLEX.COM FOR LATEST PART INFORMATION

Part Number: [39-30-2031](#)
Status: **Active**
Overview: [Mini-Fit Jr.™ Power Connectors](#)
Description: Mini-Fit® Jr. Header, Single Row, Vertical, with Snap-in Plastic Peg PCBLock, 3 Circuits, PA Polyamide Nylon 6/6, UL 94V-2, 0.76µm Gold (Au) Selective Plating, without Drain Holes

Documents:

3D Model	Test Summary TS-5556-002 (PDF)
Drawing (PDF)	RoHS Certificate of Compliance (PDF)
Product Specification PS-5556-001 (PDF)	

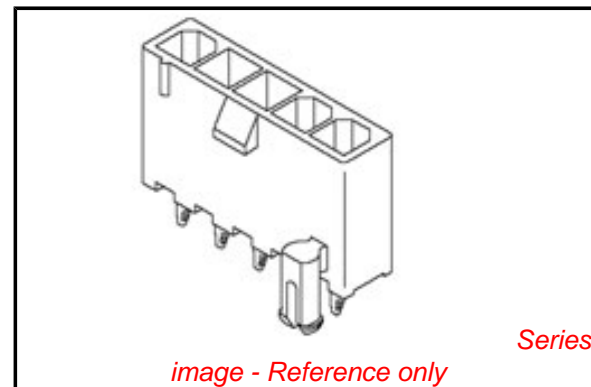

Agency Certification

CSA	LR19980
UL	E29179

General

Product Family	PCB Headers
Series	5566
Application	Power, Wire-to-Board
Comments	The 5566 header should be used with standard Mini-Fit® female terminals. If increased amperage of up to 13A per circuit is needed, please consider using the Mini-Fit® Plus HCS family 45750 terminals with 46014 headers; . See Molex Product specification for current de-rating information.
Overview	Mini-Fit Jr.™ Power Connectors
Product Name	Mini-Fit Jr.™
UPC	800754379946

Physical

Breakaway	No
Circuits (Loaded)	3
Circuits (maximum)	3
Color - Resin	Natural
Durability (mating cycles max)	30
First Mate / Last Break	No
Flammability	94V-2
Glow-Wire Compliant	No
Guide to Mating Part	No
Keying to Mating Part	None
Lock to Mating Part	Yes
Material - Metal	Brass
Material - Plating Mating	Gold
Material - Plating Termination	Tin
Material - Resin	Nylon
Net Weight	0.801/g
Number of Rows	1
Orientation	Vertical
PC Tail Length	3.50mm
PCB Locator	Yes
PCB Retention	Yes
PCB Thickness - Recommended	1.60mm
Packaging Type	Tray
Pitch - Mating Interface	4.20mm
Pitch - Termination Interface	4.20mm

EU RoHS

ELV and RoHS Compliant
REACH SVHC
 Not Reviewed
Low-Halogen Status
Low-Halogen

China RoHS



Need more information on product environmental compliance?

Email productcompliance@molex.com
 For a multiple part number RoHS Certificate of Compliance, [click here](#)

Please visit the [Contact Us](#) section for any non-product compliance questions.

Search Parts in this Series

[5566Series](#)

Mates With

[5557 Mini-Fit Jr.™ Receptacle Housing](#)

Polarized to Mating Part	Yes
Polarized to PCB	Yes
Shrouded	Fully
Stackable	No
Surface Mount Compatible (SMC)	No
Temperature Range - Operating	-40°C to +105°C
Termination Interface: Style	Through Hole

Electrical

Current - Maximum per Contact	9A
Voltage - Maximum	600V

Solder Process Data

Duration at Max. Process Temperature (seconds)	5
Lead-free Process Capability	Wave Capable (TH only)
Max. Cycles at Max. Process Temperature	1
Process Temperature max. C	240

Material Info

Old Part Number	5566-03A3GS
-----------------	-------------

Reference - Drawing Numbers

Product Specification	PS-5556-001, RPS-5556-004
Sales Drawing	SDA-5566-03*3*
Test Summary	TS-5556-002

This document was generated on 02/17/2015

PLEASE CHECK WWW.MOLEX.COM FOR LATEST PART INFORMATION