



iServer MicroServer™

Internet Counter



Operator's Manual

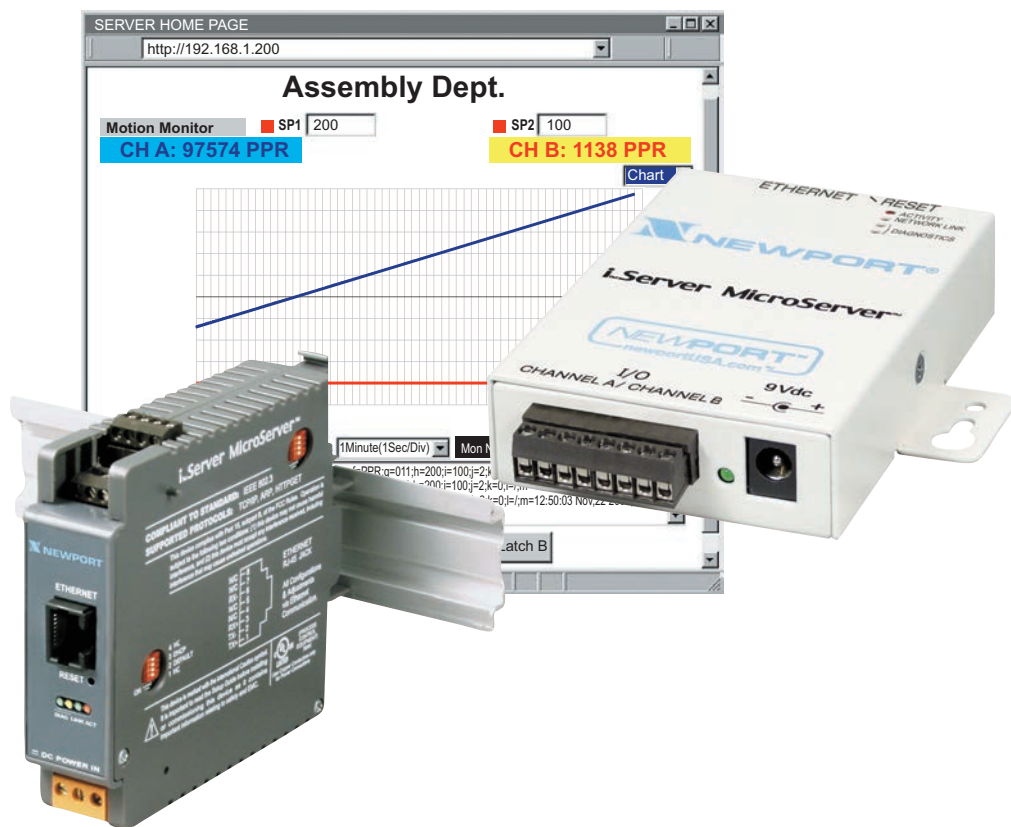

 **NEWPORT** Electronics, Inc.
<http://www.newportUS.com/iServer>

Additional products from

NEWPORT Electronics, Inc.

Counters	Rate Meters
Frequency Meters	Timers
PID Controllers	Totalizers
Clock/Timers	Strain Gauge Meters
Printers	Voltmeters
Process Meters	Multimeters
On/Off Controllers	Soldering Iron Testers
Recorders	pH pens
Relative Humidity	pH Controllers
Transmitters	pH Electrodes
Thermocouples	RTDs
Thermistors	Thermowells
Wire	Flow Sensors
Wireless	

For Immediate Assistance
In the U.S.A. and Canada: 1-800-NEWPORT[®]
In Mexico: (95) 800-NEWPORTSM
Or call your local NEWPORT Office.

NEWPORTnetSM On-Line Service
www.newportUS.com

Internet e-mail
info@newportUS.com

It is the policy of NEWPORT to comply with all worldwide safety and EMC/EMI regulations that apply. NEWPORT is constantly pursuing certification of its products to the European New Approach Directives. NEWPORT will add the CE mark to every appropriate device upon certification.

The information contained in this document is believed to be correct but NEWPORT Electronics, Inc. accepts no liability for any errors it contains, and reserves the right to alter specifications without notice.

WARNING: These products are not designed for use in, and should not be used for, patient connected applications.

TRADEMARK NOTICE: , **NEWPORT[®]**, **NEWPORT[®]** and **newportUS.com** are trademarks of NEWPORT Electronics, Inc.

PATENT NOTICE: This product is covered by one or more of the following patents: U.S. Pat. No. Des. 336,895; 5,274,577/ CANADA 2052599; 2052600/ ITALY 1249456; 1250938 / FRANCE BREVET No. 91 12756 / SPAIN 2039150; 2048066 / UK PATENT No. GB2 249 837; GB2 248 954 / GERMANY DE 41 34398 C2. The  is a Trademark of OMEGA Engineering, Inc. Used Under License. Other US and International Patents pending or applied for.



This device is marked with the international caution symbol. It is important to read the Setup Guide before installing or commissioning this device as it contains important information relating to safety and EMC.

TABLE OF CONTENTS

Part 1: Introduction		
1.1	Safety and EMC Considerations	2
1.2	Before You Begin	2
1.3	Description	2
Part 2: Hardware		
2.1	Mounting	3
2.1.1	Mounting the Wall Mount iServer	3
2.1.2	Mounting the DIN Rail iServer	4
2.1.3	Removal from a DIN Rail	4
2.2	DIP Switches	5
2.2.1	SW1 DIP Switch Usage	5
2.2.2	SW3 DIP Switch Usage	6
2.3	Parts of iServer Unit	7
2.4	Wiring	8
2.5	Network Communication Interfaces	9
2.5.1	10 Base-T RJ-45 Pinout	9
2.5.2	10 Base-T Crossover Wiring	9
Part 3: Network Configuration		
3.1	Network Protocols	10
3.2	Ethernet (MAC) Address	10
3.3	DHCP	11
3.4	DNS	11
3.5	IP Address	12
3.5.1	Default IP Address	12
3.6	Port Number	12
Part 4: Operations		
4.0	Testing the Connection	13
4.1	iCONNECT Software	14
4.2	Setting a new IP Address over the Network	15
4.3	Setup and Operation using a Web Browser	16
4.4	Login	17
4.5	Java Runtime Environment 1.7 Setup Instructions	17
4.5.1	Browser Proxy Selection	18
4.6	iServer Operation Basic Menus	19
4.6.1	Chart Descriptions	19
4.7	Device Configuration Page Items' Description and Concepts of Setup	22
4.7.1	Device Type/Mode Selection	23
4.7.1.1	Frequency Mode	23
4.7.1.2	Totalizer Mode	24
4.7.1.3	Batch Mode	26
4.7.1.4	A-B F Mode	28
4.7.1.5	A-B T Mode	30
4.7.1.6	Quadrature Mode	32
4.7.1.7	Totalizer Gate Mode	34
4.7.2	SetPoint, Alarm and Alarm Output Operation Config	36
4.7.2.1	SP1 Value	36
4.7.2.2	SP1 Latch Mode	36
4.7.2.3	SP1 Active Mode	36
4.7.2.4	SP1 Dead Band	36
4.7.2.5	SP1 Active Status	36
4.7.2.6	SP2 Value	37
4.7.2.7	SP2 Latch Mode	37
4.7.2.8	SP2 Active Mode	37
4.7.2.9	SP2 Dead Band	37
4.7.2.10	SP2 Active Status	37
4.7.3	Title Definability Utility	37

4.7.4	Operation Condition Parameters	38
4.7.4.1	Input Reading Scale & Offset	39
4.7.4.1.1	A Scale	39
4.7.4.1.2	A Offset	39
4.7.4.1.3	B Scale	39
4.7.4.1.4	B Offset	39
4.7.4.1.5	A Gate Time (ms)	39
4.7.4.1.6	B Gate Time (ms)	39
4.7.4.1.7	A Debounce Time (ms)	39
4.7.4.1.8	B Debounce Time (ms)	39
4.7.4.1.9	Reading Format	40
4.7.4.1.10	Number of Digit	40
4.7.4.1.11	Decimal Point	40
4.7.4.2	Counting Mode	40
4.7.4.2.1	Combined A-B Mode	40
4.7.4.2.2	Counter Mode	40
4.7.5	Terminal/Remote (Tunneling) Server Setup	41
4.7.5.1	TCP/UDP	41
4.7.5.2	Server Type	41
4.7.5.3	Number of Connections	41
4.7.5.4	Port	42
4.7.5.5	Remote Access	42
4.7.5.6	Remote Port	42
4.7.5.7	Remote IP Address	42
4.7.5.8	List of Available Communication Commands	43
4.8	Telnet Setup	44
4.8.1	Send Remote Reset	44
4.8.2	Send Commands Manually	44
4.8.3	Sending *SRP command for Data Parameter String	45
4.8.4	Remote Display Format for Measurement Readings	45
4.8.5	A-B Mode	45
4.9	HTTPGET Program	46
4.9.1	HTTPGET using Port 1000	46
4.9.2	HTTPGET and ARP to setup Device IP Address	47
4.10	ARP Protocol	48
4.11	Remote Access (Tunneling)	49
4.11.1	Local iServer	50
4.11.2	Remote iServer	51
4.12	Access Control Descriptions and Functions	52
4.13	iLOG Software	53
4.14	Mail Notifier Software	54
4.14.1	Installation	54
4.14.2	Program Options Setup and Configuration	55
4.14.2.1	Sending Email Messages to a Cell Phone	55
4.14.3	Device Setting Setup and Configuration	56
	Part 5: Specifications	56
	Part 6: Factory Preset Values	58
Appendix A	Glossary	59
Appendix B	IP Address	60
Appendix C	IP Netmask	61
Appendix D	ASCII Chart	62
	ASCII Chart Control Codes	63
Appendix E	iLog Error Messages	65
	Part 7: Approvals Informatio	
7.1	Electromagnetic Compatibility (EMC)	66
7.2	FCC	66

LIST OF FIGURES:

Figure 2.1	Mounting - Wall Mount iServer	3
Figure 2.2	Mounting - DIN Rail iServer	4
Figure 2.3	Removal - DIN Rail iServer	4
Figure 2.4a	DIP Switch SW1 - Wall Mount iServer	5
Figure 2.4b	DIP Switch SW1 - DIN Rail iServer	5
Figure 2.5a	DIP Switch SW3 - Wall Mount iServer	6
Figure 2.5b	DIP Switch SW3 - DIN Rail iServer	6
Figure 2.6	Parts of iServer Unit.....	7
Figure 2.7a	Wall Mount iServer 8 Position Connector	8
Figure 2.7b	DIN Rail iServer 8 Position Connector	8
Figure 2.8	RJ45 Pinout	9
Figure 2.9	10Base-T Crossover Cable Wiring	9
Figure 3.1	Labeling	10
Figure 3.2	DIP Switch SW1	11
Figure 4.1	Pinging the iServer from MS-DOS Prompt	13
Figure 4.2	Assigning an IP Address using iCONNECT	14
Figure 4.3	Accessing the iServer's Home Page	14
Figure 4.4	Access Control	15
Figure 4.5	iServer Home Page Menu	16
Figure 4.6	Login Password	17
Figure 4.7	Java 1.7.x Screen Shot	17
Figure 4.8	Chart Descriptions	19
Figure 4.9	Configuration/Device Setup	22
Figure 4.10	Example of Totalizer Mode	25
Figure 4.11	Example of Batch Mode	27
Figure 4.12	Example of A-B F Mode	29
Figure 4.13	Example of A-B T Mode with Bar Chart.....	31
Figure 4.14	Example of Quadrature Mode	33
Figure 4.15	Example of Totalizer Gate Mode	35
Figure 4.16	Example of SetPoint / Alarm Configuration	36
Figure 4.17	Example of Title Definability Utility	37
Figure 4.18	Example of Operation Condition Parameters	38
Figure 4.19	Terminal / Remote (Tunneling) Server Setup	41
Figure 4.20	Telnet Login into the iServer	44
Figure 4.21	Response of Command *SRP inquiry Using Terminal Setup.....	45
Figure 4.22	Dual Frequency Counter in A-B (+) Mode is Displayed Under Continuous Mode Using Remote Terminal Server.....	45
Figure 4.23	Example of Using Httpget Program.....	47
Figure 4.24	ARP Commands and Responses	49
Figure 4.25	Device-to-Device Communication	49
Figure 4.26	Local iServer Config. Terminal Server/Remote Access.....	50
Figure 4.27	Remote iServer Config. Terminal Server/Remote Access.....	51
Figure 4.28	Access Control	52
Figure 4.29	iLOG Software Logging Data	53
Figure 4.30	iServer Mail Notifier Main Window	54
Figure 4.31	iServer Mail Notifier Profile Setup	55
Figure 4.32	iServer Mail Notifier Device Setting	56

LIST OF TABLES:

Table 2.1	Parts of iServer Unit.....	7
Table 4.1	Message Item Window Description	21

Table 4.2 **List of Communication Commands43**

NOTES, WARNINGS and CAUTIONS

Information that is especially important to note is identified by the following labels:

- **NOTE**
- **WARNING or CAUTION**
- **IMPORTANT**
- **TIP**

Note ⓘ

NOTE: Provides you with information that is important to successfully setup and use the iServer.



CAUTION: Tells you about the risk of electrical shock.



CAUTION: Risk of danger. Tells you of circumstances or practices that can effect the instrument's functionality and must refer to accompanying documents.

Tip ⓘ

TIP: Provides you helpful hints.

FEATURES

- **Displays Rate, Frequency, Pulse, Total, Batch, and Quadrature over Ethernet and Internet**
- **Web based interface**
- **No special software needed**
- **Up to 500 KHz input**
- **Chart, Bar Graph, and X/Y displays**
- **2 Channel input/output**
- **Custom firmware and private labeling for OEM's**

PART 1

INTRODUCTION

1.1 Safety and EMC Considerations

Refer to the CE Approvals Section. Always use a power supply, which complies with EN 60950 safety standard.

EMC Considerations

- Whenever EMC is an issue, always use shielded cables.
- Never run signal and power wires in the same conduit.
- Use twisted-pair wires for signal connections.
- Install Ferrite Bead(s) on signal wires close to the instrument if EMC problems persist.

Failure to follow all instructions and warnings may result in injury!

1.2 Before You Begin

Inspecting Your Shipment: Remove the packing slip and verify that you have received everything listed. Inspect the container and equipment for signs of damage as soon as you receive the shipment. Note any evidence of rough handling in transit. Immediately report any damage to the shipping agent. The carrier will not honor damage claims unless all shipping material is saved for inspection. After examining and removing the contents, save the packing material and carton in the event reshipment is necessary.

Customer Service: If you need assistance, please contact the Customer Service Department nearest you.

Manuals, Software: The latest Operation Manual as well as free software and iServer Mail Notifier are available at **the website listed on the cover page of this manual or on the CD-ROM enclosed with your shipment.**

1.3 Description

The iServer Internet Counter puts “dumb” data on the World Wide Web. This revolutionary technology transmits virtually any conventional counting application up to 500 KHz over an Ethernet network or the Internet.

This iServer can count contacts from the simplest button or switch, as well as count pulses from most any conventional transducer such as a proximity sensor or quadrature encoder. The iServer converts raw data to intelligent information.

The iServer can be configured as a virtual version of most any Rate/Frequency Meter, Totalizer, or Batch Controller. It is a node on an Ethernet network with a unique IP address and serves the data to any authorized computer on a LAN, WAN or the Internet. Set points can be programmed to trigger an alarm and even send email automatically to a Web-enabled cell phone.

No special software or drivers are required. A user can type the unit's IP address (or assigned name) on the address line of a Web Browser such as Internet Explorer. The device then serves actual JAVA based active Web pages that present the information numerically and graphically.

The iServer supports the common Ethernet/Internet Protocols: TCP, UDP, ARP, Telnet, DHCP, DNS, and HTTP. The device integrates seamlessly with data acquisition and industrial automation program. The iServer offers password protection for security.

The iServer provides two discrete input/output channels. For applications that use two inputs, it can perform calculations with the data from channels A and B that can be presented numerically or graphically, such as charting position on an XY graph.

PART 2 HARDWARE

2.1 Mounting

2.1.1 Mounting the Wall Mount iServer

Position unit where required. Mark and drill holes as required.

Note If unit is to be mounted on a flat surface, you may take the bottom rubber feet off the unit.

Note It is recommended that you ground your unit by wrapping a wire around the mounting tab screw and tightening a lock washer so that it embeds itself into the metal of the mounting tab.

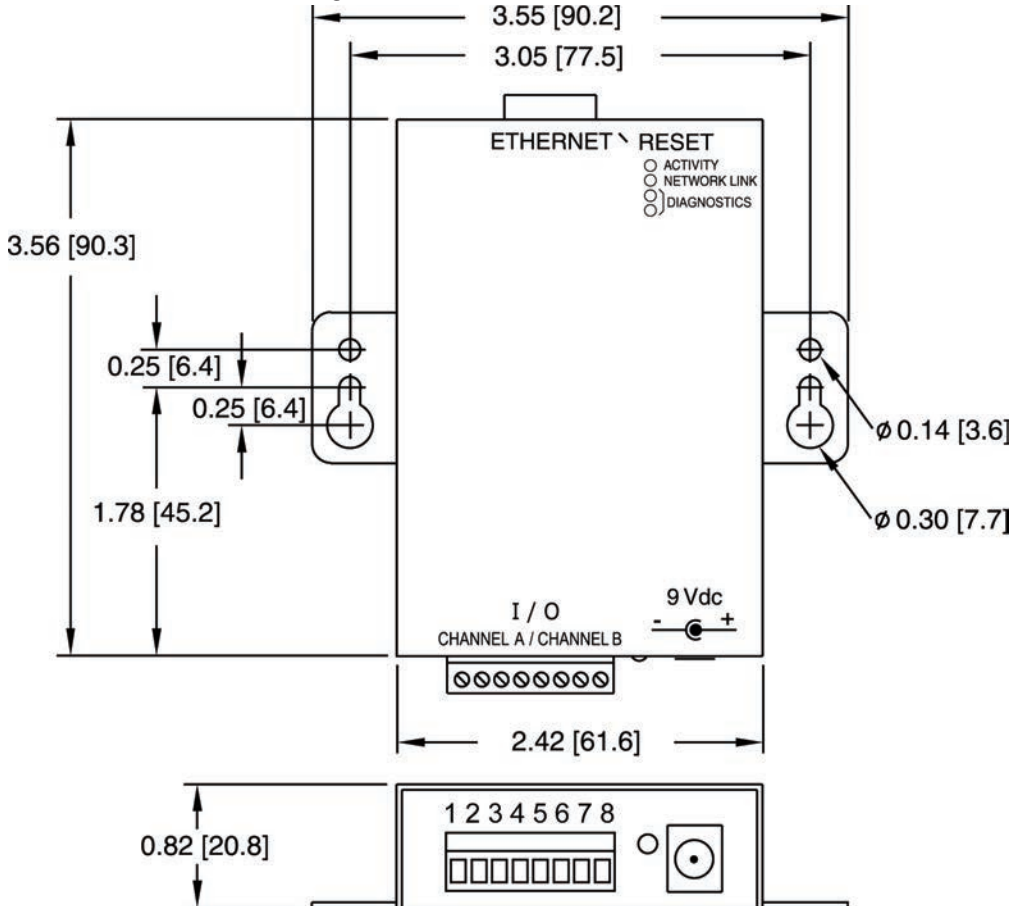

Figure 2.1 Mounting - Wall Mount iServer

2.1.2 Mounting the DIN Rail iServer

To install unit onto DIN Rail:

- a) Tilt unit, position mounting slot onto DIN Rail, as shown.
- b) Push unit towards DIN Rail and it will snap into place.

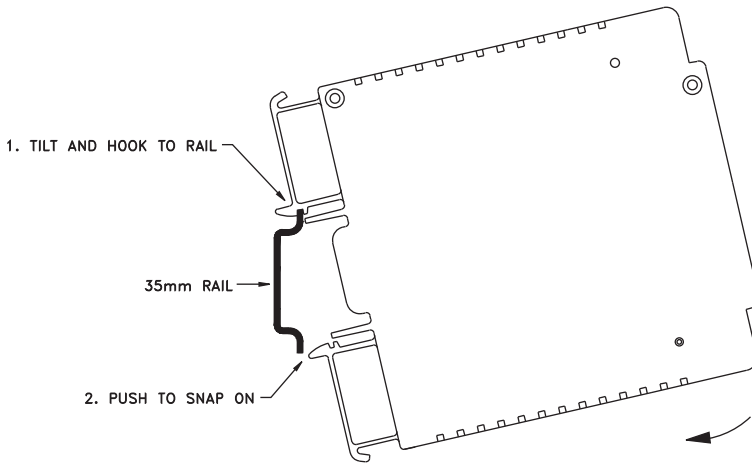

Figure 2.2 Mounting - DIN Rail iServer

2.1.3 Removal from a DIN Rail

- a) Insert flat screw-driver into tab and push downwards.
- b) Unit will detach from DIN Rail.

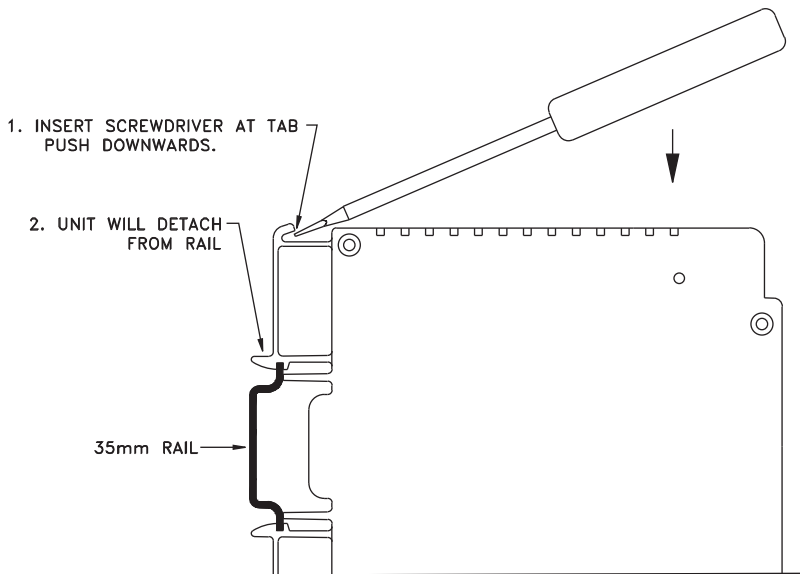

Figure 2.3 Removal - DIN Rail iServer

2.2 DIP Switches

2.2.1 SW1 DIP Switch Usage

The iServer is shipped with all SW1 DIP switches in "OFF" position.

- 1) N/C - not used
- 2) To change to default factory settings
- 3) To enable/disable DHCP
- 4) N/C - not used

Note

To set the iServer to factory default settings, slide SW1 DIP switch #2 to ON position. Power the iServer on and wait about 10 seconds until the iServer fully boots up. Set the SW1 DIP switch #2 back to OFF position (it does not matter if the iServer is powered ON or OFF, just make sure that the DIP switch is set to OFF, otherwise, every time the unit is power-cycled the factory settings will take over.

Note

To enable the DHCP, besides using SW1 DIP switch #3, set the iServer's IP address to 0.0.0.0. An iServer with IP address of 0.0.0.0 will request an IP address, gateway address, and subnet mask from the DHCP server over the Ethernet.

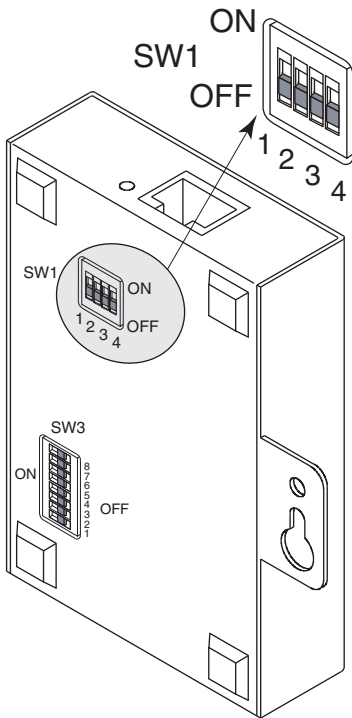

Figure 2.4a DIP Switch SW1
Wall Mount iServer

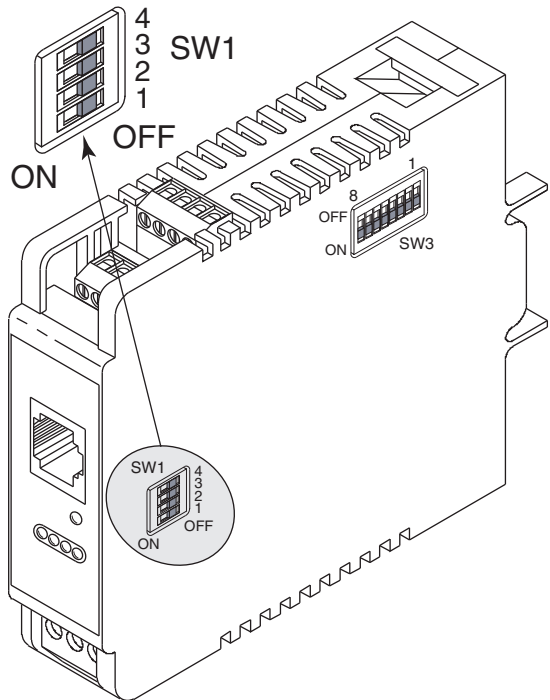

Figure 2.4b DIP Switch SW1
DIN Rail iServer

2.2.2 SW3 DIP Switch Usage

The iServer is shipped with all SW3 DIP switches in "OFF" position (signal 5V max).

SW #	DESCRIPTION	CHANNEL
1	PULL DOWN (1K ohm)	CHANNEL A
2	PULL UP (3K ohm)	CHANNEL A
3	PULL DOWN (1K ohm)	CHANNEL B
4	PULL UP (3K ohm)	CHANNEL B
5	HIGH INPUT SIGNAL (0-12 V)	CHANNEL B
6	LOW MAGNETIC SIGNAL (120 mV)	CHANNEL B
7	HIGH INPUT SIGNAL (0-12 V)	CHANNEL A
8	LOW MAGNETIC SIGNAL (120 mV)	CHANNEL A

Note

Refer to Specifications **Section 5** for SW3 jumper configurations.

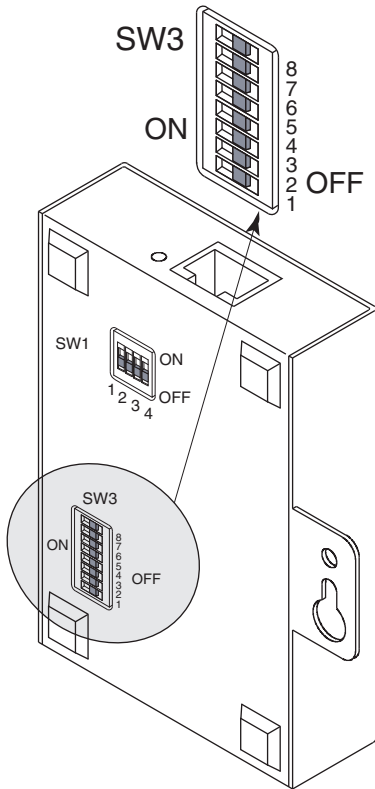

Figure 2.5a DIP Switch SW3
Wall Mount iServer

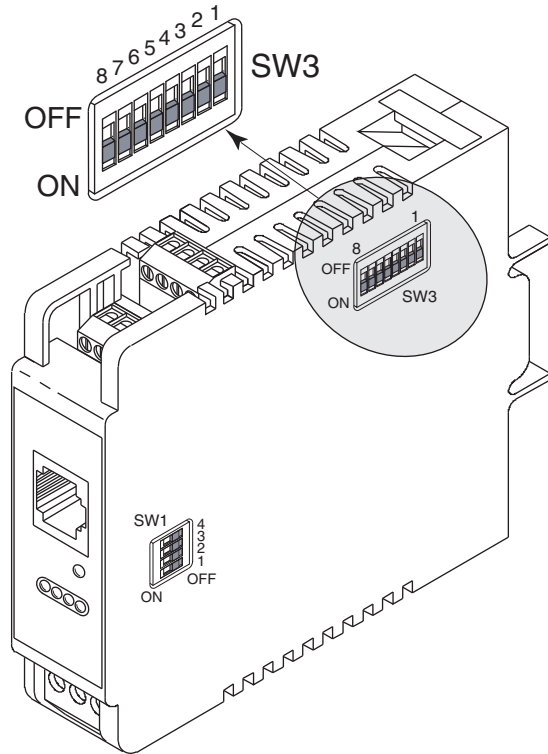

Figure 2.5b DIP Switch SW3
DIN Rail iServer

2.3 Parts of the iServer Unit

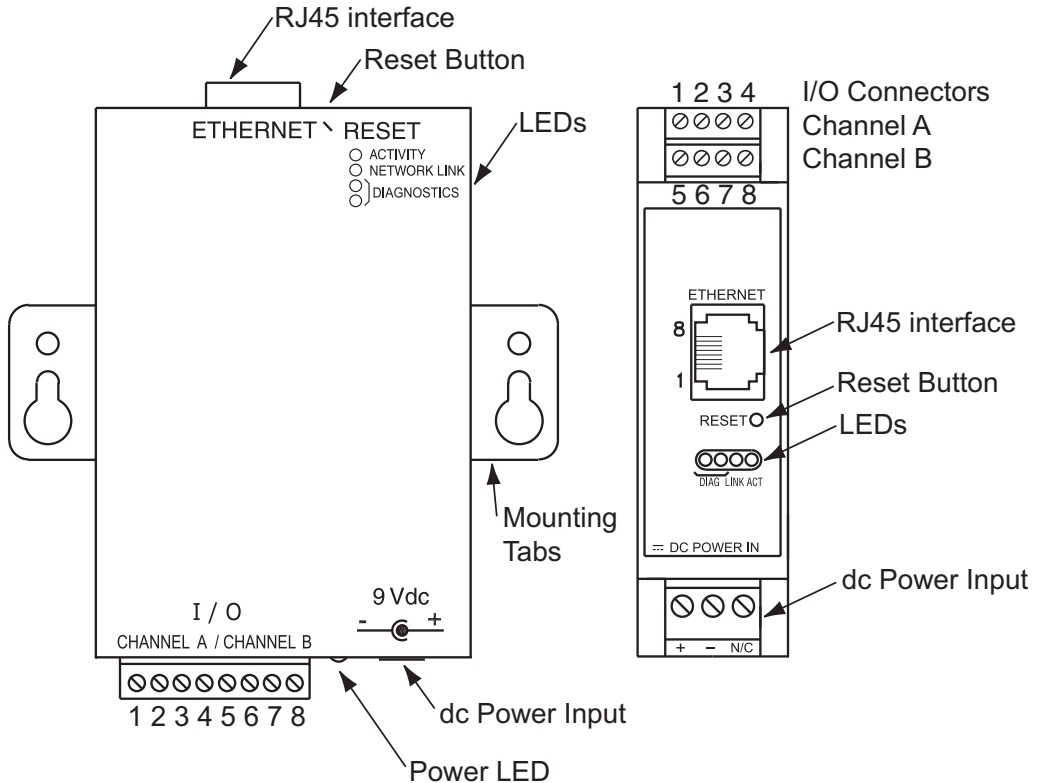

Figure 2.6 Parts of the iServer Unit

Table 2.1 Parts of iServer Unit

ETHERNET	RJ45 interface for 10BASE-T connection.
RESET	Button: Used for power resetting the iServer.
I/O	Connections for Channel A and Channel B, Refer to Section 2.4 .
ACTIVITY	LED (Red) Blinking: Indicates network activities (receiving or sending packets).
NET LINK	LED (Green) Solid: Indicates good network link.
DIAG	LED (Yellow and Green) Diagnostics: at boot-up they turn on for 2 seconds, then turn off; DHCP: if DHCP is enabled, they blink and stay solid periodically
POWER	LED (Green) Solid: Indicates Power-ON (for -W version only).
DC Power Supply Section:	
+	Plus power supply wire connection (inside the plug for -W version).
-	Minus power supply wire connection (outside the plug for -W version).

2.4 Wiring

Figure 2.7 shows the signals on the 8 Position Connector.

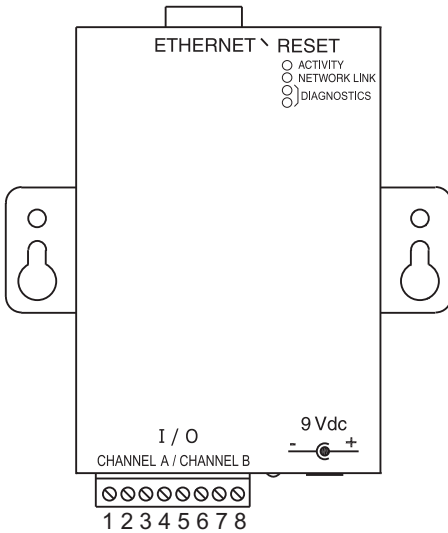

I/O CONN.	SIGNAL	CHANNEL
1	VCC	CHANNEL A
2	GND	CHANNEL A
3	OUT A	CHANNEL A
4	IN A	CHANNEL A
5	VCC	CHANNEL B
6	GND	CHANNEL B
7	OUT B	CHANNEL B
8	IN B	CHANNEL B

Figure 2.7a Wall Mount iServer 8 Position Connector

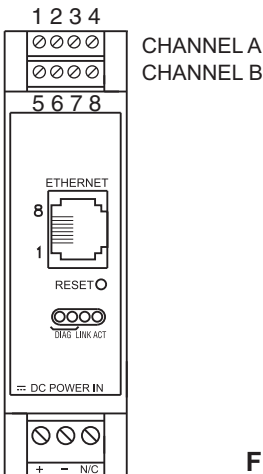

I/O CONN.	SIGNAL	CHANNEL
5	VCC	CHANNEL B
6	GND	CHANNEL B
7	OUT B	CHANNEL B
8	IN B	CHANNEL B
1	VCC	CHANNEL A
2	GND	CHANNEL A
3	OUT A	CHANNEL A
4	IN A	CHANNEL A

Figure 2.7b DIN Rail iServer 8 Position Connector

2.5 Network Communication Interfaces

2.5.1 10Base-T RJ-45 Pinout

The 10BASE-T Ethernet network (RJ-45) system is used in the iServer for network connectivity. The 10 Mbps twisted-pair Ethernet system operates over two pairs of wires. One pair is used for receiving data signals and the other pair is used for transmitting data signals. This means that four pins of the eight-pin connector are used.

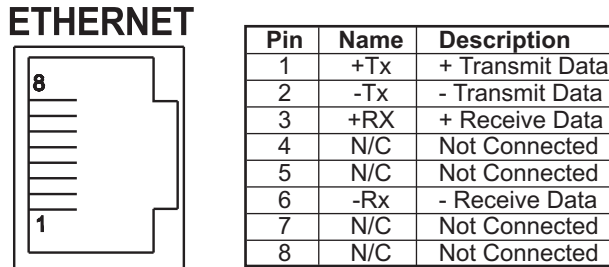

Figure 2.8 RJ45 Pinout

2.5.2 10Base-T Crossover Wiring

When connecting the iServer directly to the computer's network port, the transmit data pins of the computer should be wired to the receive data pins of the iServer, and vice versa. The 10Base-T crossover cable with pin connection assignments are shown below

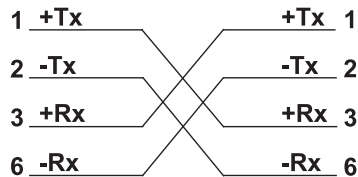

Figure 2.9 10Base-T Crossover Cable Wiring



Use straight through cable for connecting the iServer to an Ethernet hub. The ports on the hub are already crossed.

PART 3 NETWORK CONFIGURATION

3.1 Network Protocols

The iServer can be connected to the network using standard TCP/IP protocols. It also supports ARP, HTTP (WEB server), DHCP, DNS and Telnet protocols.

3.2 Ethernet (MAC) Address

MAC (Media Access Control) address is your computer's unique hardware number. When you're connected to the LAN from your computer, a correspondence table relates your IP address to your computer's physical (MAC) address. The MAC address can be found on a label attached to your device and contains 6 bytes (12 characters) of hexadecimal numbers XX:XX:XX:XX:XX:XX hex

For example: 0A:0C:3D:0B:0A:0B

Note Remove the small label with the default IP address and there will be room to put your IP address. See **Figure 3.1**

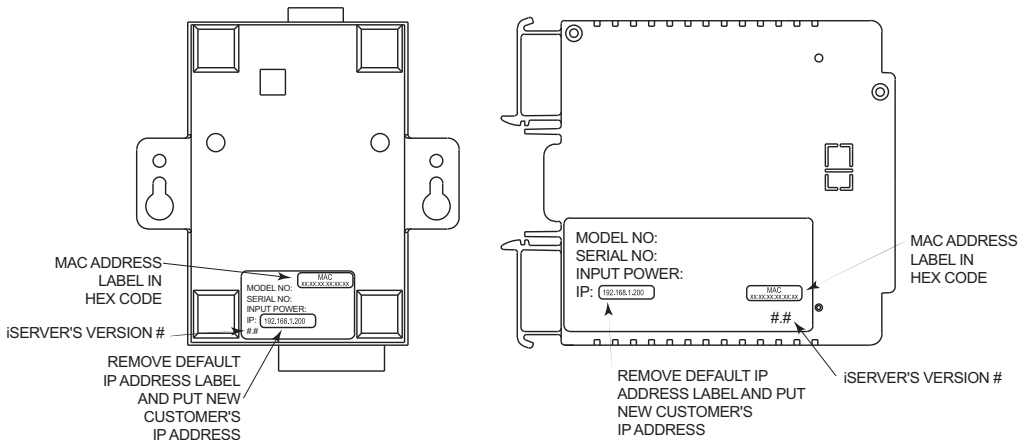

Figure 3.1 Labeling

3.3 DHCP

DHCP, Dynamic Host Configuration Protocol enables individual computers or devices to extract their IP configurations from a server (DHCP server). If the DHCP is enabled on your iServer, as soon as the iServer is connected to the network, there is an exchange of information between DHCP server and the iServer. During this process the IP address, the Gateway address, and the Subnet Mask will be assigned to the iServer by the DHCP server. Note that the DHCP server must be configured correctly to do such assignment.

If fixed or static IP address is desired, the DHCP must be disabled. The iServer is shipped with DHCP disabled (factory default). The DHCP can be enabled by setting the SW1 DIP switch # 3 to the “ON” position (refer to **Figure 3.2**).

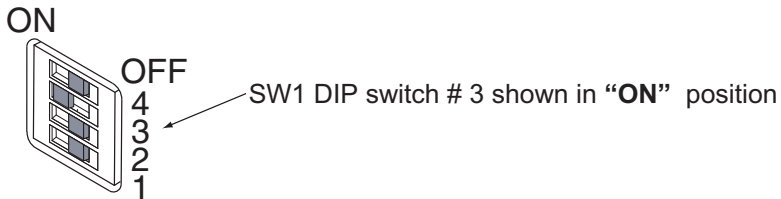

Figure 3.2 SW1 DIP Switch

3.4 DNS

DNS, Domain Name System enables individual computers and devices to be recognized over a network based on a specific name instead of an IP address. For example, instead of having to use **http://192.168.1.200** (IP address), you would use only **http://eis03ec** or any eight character name stored as Host Name under Access Control page in the iServer Home Page. The default DNS name for an iServer is "eis" followed by the last four digits of the MAC address of that particular iServer.

Note

1. It is very important to communicate with the network administrator in order to understand the DHCP and its existing configurations on the host server, before enabling the DHCP on the iServer.
2. The iServers are shipped with a default static IP address of **192.168.1.200** and Subnet Mask of **255.255.255.0**.
3. On Novell networks or Windows 2000 Server where the DHCP is an updated function of DNS, this feature may be beneficial since a particular name can be assigned eliminating the need for the IP address, as described in **Section 3.4**.

3.5 IP Address

Every active device connected to the TCP/IP network must have a unique IP address. This IP address is used to build a connection to the iServer. Every computer using TCP/IP should have a unique 32-bit address. It is divided into two portions, the network ID and the host ID. For instance, every computer on the same network uses the same network ID. At the same time, all of them have a different host ID. For more details about the IP address see **Appendix B**.

3.5.1 Default IP Address

The iServer is shipped with a default IP address set to **192.168.1.200** and Subnet Mask of **255.255.255.0**. If you are going to use a Web browser or Telnet program to access the iServer using its default IP address, make sure that the PC from which you're establishing the connection has an IP address that is in the same range as the iServer's IP address (**192.168.1.x**, where **x** can be any number from 1 to 254).

 **Note** Your PC's IP address cannot be the same as the iServer's IP address).

You also need to make sure that your PC's Subnet Mask is **255.255.255.0**. This is a good way to access the iServer over the network and make any configuration changes needed. If the factory default address is already in use on your network, use an Ethernet crossover cable between your computer and the iServer and modify the IP address or any other settings within the iServer.

3.6 Port Number

All TCP connections are defined by the IP address and a port number. A port number is an internal address that provides an interface between an application running on your computer and the network through the TCP/IP protocol.

There are three default TCP socket port numbers assigned to the iServer:

1. Port (socket) number 1000 when using HTTPGET program.
2. Port (socket) number 2000 when trying to access the device connected to the port of the iServer to receive signals.
3. Port (socket) number 2002 when trying to access the iServer itself for Power Recycling the iServer remotely. This can be done using Windows standard Telnet application. Refer to **Section 4.8** for more information.

PART 4

OPERATIONS

This iServer can be used and configured in several ways, depending on user's preference and network setup. It can be configured using a Web browser, like Netscape or Internet Explorer. It can also be configured using NEWPORT's iCONNECT Configuration Software. In addition to iServer operation, it can also be used in Telnet simulation mode where it emulates serial communication operation over a network cable. If DHCP and DNS servers are used, the connection is very simple, no need to find the right IP address or watch for network conflicts, these are done for you by your network DHCP and DNS server. All that is left for you to do, is to use a straight network cable to connect the iServer to a hub and power it up.

Tip Instead of connecting the iServer directly to your network, you can configure your PC's network connection with an IP address (**192.168.1.x**) that is in the same range as the iServer's default IP address (**192.168.1.200**) and connect to the iServer using a cross-over network cable between your PC's network port and the iServer.

Go to your computer that is connected to the same network and from the MS-DOS Prompt window type "**ping 192.168.1.200**" and press Enter. If DHCP and DNS servers are used type "**ping eisxxx**", where xxx are the last four digits of the iServer's MAC address, located on the device (see **Figure 3.1**). You should get a reply as shown in **Figure 4.1**.

4.0 Testing the Connection

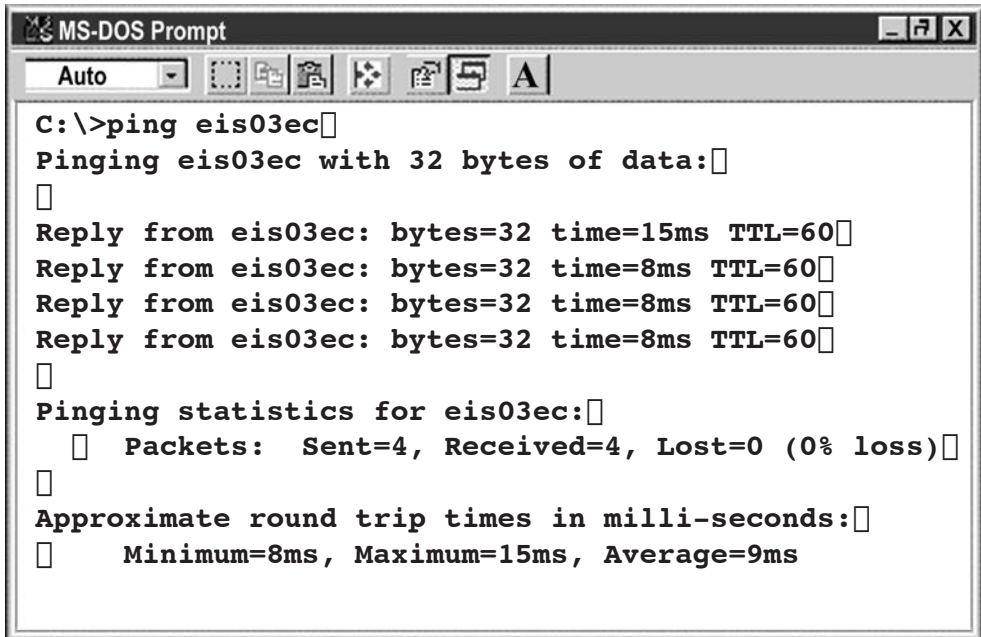

```
MS-DOS Prompt
Auto
C:\>ping eis03ec
Pinging eis03ec with 32 bytes of data:
 
Reply from eis03ec: bytes=32 time=15ms TTL=60
Reply from eis03ec: bytes=32 time=8ms TTL=60
Reply from eis03ec: bytes=32 time=8ms TTL=60
Reply from eis03ec: bytes=32 time=8ms TTL=60
 
Pinging statistics for eis03ec:
   Packets: Sent=4, Received=4, Lost=0 (0% loss)
 
Approximate round trip times in milli-seconds:
   Minimum=8ms, Maximum=15ms, Average=9ms
```

Figure 4.1 Pinging the iServer from MS-DOS Prompt

This proves that the connection is proper and you can get into configuration or run mode using the Telnet or Web browser.

4.1 iCONNECT Software

The iServer may also be assigned an IP Address by using the iCONNECT software.

- a) Download the iCONNECT software from the website listed in this manual.
- b) Install iCONNECT software on a networked PC. This software is compatible with Windows 95, NT, 2000, and XP.
- c) Use iCONNECT to assign an IP address to the iServer and access its web pages for configuration. You can also use any standard web browser to access the iServer's web pages. Consult with your IT department for obtaining an IP address.

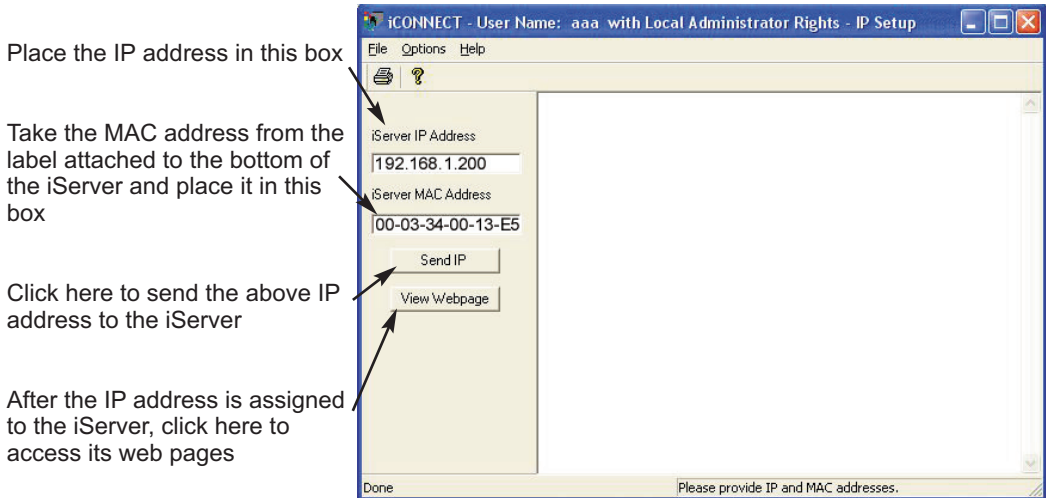

Figure 4.2 Assigning an IP Address using iCONNECT

- d) To access the iServer for Configuration:
Click on the "View Webpage" button, you will access the iServer's Home page, refer to **Section 4.3** for details.

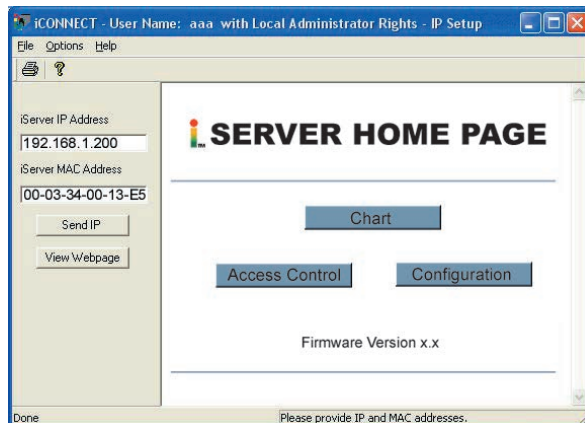

Figure 4.3 Accessing the iServer's Home Page

4.2 Setting a New IP Address over the Network

Besides using the iCONNECT software, you may use the iServer's default IP address to access it and assign a new IP address to it.

The iServer is shipped with a default IP address of **192.168.1.200** and Subnet Mask of **255.255.255.0**. You can configure your PC's Network connection with an IP address that is in the same range as the iServer's IP address (**192.168.1.x**) and connect to the iServer using a crossover network cable between your PC and the iServer.

With this completed, you can go to the DOS-Prompt and ping **192.168.1.200**. If you receive responses back (**Figure 4.1**), you can go to a Web browser and type in **http://192.168.1.200** and it will take you to the iServer's main web page.

Select Access Control button, you'll be asked for the password. The default Login password is "**12345678**" and the Admin password is "**00000000**", then you should be on the Access Control page where you can simply type in the desired Static IP address, and click Save.

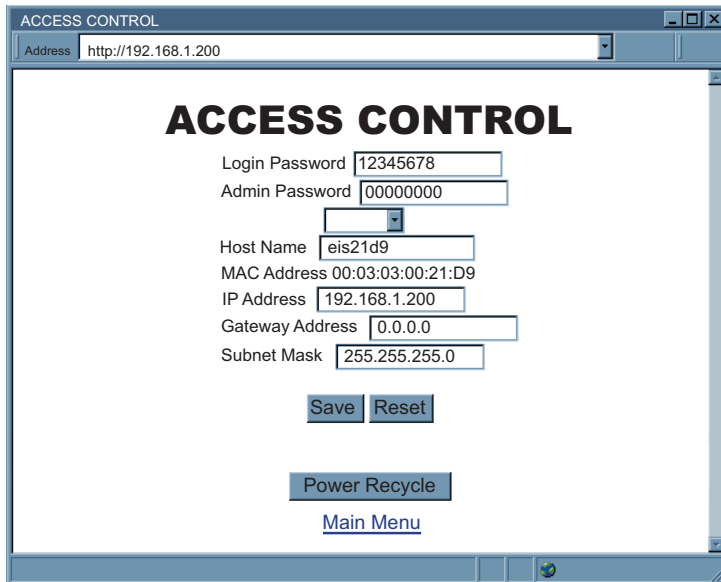

The screenshot shows a web browser window titled "ACCESS CONTROL" with the address bar set to "http://192.168.1.200". The main content area displays the "ACCESS CONTROL" page with the following fields and values:

- Login Password: 12345678
- Admin Password: 00000000
- Host Name: eis21d9
- MAC Address: 00:03:03:00:21:D9
- IP Address: 192.168.1.200
- Gateway Address: 0.0.0.0
- Subnet Mask: 255.255.255.0

Below the fields are buttons for "Save" and "Reset", a "Power Recycle" button, and a "Main Menu" link.

Figure 4.4 Access Control

For the IP address to take effect, the iServer needs to be turned OFF/ON or pressing the physical button marked "RESET" on the iServer

You can now connect the iServer to an Ethernet hub using a straight through cable, power it up, and follow the ping routine mentioned in the previous section.



Refer to **Section 4.12** for detailed descriptions and functions of the Access Control Page.

4.3 Setup and Operation Using a Web Browser

- Start your web browser.
- In the URL field, type **<http://eisxxxx>** using the last four-digits from the MAC address label located on the device (see **Figure 3.1**) if DHCP and DNS are used.
- If a static IP address is used, then simply type **<http://x.x.x.x>**, where **x.x.x.x** is the iServer's IP address.
- The Home Page will be displayed.

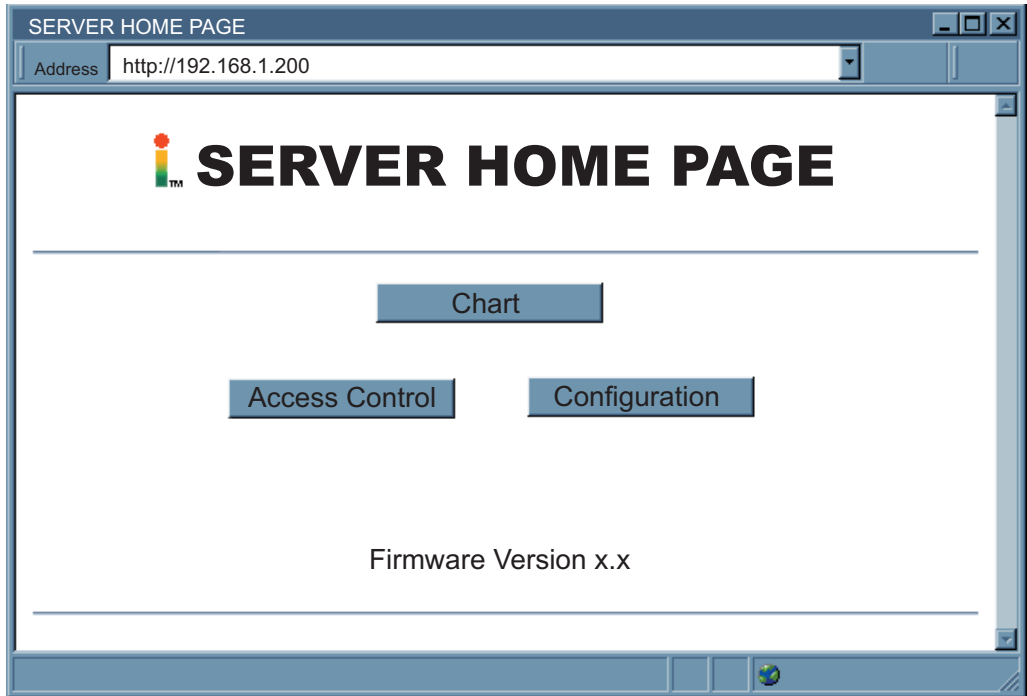

Figure 4.5 iServer Home Page Menu



If a blank screen appears without any “java application running” or image of a “Java logo”, please verify you have the latest Java Runtime Environment installed and setup according to the following instructions in **Section 4.5**. If you do not have Java Runtime Environment, you may download it from our website or contact the Customer Service Department nearest you.

4.4 Login

In order to access certain menu items of the Home Page, users may be prompted for a password, as shown in **Figure 4.6**.

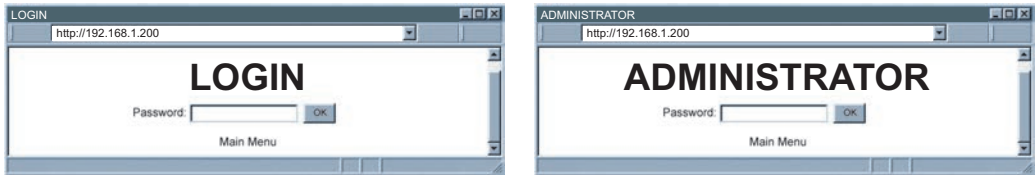

Figure 4.6 LOGIN and ADMINISTRATOR Passwords

There are 2 different access levels:

1. ADMINISTRATOR Password (administrator) allows certain groups and individual users to access and modify "entire" iServer parameters without any restrictions.
The default password is **00000000**. This password can be up to 16 alphanumeric case-sensitive characters.
2. LOGIN Password (operator) allows users to access and modify the iServer parameters except the "Access Control" which requires an Administrator password.
The default password is **12345678**. This password can be up to 16 alphanumeric case-sensitive characters.

4.5 Java Runtime Environment 1.7 Setup instructions

If your computer does not have Java installed, please download from java.sun.com. You can change the Java setting by clicking its icon in Control Panel. To load the applet, you have to enable the web browser and disable cache.

1. Go to your computer's Control Panel. Open the Java Plug-in

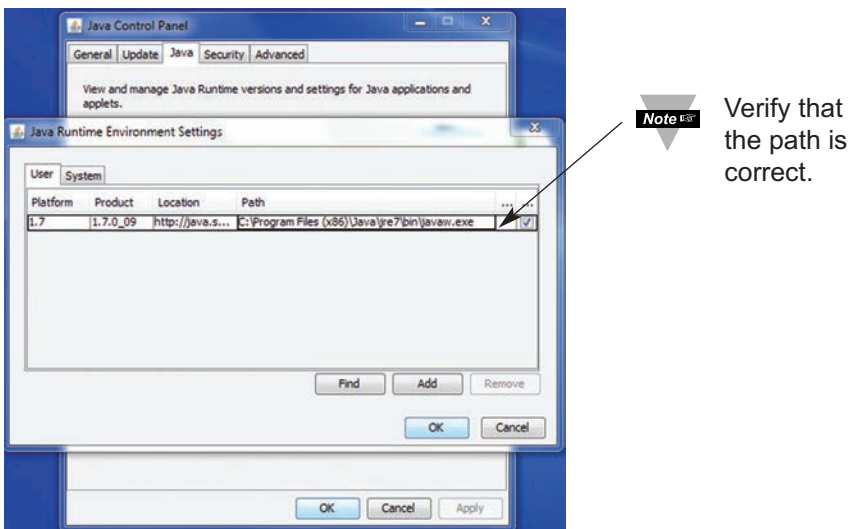

Figure 4.7 Java 1.7 Screen Shot

4.5.1 Browser Proxy Selection

Accessing iServer units within your internal network

- Usually when the computer and iServer are on an internal network, you will not use Proxy server access.
- You should un-check the "Use Browser Settings" option on the "Proxy" tab.

Accessing iServer units using the internet

- Often the web browser will use Proxy server access to the internet. In such cases, the default Java runtime settings on the "Proxy" tab should suffice. The default setting is the "Use Browser Settings" option.
- If the default proxy setting doesn't work, then you may have a situation where the proxy settings of the web browser are incorrect.

Diagnostics:

If the web page of the iServer appears, then the HTTP Proxy is working fine.

If the data isn't updated on the iServer upon selecting the Read Sensor web page, there may be a problem with access through a winsock proxy server. In such cases your network administrator will need to provide the winsock proxy server and port #s. (If the administrator requires knowledge of the port # required on the iServer, the value is 2003).

These values should be entered into the Socks line on the "Proxy" tab (of the Java Plugin control panel) or into the "connections" tab on the View,Internet Options dialog and make sure that the Proxy tab shows that the "Use Browser Settings" option is not selected (i.e. when you specify proxy connections in the Java Plugin control panel).

Accessing iServer units over Peer-to-Peer network

A simple peer-to-peer network is setup by disconnecting from the main network (as users will often do when trying to do initial setup of the iServer) and then connecting the iServer to another computer using an ethernet hub, an ethernet switch, or a Cross-over cable connection.

Often when using a peer-to-peer network, the Java plugin and the web browser (such as Internet Explorer) have internet connections configured to connect through proxy servers. In such case, you will need to simply assign the final IP address on this peer to peer network and then view the iServer charts after connecting the iServer into the regular network. Otherwise you can disable the Java plug-in's "Use Browser Settings" temporarily and then reconfigure the Java plug-in settings for regular network access after testing the iServer chart access on your peer-to-peer network.

The "Use Browser Settings" should not be selected. And the HTTP and Socks proxy entries should be blank. Also, setup the internet browser so that proxy servers are disabled.

Java and the Java Coffee Cup Logo are trademarks or registered trademarks of Sun Microsystems, Inc. in the U.S. and other countries."

Note

If you still have problems viewing the page and you are on a Proxy Server or are behind a Firewall, please contact your MIS administrator to verify that you have the latest Proxy Client Software, version 2.0 or higher.

4.6 iServer Operation Basic Menus

4.6.1 Chart Descriptions

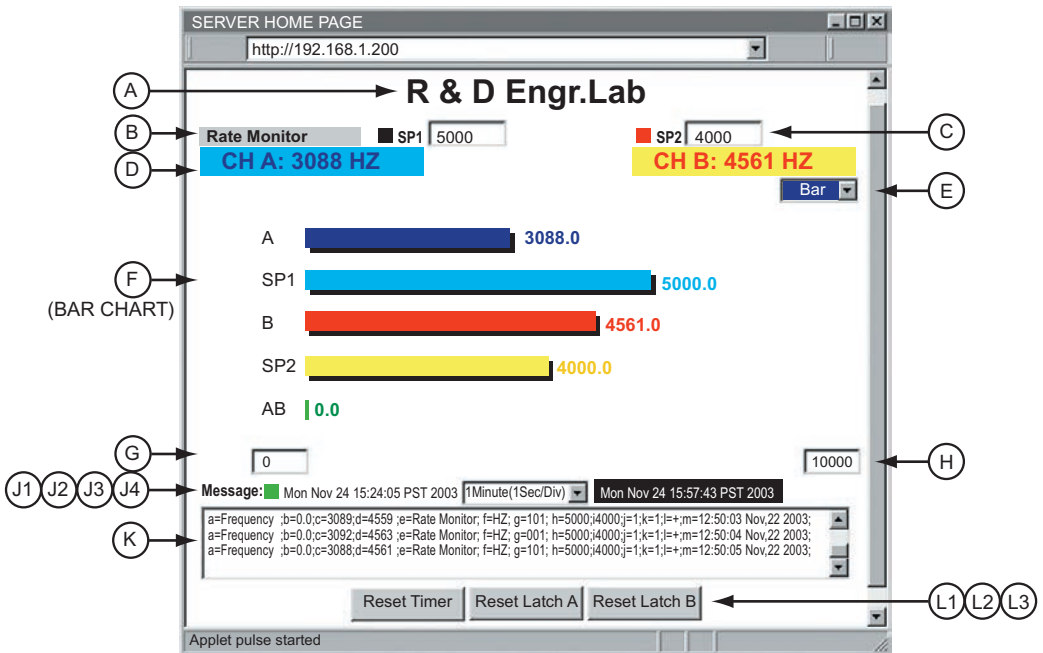

Figure 4.8 Chart Descriptions

- A) Chart's *Title* name decided by the user.
- B) Experiment/Task's *Name* decided by the user.

Tip Refer to **Section 4.7** Device/Configuration Page's Descriptions and Setup for editing the Chart's *Title* and Experiment/Task's *Name*.

- C) *Alarm Setpoint 1* or *Alarm Setpoint 2* setup. Type in the desired values and hit enter key, the square shape dot symbolizes the Alarm Status Indicator, which is normally Black and will turn Red if the alarm is activated.
- D) *Digital Display* of Dual Input channels, it can display in any engineering units required. Blue for CH A in cyan color background and red for CH B in yellow color background. In this example, it is the reading of frequencies of 2 Signal Generators.

Tip To display your own-defined Unit, Refer to **Section 4.7** Device/Configuration Page's Descriptions and Setup for editing and modification.

4.6.1 Chart Descriptions (continued)

- E) *Chart* Option Pull-Down Menu, which allows users to select *Bar* chart type **Figure 4.8** or *Line* chart type **Figure 4.9**.
- F) Graphical Display of Chart, either *Bar* or X-axis *Line Chart*.
- G) Enter your setting for *Minimum Range* of Measurement for graphical display.
- H) Enter your setting for *Maximum Range* of Measurement for graphical display.

 Those two settings will reset to default (100 max. and 0 min.) if there is any change made from Configuration or Chart refresh. To modify, just type in the desired values and simply hit enter key.

- J1) The *square dot* will flash between 2 colors red & green as representing a Network Communication Activity Indicator as device successfully connecting otherwise remaining red if there is problem with connection or Network disconnected.
- J2) *Start Date* and *Time* of the Experiment / Measurement Task.
- J3) *X-Axis Time Scale* Option Pull-Down Menu for Line Chart. There are 6 options available to users as the following:
 - 1 Minute (1 Second/Div)
 - 1 Hour (1 Minute/Div)
 - 1 Day (1 Hour/Div)
 - 1 Week (1 Day/Div)
 - 1 Month (1 Day/Div)
 - 1 Year (1 Month/Div).
- J4) *Current Date* and *Time* of the Experiment/Measurement Task. It is synchronized with users' operating system.

 Any modification or change that is made and saved from Configuration Page will restart the Chart.

4.6.1 Chart Descriptions (continued)

K) *Message Window* is described below.

Table 4.1 Message Item Window Description

Message: Content Description:	
Item:	Function
a	Device Measurement Mode/Type
b	CH A & CH B Combined input reading (A-B F or A-B T mode)
c	CH A input reading value
d	CH B input reading value
e	Your own-defined Name of Experiment/Measurement Task
f	Unit of Input Value (definable)
g	= 3 bits: 1st bit: the transmit active bit 2nd bit: the SP1 active bit 3rd bit: the SP2 active bit
h	SP1 (setpoint 1) value (A Batch value if Batch mode used)
i	SP2 (setpoint 2) value (B Batch value if Batch mode used)
j	Batch A Number (Number of A Batches)
k	Batch B Number (Number of B Batches)
l	A-B mode sign. (+, -, x and /)
m	User-definable time/date stamp of Input Reading. This time/date stamp will reset to default if the device's power was recycled.



These *Message Item Windows* will restart with new data after 10 lines of data.

- L1) Click this button to restart or to revert the measurement to specific number or a device condition to a specific state such as Zero or SetPoint.
- L2) Click this button to reset Alarm SetPoint Latched condition of Channel A.
- L3) Click this button to reset Alarm SetPoint Latched condition of Channel B.



In order to be able to using those above Reset Functions' buttons, users will be prompted at Login page for password once.

4.7 Device Configuration Page Items' Description and Concepts of Setup:

From the Home Page click on **CONFIGURATION** button to get to the Configuration/Device Setup page (see **Figure 4.9**). Users will be prompted with a Login Page to enter a password, default password is **12345678** and then click OK.

There are five types of settings in the Configuration Page, which should be saved by the reserved Save Button:

- Device Type / Operation Mode Selection.
- SetPoint / Alarm Operation.
- Title Definability Utility
- Operation Condition Parameters.
- Terminal / Remote (Tunneling) Setup.

The screenshot shows a web browser window titled "CONFIGURATION" with the address bar displaying "http://192.168.1.200". The main content area is titled "R & D Engr.Lab". At the top, there is a "Device Type Selection" section with a dropdown menu set to "Frequency" and a "Save" button. Below this, the page is divided into two columns of settings. The left column contains two sets of SetPoint (SP) parameters: SP1 and SP2. Each set includes a value field (e.g., "5.00000000e+03"), a Latch Mode dropdown (set to "Unlatch"), an Active Mode dropdown (set to "Above"), a Dead Band field (set to "0"), and an Active Status dropdown (set to "High"). Below these are TCP/UDP settings: a dropdown set to "TCP", a Server Type dropdown set to "Continuous", a Number of Connections field set to "5", a Port field set to "2000", a Remote Access dropdown set to "disable", a Remote Port field set to "2000", and a Remote IP Address field set to "0.0.0.0". The right column contains A and B scale parameters: A Scale (1.00000000E-00), A Offset (0), A Gate Time (0), A Debounce Time (0), B Scale (1.00000000E-00), B Offset (0), B Gate Time (1000), and B Debounce Time (0). At the bottom of each column is a "Save" button. The "Reading Format" is set to "Decimal" and "Number of Digits" is set to "9". The "Decimal Point" is set to "0" and "A-B Mode" is set to "+". The "Counter Mode" is set to "Count UP".

Figure 4.9 Configuration/Device Setup

4.7.1 Device Type/Mode Selection:

This is one of the first choice that users must decide and choose to operate device for the requirement of applications. Using your Web Browser, users can configure this device to operate either with universal single or dual input channels in following available modes as Device Type Selection Pull-Down Menu illustrated:

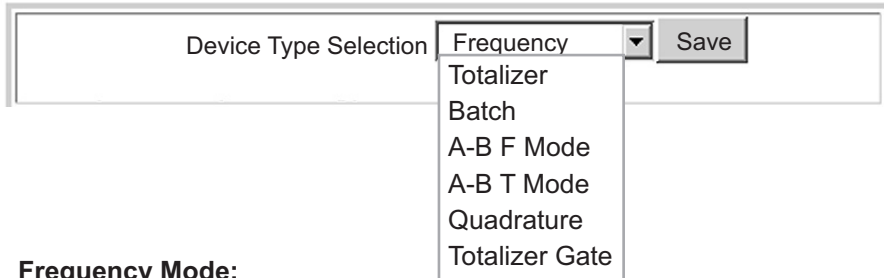

4.7.1.1 Frequency Mode:

This mode (factory default) configures the iServer to operate as a single or dual input frequency counter, range 1 to 100 KHz, or dual rate meter that counts per unit time.

The iServer displays the units of measurement of 2 input signal sources as CH A and CH B in Blue or Red respectively. The chart allows user-definable engineering units.

Both Line or Bar chart Option are available.

Users can monitor the values in 6 different time scales available from 1 min. to 1 year history of experiment time duration.

Use scale to convert input frequency unit to units other than Hertz (Hz) as definable by users and suitable for any application requirement.

For Frequency Mode ID, observe *Message Item Window* and notice items following:

a= Frequency

c=CH A input pulse/frequency reading value

d=CH B input pulse/frequency reading value

Note  Make certain that Debounce Time must be zero to operate in this Frequency mode.

Note  Set jumper for selecting low-level input if the reading is not displayed.

Note  Refer to Specifications **Section 5** for SW3 jumper configurations.

4.7.1.2 Totalizer Mode

This mode is operated commonly as event counter or recorder as either with single A or B channel or If there are dual inputs, both Input values will be totalized or accumulated and displayed graphically and digitally until Reset Timer Button restart measurement of both Channels at zero or the Offset values.

However Users must readjust Max. or Min. Range Values between measurement values to keep Line Chart fully displaying as once reset executed. Device now is UP & DOWN 32-bit Counter ranging between (-2147483647 and +2147483647). Users must access Configuration Page to setup device for this mode.

For Totalizer Mode ID, observe *Message Item Window* and notice items following:

a= Totalizer

c=CH A input count reading value is totalizing: CH A Total count

d=CH B input count reading value is totalizing: CH B Total count

For Example: To compare and monitor PCB (Printed Circuit Board) Assembling Productivities of 2 machines or 2 types of product with specified time period by selecting suitable x- Axis Time Scale Option according to your company's demand, **Figure 4.10** is one of example, this device offers the most typical and user-friendly illustration and clarity as setup with this Totalizer Mode.



Note Make certain that Debounce Time must be zero when operating with frequency signals.

4.7.1.2 Totalizer Mode (continued)

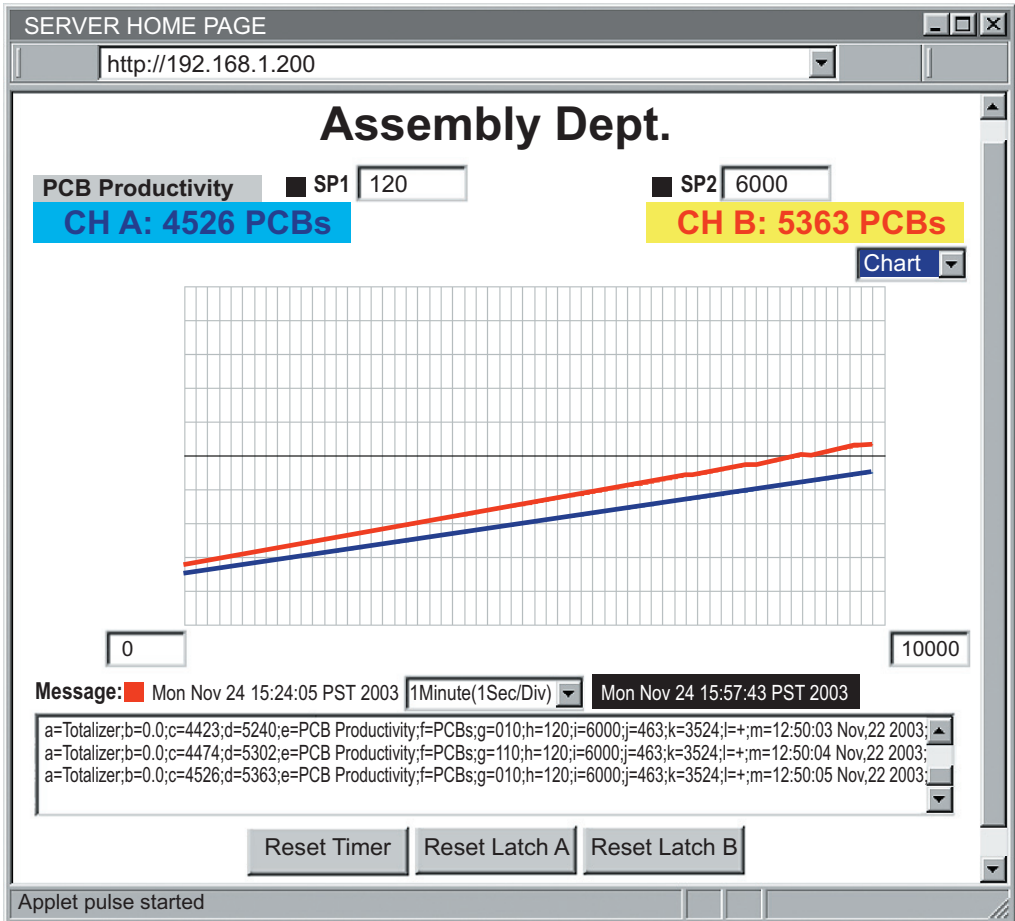

Figure 4.10 Example of Totalizer Mode

4.7.1.3 Batch Mode

This mode is for either single or dual input counting and monitoring visually number of definable batches that is required by users' application. To setup Batch value (unit count) and Batch mode, users must access Configuration Page for detail of setting descriptive parameters. However users should notice the following important items on Chart:

SP1 must be also understood as actual A Batch (unit count) value.

SP2 must be also understood as actual B Batch (unit count) value.

Batch A must be understood as Number of Batches counted via CH A.

Batch B must be understood as Number of Batches counted via CH B.

For Example: Machine A requires oil drop lubrication every 3199 PCB's produced then there must be done 89 times for 1 hour and Machine B requires a soft-reset every 12000 PCB's produced then there must be done 28 times for 1 hour as **Figure 4.11** illustrates. If Time Scale Option of *1 Minute (1 Sec/Div.)* is selected, Users can monitor process, tracking time and be prepared for the required tasks in precise timely manner.

With the Example:

h=Machine A maintenance requirement: A Batch (unit count) value= 3199 PCB's

i=Machine B system requirement: B Batch (unit count) value= 12000 PCB's

j= Number of Batches (or lubrication) counted via CH A input= 89 times

k= Number of Batches (or soft-reset) counted via CH B input= 28 times



Note Make certain that Debounce Time must be zero when operating with frequency signals.

4.7.1.3 Batch Mode (continued)

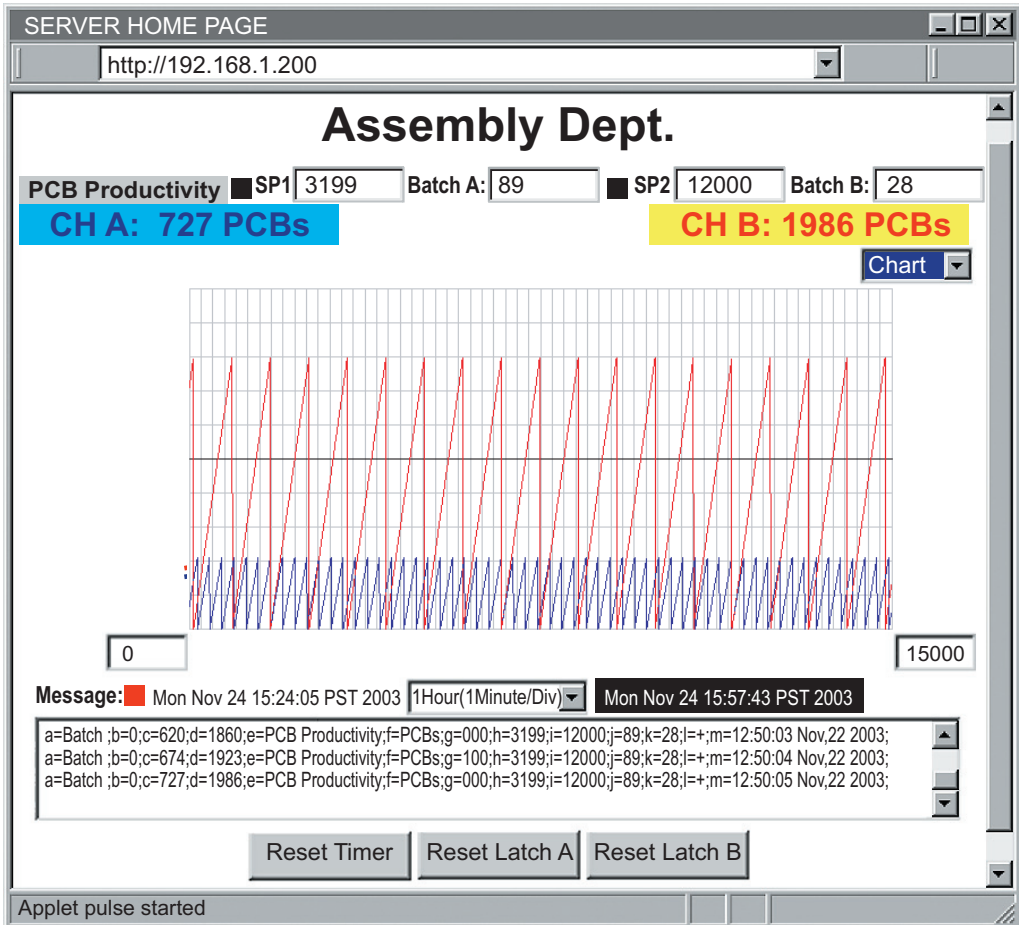

Figure 4.11 Example of Batch Mode

For Batch Mode ID, observe *Message Item Window* and notice items following:

a= Batch

c=CH A input count reading is totalizing and restart as Batch A value reached/passed

d=CH B input count reading is totalizing and restart as Batch B value reached/passed

h=CH A Batch (unit count) value

i=CH B Batch (unit count) value

j= Number of Batches counted via CH A input

k= Number of Batches counted via CH B input

4.7.1.4 A-B F Mode

This mode is designed to operate with dual input pulse rate or frequency sources. Its main function is to perform 4 common types of calculation (addition, subtraction, multiplication and division) of 2 input values at a specific time and display the result digitally as well as graphically with 2 types of chart, 6 types of time scale.

Users must access Configuration Page for setting this device operate under this mode, first select option A-B F Mode from Device Type Selection (Operation Mode) Pull-Down Menu then choose your type of Calculation:

- + : addition will calculate the sum of A+B
- : subtraction will calculate the difference of A-B
- x : multiplication will calculate the product of A.B
- / : division will calculate the ratio of A/B.

From A-B Mode (Calculation Type) Pull-down submenu.

Chart of this A-B F Mode will have additional combined (calculation results of A&B) A-B channels Value displayed digitally and graphically as a chart as illustrated in **Figure 4.12**. This example displays the results of Dual Counts A and B with PCB's is unit of counting.

- A-B: 200.6 PCB's is the subtraction of (CH A: 257 PCB's – CH B: 56.4 PCB's) in Green Color and Purple Color background.
- Third green line of Graph (between the top/blue of CH A and the bottom/red of CH B) is representing the subtracted values of A-B on *1Hr/Div. Time Scale*.
- Values of CH A and CH B are constant therefore the chart only shows all 3 straight lines.



Note Make certain that Debounce Time must be zero when operating with frequency signals.

4.7.1.4 A-B F Mode (continued)

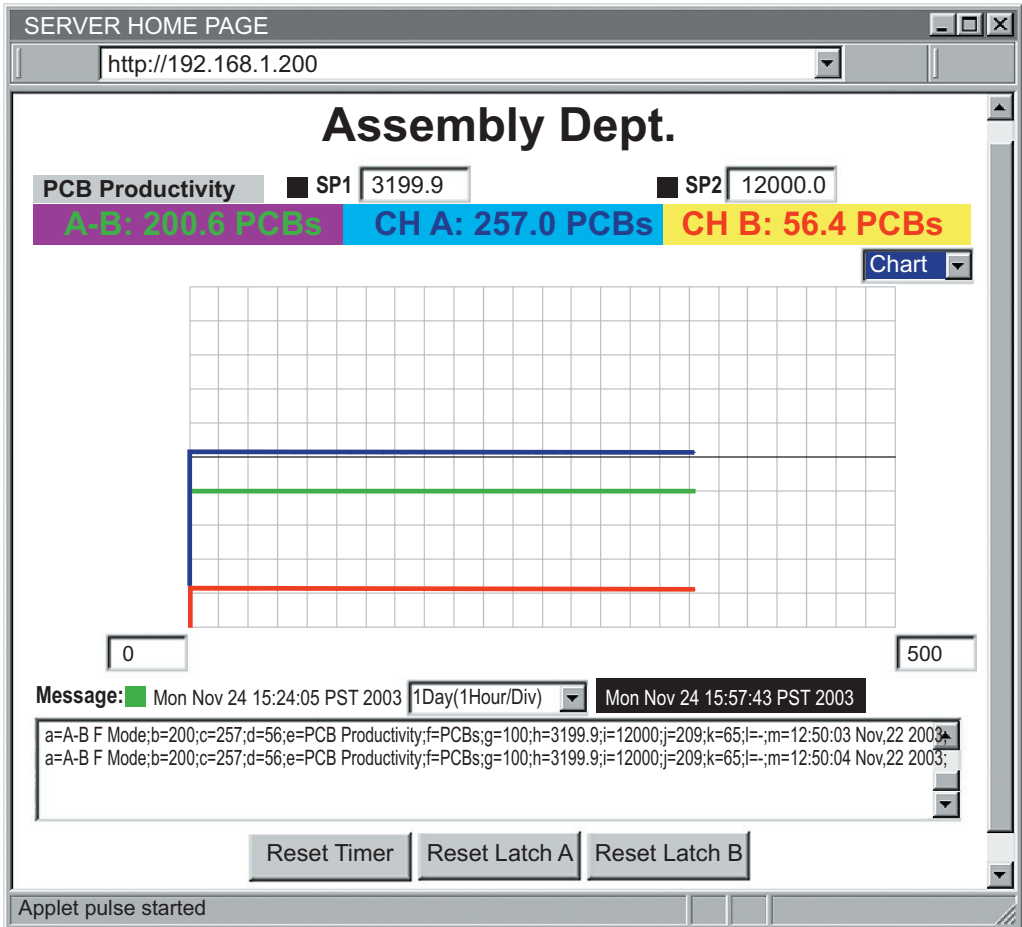

Figure 4.12 Example of A-B F Mode

For A-B F Mode ID, observe *Message Item Window* and notice items following:

- a= A-B F Mode
- b= combined (calculated results of A&B) input reading value.
- c=CH A input value
- d=CH B input value
- j= not applied (previous Number of Batch Mode Measurement)
- k= not applied (previous Number of Batch Mode Measurement)

4.7.1.5 A-B T Mode

This mode has almost the same setup procedure and operation as A-B F mode required. However Dual input channels will be totalized and additional A-B T combined input calculated values would change significantly except if A-B Mode pull-down Menu is selected with “ / ” option (division calculation) as observed from the example in **Figure 4.13** as A/B value always remained value of 3 PCB's while the others are changing rapidly.

Users must access Configuration Page for setting this device operate under this mode, first select option A-B T Mode from Device Type Selection (Operation Mode) Pull-Down Menu then choose your type of Calculation:

- + : addition will calculate the sum of A+B
- : subtraction will calculate the difference of A-B
- x : multiplication will calculate the product of A.B
- / : division will calculate the ratio of A/B.

From A-B Mode (Calculation Type) Pull-down submenu.

For A-B T Mode ID, observe *Message Item Window* and notice items following:

- a= A-B T Mode
- b= combined (calculated results of A&B) input reading value.
- c=CH A input count value is totalizing until users manually reset
- d=CH B input count value is totalizing until users manually reset
- j= not applied (previous Number of Batch Mode Measurement)
- k= not applied (previous Number of Batch Mode Measurement)

 **Note**

Make certain that Debounce Time must be zero when operating with frequency signals.

4.7.1.5 A-B T Mode (continued)

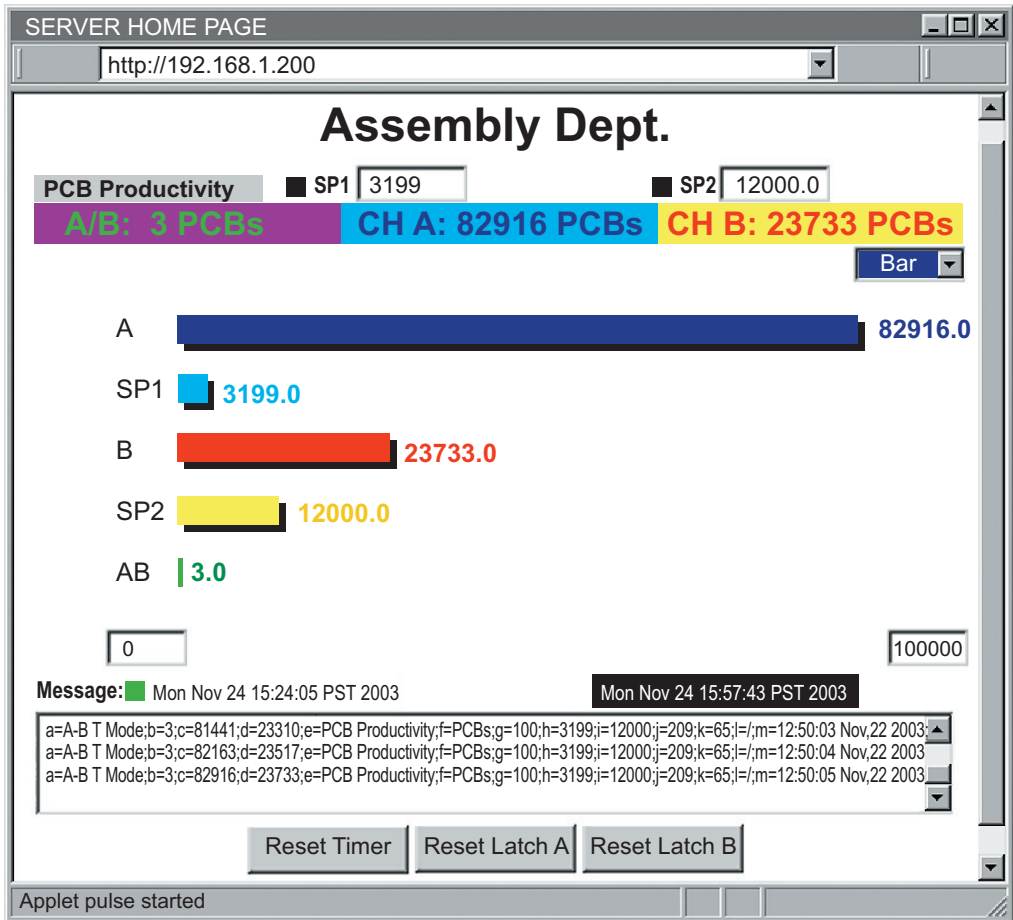

Figure 4.13 Example of A-B T Mode with Bar Chart

Users may constantly modify the Max or Min Range of Input Scale to accommodate with the growing rapidly of totalized input values for proper and fully displayed chart.

4.7.1.6 Quadrature Mode

This mode configures device to operate with two 90° phase shifted input signals A and B from linear or rotational revolvers. The counting direction of Channel A is automatically derived from the phase of the signals A and B that is designed for very fast, high-pulse rate totalizing measuring and positioning applications and to utilize the outputs of Rotary Pulse Generators (RPG's), Tachometers, Motion Monitors and Controls Devices or Equipments.

If Channel B input is disconnected its displayed Value will be the value of input signal of Channel A and device is counting and displaying Channel A input signal as totalized values on Channel A section of Chart.

For proper connection and configuration:

- Connect the main counting OUTPUT of RPG's to channel A and the Quadrature OUTPUT of most RPG's to Channel B.
- Access Configuration Page and Select Quadrature option from Device Type Selection (Operation Mode) Pull-Down Menu.

For Quadrature Mode ID, observe *Message Item Window* and notice items following:

a= Quadrature Mode

c=CH A input count value is totalizing until users manually reset

d=CH B input count value is Quadrature Signal or is actually Channel A input frequency or rate with phase shifted normally 90° if Channel B input disconnected

j= not applied (previous Number of Batch Mode Measurement)

k= not applied (previous Number of Batch Mode Measurement)



Note Make certain that Debounce Time must be zero when operating with frequency signals.

4.7.1.6 Quadrature Mode (continued)

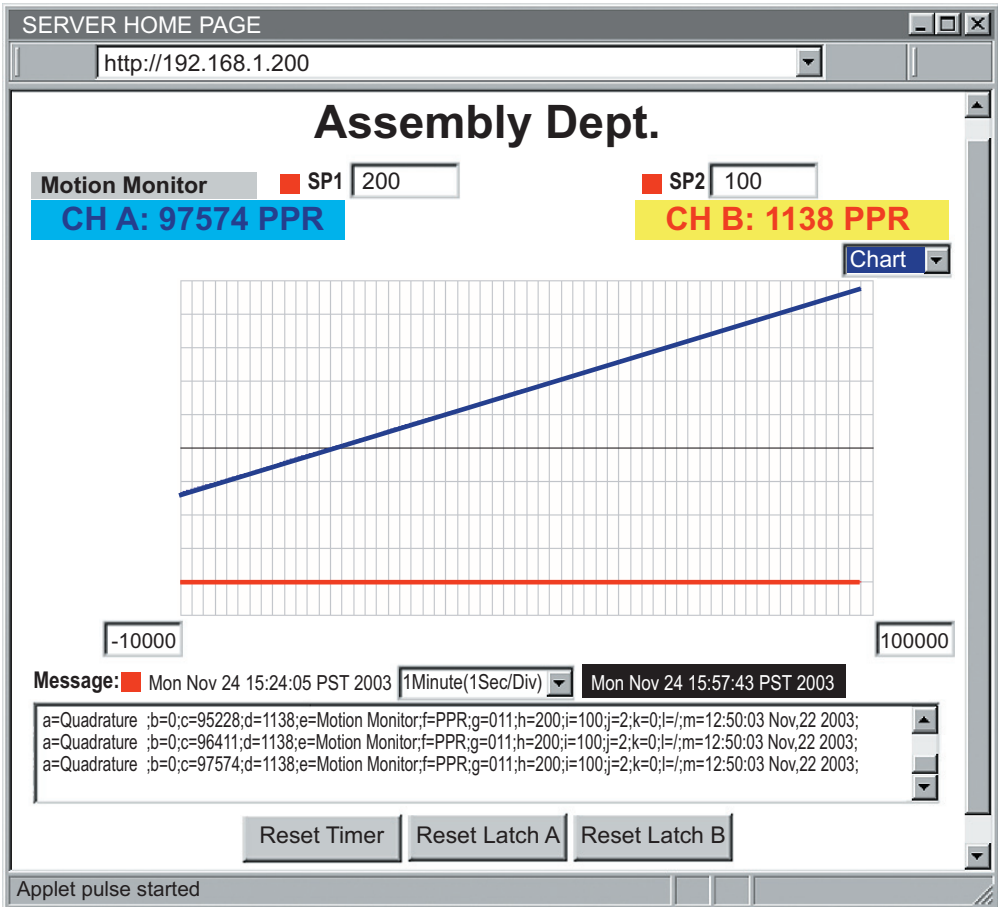

Figure 4.14 Example of Quadrature Mode

4.7.1.7 Totalizer Gate Mode

This mode offers total control to users with the uses of Channel A to Controlling and triggering signal to start, pause or restart the counting of totalizing Channel B input value which is served as the main input for measurement. Users can manually control by just creating an on-off toggle switch at the input terminal of channel A.

- Channel B starts counting / totalizing or pausing as soon as Channel A input signal is rising that works similarly to a function of a toggle switch.
- Device initially requires a toggle signal from Channel A input to start counting/totalizing from Zero or Offset value of Channel B.
- Reset Timer Button will stop the counting of Channel B measurement and reset it to Zero or Offset value.
- Chart displays only Channel B.

For proper connection and configuration:

- Connect the main counting INPUT source for measurement to channel B input terminal and the Totalizer Gate Input signal source for Controlling / Triggering Channel B counting / totalizing operation.
- Access Configuration Page and Select Quadrature option from Device Type Selection (Operation Mode) Pull-Down Menu.

For Quadrature Mode ID, observe *Message Item Window* and notice items following:

a= Totalizer Gate Mode

c=CH A input count value is totalizing until users manually reset

d=CH B input count value is Quadrature Signal or is actually Channel A input frequency or rate with phase shifted normally 90° if Channel B input disconnected.

Note 

Make certain that Debounce Time must be zero when operating with frequency signals.

4.7.1.7 Totalizer Gate Mode (continued)

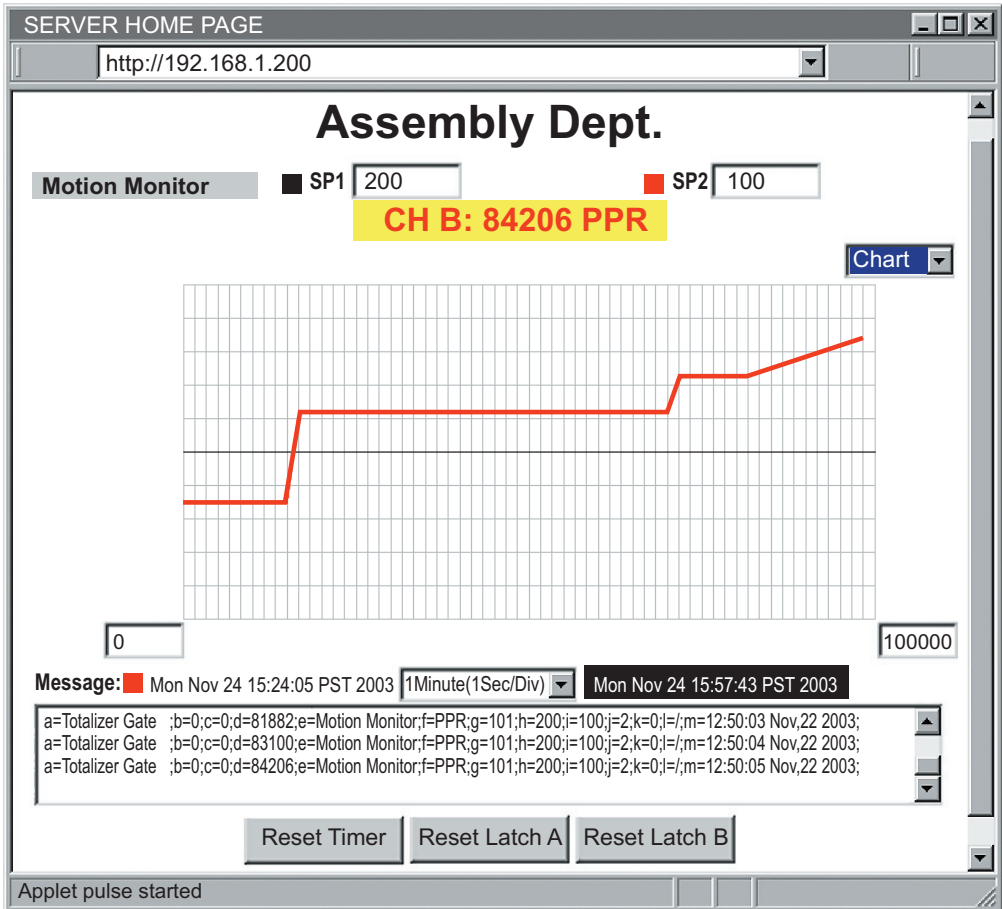

Figure 4.15 Example of Totalizer Gate Mode

4.7.2 SetPoint, Alarm and Alarm Output Operation Configuration

To setup Alarm1 / Alarm2 operations or Batches' values and access Configuration Page. Locate the section as illustrated in **Figure 4.16**:

The screenshot shows a configuration window with the following fields and values:

- SP1 Value: 5.00000000e+03
- SP1 Latch Mode: Unlatch
- SP1 Active Mode: Above
- SP1 Dead Band: 0
- SP1 Active Status: High
- SP2 Value: 4.00000000E+03
- SP2 Latch Mode: Unlatch
- SP2 Active Mode: Above
- SP2 Dead Band: 0
- SP2 Active Status: High

A "Save" button is located at the bottom center of the configuration area.

Figure 4.16 Example of SetPoint / Alarm Configuration Section



Any edited/modified value with decimal point must be matched with existing Decimal Point setting in Operation Condition Parameters **Section 4.7.4.1.11** of Configuration Page.

4.7.2.1 SP1 Value

Enter desired value for Alarm1 Setpoint or A Batch and its factory default value is 0. Whatever number is entered for modifying The SP1 Value or A Batch will be displayed in exponential format after SAVE button is pressed or clicked.

4.7.2.2 SP1 Latch Mode

Select either "Unlatch" (as default option) for unlatched Alarm1 operation or "Latch" for latched Alarm1 operation.

4.7.2.3 SP1 Active Mode

Set device alarm activation Above (as default option) or Below SetPoint 1 value.

4.7.2.4 SP1 Dead Band

Enter desired value of Alarm1 Dead Band.

4.7.2.5 SP1 Active Status

Select the logic normal-state of Alarm1 Output and its factory default value is High.

4.7.2.6 SP2 Value

Enter desired value for Alarm2 Setpoint or B Batch and its factory default value is 0. Whatever number is entered for modifying The SP2 Value or B Batch will be displayed in exponential format after SAVE button is pressed or clicked.

4.7.2.7 SP2 Latch Mode

Select either “Unlatch” (as default option) for unlatched Alarm2 operation or “Latch” for latched Alarm2 operation.

4.7.2.8 SP2 Active Mode

Set device alarm activation Above (as default option) or Below SetPoint 2 value.

4.7.2.9 SP2 Dead Band

Enter desired value of Alarm2 Dead Band.

4.7.2.10 SP2 Active Status

Select the logic normal-state of Alarm2 Output and its factory default value is High. For Alarm Status Monitoring or indicators, refer to Chart’s Items Description.

Note Any above settings must be saved for taking effect by its designated SAVE button, which is localized in this section, before returning to Chart.

4.7.3 Title Definability Utility

This section of Configuration Page allows users define or name the desired Name of Task/Experiment, Unit of Measure of application and Title of Chart and the space limits as following:

Name: has max.16 characters

Unit of Measure: has max.16 characters

Title: has max.16 characters

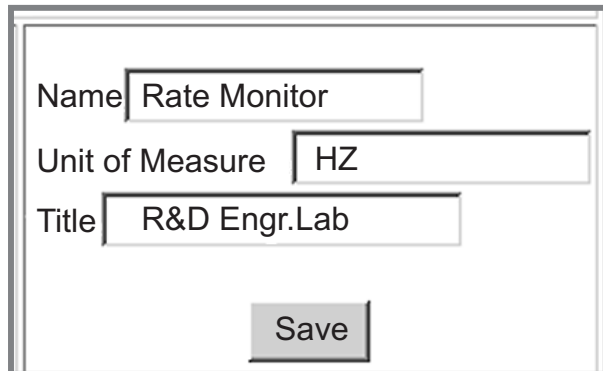

The screenshot shows a configuration window with three text input fields and a Save button. The first field is labeled 'Name' and contains the text 'Rate Monitor'. The second field is labeled 'Unit of Measure' and contains the text 'HZ'. The third field is labeled 'Title' and contains the text 'R&D Engr.Lab'. The Save button is located at the bottom center of the window.

Figure 4.17 Example of Title Definability Utility Section

Note Any above settings must be saved for taking effect by its designated SAVE button which is localized in this section before returning to Chart.

4.7.4 Operation Condition Parameters

This section of Configuration Page allows users to setup:

Input Reading Scale & Offset

Reading configuration: Gate time, Debounce time, Reading Format, Number of Digit and Decimal Point.

Counting Mode: Direction and A-B Channel combined modes.

A Scale

A Offset

A Gate Time (mS)

A Debounce Time (mS)

B Scale

B Offset

B Gate Time (mS)

B Debounce Time (mS)

Reading Format

Number of Digits

Decimal Point

A-B Mode

Counter Mode

Figure 4.18 Example of Operation Condition Parameters Section



Failure of proper configuration will result in misled measurement data or no data displayed.

4.7.4.1 Input Reading Scale & Offset

Users can setup dual channel reading Scale and Offset as described following:



Any edited/modified value with decimal point must be matched with existing Decimal Point setting in Operation Condition Parameters **Section 4.7.4.1.11** of Configuration Page.

4.7.4.1.1 A Scale:

Choose and setup up Channel A input reading displayed in different scale. Whatever number is entered for modifying The A Scale value will be displayed in exponential format after SAVE button is pressed or clicked.

4.7.4.1.2 A Offset:

Choose and setup up Channel A input counting value start in different point than zero.

4.7.4.1.3 B Scale:

Choose and setup up Channel B input reading displayed in different scale. Whatever number is entered for modifying The B Scale value will be displayed in exponential format after SAVE button is press or clicked.

4.7.4.1.4 B Offset:

Choose and setup up Channel B input counting value start in different point than zero.

Reading Configuration: Users may have no measurement reading on either CH A or CH B digital display section, or no saved SetPoint setting displayed if these following Reading Configuration Items as *Gate Time, Debounce Time, Number of Digit* and *Decimal Point* are not selected correctly and properly:

4.7.4.1.5 A Gate Time (ms):

Length of time in which the Channel A of device accepts input pulses for a single rate calculation. The longer Gate time, the better the resolution. (it is not used for the rate calculation; a similar, but much more accurate method called Measurement Time is used). Its default value is 1000 ms and its max. value is 65535.

4.7.4.1.6 B Gate Time (ms):

Length of time in which the Channel B of device accepts input pulses for a single rate calculation. The longer Gate time, the better the resolution. Its default value is 1000 ms and its max. value is 65535.

4.7.4.1.7 A Debounce Time (ms):

Length of time in which functions as the filter in case of the Channel A input is connected with a contact closures signal to eliminate the de-bounce effect for better response of readings.

4.7.4.1.8 B Debounce Time (ms):

Length of time in which functions as the filter in case of the Channel B input is connected with a contact closures signal to eliminate the de-bounce effect for better response of readings. Therefore Debounce Time must be zero (0) also as default if Frequency Measurement or Mode is selected.



Make certain that Debounce Time must be zero when operating with frequency signals.

4.7.4.1.9 Reading Format:

Select 2 available Format options for all Readings as following: Decimal (as default) or Exponent to display on the Chart.

4.7.4.1.10 Number of Digit:

For users' application and equipment requirement of a limited number of digits to be displayed properl.

For example: user may want to connect with remote display, which always has hardware limitation in term of number of display digits. This feature must be use in combination of *Decimal Point* setting because it only specifies limit the number of digits before decimal point therefore if the measurement readings are exceeding the specified setup *Number of Digit*, Channel A or B reading value will display "Overload".

With the pull-down submenu, there are 10 available options from 0 to 9 to select for users' measurement value displayed.

4.7.4.1.11 Decimal Point:

With the pull-down submenu, there are 10 available options from 0 to 9 to select number of decimal point.

4.7.4.2 Counting Mode:

There are two counting modes available as following:

4.7.4.2.1 Combined A-B mode:

Select from this pull-down submenu the calculation types to perform between values of 2 input signals and display the results with extra graph and digital values.

These modes require both input signals for measurement and are available as following:

+ (addition as default)

- (subtraction)

x (multiplication)

/ (division)

4.7.4.2.2 Counter Mode:

Select counting direction either UP (as default) or Down.

4.7.5 Terminal / Remote (Tunneling) Server Setup

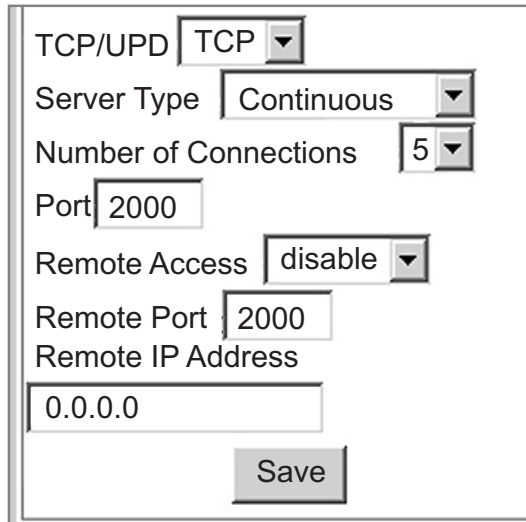

TCP/UDP

Server Type

Number of Connections

Port

Remote Access

Remote Port

Remote IP Address

Figure 4.19 Terminal / Remote (Tunneling) Server Setup

4.7.5.1 TCP/UDP*:

The iServer supports *TCP* and *UDP* protocols (default is TCP). If UDP is selected, it can be configured either for Broadcast UDP or Directed UDP. In case of Broadcast UDP, the iServer will transmit the data to every node on the network. This can be accomplished if the Remote IP Address is set to 255.255.255.255.

The Broadcast UDP is a practical solution when one iServer needs to communicate with multiple nodes over the network. In the case of directed UDP, the iServer will transmit the data to a specific node on the network. This can be accomplished if the Remote IP Address is set to the IP address of that specific node.

4.7.5.2 Server Type:

Continuous mode sends all current measurement input values and update the graphic chart to Ethernet, continuously, every one second. It is mainly used to send readings to a remote display.

Command mode needs a command to query the iServer to get the response back to the querying device. However all details of measurement are still updating including the chart.

4.7.5.3 Number of Connections:

The range is from 0 to 5.

If 0 is selected, the Terminal Server feature is disabled.

1-5 (TCP mode) can allow the number of querying device to receive the response from the iServer

If 1 is selected, only one network connection can be made to the device 's Ethernet port.

Any number more than 1 would allow the network hosts to monitor (read only) the traffic on the device 's Ethernet port simultaneously, but only one network host would be allowed to read and write (default is 5).

4.7.5.4 Port:

Port 2000 is the default TCP port for the iServer's port to which the device is connected. Ports 1000 (used for HTTPget, refer to **Section 4.9**), 2002, 2003, and 2004 are reserved for internal use.

Note

Terminal Server usually describes a device that exchanges data between Ethernet/TCP/IP networks and RS-232/RS-485 systems. With this iServer, the data is obtained digitally from the device (irrelevant to RS-232 or RS-485 interface) and can be accessed from anywhere on the network.

A computer program, such as NEWPORT's Mail Notifier, OPC Server, iLOG or httpget can send TCP requests and obtain readings using the Terminal Server feature.

4.7.5.5 Remote Access:**

Remote Access can be enabled and disabled.

Note

*TCP/UDP: when UDP mode is selected, Remote Access should be disabled and Remote IP and Port are the UDP remote listening IP and Port. If the Remote IP is set to 255.255.255.255, the UDP packet becomes a broadcasting packet which will allow any device listening to the Remote port to receive the packet.

**If Remote Access is enabled, Terminal Server is automatically disabled.

4.7.5.6 Remote Port: (default 2000) the remote port number for the connection. Ports 1000 (used for HTTPget, refer to **Section 4.9**), 2002, 2003, and 2004 are reserved for internal use.

4.7.5.7 Remote IP Address: iServer can establish a connection to a remote device (e.g. an iLD Remote Display with iServer) with this IP.

4.7.5.8 List of Available Communication Commands:

Table 4.2 List of Communication Commands

Command List	Command Response	Function
*SRP	a=xxx	Device Measurement Mode/Type
	b=xxx	CH A & CH B Combined input reading (A-B F or A-B T Mode)
	c=xxx	CH A input reading value
	d=xxx	CH B input reading value
	e=xxx	Your own-defined Name of Experiment/Measurement Task
	f=xxx	Unit of Input Value (definable)
	g=ABC	= 3 bits: A=1st bit: the transmit active bit B=2nd bit: the SP1 active bit C=3rd bit: the SP2 active bit
	h=xxx	SP1 (setpoint 1) value (A Batch value if Batch mode used)
	i=xxx	SP2 (setpoint 2) value (B Batch value if Batch mode used)
	j=xxx	Batch A Number (Number of A Batches)
	k=xxx	Batch B Number (Number of B Batches)
	l=xxx	A-B mode sign.
M=xxx	User-definable time/date stamp of Input Reading.	
*SRR		A-B mode reading
*SRA		Channel A input reading
*SRB		Channel B input reading
*SRX	Reset_A	Reset Channel A counter to 0
*SRY	Reset_B	Reset Channel B counter to 0

4.8 Telnet Setup

Telnet stands for Telecommunications Network, is a protocol that provides a way for users (or clients) to connect to computers (or servers) on a network, whether in the next building or across the world.

Example: C:\>Telnet 192.168.1.200 2002

You will then get the following screen.



Figure 4.20 Telnet Login into the iServer

You can open a Telnet session using other terminal emulation programs like Tera Term Pro (downloadable from the internet), which is a free software for MS-Windows. It supports VT100 emulation, Telnet connection and serial com port connections.

Set the *Number of Connections* to 1-5 (not 0) using telnet simulation program connect to the iServer.

In *Continuous* mode, the telnet terminal will receive continuous messages from the iServer.

In *Command* mode, the command can be sent to query the iServer and get a response back. Refer to **Figure 4.20**

4.8.1 Send Remote Reset:

Telnet port 2002 will bring a terminal for admin password. After typing the password and following with the end character, the message Admin. Login Successful will be showed on the terminal. Now type "reset" following with return character to reset the iServer. If no character is received within 20 second, the terminal will be closed automatically.

4.8.2 Send Commands Manually:

Setup check list as following:

Telnet port 2000

Number of Connections is different than 0

Command mode

Telnet session is opened by Tera Term Pro software

Commands as listed from **Table 4.2**

4.8.3 Sending *SRP command for Data Parameter String

Refer to **Figure 4.21**, the response is identical to the *Message Item Window* display data. Refer to **Table 3.1** iServer Device Chart for details.

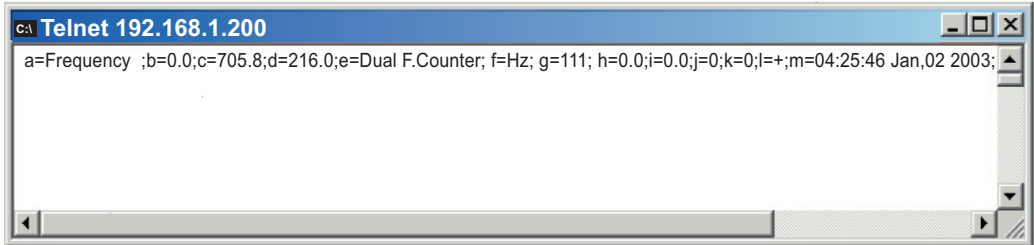

Figure 4.21. Response of Command *SRP inquiry Using Terminal Setup

4.8.4 Remote Display Format for Measurement Readings:

Terminal Server setup check list as following:

- Telnet port 2000
- Number of Connections is different than 0
- Continuous mode
- Telnet session is opened by Tera Term Pro software

4.8.5 A-B Mode:

This is an example of A+B frequencies Mode or A-B F mode and A-B mode is +. A is the value of Frequency input at Channel A input, B is the value of Frequency input at Channel B input and R is the result or sum of A+B values. Refer to **Figure 4.22**.

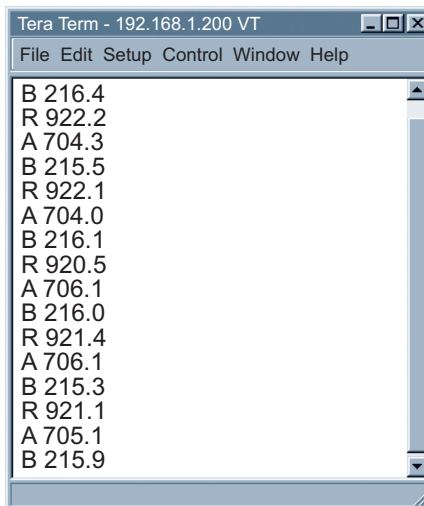

Figure 4.22 Dual Frequency Counter in A-B (+) Mode is Displayed Under Continuous Mode Using Remote Terminal Server

4.9 HTTPGET Program

The Httpget software is used to send a single HTTP or TCP request to an iServer product. In contrast, the telnet or Hyperterminal programs allow a continuous connection with multiple requests to be sent to the iServer product.

Generally httpget is used for simply programming an IP address to the iServer or for quickly obtaining a reading of from a device.

The iServer product must be configured from the configuration web page so that the "Server Type" value is set to "Command" (This is positioned under the heading of Terminal Server). Also the "Number of Connections" may need to be set to "0" to enable Port 1000 (Port 1000 is for access in a non-standard terminal mode). To use Port 2000 access (where "2000" is the value stored in "Port"), the Number of Connections should be set to "2" for general usage. The value of 2 can later be changed to a value from 1 to 5 depending on needs for secure access or fault tolerance.

Whenever Terminal Server service (using Port 2000 by default) is required, the # of connections/connections must be set to a value from 1 to 5. The Terminal Server mode is the recommended mode for the most reliable connection when operating with NEWPORT software or with other programs supporting TCPIP communications. The Port 1000 access can be used with NEWPORT software and may be needed with some iServer products when you need to view readings from the web page while simultaneously collecting data through TCPIP communications.

4.9.1 HTTPGET using Port 1000

You can setup and read the information from the iServer by using the HTTPGET program. The following program can be used to read data from the embedded server firmware by using TCP port **1000**. The command string is sent to this TCP port, then the response can be read back from the same socket.

The Httpget.exe file is used to setup and read information from the iServer. This file will be automatically installed when you install the MailNotifier software available on our website and CD.

Notes on using **Httpget** :

The Httpget.exe program is installed to the windows directory (usually c:\winnt or c:\windows) when installing the Mail Notifier software.

1. Open up a command window (or have a DOS window)
 - a) Click on start menu
 - b) Click on "Run"
 - c) In the dialog box that appears, type "cmd" or "command" and click on "OK" button.
 - d) A command window should now appear.
2. If you now type "httpget" and press the "enter" key, the program options should be displayed.
3. Next run httpget with the options displayed below

```
httpget -r -S "*"SRA" 192.168.1.96:1000
```

then:

```
httpget -r -S "*"SRB" 192.168.1.96:1000
```

and:

```
httpget -r -S "*"SRP" 192.168.1.96:1000
```

4.9.1 HTTPGET using Port 1000 (continued)

where:

- r -S are parameters needed for the command string
- *SRA is the read command (of Channel A) in the first line.
- *SRB is the read command (of Channel B) in the second line.
- *SRP is the read command (of data string including configuration and all reading values) in the third line.
- 192.168.1.96 is an IP address
- 1000 is a socket port number

Response: located right after each command line executed

384.8 value of Channel A input

212.9 value of Channel B input

a=A-B Fmode ; b=596.3;c=383.7;d=212.6;e=Dual F.Counter;

f=Hz;g=111;h=0.0;i=0.0;j=0;k=0;l=+;m=05:55:56 Jan,03 2003.

Refer to **Table 4.1**.

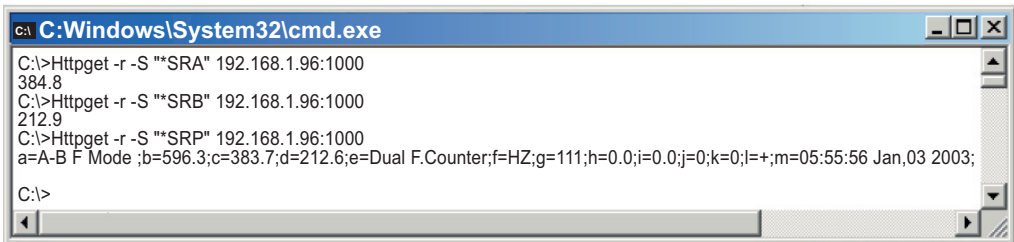

```
C:\Windows\System32\cmd.exe
C:\>Httpget -r -S **SRA" 192.168.1.96:1000
384.8
C:\>Httpget -r -S **SRB" 192.168.1.96:1000
212.9
C:\>Httpget -r -S **SRP" 192.168.1.96:1000
a=A-B F Mode ; b=596.3;c=383.7;d=212.6;e=Dual F.Counter;f=Hz;g=111;h=0.0;i=0.0;j=0;k=0;l=+;m=05:55:56 Jan,03 2003;
C:\>
```

Figure 4.23 An Example of using Httpget Program

4.9.2 HTTPGET and ARP to setup Device IP Address

 Use the iCONNECT software, which may be downloaded from our website, to do these IP changes whenever possible.

Use ARP first to assign the mac address to a static IP address in computer arp table by this command:

```
arp -s 192.168.1.200 00-03-34-00-00-06-b6
```

Then use the following command to assign new IP to the device:

```
Httpget -r -S "00000000" 192.168.1.200:1
```

where:

"00000000" is admin. password. If the password is wrong, the unit will ignore the new IP. If the new IP is taken, you will get the message " New IP is Assigned" after the httpget command. The device will reset automatically. (TX and RX led is on for 2 second).

"192.168.1.200" is an example of an IP address. It is replaced with IP address suitable for your network

"00-03-34-00-00-06-b6" is replaced with your iServer product MAC address.

4.10 ARP Protocol

ARP is the Internet layer protocol responsible for matching or obtaining the MAC (hardware) address that corresponds to a particular IP address. The ARP command allows the user to view the current contents of the ARP cache of the local computer (residing on the same network). Microsoft includes the ARP.EXE utility for viewing and modifying the ARP cache with its Windows products. The following ARP commands can be used to view cache entries:

- **arp -a** → Use this command to view all ARP cache entries.
- **arp -a** plus **IP address** → Use this command to view ARP cache entries associated with one particular interface on a network with multiple adapters.
- **arp -g** → Same as arp -a.
- **arp -N** → Use this command to display ARP entries for specific network interface.
- **arp -s** plus **IP address** plus **Physical address** → Use this command to manually add a permanent static entry to the ARP cache.
- **arp -d** → Use this command to manually delete a static entry.

 Ping the destination computer using IP address first before using the arp -a command.

The following window shows examples of arp commands and responses.

- Your computer has an IP address of **192.168.1.118**
- The destination computer has an IP address of **192.168.1.96**

4.10 ARP Protocol (continued)

```
MS-DOS Prompt
Auto
C:\>arp - 192.168.1.96
No ARP Entries Found
C:\>ping 192.168.1.96
Pinging 192.168.1.96 with 32 bytes of data:

Reply from 192.168.1.96=bytes=32 time=5ms TTL=32
Reply from 192.168.1.96=bytes=32 time=3ms TTL=32
Reply from 192.168.1.96=bytes=32 time=3ms TTL=32
Reply from 192.168.1.96=bytes=32 time=4ms TTL=32

C:\>arp -a 192.168.1.96
Interface: 192.168.1.118
Internet Address Physical Address Type
192.168.1.96 00-03-34-00-00-23 dynamic
C:\>arp -s 192.168.1.96 00-03-34-00-00-23
C:\>arp -a 192.168.1.96
Interface: 192.168.1.118
Internet Address Physical Address Type
192.168.1.96 00-03-34-00-00-23 static
C:\>arp -d 192.168.1.96
C:\>arp -a 192.168.1.96
No ARP Entries Found
C:\>
```

Figure 4.24 ARP Commands and Responses

4.11 Remote Access (Tunneling)

To "tunnel", in this context, is to transmit data between two points through a private conduit on a shared or public network. The network could be an Ethernet LAN, a WAN, or the Internet. The iServer allows for a connection between a serial device and a PC, or between two serial devices, using an existing network rather than dedicated wiring.

The connected serial devices to iServer's can communicate with each other back and forth over the networks. This characteristic is called Tunneling and is illustrated in **Figure 4.25**.

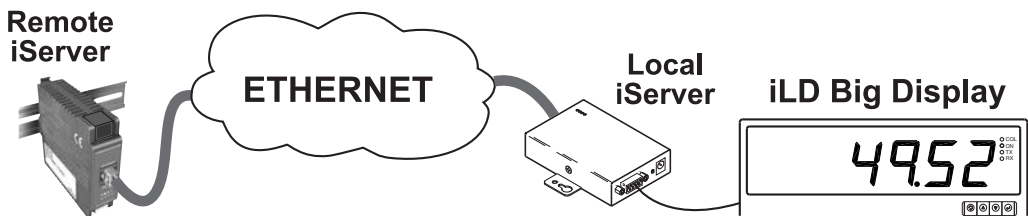

Figure 4.25 Device-to-Device Communication

In order to use this Tunneling feature, some settings are required within the local and remote iServer's.

4.11.1 Local iServer

1. An IP address should be assigned to the iServer either statically or using a DHCP server.
2. Use a browser to access iServer's WEB server. Simply type the iServer's IP address at the browser's URL location (i.e. <http://192.168.1.200>).
3. Click on Update button.
4. Click on Configuration button and enter the password (the default password is **12345678**).
5. Click on Configuration button once again and now you're on the configuration page.
6. Under Terminal Server section, set the Number of Connections to "5".
7. Click on Save button for the changes to take place.
8. Make sure that the serial connection between the local iServer and the serial device is valid and the serial settings like baud rate, stop bit, parity, etc. are configured correctly.

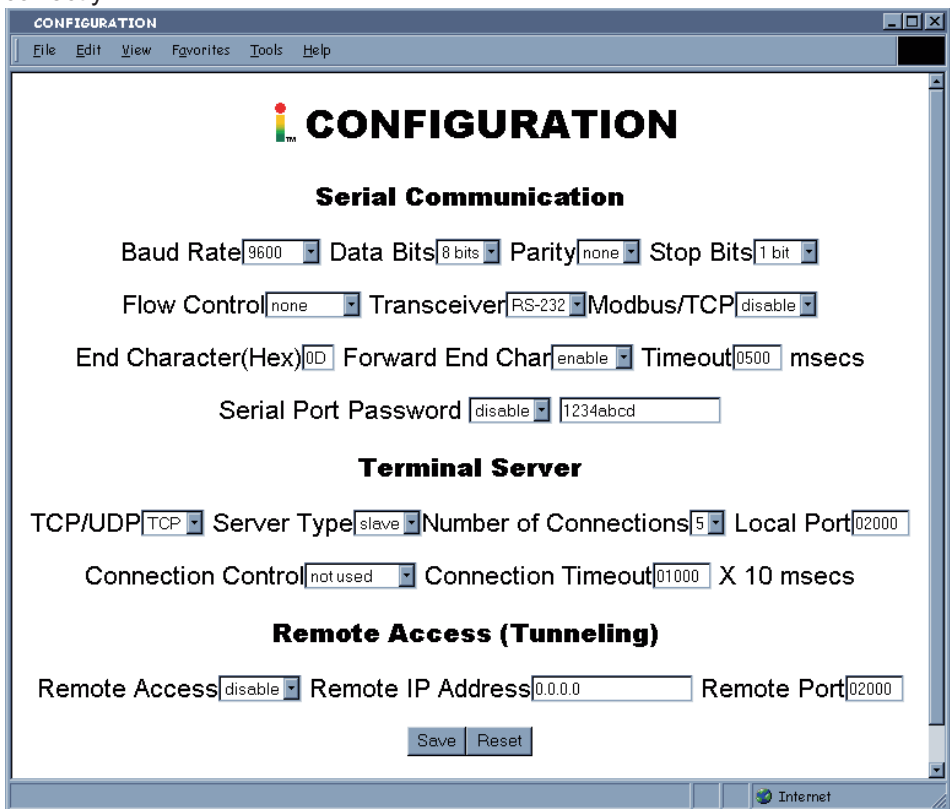
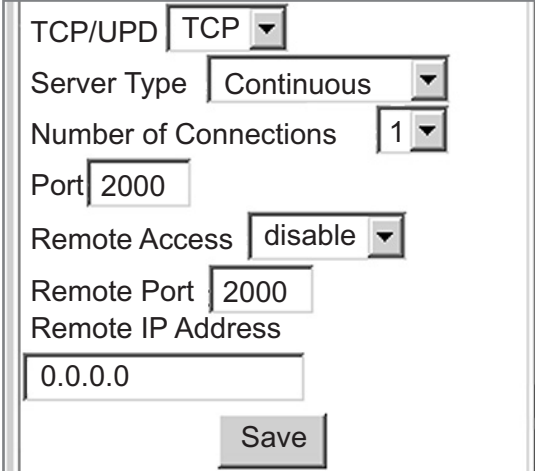

Figure 4.26 Local iServer Configuration Terminal Server/Remote Access (Tunneling)

4.11.2 Remote iServer

1. An IP address should be assigned to the Frequency Pulse iServer either statically or using a DHCP server.
2. Use a browser to access iServer's WEB server. Simply type the iServer's IP address at the browser's URL location (i.e. ***http://192.168.1.84***).
3. Click on Update button.
4. Click on Configuration button and enter the password (the default password is **12345678**).
5. Click on Configuration button once again and now you're on the configuration page.
6. Under Terminal Server section, set the Number of Connections to "1" and Server Type to "**Continuous**".
7. Under Remote Access section,
 - a. Enter the IP address of the remote iServer (i.e. **192.168.1.200**).
 - b. Use the default Remote Port **2000**.
 - c. Set the Remote Access to "**enable**".
8. Click on Update button for the changes to take place.

At this point, reset the power, first on the remote and then the local iServer and initialize the local serial device to send or request data.



The screenshot shows a configuration window with the following fields and values:

- TCP/UDP: TCP (dropdown)
- Server Type: Continuous (dropdown)
- Number of Connections: 1 (dropdown)
- Port: 2000 (text input)
- Remote Access: disable (dropdown)
- Remote Port: 2000 (text input)
- Remote IP Address: 0.0.0.0 (text input)
- Save (button)

Figure 4.27 Remote iServer Configuration Terminal Server/Remote Access (Tunneling)

4.12 Access Control Descriptions and Functions

This section describes the "Access Control" page of the iServer's Web interface (although some of the items of this page were described in previous **Section 4.2**). This page allows the users to set up the network and security parameters of the iServer.

To get into the Access Control page, the user will be prompted with an Admin Password. The default Admin password is **00000000** and is changeable, if desired.

The screenshot shows a web browser window titled "ACCESS CONTROL" with the address bar set to "http://192.168.1.200". The main content area displays the "ACCESS CONTROL" configuration page. It includes the following fields and controls:

- Login Password: 12345678
- Admin Password: 00000000
- Host Name: eis21d9
- MAC Address: 00:03:03:00:21:D9
- IP Address: 192.168.1.200
- Gateway Address: 0.0.0.0
- Subnet Mask: 255.255.255.0

Below the fields are "Save" and "Reset" buttons. At the bottom, there is a "Power Recycle" button and a "Main Menu" link.

Figure 4.28 Access Control

Login Password: This allows users to access and modify the "Configuration/Device Setup" page. The default password is 12345678. This password can be up to 16 alpha-numeric case-sensitive characters. If there is no password assigned (blank box) the iServer will not require password to access and modify the "Configuration Setup" page.

Admin (administrator) Password: This allows users to access and modify the "Access Control" page. The default password is 00000000. This password can be up to 16 alphanumeric case-sensitive characters. If there is no password assigned (blank box) the iServer will not require password to access and modify the "Access Control" page.

Host Name: Refer to **Section 3.4, DNS**.

MAC Address: This is also called Hardware address or Ethernet address, which is assigned to the iServer at production. The MAC (Media Access Control) address is the iServer's unique hardware number and is not changeable.

IP Address: The IP (Internet Protocol) address is a 32-bit number that identifies each sender or receiver of information that is sent in packets across the Ethernet or the Internet. The iServer's default IP address is **192.168.1.200**. The iServer's IP address should be changed to fit user's networking environment. Consult with your IT department for obtaining an IP address.



The DHCP will be enabled in the iServer if its IP address is set to 0.0.0.0. The DHCP can also be enabled by setting the dip switch number 3 to ON position.

4.12 Access Control Descriptions and Functions (continued)

Gateway Address: A gateway is a network point that acts as an entrance to another network. A gateway is often associated with a router, which knows where to direct a given packet of data that arrives at the gateway. If the iServer is sending packets to another network node that is not on the same network on which the iServer is connected, a gateway address needs to be given to the iServer. The gateway address should be the IP address of the router connected to the same LAN to which the iServer is connected. The iServer's default gateway address is 0.0.0.0. Consult with your IT department for obtaining a gateway address.

Subnet Mask: It's a 32-bit number that is used to determine which part of the IP address is the network portion and which part is the host portion. The iServer's default subnet mask is **255.255.255.0**. Consult with your IT department for obtaining a subnet mask.

Time and Date: allow users to setup the local time of specific applications, and these values will reset to default, as device's power is recycled.

4.13 iLOG Software

This is an Excel application software that can log the two channels from an iServer over the local network (Ethernet) or the internet.

- Download the iLog software from the website listed in this manual.
- Install iLog software on a networked PC. This software is compatible with Windows 95, 98, NT, 2000, XP, Windows Vista and Windows 7 (32 and 64-bit).
- If you have Excel 2007 or higher, when installing iLog choose "Custom" installation option and on the next window check the box for "Excel 2007 Apps" and continue the installation to the end.
- For complete information of how to use the iLog software, click on the HELP button.
- There is a list of Error Messages in **Appendix E**.

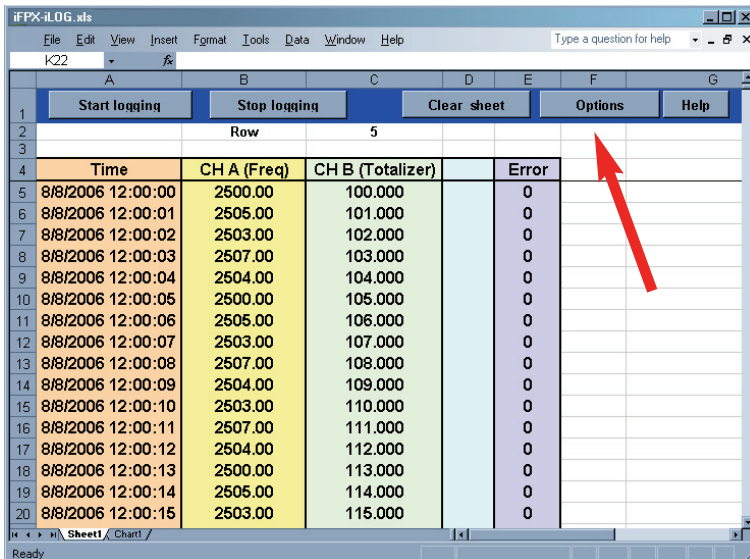

Time	CH A (Freq)	CH B (Totalizer)	Error
8/8/2006 12:00:00	2500.00	100.000	0
8/8/2006 12:00:01	2505.00	101.000	0
8/8/2006 12:00:02	2503.00	102.000	0
8/8/2006 12:00:03	2507.00	103.000	0
8/8/2006 12:00:04	2504.00	104.000	0
8/8/2006 12:00:05	2500.00	105.000	0
8/8/2006 12:00:06	2505.00	106.000	0
8/8/2006 12:00:07	2503.00	107.000	0
8/8/2006 12:00:08	2507.00	108.000	0
8/8/2006 12:00:09	2504.00	109.000	0
8/8/2006 12:00:10	2503.00	110.000	0
8/8/2006 12:00:11	2507.00	111.000	0
8/8/2006 12:00:12	2504.00	112.000	0
8/8/2006 12:00:13	2500.00	113.000	0
8/8/2006 12:00:14	2505.00	114.000	0
8/8/2006 12:00:15	2503.00	115.000	0

Figure 4.29 iLOG Software Logging Data

4.14 Mail Notifier Software

The Mail Notifier Software can be used only with NEWPORT Electronics instruments. For complete information of how to use the Mail Notifier software, click on the Help menu of the main window.

The Mail Notifier software generates email notifications for alarm conditions. Users can be notified automatically of alarm conditions monitored via internet connections throughout the world. By use of the email forwarding of alarm conditions, alarm conditions can be monitored on a network isolated from the internet and forwarded to connections on the Internet.

The Mail Notifier utility operates under Windows 98, NT 4.0, 2000, and XP in conjunction with existing email that supports the MAPI messaging interface. If MS Outlook has been loaded, the MAPI support should be available.

4.14.1 Installation

The Mail Notifier must be loaded on a computer running Microsoft Windows (versions specified earlier) using an email program that provides MAPI access. Network access must be available between this computer and the iServer. Network access must also be available from this computer to the appropriate email server and from the email server to the recipient's email server.

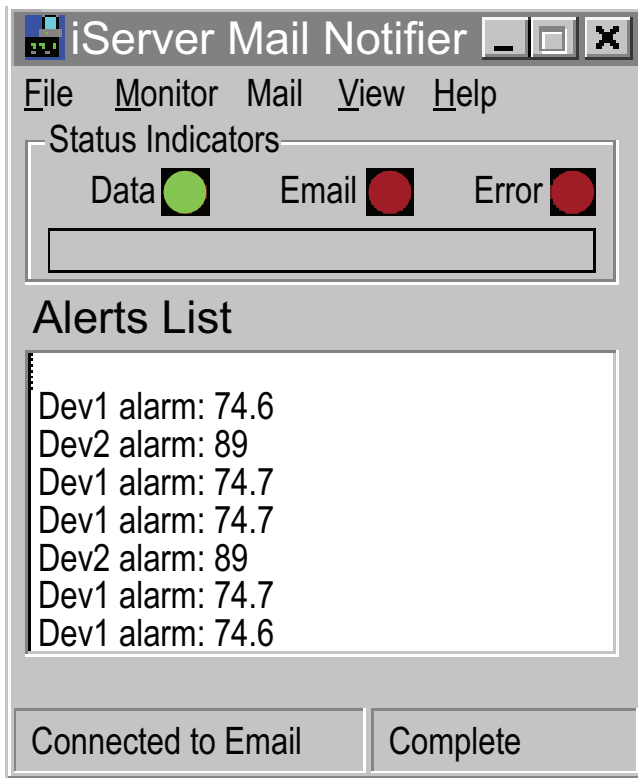

Figure 4.30 iServer Mail Notifier Main Window

4.14.2 Program Options Setup and Configuration

Complete program setup requires:

- Entering a recipient for the email
- Specifying connection details to MAPI services.
- Defining alarms for devices, and selecting how and when the email will be active.

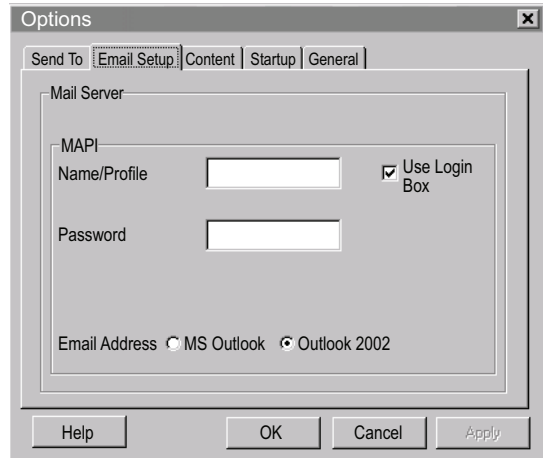

Figure 4.31 iServer Mail Notifier Profile Setup

Email Address Setup

The email addresses must be entered using individual addresses or alias. Select “Options” from the “View” menu and enter the email addresses on the “Send To” screen. This will be the list of email addresses to which alarm notifications will be sent.

Email Setup

The Mail Notifier is compatible with original MS Outlook™ and Outlook™ 2002 to 2005.

The Mail Notifier will attempt to automatically identify whether the Outlook is a newer version. A red bar appears under the Mail Notifier splash window to confirm that the detection of the 2002 or newer version is acceptable. With the newer versions, no additional steps should be taken to enable the connection between the Mail Notifier and the Email server.

Note

MS Outlook tends to require that the users respond to a “login box” in order for email access to be activated for Mail Notifier. Some other email clients may allow for Mail Notifier to gain access without user login, as may be desired for a system recovering from a power outage. See the Help files for more information

4.14.2.1 Sending email Messages to a Cell Phone

In the **Send To** field, you can use the following format to have the Mail Notifier send an email message to your cell phone. Since most cell phones are capable of receiving text messages you just need to find the correct email format for your cell phone provider.

T-Mobile	phone_number@tmomail.net
Virgin Mobile	phone_number@vmobl.com
AT&T	phone_number@txt.att.net
Sprint	phone_number@messaging.sprintpcs.com
Verizon	phone_number@vtext.com
Nextel	phone_number@messaging.nextel.com

“phone_number” is your 10 digit cell phone number.

4.14.3 Device Setting and Configuration

Device setup requires:

- Entering the IP address for iServer device (for example **192.168.1.200**).
- Specifying Socket number (1000 or 2000 depending on iServer settings).
- Defining RS485 Unit # interface address (1 to 199). Enter "0" for RS232 interface or for iServer.
- Entering Reading command. Normally set to SRT to obtain reading from the devices. If you want to change this setting, refer to HTTPget **Section 4.9**.
- Defining the Alarm setup (High/Low, High value, or Low value).
- Specifying Pause Interval. It determines how many seconds each subsequent alarm notification will be sent.
- Determining Monitor interval. It establishes the interval or time resolution in seconds for which readings will be obtained from the device.

The screenshot shows a dialog box titled "Alarm Editor" with a close button (X) in the top right corner. The dialog is divided into two main sections: "Device Info (1 of 2)" and "Alarm Configuration".

Device Info (1 of 2)

Server IP Address	192.168.1.200
Socket Number	1000
Bus Address/Device ID	1
Description	
Src ID	Dev 2
Reading Cmd	SRTF

On the right side of the Device Info section, there are four buttons: "OK", "Cancel", "Help", and "Add". Below these buttons are two more buttons: "Add" and "Del". There is also a checkbox labeled "Only Monitor Access to iServer device" which is currently unchecked.

Alarm Configuration

Alarm Type	Alarm High	Info Message	
Alarm High	73	Email Interval	0.05 hrs.
Alarm Low	0	Monitor Interval	0.5 min.
		Alarm Hold Time	0.0 min.

Figure 4.32 iServer Mail Notifier Device Setting

PART 5

SPECIFICATIONS

INPUT TYPE

Dual Input A and B:

Min. Low level signal input
(magnetic pickups): 120 mV
(SW3: #6, #8 "ON")

Open Collector NPN:

Max. current source: 1.66 mA
(with 3K ohm pull-up)

Open Collector PNP:

Max. current sink: 5 mA
(with 1K ohm pull-down)

TTL / CMOS Input:

Low ≤ 0.8 V, High ≥ 3.5 V
For Input: 1 Hz to 30 KHz

Low ≤ 0.8 V, High ≥ 10 V
For Input: 1 Hz to 60 KHz
(SW3: #5, #7 "ON")

OPERATING MODES

Frequency:

Range = 1 Hz to 100 KHz

Max. Input Frequency:

Input Level 0-5 V: 50 KHz

Input Level 0-12 V: 100 KHz
(SW3: #5, #7 "ON")

Frequency Resolution:

1 Hz to 100 KHz / 0.000000001 Hz

Totalizer:

Range = 0 to 999999999*

Totalizer Accuracy: 0.3%

A-B Totalize/Frequency:

(A input used with B input):

Could be A+B, A-B, Ax B, A/B

Range = -999999999 to 999999999*

Batch:

Similar to Totalizer except the

Batch = 0 to 65535

Quadrature:

Range = -999999999 to 999999999*

*Resolution is 1 count

Output A and B:

Open-collector transistors, rated 150mA sink, 30V. For external supply.

ISOLATION

Dielectric strength per 1 minute test based on EN 61010.

iFPX-W: Power to ethernet: 1500 Vrms

Power to input/output: none

Input/output to ethernet: 1500 Vrms

iFPX-D: Power to ethernet: 1500 Vrms

Power to input/output: 1500 Vrms

Input/output to ethernet: 1500 Vrms

Input Impedance: 1M ohm to +EXC 5V

Excitation: 5V at 25mA (per channel)

Debounce Time: programmable

Gate Time: programmable

NETWORK INTERFACE

Interface: Ethernet 10Base-T

Connector: RJ45

Protocols: TCP/IP, UDP/IP, ARP, ICMP, DHCP, DNS, HTTP, Telnet

INDICATORS (LED's)

Power, Network Activity, Network Link and Diagnostics

MEMORY

512 Kbyte Flash, 16 Kbyte SRAM

MANAGEMENT

Embedded Web server, Telnet login, Serial login

EMBEDDED WEB SERVER

Serves dynamic Web pages and Java applets (256 Kbyte capacity)

POWER INPUT - iFPX-W

Input: 9 Vdc @ 200 mA

Safety Qualified ac/dc power adapter with 9Vdc @ 0.5A min, included.

POWER INPUT - iFPX-D

Input: 10-32 Vdc

Consumption: 2 W max.
(DC Power supply sold separately)

POWER INPUT - iFPX-PCB

Input: 5 Vdc @ 150 mA

ENVIRONMENTAL

Operating Temperature:
0 to 70°C (32 to 158°F)

Storage Temperature:
-40 to 125°C (-40 to 257°F)

Relative Humidity:
90% @ 40°C non-condensing

PACKAGING - iFPX-W

Material:
Metal case with flange mount

Dimensions:
20.8H x 61.6W x 90.3D mm
(0.83 x 2.93 x 3.56 in)

Weight: 180 g (0.4 lbs.)

PACKAGING - iFPX-D

Material:
Polycarbonate case DIN Rail mount

Dimensions:
90.2H x 25.1W x 115.0D mm
(3.54 x .99 x 4.53 in)

Weight: 113 g (0.25 lbs.)

PACKAGING - iFPX-PCB

Material: FR-4

Board Surface area:
approximately 76 sq mm (3 sq inches)

Weight: 23 g (0.05 lbs.)

PART 6
FACTORY PRESET VALUES

PRESET PARAMETERS	FACTORY DEFAULTS
Network Interface:	
IP Address	192.168.1.200
Gateway Address	0.0.0.0
Subnet Mask	255.255.255.0
Device Host Name	eis and Last 4 digits from the MAC address
Login Password	12345678
Admin Password	00000000
DHCP	Disabled
Flow Control	None
End Character	0D (Hex) (Carridge Return)
Device Type:	
	Frequency
Setpoint/Terminal/Remote:	
SP1 and SP2 Values	0
SP1 and SP2 Latch Mode	UnLatch
SP1 and SP2 Active Mode	Above
SP1 and SP2 Dead Band	0
SP1 and SP2 Active Status	High
TCP/UPD	
Server Type	Continuous
Number of Connections	5
Port #	2000
Remote Access	Disable
Remote Port	2000
Remote IP Address	0.0.0.0
Utility:	
A and B Scale	1.0
A and B Offset	0.0
A and B Gate Tlme	1000
A and B Debounce Time	0
Reading Format	Decimal
Number of Digits	9
Decimal Point	0
A-B Mode	+
Counter Mode	Up

User of this manual should be familiar with following definitions:

ARP (Address Resolution Protocol) is a protocol for mapping an Internet Protocol address (IP address) to a physical machine address that is recognized in the local network. For example, the IP address in use today is an address that is 32-bits long. In an Ethernet local area network, however, addresses for attached devices are 48-bits long. (The physical machine address is also known as a Media Access Control or MAC address.) A table, usually called the ARP cache, is used to maintain a correlation between each MAC address and its corresponding IP address. ARP provides the protocol rules for making this correlation and providing address conversion in both directions.

Ethernet is a network protocol defined by the IEEE 802.3 standard. Ethernet-based networks use MAC Address rather than IP Address to exchange data between computers. By using ARP and adding TCP/IP support, Ethernet devices may be connected as part of the Internet. An Ethernet LAN typically uses coaxial cable or special grades of twisted pair wires. The most commonly installed Ethernet systems are called 10BASE-T and provide transmission speeds up to 10 Mbps. Devices are connected to the cable and compete for access using a Carrier Sense Multiple Access with Collision Detection (CSMA/CD) protocol.

IP (Internet Protocol) is the method or protocol by which data is sent from one computer to another on the Internet.

IP address (Internet Protocol address) is a 32-bit number that identifies each sender or receiver of information that is sent in packets across the Internet.

IP Netmask is a 32-bit pattern of bits used to determine which part of the IP address is the network portion and which part is the host portion.

MAC (Media Access Control) Address is your computer's unique hardware number. When you're connected to the Internet from your computer, a correspondence table relates your IP address to your computer's physical (MAC) address on the LAN.

Ping is a utility that tests the network connectivity. It is used to determine if the host is capable of exchanging information with another host.

Port number/Socket number is a way to identify a specific process to which an Internet or other network message is to be forwarded when it arrives at a server. It is a predefined address that serves as a route from the application to the Transport layer or from the Transport layer to the application of the TCP/IP system.

Connections are a method for communication between a client program and a server program in a network and defined as "the endpoint in a connection." Information transferred across the Internet primarily occurs between connections.

TCP/IP (Transmission Control Protocol/Internet Protocol) is the basic communication language or protocol of the Internet. When you are set up with direct access to the Internet, your computer is provided with a copy of the TCP/IP program just as every other computer that you may send messages to or get information from also has a copy of TCP/IP. TCP/IP often is used as a general term to indicate generic access to the Internet.

UDP/IP (User Datagram Protocol/Internet Protocol) is the TCP/IP standard protocol that allows an application program on one machine to send a datagram to an application program on another. The UDP can be either in Broadcast or Directed form. The Broadcast UDP transmits data to every node on the same network. The Directed UDP transmits data to one node only.

An IP address is a unique 32-bit address assigned to a computer and includes:

- A network ID number identifying a network.
- A host ID number identifying a computer on the network.

All IP addresses have been divided into three smaller groups (classes) A, B and C

- **Class A** addresses have 8-bits of network ID and 24-bits of host ID. They can support a large number of hosts, approximately $2^{24} = 16,777,216$ computers per network.

The IP addresses range in binary from 00000001.xxxxxxxx.xxxxxxxx.xxxxxxxx
to 01111111.xxxxxxxx.xxxxxxxx.xxxxxxxx

The IP addresses range in decimal from 1.x.x.x to 127.x.x.x

Class A network ID's support a very large number of hosts.

- **Class B** addresses have 16-bits of network ID and 16-bits of host ID. They can support approximately $2^{16} = 65,536$ computers per network.

The IP addresses range in binary from 10000000 00000000.xxxxxxxx.xxxxxxxx
to 10111111 11111111.xxxxxxxx.xxxxxxxx

The IP addresses range in decimal from 128.0.x.x to 191.255.xxx.xxx

Class B network ID's support a medium number of hosts.

- **Class C** addresses have 24-bits of network ID and 8-bits of host ID. They can support approximately $2^8 = 256$ computers per network.

The IP addresses range in binary from 11000000.00000000.00000000.xxxxxxxx
to 11011111.11111111.11111111.xxxxxxxx

The IP addresses range in decimal from 192.0.0.xxx to 223.255.255.xxx

Class C network ID's support a small number of hosts.



The rest of the addresses are divided into two classes, D and E.

Class D networks are not assigned to the host. They are used for multicasting.
The address range from 224.x.x.x to 239.x.x.x

Class E networks are experimental or reserved addresses.

The address range from 240.x.x.x to 247.x.x.x

Appendix C

IP Netmask

IP Netmask or Subnet Mask is a 32-bit pattern of ones and zeros used to determine network portion of an IP address from the host portion of the IP address. Subnet mask is a network ID that is created by borrowing bits from host portion of IP address and using them as part of a network ID. The table below shows a default subnet mask for address Classes A, B, and C. Each bit that is set to "1" in the subnet mask corresponds to the bit in the IP address that is to be used as the network ID. Each bit that is set to "0" in the subnet mask corresponds to a bit in the IP address that is to be used as the host ID.

Address Class	Mask Binary Value	Mask Decimal Value or Dotted Notation
Class A	11111111 00000000 00000000 00000000	255.0.0.0
Class B	11111111 11111111 00000000 00000000	255.255.0.0
Class C	11111111 11111111 11111111 00000000	255.255.255.0

If your network requires more network ID's, you can extend the default subnet mask to include additional bits from the host ID. This allows for additional network ID's within the network. The table below shows some examples of subnet masks and bits moved from the hosts ID to create a new subnet.

Mask Dotted Notation	Mask Binary	Mask Bits
Class A		
255.0.0.0 (Default)	11111111 00000000 00000000 00000000	0
255.192.0.0	11111111 11000000 00000000 00000000	2
255.224.0.0	11111111 11100000 00000000 00000000	3
255.240.0.0	11111111 11110000 00000000 00000000	4
255.248.0.0	11111111 11111000 00000000 00000000	5
255.252.0.0	11111111 11111100 00000000 00000000	6
255.254.0.0	11111111 11111110 00000000 00000000	7
255.255.0.0	11111111 11111111 00000000 00000000	8
255.255.128.0	11111111 11111111 10000000 00000000	9
255.255.192.0.0	11111111 11111111 11000000 00000000	10
.....
255.255.255.252	11111111 11111111 11111111 11111100	22
Class B		
255.255.0.0 (Default)	11111111 11111111 00000000 00000000	0
255.255.192.0	11111111 11111111 11000000 00000000	2
.....
255.255.255.252	11111111 11111111 11111111 11111100	14
Class C		
255.255.255.0 (Default)	11111111 11111111 11111111 00000000	0
255.255.255.192	11111111 11111111 11111111 11000000	2
.....
255.255.255.254	11111111 11111111 11111111 11111100	6

To determine the number of valid hosts ID's remaining after subnetting, use the following equation: $2^n - 2$, where n is the number of octet digits left after the subnet mask.

Appendix D

ASCII Chart

ASCII Char	Dec	Hex	Binary No Parity	ASCII Char	Dec	Hex	Binary No parity
NUL	00	00	00000000	@	64	40	01000000
SOH	01	01	00000001	A	65	41	01000000
STX	02	02	00000010	B	66	42	01000010
ETX	03	03	00000011	C	67	43	01000011
EOT	04	04	00000100	D	68	44	01000100
ENQ	05	05	00000101	E	69	45	01000101
ACK	06	06	00000110	F	70	46	01000110
BEL	07	07	00000111	G	71	47	01000111
BS	08	08	00001000	H	72	48	01001000
HT	09	09	00001001	I	73	49	01001001
LF	10	0A	00001010	J	74	4A	01001010
VT	11	0B	00001011	K	75	4B	01001011
FF	12	0C	00001100	L	76	4C	01001100
CR	13	0D	00001101	M	77	4D	01001101
SO	14	0E	00001110	N	78	4E	01001110
SI	15	0F	00001111	O	79	4F	01001111
DLE	16	10	00010000	P	80	50	01010000
DC1	17	11	00010001	Q	81	51	01010001
DC2	18	12	00010010	R	82	52	01010010
DC3	19	13	00010011	S	83	53	01010011
DC4	20	14	00010100	T	84	54	01010100
NAK	21	15	00010101	U	85	55	01010101
SYN	22	16	00010110	V	86	56	01010110
ETB	23	17	00010111	W	87	57	01010111
CAN	24	18	00011000	X	88	58	01011000
EM	25	19	00011001	Y	89	59	01011001
SUB	26	1A	00011010	Z	90	5A	01011010
ESC	27	1B	00011011	[91	5B	01011011
FS	28	1C	00011100	\	92	5C	01011100
GS	29	1D	00011101]	93	5D	01011101
RS	30	1E	00011110	^	94	5E	01011110
US	31	1F	00011111	_	95	5F	01011111
SP	32	20	00100000	`	96	60	01100000
!	33	21	00100001	a	97	61	01100001
"	34	22	00100010	b	98	62	01100010
#	35	23	00100011	c	99	63	01100011
\$	36	24	00100100	d	100	64	01100100
%	37	25	00100101	e	101	65	01100101
&	38	26	00100110	f	102	66	01100110
'	39	27	00100111	g	103	67	01100111
(40	28	00101000	h	104	68	01101000
)	41	29	00101001	i	105	69	01101001
*	42	2A	00101010	j	106	6A	01101010
+	43	2B	00101011	k	107	6B	01101011
,	44	2C	00101100	l	108	6C	01101100
-	45	2D	00101101	m	109	6D	01101101
.	46	2E	00101110	n	110	6E	01101110

Appendix D

ASCII Chart Continuation

/	47	2F	00101111	o	111	6F	01101111
0	48	30	00110000	p	112	70	01110000
1	49	31	00110001	q	113	71	01110001
2	50	32	00110010	r	114	72	01110010
3	51	33	00110011	s	115	73	01110011
4	52	34	00110100	t	116	74	01110100
5	53	35	00110101	u	117	75	01110101
6	54	36	00110110	v	118	76	01110110
7	55	37	00110111	w	119	77	01110111
8	56	38	00111000	x	120	78	01111000
9	57	39	00111001	y	121	79	01111001
:	58	3A	00111010	z	122	7A	01111010
;	59	3B	00111011	{	123	7B	01111011
<	60	3C	00111100		124	7C	01111100
=	61	3D	00111101	}	125	7D	01111101
>	62	3E	00111110	~	126	7E	01111110
?	63	3F	00111111	DEL	127	7F	01111111

ASCII Control Codes

ASCII Char	Dec	Hex	Ctrl Key Equiv.	Definition	ASCII Char	Dec	Hex	Ctrl Key Equiv.	Definition
NUL	00	00	Ctrl @	Null Character	DC1	17	11	Ctrl Q	Data Control 1 - XON
SOH	01	01	Ctrl A	Start of Header	DC2	18	12	Ctrl R	Data Control 2
STX	02	02	Ctrl B	Start of Text	DC3	19	13	Ctrl S	Data Control 3 - XOFF
ETX	03	03	Ctrl C	End of Text	DC4	20	14	Ctrl T	Data Control 4
EOT	04	04	Ctrl D	End of Transmission	NAK	21	15	Ctrl U	Negative Acknowledge
ENQ	05	05	Ctrl E	Inquiry	SYN	22	16	Ctrl V	Synchronous Idle
ACK	06	06	Ctrl F	Acknowledge	ETB	23	17	Ctrl W	End of Trans Block
BEL	07	07	Ctrl G	Bell	CAN	24	18	Ctrl X	Cancel
BS	08	08	Ctrl H	Back Space	EM	25	19	Ctrl Y	End of Medium
HT	09	09	Ctrl I	Horizontal Tabulation	SUB	26	1A	Ctrl Z	Substitute
LF	10	0A	Ctrl J	Line Feed	ESC	27	1B	Ctrl [Escape
VT	11	0B	Ctrl K	Vertical Tabulation	FS	28	1C	Ctrl \	File Separator
FF	12	0C	Ctrl L	Form Feed	GS	29	1D	Ctrl]	Group Separator
CR	13	0D	Ctrl M	Carriage Return	RS	30	1E	Ctrl	Record Separator
SO	14	0E	Ctrl N	Shift Out	US	31	1F	Ctrl _	Unit Separator
SI	15	0F	Ctrl O	Shift In	SP	32	20		Space
DLE	16	10	Ctrl P	Data Link Escape					

Appendix E**iLog Error Messages**

Error #	Description	Note
-8003	User stopped logging readings.	
-10005	Failed to find the iServer.	Ethernet cable is disconnected, iServer is powered off, connections across the firewall require longer "connection to socket time out" setting.
-10006	Windows socket was closed.	
-10007	Windows socket error.	Wrong IP or wrong Port number was used.
-10008	The iServer failed to respond to a request.	Wrong IP or wrong Port number was used.
-10011	Response came empty.	No data was sent.
-10012	Device responded with "Serial Time Out" string.	Possibly the iLog is configured for wrong product model.
-10014	Terminal Server Mode when the Port is 1000.	Try Port 2000 in iLog configuration.
-15100	Error on obtaining the temperature reading.	Possibly the iLog is configured for wrong product model.
-15105	Error on obtaining the humidity reading.	Possibly the iLog is configured for wrong product model.
-15110	Error on obtaining the dew point reading.	Possibly the iLog is configured for wrong product model.

PART 7

APPROVALS INFORMATION

7.1 CE APPROVAL

 This product conforms to the EMC directive 89/336/EEC amended by 93/68/EEC, and with the European Low Voltage Directive 72/23/EEC.

Electrical Safety EN61010-1:2001

Safety requirements for electrical equipment for measurement, control and laboratory.

Basic Insulation

Pollution Degree 2

Dielectric withstand Test per 1 min

- Input Power to Ethernet Output: 1500Vac (iFPX-W and iFPX-D)
- Input Power to I/O lines: none (iFPX-W)
- Input Power to I/O lines: 1500Vac (iFPX-D)
- Ethernet Output to I/O lines: 1500Vac (iFPX-D)

Measurement Category I

Category I are measurements performed on circuits not directly connected to the Mains Supply (power).

Transients Overvoltage Surge (1.2/50uS Pulse)

- Input Power: 500V Transients Overvoltage
- Ethernet: 1500V Transients Overvoltage

Note: *The ac/dc power adaptor must have Safety Qualified Agency Approvals for CE with Double Insulation rating.*

The ac/dc power adaptor is 9Vdc.

The minimum output current rating is 500mA.

EMC EN61000-6-1:2001 (Immunity) and EN61000-6-3:2001 (Emmissions)

Immunity requirements for residential, commercial and light-industrial environments

- EMC Emissions Table 1, Class B
- EMC Immunity Table 1: Enclosure
Table 2: Signal Lines Ports
Table 3: Dc input/Dc output Ports

EMC EN61326:1997 + and A1:1998 + A2:2001

Immunity and Emissions requirements for electrical equipment for measurement, control and laboratory.

- EMC Emissions Table 4, Class B of EN61326
- EMC Immunity Table 1 of EN61326

Note: *I/O lines require shielded cables and these cables must be located on conductive cable trays or in conduits.*



Refer to the EMC and Safety installation considerations (Guidelines) of this manual for additional information.

7.2 FCC

This device complies with Part 15, Subpart B, Class B of the FCC rules.

Warranty/Disclaimer

NEWPORT Electronics, Inc. warrants this unit to be free of defects in materials and workmanship for a period of **one (1) year** from the date of purchase. In addition to NEWPORT's standard warranty period, NEWPORT Electronics will extend the warranty period for **one (1) additional year** if the warranty card enclosed with each instrument is returned to NEWPORT.

If the unit should malfunction, it must be returned to the factory for evaluation. NEWPORT's Customer Service Department will issue an Authorized Return (AR) number immediately upon phone or written request. Upon examination by NEWPORT, if the unit is found to be defective it will be repaired or replaced at no charge. NEWPORT's WARRANTY does not apply to defects resulting from any action of the purchaser, including but not limited to mishandling, improper interfacing, operation outside of design limits, improper repair, or unauthorized modification. This WARRANTY is VOID if the unit shows evidence of having been tampered with or shows evidence of being damaged as a result of excessive corrosion; or current, heat, moisture or vibration; improper specification; misapplication; misuse or other operating conditions outside of NEWPORT's control. Components which wear are not warranted, including but not limited to contact points, fuses, and triacs.

NEWPORT is pleased to offer suggestions on the use of its various products. However, NEWPORT neither assumes responsibility for any omissions or errors nor assumes liability for any damages that result from the use of its products in accordance with information provided by NEWPORT, either verbal or written. NEWPORT warrants only that the parts manufactured by it will be as specified and free of defects. NEWPORT MAKES NO OTHER WARRANTIES OR REPRESENTATIONS OF ANY KIND WHATSOEVER, EXPRESSED OR IMPLIED, EXCEPT THAT OF TITLE, AND ALL IMPLIED WARRANTIES INCLUDING ANY WARRANTY OF MERCHANTABILITY AND FITNESS FOR A PARTICULAR PURPOSE ARE HEREBY DISCLAIMED. LIMITATION OF LIABILITY: The remedies of purchaser set forth herein are exclusive and the total liability of NEWPORT with respect to this order, whether based on contract, warranty, negligence, indemnification, strict liability or otherwise, shall not exceed the purchase price of the component upon which liability is based. In no event shall NEWPORT be liable for consequential, incidental or special damages.

CONDITIONS: Equipment sold by NEWPORT is not intended to be used, nor shall it be used: (1) as a "Basic Component" under 10 CFR 21 (NRC), used in or with any nuclear installation or activity; or (2) in medical applications or used on humans. Should any Product(s) be used in or with any nuclear installation or activity, medical application, or used on humans, or misused in any way, NEWPORT assumes no responsibility as set forth in our basic WARRANTY / DISCLAIMER language, and additionally purchaser will indemnify NEWPORT and hold NEWPORT harmless from any liability or damage whatsoever arising out of the use of the Product(s) in such a manner.

Return Requests/Inquiries

Direct all warranty and repair requests/inquiries to the NEWPORT Customer Service Department. **BEFORE RETURNING ANY PRODUCT(S) TO NEWPORT, PURCHASER MUST OBTAIN AN AUTHORIZED RETURN (AR) NUMBER FROM NEWPORT'S CUSTOMER SERVICE DEPARTMENT (IN ORDER TO AVOID PROCESSING DELAYS).** The assigned AR number should then be marked on the outside of the return package and on any correspondence.

The purchaser is responsible for shipping charges, freight, insurance and proper packaging to prevent breakage in transit.

FOR **WARRANTY** RETURNS, please have the following information available **BEFORE** contacting NEWPORT:

1. P.O. number under which the product was **PURCHASED**,
2. Model and serial number of the product under warranty, and
3. Repair instructions and/or specific problems relative to the product.

FOR **NON-WARRANTY** REPAIRS, consult NEWPORT for current repair charges. Have the following information available **BEFORE** contacting NEWPORT:

1. P.O. number to cover the **COST** of the repair,
2. Model and serial number of product, and
3. Repair instructions and/or specific problems relative to the product.

NEWPORT's policy is to make running changes, not model changes, whenever an improvement is possible. This affords our customers the latest in technology and engineering.

NEWPORT is a registered trademark of NEWPORT Electronics, Inc.

© Copyright 2013 NEWPORT Electronics, Inc. All rights reserved. This document may not be copied, photocopied, reproduced, translated, or reduced to any electronic medium or machine-readable form, in whole or in part, without prior written consent of NEWPORT Electronics, Inc.

For immediate technical or application assistance please call:

1-800-6397678®
1-800-NEWPORT

Newport Electronics, Inc.

2229 South Yale Street • Santa Ana, CA • 92704 • U.S.A.

TEL: (714) 540-4914 • FAX: (203) 968-7311

Toll Free: 1-800-639-7678 • www.newportUS.com • e-mail: info@newportUS.com

ISO 9001 Certified

Newport Technologies, Inc.

976 Bergar • Laval (Quebec) • H7L 5A1 • Canada

TEL: (514) 335-3183 • FAX: (514) 856-6886

Toll Free: 1-800-639-7678 • www.newport.ca • e-mail: info@newport.ca

Newport Electronics, Ltd.

One Omega Drive • River Bend Technology Centre

Northbank, Irlam • Manchester M44 5BD • United Kingdom

Tel: +44 161 777 6611 • FAX: +44 161 777 6622

Toll Free: 0800 488 488 • www.newportuk.co.uk • e-mail: sales@newportuk.co.uk

Newport Electronics B.V. - Benelux

Managed by the United Kingdom Office

TEL: +31 20 3472121 • FAX: +31 20 6434643

Toll Free: 0800 0993344 • www.newport.nl • e-mail: info@newport.nl

Newport Electronics spol s.r.o.

Frystatska 184, 733 01 Karviná • Czech Republic

TEL: +420 59 6311899 • FAX: +420 59 6311114

Toll Free: 0800-1-66342 • www.newport.cz • e-mail: info@newport.cz

Newport Electronics GmbH

Daimlerstrasse 26 • D-75392 Deckenpfronn • Germany

TEL: 49 7056 9398-0 • FAX: 49 7056 9398-29

Toll Free: 0800 / 6397678 • www.newport.de • e-mail: sales@newport.de

Newport Electronique S.A.R.L. - France

Managed by the United Kingdom Office

TEL: 01 57 32 48 17 • FAX: 01 57 32 48 18

Toll Free: 0805 541 038 • www.newport.fr • e-mail: sales@newport.fr

Mexico and Latin America

FAX: 001 (203) 359-7807

TEL En Español: 001 (203) 359-7803

NEWPORTnetSM On-Line Service www.newportUS.com
--

Internet e-mail info@newportUS.com
--



NEWPORT Electronics, Inc.

M4051/N/0113