

Dual N-Channel 20 V (D-S) MOSFET

PRODUCT SUMMARY		
V_{DS} (V)	$R_{DS(on)}$ (Ω)	I_D (mA)
20	0.70 at $V_{GS} = 4.5$ V	600
	0.85 at $V_{GS} = 2.5$ V	500
	1.25 at $V_{GS} = 1.8$ V	350

FEATURES

- Halogen-free According to IEC 61249-2-21 Definition
- TrenchFET[®] Power MOSFET: 1.8 V Rated
- Very Small Footprint
- High-Side Switching
- Low On-Resistance: 0.7 Ω
- Low Threshold: 0.8 V (typ.)
- Fast Switching Speed: 10 ns
- 1.8 V Operation
- Gate-Source ESD Protected: 2000 V
- Compliant to RoHS Directive 2002/95/EC



RoHS
COMPLIANT
HALOGEN
FREE

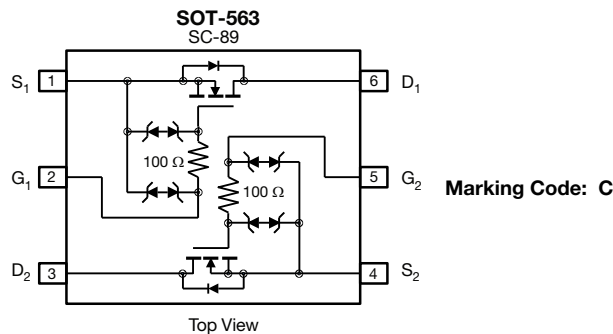

Ordering Information: Si1024X-T1-GE3 (Lead (Pb)-free and Halogen-free)

BENEFITS

- Ease in Driving Switches
- Low Offset (Error) Voltage
- Low-Voltage Operation
- High-Speed Circuits
- Low Battery Voltage Operation

APPLICATIONS

- Drivers: Relays, Solenoids, Lamps, Hammers, Displays, Memories
- Battery Operated Systems
- Power Supply Converter Circuits
- Load/Power Switching Cell Phones, Pages

ABSOLUTE MAXIMUM RATINGS ($T_A = 25$ °C, unless otherwise noted)					
Parameter	Symbol	5 s	Steady State	Unit	
Drain-Source Voltage	V_{DS}	20		V	
Gate-Source Voltage	V_{GS}	± 6			
Continuous Drain Current ($T_J = 150$ °C) ^a	I_D	$T_A = 25$ °C	515	485	mA
		$T_A = 85$ °C	370	350	
Pulsed Drain Current ^b	I_{DM}	650			
Continuous Source Current (Diode Conduction) ^a	I_S	450	380		
Maximum Power Dissipation ^a	P_D	$T_A = 25$ °C	280	250	mW
		$T_A = 85$ °C	145	130	
Operating Junction and Storage Temperature Range	T_J, T_{stg}	- 55 to 150		°C	
Gate-Source ESD Rating (HBM, Method 3015)	ESD	2000		V	

Notes:

a. Surface mounted on FR4 board.

b. Pulse width limited by maximum junction temperature.

SPECIFICATIONS ($T_J = 25\text{ }^\circ\text{C}$, unless otherwise noted)

Parameter	Symbol	Test Conditions	Min.	Typ.	Max.	Unit
Static						
Gate Threshold Voltage	$V_{GS(th)}$	$V_{DS} = V_{GS}$, $I_D = 250\text{ }\mu\text{A}$	0.45		0.9	V
Gate-Body Leakage	I_{GSS}	$V_{DS} = 0\text{ V}$, $V_{GS} = \pm 4.5\text{ V}$		± 0.5	± 1	μA
Zero Gate Voltage Drain Current	I_{DSS}	$V_{DS} = 20\text{ V}$, $V_{GS} = 0\text{ V}$		0.3	100	nA
		$V_{DS} = 20\text{ V}$, $V_{GS} = 0\text{ V}$, $T_J = 85\text{ }^\circ\text{C}$			5	μA
On-State Drain Current ^a	$I_{D(on)}$	$V_{DS} = 5\text{ V}$, $V_{GS} = 4.5\text{ V}$	700			mA
Drain-Source On-State Resistance ^a	$R_{DS(on)}$	$V_{GS} = 4.5\text{ V}$, $I_D = 600\text{ mA}$		0.41	0.70	Ω
		$V_{GS} = 2.5\text{ V}$, $I_D = 500\text{ mA}$		0.53	0.85	
		$V_{GS} = 1.8\text{ V}$, $I_D = 350\text{ mA}$		0.70	1.25	
Forward Transconductance ^a	g_{fs}	$V_{DS} = 10\text{ V}$, $I_D = 400\text{ mA}$		1		S
Diode Forward Voltage ^a	V_{SD}	$I_S = 150\text{ mA}$, $V_{GS} = 0\text{ V}$		0.8	1.2	V
Dynamic^b						
Total Gate Charge	Q_g	$V_{DS} = 10\text{ V}$, $V_{GS} = 4.5\text{ V}$, $I_D = 250\text{ mA}$		750		pC
Gate-Source Charge	Q_{gs}			75		
Gate-Drain Charge	Q_{gd}			225		
Turn-On Time	$t_{d(on)}$	$V_{DD} = 10\text{ V}$, $R_L = 47\text{ }\Omega$ $I_D \approx 200\text{ mA}$, $V_{GEN} = 4.5\text{ V}$, $R_g = 10\text{ }\Omega$		10		ns
Turn-Off Time	$t_{d(off)}$			36		

Notes:

- a. Pulse test; pulse width $\leq 300\text{ }\mu\text{s}$, duty cycle $\leq 2\%$.
b. Guaranteed by design, not subject to production testing.

Stresses beyond those listed under "Absolute Maximum Ratings" may cause permanent damage to the device. These are stress ratings only, and functional operation of the device at these or any other conditions beyond those indicated in the operational sections of the specifications is not implied. Exposure to absolute maximum rating conditions for extended periods may affect device reliability.

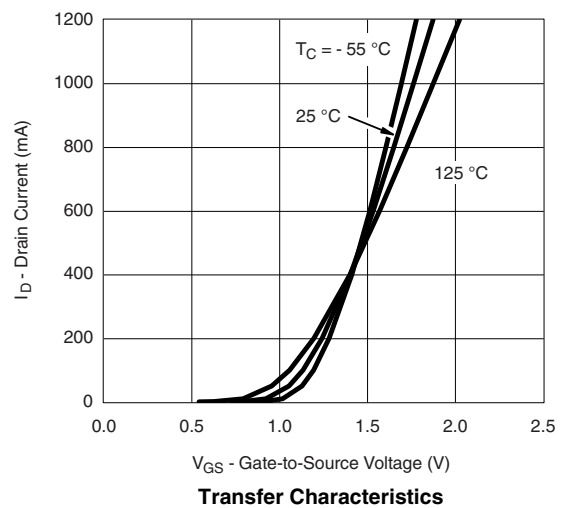
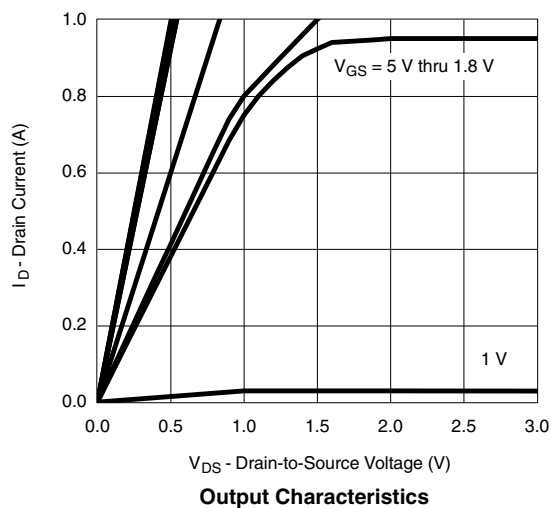
TYPICAL CHARACTERISTICS ($T_A = 25\text{ }^\circ\text{C}$, unless otherwise noted)

TYPICAL CHARACTERISTICS ($T_A = 25^\circ\text{C}$, unless otherwise noted)

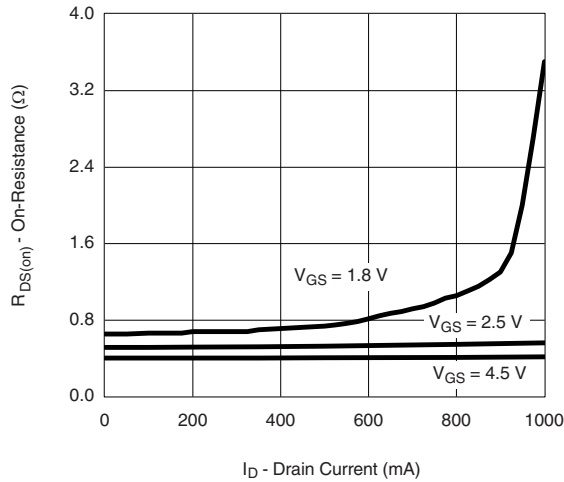

On-Resistance vs. Drain Current

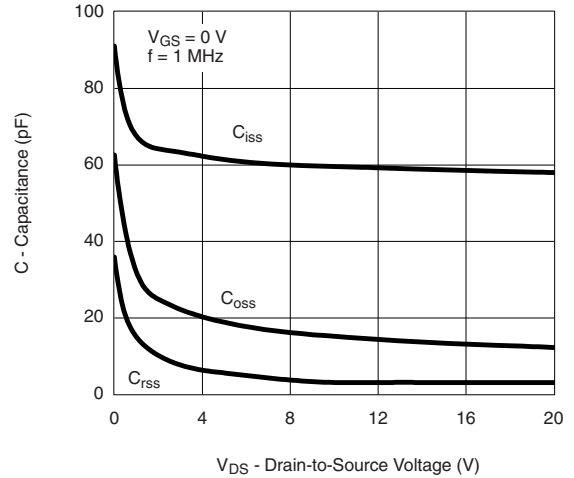

Capacitance

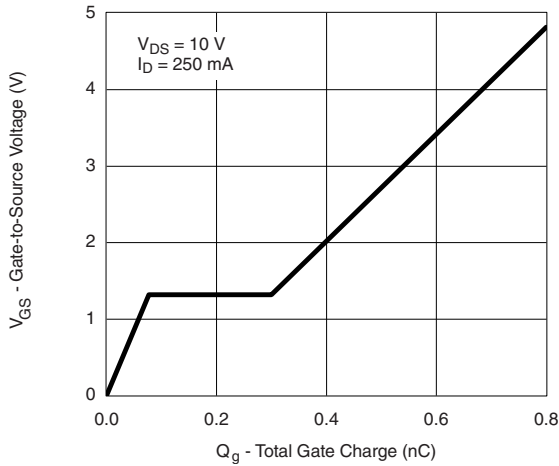

Gate Charge

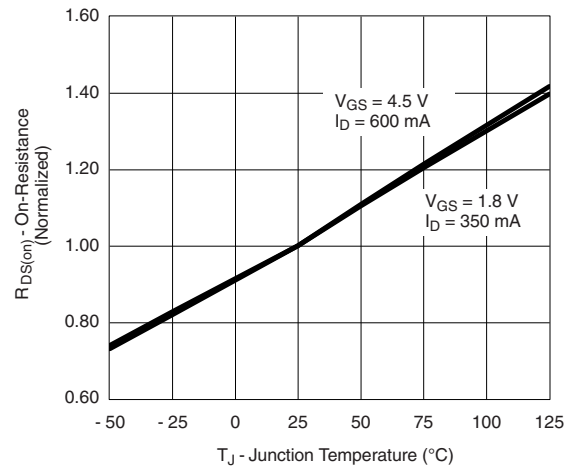

On-Resistance vs. Junction Temperature

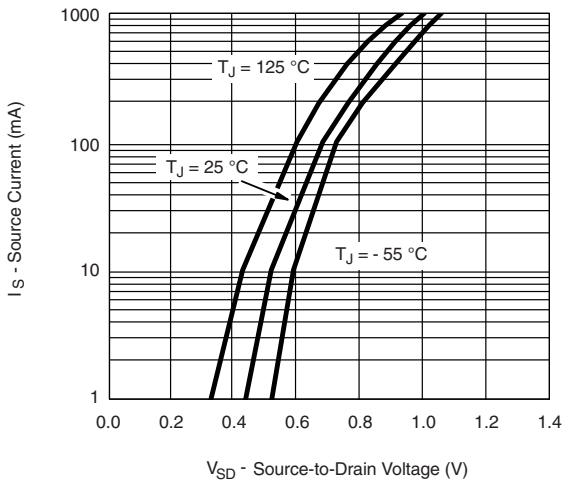

Source-Drain Diode Forward Voltage

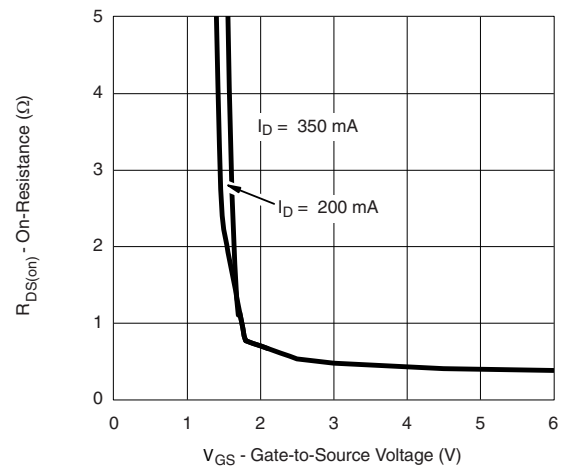

On-Resistance vs. Gate-to-Source Voltage

TYPICAL CHARACTERISTICS ($T_A = 25\text{ }^\circ\text{C}$, unless otherwise noted)

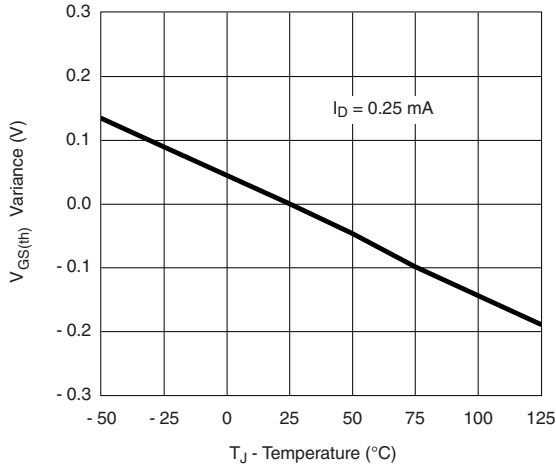

Threshold Voltage Variance vs. Temperature

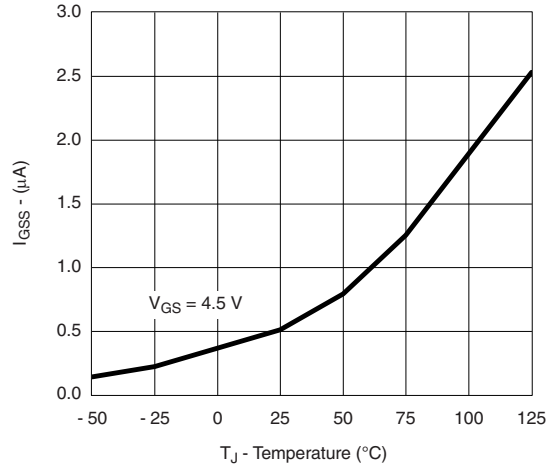

I_{GSS} vs. Temperature

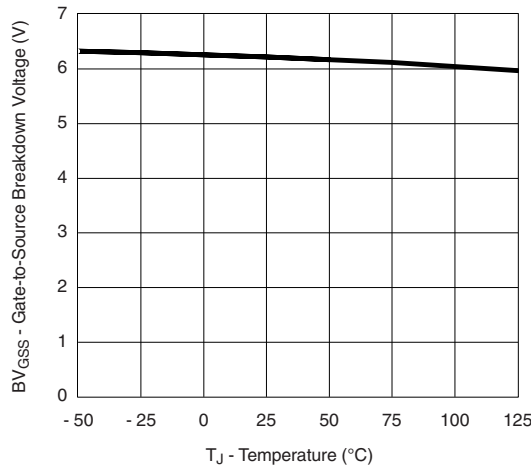

BV_{GSS} vs. Temperature

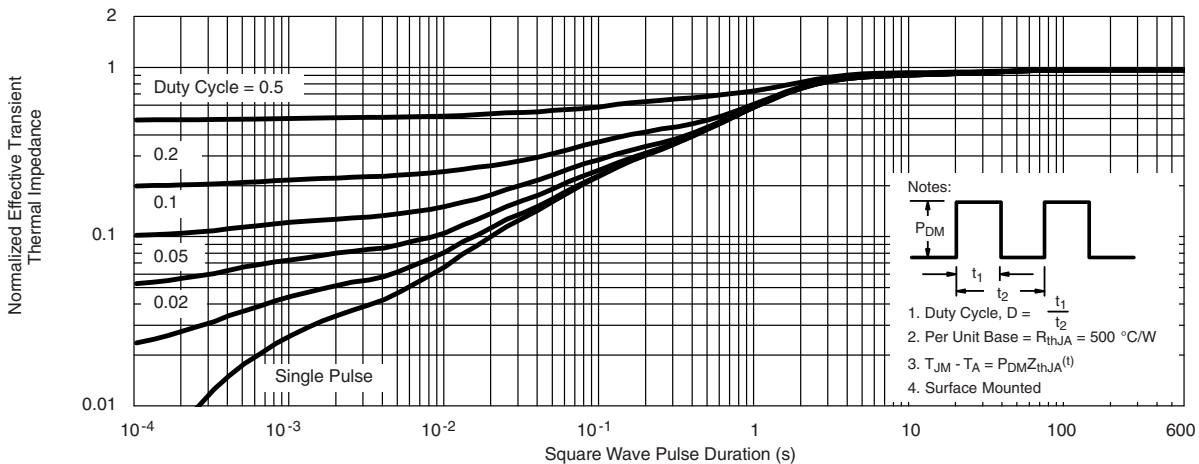

Normalized Thermal Transient Impedance, Junction-to-Ambient

Vishay Siliconix maintains worldwide manufacturing capability. Products may be manufactured at one of several qualified locations. Reliability data for Silicon Technology and Package Reliability represent a composite of all qualified locations. For related documents such as package/tape drawings, part marking, and reliability data, see www.vishay.com/ppg?71170.

SC-89 6-Leads (SOT-563F)



Notes

- Dimensions in millimeters.
- Dimension D does not include mold flash, protrusions or gate burrs. Mold flash, protrusions or gate burrs shall not exceed 0.15 mm per dimension E1 does not include interlead flash or protrusion, interlead flash or protrusion shall not exceed 0.15 mm per side.
- Dimensions D and E1 are determined at the outmost extremes of the plastic body exclusive of mold flash, the bar burrs, gate burrs and interlead flash, but including any mismatch between the top and the bottom of the plastic body.
- Datums A, B and D to be determined 0.10 mm from the lead tip.
- Terminal numbers are shown for reference only.
- These dimensions apply to the flat section of the lead between 0.08 mm and 0.15 mm from the lead tip.

DIM.	MILLIMETERS		
	MIN.	NOM.	MAX.
A	0.56	0.58	0.60
A1	0	0.02	0.10
b	0.15	0.22	0.30
c	0.10	0.14	0.18
D	1.50	1.60	1.70
E	1.50	1.60	1.70
E1	1.15	1.20	1.25
e	0.45	0.50	0.55
e1	0.95	1.00	1.05
L	0.25	0.35	0.50
L1	0.10	0.20	0.30

C14-0439-Rev. C, 11-Aug-14
DWG: 5880

RECOMMENDED MINIMUM PADS FOR SC-89: 6-Lead



Recommended Minimum Pads
Dimensions in Inches/(mm)

[Return to Index](#)



Disclaimer

ALL PRODUCT, PRODUCT SPECIFICATIONS AND DATA ARE SUBJECT TO CHANGE WITHOUT NOTICE TO IMPROVE RELIABILITY, FUNCTION OR DESIGN OR OTHERWISE.

Vishay Intertechnology, Inc., its affiliates, agents, and employees, and all persons acting on its or their behalf (collectively, "Vishay"), disclaim any and all liability for any errors, inaccuracies or incompleteness contained in any datasheet or in any other disclosure relating to any product.

Vishay makes no warranty, representation or guarantee regarding the suitability of the products for any particular purpose or the continuing production of any product. To the maximum extent permitted by applicable law, Vishay disclaims (i) any and all liability arising out of the application or use of any product, (ii) any and all liability, including without limitation special, consequential or incidental damages, and (iii) any and all implied warranties, including warranties of fitness for particular purpose, non-infringement and merchantability.

Statements regarding the suitability of products for certain types of applications are based on Vishay's knowledge of typical requirements that are often placed on Vishay products in generic applications. Such statements are not binding statements about the suitability of products for a particular application. It is the customer's responsibility to validate that a particular product with the properties described in the product specification is suitable for use in a particular application. Parameters provided in datasheets and/or specifications may vary in different applications and performance may vary over time. All operating parameters, including typical parameters, must be validated for each customer application by the customer's technical experts. Product specifications do not expand or otherwise modify Vishay's terms and conditions of purchase, including but not limited to the warranty expressed therein.

Except as expressly indicated in writing, Vishay products are not designed for use in medical, life-saving, or life-sustaining applications or for any other application in which the failure of the Vishay product could result in personal injury or death. Customers using or selling Vishay products not expressly indicated for use in such applications do so at their own risk. Please contact authorized Vishay personnel to obtain written terms and conditions regarding products designed for such applications.

No license, express or implied, by estoppel or otherwise, to any intellectual property rights is granted by this document or by any conduct of Vishay. Product names and markings noted herein may be trademarks of their respective owners.

Material Category Policy

Vishay Intertechnology, Inc. hereby certifies that all its products that are identified as RoHS-Compliant fulfill the definitions and restrictions defined under Directive 2011/65/EU of The European Parliament and of the Council of June 8, 2011 on the restriction of the use of certain hazardous substances in electrical and electronic equipment (EEE) - recast, unless otherwise specified as non-compliant.

Please note that some Vishay documentation may still make reference to RoHS Directive 2002/95/EC. We confirm that all the products identified as being compliant to Directive 2002/95/EC conform to Directive 2011/65/EU.

Vishay Intertechnology, Inc. hereby certifies that all its products that are identified as Halogen-Free follow Halogen-Free requirements as per JEDEC JS709A standards. Please note that some Vishay documentation may still make reference to the IEC 61249-2-21 definition. We confirm that all the products identified as being compliant to IEC 61249-2-21 conform to JEDEC JS709A standards.