

IEC Appliance Inlet C14 with Circuit Breaker TA35 2-pole

V-Lock



C14

70° C



Description

- Panel Mount:
Snap-in version from front side
- 2 Functions:
Appliance Inlet, Protection class I, Circuit breaker type TA35, 2-pole
- Quick connect terminal 6.3 x 0.8 mm

Approvals

- VDE Certificate Number: 40023066
- UL File Number: E96454

Characteristics

- Unwired
- Switch non-illuminated or illuminated
- Suitable for use in equipment according to IEC/UL 60950

Other versions on request

- Pre-wired version
- Quick connect terminals 4.8 x 0.8 mm
- Protection class II, 70°C

References

Alternative: version for 16 A (20 A)
Substitute for type 7764

Weblinks

[pdf-datasheet](#), [html-datasheet](#), [General Product Information](#), [Approvals](#), [CE declaration of conformity](#), [RoHS](#), [CHINA-RoHS](#), [REACH](#), [Mating Connectors](#), [e-Shop](#), [SCHURTER-Stock-Check](#), [Distributor-Stock-Check](#), [CAD-Drawings](#), [Accessories](#), [Detailed request for product](#)

Newly available variants corresponding to V-Lock mating cordset. The connector is equipped with a notch intended for use with the latching cordset. The cord latching system prevents against accidental removal of the cordset.

Technical Data

Ratings IEC	10A / 250VAC; 50Hz	Appliance Inlet	C14 acc. to IEC 60320
Ratings UL/CSA	15A / 250VAC; 60Hz		UL 498, CSA C22.2 no. 42 (for cold conditions) pin-temperature 70 °C, 10A, Protection Class I
Dielectric Strength	> 2.5kVAC between L-N > 3kVAC between L/N-PE (1 min/50Hz)	Circuit Breakers	Acc. IEC/EN 60934, UL 1077, CSA 22.2 no. 235 2-pole rocker switch, illuminated or non-illuminated. Conditional short circuit Inc: 2000 A
Allowable Operation Temp.	-25 °C to 60 °C		
Degree of Protection	from front side IP 40 acc. to IEC 60529		
Protection Class	Suitable for appliances with protection class I acc. to IEC 61140		
Terminal	Quick connect terminals 6.3 x 0.8 mm		
Panel Thickness s	Snap-in 1.5/2/2.5 mm		
Material: Housing	Thermoplastic, black, UL 94V-0		

Dimensions

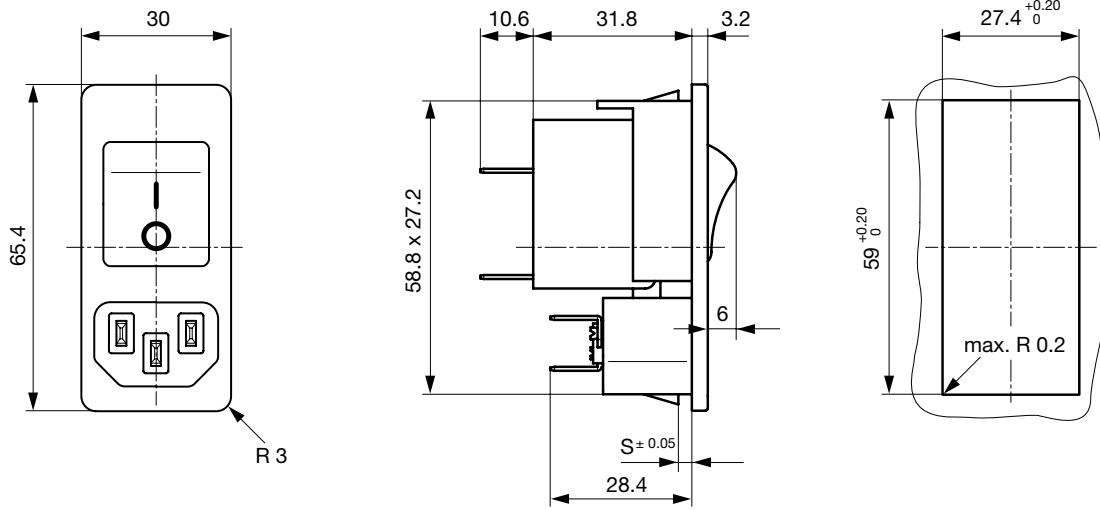

Diagrams

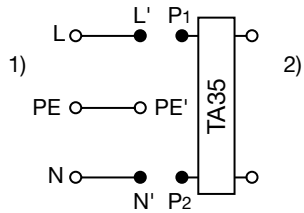

- 1) Line
- 2) Load

ORDER CODE

Table 1 Selection for type TA35

Order example

Number of switched poles Number of protected poles		2-pole	
		1	2
Switch	without illumination	CBT	CBD
Switch	illuminated 240 V 120 V	C12 C14	C32 C34

Other versions on request

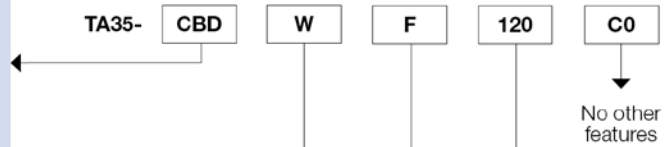

Colours

	Switch front	Rocker	
		non-illuminated	illuminated
W	black	white	–
B	black	black	–
3	black	–	red transparent
4	black	–	green transparent
6	black	–	orange transparent

Other colours on request

Rocker legend

	Surface	Illustration		Colour of print
F	embossed	–	o	
H	printed	ON	OFF	white
K	printed	ON	OFF	black
L	printed	–	o	white
M	printed	–	o	black

Other legends on request

Position of the rocker legend e.g. F

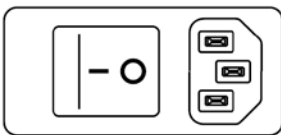

Rated current I_n (A)

I_n	Code	I_n	Code
1,0	J10	8,0	080
2,0	J20	10,0	100
4,0	040	12,0	120*
5,0	050	15,0	150*
6,0	060		

Other rated currents on request *) UL / CSA only

Technical data (continued)

Circuit breaker

Tripping characteristics

$I_n < 3 A$

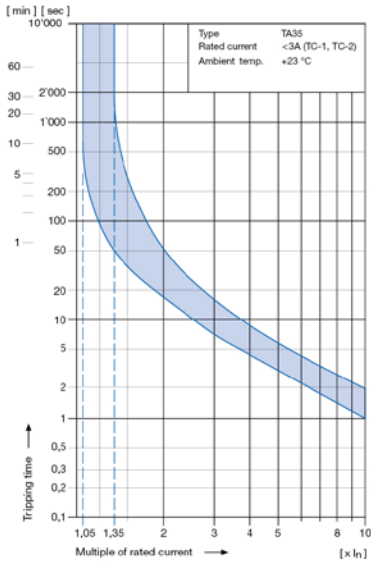

Tripping characteristics

$I_n \ge 3 \dots 15 A$

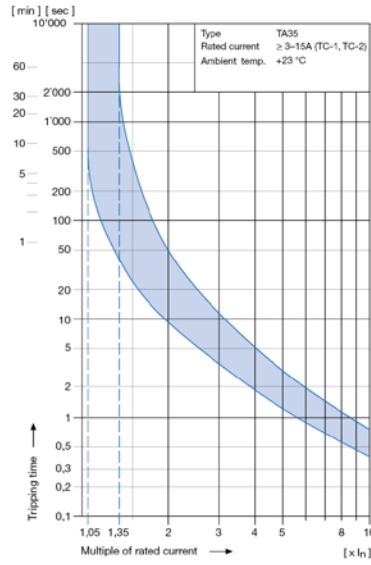

The above tripping characteristics apply to symmetrical overloads on the two poles.

At asymmetric overloads on two pole types the tripping current will be increased by factor **1.05** (TC-2).

Effect of ambient temperature

The unit is calibrated for an ambient temperature of +23 °C. To determine the rated current for lower or higher ambient temperature, use a correction factor from the table below.

* Temperature must be measured at the rear of the breaker next to the terminals after equipment operating temperature has been reached.

* Ambient temperature [°C]	Correction factor
-25	0.79
-20	0.81
0	0.90
+23	1.00
+40	1.03
+50	1.04
+60	1.06

Example:

Rated current at +23 °C 10 A
 Ambient temperature +60 °C
 Correction factor 1.06
 Chosen rated current at +60 °C
 ambient temperature: **10 A x 1.06 = 10.6 A**

Order code (Order example)

Type	Order code TA35		
6135	C B D W F 1 2 0 C 0	. 0 2 1 0 . 2 1	<p>Specials 21 V-Lock-Notch</p> <p>Wiring 1 wired 0 unwired</p> <p>Terminals 1 Quick connect 6.3 x 0.8 mm</p> <p>Mounting 2 Snap-in s = 1.5 mm 3 Snap-in s = 2.0 mm 4 Snap-in s = 2.5 mm</p> <p>0 Protection class 1</p>

see table 1

Please note that Schurter will establish an internal part number for logistics use in addition to the order code. The format of this internal part number is, for example: 6135.xxxx.xxxx

Packaging unit 40 Pcs

Accessories

Description

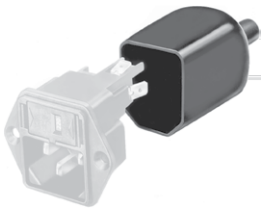

Assorted Covers
Rear Cover



Cord retaining kits
Cord retaining strain relief

Mating Outlets/Connectors

Category / Description



Appliance Outlet Overview complete

IEC Appliance Outlet F, Screw-on Mounting, Front Side, Solder Terminal	4787
IEC Appliance Outlet F, Snap-in Mounting, Front Side, Solder or Quick-connect Terminal	4788

Appliance Outlet further types to 6135

Connector Overview complete



IEC Connector C15A, Rewireable, Straight	0102
IEC Connector C15A, Rewireable, Straight	0102-G
IEC Connector C15A, Rewireable, Angled	0112
IEC Connector C13, Rewireable, Angled	4012
IEC Connector C13, Rewireable, Straight	4022

Connector further types to 6135

Mating Outlets/Connectors shuttered



Power Cord Overview complete

Overview Power Supply Cord with IEC Connector C13, V-Lock, straight	VAC13KS
---	---------

Power Cord further types to 6135