

iProx



E57P Performance



AccuProx



E56 Pancake



Nonmetallic Tubular



E52 Cube Style



E51, Factory Sealed



3.0	Introduction	
	Quick Reference Guide	V8-T3-2
3.1	iProx Sensors	
	Product Description	V8-T3-11
3.2	E57P Performance Series Sensors	
	Product Description	V8-T3-18
3.3	E57PS Performance Short Body Sensors	
	Product Description	V8-T3-24
3.4	E57G General Purpose Proximity Sensors	
	Product Description	V8-T3-29
3.5	E57 Two-Wire (AC, AC/DC, DC) Proximity Sensors	
	Product Description	V8-T3-35
3.6	AccuProx Analog Sensors	
	Product Description	V8-T3-49
3.7	Ferrous Only Tubular Sensors	
	Product Description	V8-T3-55
3.8	Metal Face Sensors	
	Product Description	V8-T3-58
3.9	High Current Output Sensors	
	Product Description	V8-T3-62
3.10	Small Diameter (4, 5, 6.5, 8 mm) Sensors	
	Product Description	V8-T3-65
3.11	E56 Pancake Sensors	
	Product Description	V8-T3-71
3.12	Nonmetallic Tubular Sensors	
	Product Description	V8-T3-76
3.13	E52 Cube Style Sensors	
	Product Description	V8-T3-79
3.14	E52 Rectangular Style Sensors	
	Product Description	V8-T3-83
3.15	E55 Limit Switch Style Sensors with Nonmetallic Housings	
	Product Description	V8-T3-86
3.16	E51 Modular Limit Switch Style Sensors	
	Product Description	V8-T3-88
3.17	E51 Limit Switch Style, Factory Sealed 6P+ Sensors	
	Product Description	V8-T3-97



Unless otherwise noted, the products contained in this section should not be used for functional safety applications. These products were not designed or tested to IEC 60947-5-3 or recommended for functional safety.

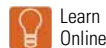

For Customer Service in the U.S. call 1-877-ETN CARE (386-2273),
in Canada call 1-800-268-3578.
For Application Assistance in the U.S. and Canada
call 1-800-426-9184.

Quick Reference Guide

Inductive Proximity Sensors

3

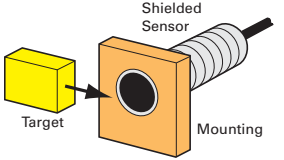
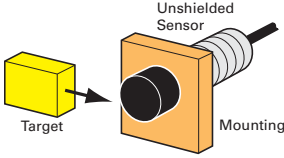
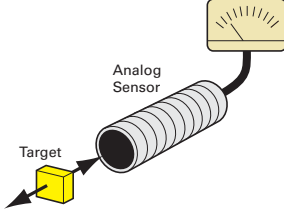
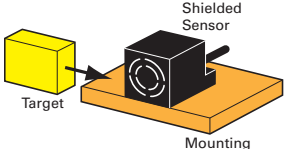
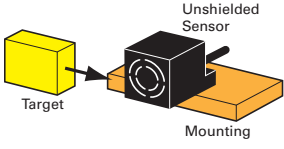
Sensing Application	Sensing Style	Size	Max Range	Product Family	Page
	Shielded tubular	4 mm	0.8 mm	Small Diameter Sensors	V8-T3-65
		5 mm	0.8 mm	Small Diameter Sensors	V8-T3-65
		6.5 mm	1 mm	Small Diameter Sensors	V8-T3-65
		8 mm	3 mm	Small Diameter Sensors	V8-T3-65
		12 mm	4 mm	iProx™ Sensors	V8-T3-11
			4 mm	E57P Performance Sensors	V8-T3-18, V8-T3-24
			4 mm	E57G General Purpose Sensors	V8-T3-29
		18 mm	8 mm	iProx Sensors	V8-T3-11
			8 mm	E57P Performance Sensors	V8-T3-18, V8-T3-24
			8 mm	E57G General Purpose Sensors	V8-T3-29
30 mm	15 mm	iProx Sensors	V8-T3-11		
	15 mm	E57P Performance Sensors	V8-T3-18, V8-T3-24		
	15 mm	E57G General Purpose Sensors	V8-T3-29		
	Unshielded tubular	6.5 mm	2 mm	Small Diameter	V8-T3-65
		8 mm	6 mm	Small Diameter	V8-T3-65
		12mm	10 mm	iProx Sensors	V8-T3-11
			8 mm	E57P Performance Sensors	V8-T3-18, V8-T3-24
			8 mm	E57G General Purpose Sensors	V8-T3-29
		18 mm	18 mm	iProx Sensors	V8-T3-11
			12 mm	E57P Performance Sensors	V8-T3-18, V8-T3-24
			12 mm	E57G General Purpose Sensors	V8-T3-29
		30 mm	29 mm	iProx Sensors	V8-T3-11
			22 mm	E57P Performance Sensors	V8-T3-18, V8-T3-24
22 mm	E57G General Purpose Sensors		V8-T3-29		
	Analog tubular	12 mm	8 mm	AccuProx™ Analog Sensors	V8-T3-49
		18 mm	15 mm	AccuProx Analog Sensors	V8-T3-49
		30 mm	25 mm	AccuProx Analog Sensors	V8-T3-49
	Shielded cube	40 x 40 x 40 mm	20 mm	E52 Cube Style Sensors	V8-T3-79
	Unshielded cube	40 x 40 x 40 mm	40 mm	E52 Cube Style Sensors	V8-T3-79

Inductive Proximity Sensors, continued

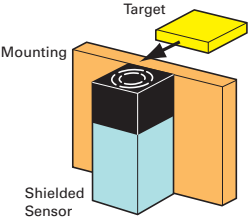
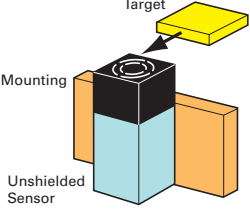
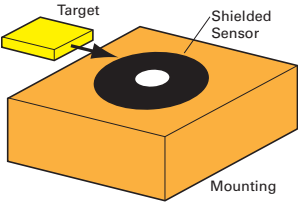
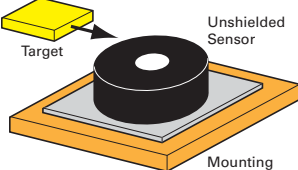
Sensing Application	Sensing Style	Size	Max Range	Product Family	Page
	Shielded limit switch	118 x 40 x 40 mm 114 x 39 x 38.4 mm	13 mm	E51 Modular Limit Switch Style Sensors E51 Limit Switch Style, Factory Sealed 6P+ Sensors E55 Limit Switch Style Sensors with Nonmetallic Housings	V8-T3-88, V8-T3-97
	Unshielded limit switch	118 x 40 x 40 mm 114 x 39 x 38.4 mm	24 mm	E51 Series E55 Series	V8-T3-88, V8-T3-97
	Shielded pancake	79 x 79 x 39 mm	40 mm	E56 Series	V8-T3-71
	Unshielded pancake	79 x 79 x 39 mm 110 x 110 x 41 mm 171.5 x 171.5 x 67.5 mm	100 mm	E56 Series	V8-T3-71

Technical Reference

Inductive Proximity Sensors

3



General

There are a number of factors which should be considered when applying induction proximity sensors. A detailed discussion of these factors can be found on **Page V8-T12-4**. Presented below are a few of the more important considerations for quick reference.

Mounting

Inductive proximity sensors are available in two classifications: shielded (also known as embeddable or flush mountable) and unshielded (non-embeddable or non-flush mountable). What these terms refer to is the distance to surrounding metal that the device can be mounted. In the case of a shielded sensor the device can be mounted with the sensor completely surrounded by metal.

In the case of an unshielded sensor, a metal free zone must be provided when mounting the sensor. The size of the metal free zone is dependent on both the size of the sensor and the type of sensing range it has, for example, standard or extended.

Mounting Ranges

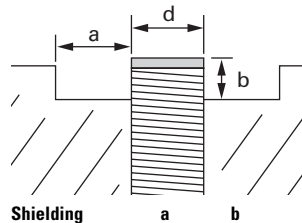

Shielding	a	b
Standard Range		
Shielded	0	0
Unshielded	2 x Sn	Cap height
Extended Range		
Semi-shielded	Sn	d
Non-embeddable	2 x Sn	Cap height

Where **a** and **b** are the metal free dimensions.

When mounting the sensors, do not exceed the following recommended torque specifications.

Torque Specifications

	Stainless Steel	Nickel-Plated Brass
12 mm Diameter		
	35 lb-in (4.0 Nm)	20 lb-in (2.3 Nm)
18 mm Diameter		
	70 lb-in (7.9 Nm)	70 lb-in (7.9 Nm)
30 mm Diameter		
	70 lb-in (7.9 Nm)	70 lb-in (7.9 Nm)

Extended Range Sensors

Extended range proximity sensors by Eaton’s Electrical Sector offer sensing distances almost three times greater than conventional devices. They are available in semi-shielded designs: mounted similar to an embeddable sensor—and non-embeddable designs requiring more metal free zone area than conventional unshielded sensors. All are available in a variety of circuits and terminations.

Target Material

When manufacturers of inductive proximity sensors state the sensing range of their devices, they are usually based upon a ferrous target made of carbon-rolled steel (IE FE 360) defined by ISO630. For example, in this product guide the E57P-18SPN5-C2 has a sensing range of 5 mm based upon a target of mild steel.

Sensing ranges to targets made of non-ferrous metals have to have a correction factor applied as listed in the table below. To use this table, multiply the sensing distance of the device by the factor given.

Example: The E57P-18SPN5-C2 has a sensing range of 5 mm. When used to sense a brass target, the sensing range becomes 2.25 mm (5 mm x 0.45).

Table of Correction Factors

Multiply sensing range of device by factor given below.

Correction Factors

Target	Sensor Size				Limit Switch
	4–8 mm	12 mm	18 mm	30 mm	
Stainless steel 400	0.90	0.90	1.0	1.0	1.0
Stainless steel 300	0.65	0.70	0.70	0.75	0.85
Brass	0.35	0.45	0.45	0.45	0.5
Aluminum	0.35	0.40	0.45	0.40	0.47
Copper	0.30	0.25	0.35	0.30	0.40

Target Size

Often overlooked when applying sensors is the fact that the manufacturer’s stated sensing ranges are also dependent upon target size. The table below reflects the standard target sizes which were used to determine sensing ranges.

If targets are the same size or greater than standard, no reduction in sensing distance will occur. However, a smaller target size will result in a decrease in sensing range.

A general rule of thumb is that the target size shall be three times the range or the size of the sensor face, whichever is larger.

Standard Target Size ^①

Target	Standard Sensing Range		Extended Sensing Range	
	Shielded Devices	Unshielded Devices	Semi-Shield Devices	Non-Embeddable Devices
4 mm	4 mm square	4 mm square	—	—
5 mm	5 mm square	5 mm square	—	—
6.5 mm	6.5 mm square	6.5 mm square	—	—
8 mm	8 mm square	8 mm square	—	—
12 mm	12 mm square	12 mm square	18 mm square	30 mm square
18 mm	18 mm square	24 mm square	36 mm square	60 mm square
30 mm	30 mm square	45 mm square	66 mm square	—
Limit switch	45 mm square	72 mm square	—	—

Note

^① Targets are 1 mm thick.

Product Selection Guide

3

iProx



Page V8-T3-11

Overview

Designed to be the highest performing tubular inductive sensor. Standard features include extended sensing ranges, high noise-immunity, extreme durability and includes Autoconfigure Technology. Advanced features include output delay, speed detection and cloning with ProxView Software.

Applications

Automotive, machine tool, material handling where high sensing performance and inventory consolidation is a priority.

Product Features

Auto-configure technology automatically detects a sinking (NPN) or sourcing (PNP) connection and switches the sensor accordingly, without any user intervention. Optional computer programming cable and Windows-based ProxView configuration software makes it easy to customize sensors.

Clone the sensor to match the characteristics of more than 4,800 competitive models, or configure it to match your specific application needs.

Advanced programmable features such as dual outputs, output delay, speed detection and more.

Technical Data and Specifications

Current ratings—

AC: 250 mA

DC: 300 mA

Enclosure ratings—

NEMA® 4, 4X, 6, 6P, 12, 13

IEC IP67, IP69K

Construction—

Stainless steel

Approvals

cUL® Listed



E57P Performance Series



Page V8-T3-18

Overview

High performance inductive sensors. Extended and standard ranges available.

Applications

Automotive, machine tool, material handling where high sensing performance and inventory consolidation is a priority.

Product Features

12, 18 and 30 mm diameters

Three-wire DC sensors

360° LED indicators standard

NO or NC outputs

Short-circuit protection

Resettable short-circuit protected and reverse polarity on select models

Robust stainless steel tubes, shock-resistant front caps, polycarbonate end bells, and impact-absorbing potting compound are resistant to physical and environmental abuse in high temperature, high pressure washdown and high shock and vibration applications.

Technical Data and Specifications

Current ratings—

DC: 300 mA

Enclosure ratings—IP67, IP69K; NEMA 4, 4X, 6, 6P

Construction—

Stainless steel housing and nuts

Approvals

CE

cULus Listed



E57PS Performance Short Body



Page V8-T3-24

Overview

High performance inductive sensors with the ability to fit into tighter spaces.

Applications

Automotive, machine tool, material handling where high sensing performance and inventory consolidation is a priority.

Product Features

12, 18 and 30 mm diameters

Three-wire DC sensors

360° LED indicators standard

NO or NC outputs

Short-circuit protection

Resettable short-circuit protected and reverse polarity on select models

Robust stainless steel tubes, shock-resistant front caps, polycarbonate end bells, and impact-absorbing potting compound are resistant to physical and environmental abuse in high temperature, high pressure washdown and high shock and vibration applications.

Technical Data and Specifications

Current ratings—

DC: 300 mA

Enclosure ratings—IP67, IP69K; NEMA 4, 4X, 6, 6P

Construction—

Stainless steel housing and nuts

Approvals

CE

cULus Listed



E57G General Purpose



Page V8-T3-29

Overview

This full-line, tubular proximity sensor family provides a cost-effective solution for high volume OEM use.

Applications

Machine tool detection, press applications, cam detection, material handling, valve and shaft position, automotive assembly.

Product Features

12, 18 and 30 mm diameters

Three-wire DC sensors

360° LED indicators standard

NO or NC outputs

Short-circuit protection

Resettable short-circuit protected and reverse polarity on select models

Robust stainless steel tubes, shock-resistant front caps, polycarbonate end bells, and impact-absorbing potting compound are resistant to physical and environmental abuse in high temperature, high pressure washdown and high shock and vibration applications.

Technical Data and Specifications

Current ratings—

DC: 100 mA

Enclosure ratings—IP67; NEMA 4, 4X, 6, 6P

Construction—

Stainless steel housing and nickel-brass nuts

Approvals

CE

cULus Listed



E57 Two-Wire (AC, AC/DC, DC) Proximity



Page V8-T3-35

Overview

Various models available in two-wire configurations:
 Stainless steel (AC, AC/DC)
 Stainless steel short body (AC, AC/DC)
 Nickel-brass (AC, DC)

Applications

Machine tool detection, press applications, cam detection, material handling, valve and shaft position, automotive assembly.

Product Features

12, 18 and 30 mm diameters
 Two-wire AC, AC/DC, DC
 Shielded and unshielded models
 Standard and extended ranges
 LED indicators
 Cable and micro-connector
 NO or NC outputs

Technical Data and Specifications

Stainless steel:
 Current ratings—
 500 mA maximum
 Enclosure ratings—IP67, IP69K;
 NEMA 4, 4X, 6, 6P, 12, 13
 Nickel-Brass:
 Current ratings—
 200 mA (AC); 100 mA (DC)
 Enclosure ratings—
 IP69K, IP67

Approvals

cULus (Stainless Steel)
 cCSAus (Nickel-Brass)
 CE (SS: AC/DC only, NiBr: DC only)



AccuProx



Page V8-T3-45

Overview

AccuProx sensors feature analog outputs that change linearly as the target moves closer or further from the sensor face.

Applications

Part positioning, distance, size and thickness measurement, general inspection and error proofing (such as material imperfection or blemish detection), eccentricity or absolute angle detection, identification of different metals

Product Features

Extended linear sensing range of up to 25 mm—three times longer than standard tubular analog inductive sensors
 Outputs available in current (4–20 or 0–20 mA) and voltage (0–10 V)
 High output resolution and repeatability for applications requiring precision sensing performance
 Robust stainless steel barrel, shock-resistant front cap, polycarbonate end bell and impact-absorbing potting compound
 Ideal for extreme temperature or high pressure washdown environments

Technical Data and Specifications

Current ratings—
 0–10 Vdc, 0–20 mA, 4–20 mA
 Enclosure ratings—
 NEMA 4, 4X, 6, 6P, 13
 Construction—
 Stainless steel

Approvals

cUL Listed



Ferrous Only Tubular



Page V8-T3-55

Overview

Sensors designed to detect only ferrous metals (steel/iron).

Applications

Workcell applications, automotive and aircraft production.

Product Features

18 mm diameters
 Two-wire AC or three-wire DC
 NO or NC outputs
 Micro- and mini-pin terminations
 LED indicators

Technical Data and Specifications

Current ratings—
 AC: 500 mA continuous
 DC: 200 mA continuous
 Enclosure ratings—
 NEMA 4, 4X, 6, 6P, 12, 13
 IEC IP67
 Construction—
 Stainless steel

Approvals

UL Listed
 CSA Certified



Metal Face



Page V8-T3-58

Overview

Tough sensors with thick stainless steel sensing faces and barrels.

Applications

Metal cutting operations where damage to sensor face could occur.

Product Features

12, 18 and 30 mm diameters
 Two-wire AC or three-wire DC
 20 mil thick stainless steel face
 303 stainless steel barrel
 LED indicator
 2-meter cable, micro- and mini-pin connections

Technical Data and Specifications

Current ratings—
 AC: 500 mA continuous
 DC: 200 mA continuous
 Enclosure ratings—
 NEMA 4, 4X, 6, 6P, 12, 13
 IEC IP67
 Construction—
 Stainless steel

Approvals

UL Listed
 CSA Certified



High Current Output



Page V8-T3-62

Overview

DC sensors which can carry extremely large continuous inrush current.

Applications

Heavy-duty vehicles, cement mixers, lift trucks, front end loaders, farm equipment.

Product Features

30 mm diameter stainless steel housing
Solid-state output for 12 ampere continuous, 50 ampere inrush capacity
-40° to 158°F (-40° to 70°C) temperature range
NO and NC isolated outputs
Heavy gauge SJO cable

Technical Data and Specifications

Current ratings—
Varies by model
Enclosure ratings—
NEMA 4, 4X, 6, 6P, 12, 13
IEC IP67
Construction—
Stainless steel

Approvals

Ferrous Only Tubular



Page V8-T3-55

Overview

Sensors designed to detect only ferrous metals (steel/iron).

Applications

Workcell applications, automotive and aircraft production

Product Features

18 mm diameters
Two-wire AC or three-wire DC
NO or NC outputs
Micro- and mini-pin terminations
LED indicators

Technical Data and Specifications

Current ratings—
AC: 500 mA continuous
DC: 200 mA continuous
Enclosure ratings—
NEMA 4, 4X, 6, 6P, 12, 13
IEC IP67
Construction—
Stainless steel

Approvals

UL Listed
CSA Certified



Small Diameter



Page V8-T3-65

Overview

Small diameter and short body (4, 5, 6.5 and 8 mm) tubular housings for tight sensing applications.

Applications

Automation equipment, robotics, machine tool, counting, sorting

Product Features

Variety of diameters in stainless steel housings
PVC cable, micro- and nano-pin connections
LED indicators standard
Short overall lengths
Short circuit and reverse polarity protection

Technical Data and Specifications

Current ratings—
DC: 200 mA maximum
Enclosure ratings—
NEMA 4, 4X, 6, 6P, 12, 13
IEC IP67
Construction—
Stainless steel

Approvals

CE



E56 Pancake



Page V8-T3-71

Overview

Self-contained sensors capable of sensing up to 3.94 inches (100 mm).

Applications

Oil rig operations, floor conveyors, automotive assembly, overhead cranes

Product Features

40, 50, 70 and 100 mm sensing distances
Four-wire DC models have complementary outputs (1 NO/1 NC)
Four-wire DC models use auto-configure technology, which allows the sensor to automatically adapt for NPN or PNP without user intervention
Available in two-wire AC versions
Power and output LED indicator
Quick disconnect option
Short-circuit protected in DC
Longest sensing distances available

Technical Data and Specifications

Current ratings—
AC: 500 mA continuous
DC: 200 mA continuous
Enclosure ratings—
NEMA 4, 4X, 12, 13
(some models also rated NEMA 6)
IEC IP66
Construction—
PPS

Approvals

cULus Listed



Tubular, Nonmetallic Housing



Page V8-T3-76

Overview

Tubular sensors with nonmetallic housings offer high corrosion resistance.

Applications

Food processing lines, high washdown environments

Product Features

- 12, 18 and 30 mm diameters shielded and unshielded sensing
- Normally open or closed outputs
- AC and DC voltages
- Tough ABS plastic housing
- Output LED on all models

Technical Data and Specifications

- Current ratings—
- AC: 150 mA
- DC: 200 mA
- Enclosure ratings—
- NEMA 3, 3S, 4, 4X, 13
- IEC IP66
- Construction—
- ABS plastic

Approvals

E52 Cube Style



Page V8-T3-79

Overview

A family of industry-standard, cube-sized inductive sensors with long range capabilities.

Applications

Automotive, manufacturing, machinery OEMs

Product Features

- Long inductive proximity ranges available (up to 40 mm sensing distance)
- Four-wire DC models have complementary outputs (1 NO/1 NC)
- Four-wire DC models use auto-configure technology, which allows the sensor to automatically adapt for NPN or PNP without user intervention
- Robust design featuring vibration and impact-absorbing potting compound
- Ideal for extreme temperatures or high pressure washdown environments

Technical Data and Specifications

- Current ratings—
- DC: 300 mA maximum
- Enclosure ratings—
- NEMA 4, 4X, 6, 6P, 12, 13
- IEC IP67
- Construction—
- Zinc alloy/PPS, PL

Approvals

cULus Listed



E52 Rectangular Style



Page V8-T3-83

Overview

A variety of small rectangular sensors for limited space applications.

Applications

Tight applications where conventional sensor are too large

Product Features

- Variety of housing styles R12, R18, Q16, Q25
- 10 to 30 Vdc
- NPN and PNP output
- Short-circuit protection
- LED indicator for output status

Technical Data and Specifications

- Current ratings—
- DC: 100 mA maximum
- Enclosure ratings—
- NEMA 1, 2, 3, 3S, 4, 12
- IEC IP66
- Construction—
- PBT composition housing

Approvals

3

E55 Limit Switch Style, Nonmetallic Housing



Page V8-T3-86

Overview

These nonmetallic sensors provide corrosion resistance in a limit switch style housing.

Applications

Food processing lines, high washdown environments

Product Features

5 position head can be top mounted or in any of four side positions
 Long sensing ranges up to 40 mm
 Normally open or closed outputs
 AC voltages
 Tough PBT resin housing

Technical Data and Specifications

Current ratings—
 AC: 400 mA
 Enclosure ratings—
 NEMA 4, 4X, 6, 12, 13
 IEC IP67
 Construction—
 PBT resin

Approvals

E51 Limit Switch Style, Factory Sealed 6P +



Page V8-T3-88

Overview

Completely epoxy filled in unitized, one piece limit switch style construction for reliable performance under the most adverse of environmental conditions.

Applications

All corrosive environments: Coolants/cutting oils, automotive applications

Product Features

One piece housing on switch body/receptacle
 Head and housing totally epoxy encapsulated
 Side sensing head can be unfastened and moved to any of four positions
 Quick disconnect options
 Corrosive resistant epoxy coated housing

Technical Data and Specifications

Current ratings—
 AC: 1 ampere continuous
 DC: 0.6 ampere continuous
 Enclosure ratings—
 NEMA 3, 3S, 4, 4X, 6, 6P, 12, 13
 IEC IP67
 Construction—
 Die cast zinc
 Gasket material: Viton®

Approvals

cUL Listed



E51 Limit Switch Style, Modular



Page V8-T3-97

Overview

Modular design allows maximum use of inventories in these limit switch style housings. Solid-state circuitry in a variety of sensing ranges.

Applications

Machine tool, punch presses, automotive, conveyor systems

Product Features

Modular heads, switch bodies, receptacles
 Shielded or unshielded sensing ranges
 Solid-state electronics
 Viton gasket seals
 LED indicators for power and output status
 Top and side sensing heads
 Alternate frequency for side by side operation
 Components individually labeled for easy identification

Technical Data and Specifications

Current ratings—
 AC: 1 ampere continuous
 DC: 0.6 ampere continuous
 Enclosure ratings—
 NEMA 3, 3S, 4, 4X, 6, 6P, 12, 13
 IEC IP67
 Class I, Class II, Division 2
 Groups A, B, C, D, F and G; Class III
 Construction—
 Die cast zinc
 Gasket material: Viton

Approvals

UL Listed
 CSA Certified (most models)



iProx Sensors



iProx Sensors

Product Description

The iProx represents the highest performance, most versatile tubular inductive sensor offered by Eaton's Electrical Sector. By utilizing an embedded micro-processor and exclusive SmartSense™ technology, iProx can sense up to three times farther than typical sensors of its class, while providing an unheard-of level of customization.

Both shielded and unshielded versions of iProx feature extended sensing ranges. This allows the sensor to be mounted farther from the target, thereby reducing the potential for target impacts and increasing the sensing reliability of your application.

The iProx also includes a wide range of advanced features that can be enabled via optional programming tools. Using the ProxView Windows-based software package, an entirely custom sensor can be programmed to perfectly fit an application.

For the most current information on this product, visit our Web site: www.eaton.com

Sensor characteristics, such as sensing range, can be customized down to the nearest tenth of a millimeter. Outputs can be changed from NO to NC. The iProx even features built-in timing delays and speed detection logic—no PLC programming is necessary.

With extended sensing range, quality construction and the ability to adapt to its environment, iProx is the ideal choice for even the most demanding inductive sensing applications.

Application Description

Typical Applications

- Automotive
- Machine tool
- Material handling
- Metalworking

Features

- Available in AC two-wire, DC three-wire and unique DC four-wire with complementary (NO-NC) or dual NO outputs
- Reliably detect metal targets at up to three times the range of conventional shielded or unshielded tubular inductive sensors

Contents

Description

	<i>Page</i>
iProx Sensors	
Product Selection	
iProx Sensors	V8-T3-12
Complementary and Dual Output Sensors	V8-T3-14
Compatible Connector Cables	V8-T3-15
Accessories	V8-T3-15
Technical Data and Specifications	V8-T3-16
Wiring Diagrams	V8-T3-17
Dimensions	V8-T3-17

- Quality construction using a stainless steel barrel, 360-degree dual-color LED indicator, Ryton® impact-resistant face cap and vibration-absorbing potting compound
- Auto-configure technology automatically detects a sinking (NPN) or sourcing (PNP) connection and switches the sensor accordingly, without any user intervention
- Exclusive SmartSense embedded microprocessor technology allows for customizable range, band sensing, nuisance metal rejection, timing delays and over/under speed detection
- Optional computer programming cable and Windows-based ProxView configuration software makes it easy to customize sensors
- Withstands high electrical noise (up to 20 V/m)
- Resistant to extreme temperatures (-40 °F [-40 °C])

Standards and Certifications

- cUL Listed
- CE



⚠ DANGER

THIS SENSOR IS NOT A SAFETY DEVICE AND IS NOT INTENDED TO BE USED AS A SAFETY DEVICE. This sensor is designed only to detect and read certain data in an electronic manner and perform no use apart from that, specifically no safety-related use. This sensor product does not include self-checking redundant circuitry, and the failure of this sensor product could cause either an energized or de-energized output condition, which could result in death, serious bodily injury, or property damage.

For Customer Service in the U.S. call 1-877-ETN CARE (386-2273), in Canada call 1-800-268-3578.
For Application Assistance in the U.S. and Canada call 1-800-426-9184.

3.1

Inductive Proximity Sensors

iProx Sensors







Product Selection

iProx Sensors

Note: Custom iProx models can also be ordered directly from the factory with pre-set ranges, outputs and connectors. Consult the Eaton Application Engineers at 1-800-426-9184 for more information.

3

Two-Wire Sensors

	Operating Voltage	Sensing Range	Shielding	Connection Type ^①	NO Output Catalog Number ^②	NC Output Catalog Number ^②
12 mm Diameter						
Standard Range 	20–132 Vac	4 mm	Shielded	3-pin micro AC connector	E59-M12A105A01-A1 ☺	E59-M12A105A01-A2 ☺
				3-pin micro AC pigtail ^③	E59-M12A105A01P-A1 ☺	E59-M12A105A01P-A2 ☺
				3-pin mini AC pigtail ^③	E59-M12A105A01PB-A1 ☺	E59-M12A105A01PB-A2 ☺
				2-meter cable	E59-M12A105C02-A1	E59-M12A105C02-A2
Extended Range 		10 mm	Unshielded	3-pin micro AC connector	E59-M12C110A01-A1 ☺	E59-M12C110A01-A2 ☺
				3-pin micro AC pigtail ^③	E59-M12C110A01P-A1 ☺	E59-M12C110A01P-A2 ☺
				3-pin mini AC pigtail ^③	E59-M12C110A01PB-A1 ☺	E59-M12C110A01PB-A2 ☺
				2-meter cable	E59-M12C110C02-A1	E59-M12C110C02-A2
18 mm Diameter						
Standard Range 	20–132 Vac	8 mm	Shielded	3-pin micro AC connector	E59-M18A109A01-A1 ☺	E59-M18A109A01-A2 ☺
				3-pin micro AC pigtail ^③	E59-M18A109A01P-A1 ☺	E59-M18A109A01P-A2 ☺
				3-pin mini AC pigtail ^③	E59-M18A109A01PB-A1 ☺	E59-M18A109A01PB-A2 ☺
				2-meter cable	E59-M18A109C02-A1	E59-M18A109C02-A2
Extended Range 		18 mm	Unshielded	3-pin micro AC connector	E59-M18C118A01-A1 ☺	E59-M18C118A01-A2 ☺
				3-pin micro AC pigtail ^③	E59-M18C118A01P-A1 ☺	E59-M18C118A01P-A2 ☺
				3-pin mini AC pigtail ^③	E59-M18C118A01PB-A1 ☺	E59-M18C118A01PB-A2 ☺
				2-meter cable	E59-M18C118C02-A1	E59-M18C118C02-A2
30 mm Diameter						
Standard Range 	20–132 Vac	15 mm	Shielded	3-pin micro AC connector	E59-M30A115A01-A1 ☺	E59-M30A115A01-A2 ☺
				3-pin micro AC pigtail ^③	E59-M30A115A01P-A1 ☺	E59-M30A115A01P-A2 ☺
				3-pin mini AC pigtail ^③	E59-M30A115A01PB-A1 ☺	E59-M30A115A01PB-A2 ☺
				2-meter cable	E59-M30A115C02-A1	E59-M30A115C02-A2
Extended Range 		29 mm	Unshielded	3-pin micro AC connector	E59-M30C129A01-A1 ☺	E59-M30C129A01-A2 ☺
				3-pin micro AC pigtail ^③	E59-M30C129A01P-A1 ☺	E59-M30C129A01P-A2 ☺
				3-pin mini AC pigtail ^③	E59-M30C129A01PB-A1 ☺	E59-M30C129A01PB-A2 ☺
				2-meter cable	E59-M30C129C02-A1	E59-M30C129C02-A2

Notes

☺ See listing of compatible connector cables on **Page V8-T3-15**.







① For sensors with custom cable lengths or PUR jackets, contact Application Engineering at 1-800-426-9184.

② Sensors are ordered with pre-set outputs from the factory, but can be later programmed either NO or NC using the ProxView software.

③ Standard pigtail cable length is 12 in.

Note: Custom iProx models can also be ordered directly from the factory with pre-set ranges, outputs and connectors. Consult the Eaton Application Engineers at 1-800-426-9184 for more information.

Three-Wire Sensors

	Operating Voltage	Sensing Range	Shielding	Connection Type ^①	NO Output Catalog Number ^②	NC Output Catalog Number ^②
Standard Range	12 mm Diameter					
	6–48 Vdc	4 mm	Shielded	4-pin micro DC connector	E59-M12A105D01-D1 ⊕	E59-M12A105D01-D2 ⊕
				4-pin micro DC pigtail ^③	E59-M12A105D01P-D1 ⊕	E59-M12A105D01P-D2 ⊕
				2-meter cable	E59-M12A105C02-D1	E59-M12A105C02-D2
Extended Range		10 mm	Unshielded	4-pin micro DC connector	E59-M12C110D01-D1 ⊕	E59-M12C110D01-D2 ⊕
				4-pin micro DC pigtail ^③	E59-M12C110D01P-D1 ⊕	E59-M12C110D01P-D2 ⊕
				2-meter cable	E59-M12C110C02-D1	E59-M12C110C02-D2
	Standard Range	18 mm Diameter				
	6–48 Vdc	8 mm	Shielded	4-pin micro DC connector	E59-M18A108D01-D1 ⊕	E59-M18A108D01-D2 ⊕
				4-pin micro DC pigtail ^③	E59-M18A108D01P-D1 ⊕	E59-M18A108D01P-D2 ⊕
				2-meter cable	E59-M18A108C02-D1	E59-M18A108C02-D2
Extended Range		18 mm	Unshielded	4-pin micro DC connector	E59-M18C116D01-D1 ⊕	E59-M18C116D01-D2 ⊕
				4-pin micro DC pigtail ^③	E59-M18C116D01P-D1 ⊕	E59-M18C116D01P-D2 ⊕
				2-meter cable	E59-M18C116C02-D1	E59-M18C116C02-D2
	Standard Range	30 mm Diameter				
	6–48 Vdc	15 mm	Shielded	4-pin micro DC connector	E59-M30A115D01-D1 ⊕	E59-M30A115D01-D2 ⊕
				4-pin micro DC pigtail ^③	E59-M30A115D01P-D1 ⊕	E59-M30A115D01P-D2 ⊕
				2-meter cable	E59-M30A115C02-D1	E59-M30A115C02-D2
Extended Range		29 mm	Unshielded	4-pin micro DC connector	E59-M30C129D01-D1 ⊕	E59-M30C129D01-D2 ⊕
				4-pin micro DC pigtail ^③	E59-M30C129D01P-D1 ⊕	E59-M30C129D01P-D2 ⊕
				2-meter cable	E59-M30C129C02-D1	E59-M30C129C02-D2

Notes

- ⊕ See listing of compatible connector cables on **Page V8-T3-15**.
- ① For sensors with custom cable lengths or PUR jackets, contact Application Engineering at 1-800-426-9184.
- ② Sensors are ordered with pre-set outputs from the factory, but can be later programmed either NO or NC using the ProxView software.
- ③ Standard pigtail cable length is 12 in.

3.1







Inductive Proximity Sensors

iProx Sensors

Complementary and Dual Output Sensors

Four-Wire Sensors

3

	Operating Voltage	Sensing Range	Shielding	Output Type	Connection Type	Complementary Output (1NO-1NC) Catalog Number	Dual NO Output Catalog Number ^①
Standard Range	12 mm Diameter						
	6–48 Vdc	4 mm	Shielded	NPN (sinking)	4-pin micro DC connector	E59-M12A105D01-D3NN ☺	E59-M12A105D01-D1NN ☺
					2-meter cable	E59-M12A105C02-D3NN	E59-M12A105C02-D1NN
Extended Range				PNP (sourcing)	4-pin micro DC connector	E59-M12A105D01-D3PP ☺	E59-M12A105D01-D1PP ☺
					2-meter cable	E59-M12A105C02-D3PP	E59-M12A105C02-D1PP
		10 mm	Unshielded	NPN (sinking)	4-pin micro DC connector	E59-M12C110D01-D3NN ☺	E59-M12C110D01-D1NN ☺
					2-meter cable	E59-M12C110C02-D3NN	E59-M12C110C02-D1NN
Extended Range				PNP (sourcing)	4-pin micro DC connector	E59-M12C110D01-D3PP ☺	E59-M12C110D01-D1PP ☺
					2-meter cable	E59-M12C110C02-D3PP	E59-M12C110C02-D1PP
Standard Range	18 mm Diameter						
	6–48 Vdc	8 mm	Shielded	NPN (sinking)	4-pin micro DC connector	E59-M18A108D01-D3NN ☺	E59-M18A108D01-D1NN ☺
					2-meter cable	E59-M18A108C02-D3NN	E59-M18A108C02-D1NN
Extended Range				PNP (sourcing)	4-pin micro DC connector	E59-M18A108D01-D3PP ☺	E59-M18A108D01-D1PP ☺
					2-meter cable	E59-M18A108C02-D3PP	E59-M18A108C02-D1PP
		18 mm	Unshielded	NPN (sinking)	4-pin micro DC connector	E59-M18C116D01-D3NN ☺	E59-M18C116D01-D1NN ☺
					2-meter cable	E59-M18C116C02-D3NN	E59-M18C116C02-D1NN
Extended Range				PNP (sourcing)	4-pin micro DC connector	E59-M18C116D01-D3PP ☺	E59-M18C116D01-D1PP ☺
					2-meter cable	E59-M18C116C02-D3PP	E59-M18C116C02-D1PP
Standard Range	30 mm Diameter						
	6–48 Vdc	15 mm	Shielded	NPN (sinking)	4-pin micro DC connector	E59-M30A115D01-D3NN ☺	E59-M30A115D01-D1NN ☺
					2-meter cable	E59-M30A115C02-D3NN	E59-M30A115C02-D1NN
Extended Range				PNP (sourcing)	4-pin micro DC connector	E59-M30A115D01-D3PP ☺	E59-M30A115D01-D1PP ☺
					2-meter cable	E59-M30A115C02-D3PP	E59-M30A115C02-D1PP
		29 mm	Unshielded	NPN (sinking)	4-pin micro DC connector	E59-M30C129D01-D3NN ☺	E59-M30C129D01-D1NN ☺
					2-meter cable	E59-M30C129C02-D3NN	E59-M30C129C02-D1NN
Extended Range				PNP (sourcing)	4-pin micro DC connector	E59-M30C129D01-D3PP ☺	E59-M30C129D01-D1PP ☺
					2-meter cable	E59-M30C129C02-D3PP	E59-M30C129C02-D1PP





Notes

☺ See listing of compatible connector cables on [Page V8-T3-15](#).

① At this time, iProx Complementary and Dual Output models are not available with auto-sink/source detection. Therefore, PNP (sourcing) and NPN (sinking) models must be ordered separately.



Compatible Connector Cables

Standard Cables ^①

	Current Rating at 600 V	Voltage Style	Number of Pins	Gauge	Length	Pin Configuration/Wire Colors (Face View Female Shown)	PVC Jacket Catalog Number	PUR Jacket Catalog Number
Micro-Style Straight Female 	Micro-Style, Straight Female							
	—	AC	3-pin, 3-wire	22 AWG	6.0 ft (2m)	 1-Green 2-Red/Black 3-Red/White	CSAS3F3CY2202	CSAS3F3RY2202
Mini-Style Straight Female 	Mini-Style, Straight Female							
	13 A	—	3-pin	16 AWG	6 ft (2m)	 1-Brown 2-White 3-Blue 4-Black	CSDS4A4CY2202	CSDS4A4RY2202
							Catalog Number	
							CSMS3F3CY1602	

Accessories

iProx Sensors

	Description	Catalog Number
Software 	Step-by-step programming software required to program iProx. Compatible with Microsoft Windows® and Windows® Mobile devices.	E59SW1
Cable 	The iProx programming cable is used to program individual iProx sensors, providing a connection between the computer and the sensor. Connects to computer via a serial (RS-232) or USB port. (USB connection requires an adapter which is included with purchase.)	E59RP1
Labels 	Field applied labels for iProx sensor (100 pcs)	E59LABEL

Note

^① For a full selection of connector cables, see **Tab 10, section 10.1**.

3.1

Inductive Proximity Sensors

iProx Sensors

Starter Kit



iProx Starter Kits

Description **Catalog Number**

Interested in custom programming iProx sensors to fit your application?

These kits include everything needed to get the most out of iProx: a sensor, a programming cable (E59RP1), a micro connector cable (CSDS4A4CY2202) and ProxView software on CD-ROM (E59SW1).

Starter kit includes:

12 mm AC unshielded iProx sensor (E59-M12C110A01-A1)	E5912ACKIT
12 mm DC unshielded iProx sensor (E59-M12C110D01-D1)	E5912DCKIT
18 mm AC unshielded iProx sensor (E59-M18C118A01-A1)	E5918ACKIT
18 mm DC unshielded iProx sensor (E59-M18C116D01-D1)	E5918DCKIT
30 mm AC unshielded iProx sensor (E59-M30C129A01-A1)	E5930ACKIT
30 mm DC unshielded iProx sensor (E59-M30C129D01-D1)	E5930DCKIT

Technical Data and Specifications

iProx Sensors

Description	Two-Wire Sensors	Three-Wire Sensors
Input voltage	20–132 Vac	6–48 Vdc
Load current	250 mA	300 mA
Leakage current	≤1.7 mA at 32 °F (0 °C), 2.0 mA at –40 °F (–40 °C)	≤150 μA
Voltage drop	<5 Vac	≤2.5 Vdc
Burden current	—	≤15 mA
Protection	None	Auto reset
Switching hysteresis	<15% rated sensing distance	<15% rated sensing distance
Repeat accuracy	Shielded models: <1% sensing distance; Unshielded models: <3% sensing distance	Shielded models: <1% sensing distance; Unshielded models: <3% sensing distance
Surge capacity	3 A/30 ms	—
Temperature range	–40 to 158 °F (–40 to 70 °C)	–40 to 158 °F (–40 to 70 °C)
Material of construction	303 stainless steel; end bells: polycarbonate; face caps: Ryton®; cable: AWM style 20387 (PVC)	303 stainless steel; end bells: polycarbonate; face caps: Ryton®; cable: AWM style 20387 (PVC)
Vibration and shock	Vibration: 10 to 55 Hz, 1 mm amplitude, IEC 60068-2-6; shock: 30 g, 11 ms per IEC 68-2-27	Vibration: 10 to 55 Hz, 1 mm amplitude, IEC 60068-2-6; shock: 30 g, 11 ms per IEC 68-2-27
Indicator LED	360° viewable LED	360° viewable LED
Enclosure ratings	NEMA 4, 4X, 6, 6P, 12 and 13 (IP67) IP69K ①	NEMA 4, 4X, 6, 6P, 12 and 13 (IP67) IP69K ①

Response Time ②

Description	Two-Wire Sensors All Two-Wire Models	Three-Wire Sensors Shielded			Unshielded		
		12 mm	18 mm	30 mm	12 mm	18 mm	30 mm
Factory default mode	Shipped in “Side by Side Mode” by default (20 V/m)	580 Hz (10 V/m)	390 Hz (10 V/m)	240 Hz (10 V/m)	300 Hz (10 V/m)	150 Hz (10 V/m)	145 Hz (10 V/m)
Side by side ③	30 Hz (10 V/m)	50 Hz (20 V/m)	50 Hz (20 V/m)	50 Hz (20 V/m)	50 Hz (20 V/m)	50 Hz (20 V/m)	50 Hz (20 V/m)
High noise immunity mode	10 Hz (>20 V/m)	10 Hz (>20 V/m)	10 Hz (>20 V/m)	10 Hz (>20 V/m)	10 Hz (>20 V/m)	10 Hz (>20 V/m)	10 Hz (>20 V/m)

Notes

Ryton® is a registered trademark of Phillips Chemical (division of Phillips Petroleum).

① Our products conform to NEMA® tests as indicated, however, some severe washdown applications can exceed these NEMA test specifications.

② iProx sensors may be programmed to perform in side by side or high noise immunity applications using the iProx programming cable (E59RP1) and ProxView software (E59SW1).

③ Use the side by side response time parameter when using the iProx Tray Programmer (E59TP1), iProx programming cable (E59RP1) and ProxView software (E59SW1).

Wiring Diagrams

Pin numbers are for reference, rely on pin location when wiring.

iProx Sensors

Operating Voltage	Output	Cable Models	Connector Models (Face View Male Shown)	Micro	Mini
Two-Wire Sensors					
20–132 Vac	NO and NC				
Three-Wire Sensors					
6–48 Vdc	NO and NC (NPN and PNP) ①	②	②		
Four-Wire Dual Output and Complementary Sensors					
6–48 Vdc	NO and NC (NPN)	③	③		
	NO and NC (PNP)	③	③		

Dimensions

Approximate Dimensions in Inches (mm)

Cable Models

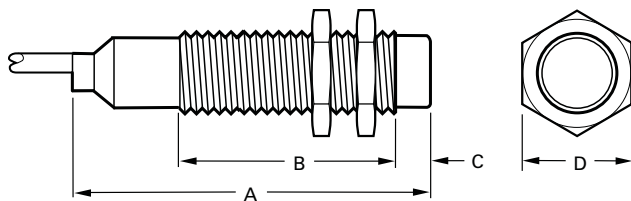

Size	Shielding	A	B	C	D
12 mm	Shielded	2.46 (62.4)	1.98 (50.3)	0.02 (0.5)	0.67 (17)
	Unshielded	2.46 (62.4)	1.64 (41.6)	0.36 (9)	0.67 (17)
18 mm	Shielded	2.54 (64.5)	2.00 (50.9)	0.02 (0.5)	0.94 (24)
	Unshielded	2.54 (64.5)	1.47 (37.4)	0.55 (14)	0.94 (24)
30 mm	Shielded	2.74 (69.6)	2.13 (54.1)	0.03 (0.75)	1.41 (36)
	Unshielded	2.74 (69.6)	1.41 (35.8)	0.75 (19)	1.41 (36)

Micro-Connector Models

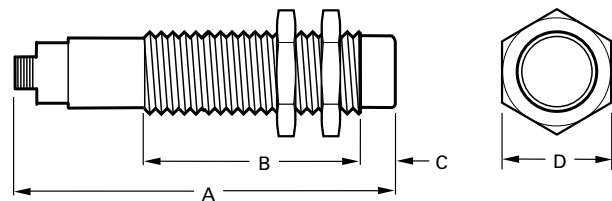

Size	Shielding	A	B	C	D
12 mm	Shielded	2.71 (68.7)	1.98 (50.3)	0.02 (0.5)	0.67 (17)
	Unshielded	2.71 (68.7)	1.64 (41.6)	0.36 (9)	0.67 (17)
18 mm	Shielded	2.73 (69.3)	2.00 (50.9)	0.02 (0.5)	0.94 (24)
	Unshielded	2.73 (69.3)	1.47 (37.4)	0.55 (14)	0.94 (24)
30 mm	Shielded	2.92 (74.1)	2.13 (54.1)	0.03 (0.75)	1.41 (36)
	Unshielded	2.92 (74.1)	1.41 (35.8)	0.75 (19)	1.41 (36)

Notes

- ① The three-wire DC version of iProx automatically configures itself to NPN or PNP based on field wiring. No user intervention is required.
- ② Pin numbers 2 and 4 are internally jumpered together. Either pin may be used.
- ③ The complementary (1NO-1NC) output models feature the NC output on pin 2 (white).

3.2

Inductive Proximity Sensors

E57P Performance Series Sensors

3

E57P Performance Series Sensors



Contents

<i>Description</i>	<i>Page</i>
E57P Performance Series Sensors	
Product Selection	
E57P Performance Sensors	V8-T3-19
Compatible Connector Cables	V8-T3-20
Accessories	V8-T3-20
Technical Data and Specifications	V8-T3-21
Wiring Diagrams	V8-T3-22
Dimensions	V8-T3-23

E57P Performance Series Sensors

Product Description

For sensing applications requiring more demanding specifications, the new E57P Performance series incorporates premium features without the premium price. With its stainless steel tubular body, IP69K rating, wide temperature range (down to -40 °C), fast switching speed and laser-etched markings, the E57P series provides value at a low price point.

Features

- 360° LED indicator
- Stainless steel tube
- 10–48 Vdc operating voltage
- Short-circuit protection
- -40 to 70 °C temperature range
- IP69K environmental rating
- Durable laser-engraved label
- Available in cable and micro-connector styles

Standards and Certifications

- cULus Listed
- CE



DANGER

THIS SENSOR IS NOT A SAFETY DEVICE AND IS NOT INTENDED TO BE USED AS A SAFETY DEVICE. This sensor is designed only to detect and read certain data in an electronic manner and perform no use apart from that, specifically no safety-related use. This sensor product does not include self-checking redundant circuitry, and the failure of this sensor product could cause either an energized or de-energized output condition, which could result in death, serious bodily injury, or property damage.



For the most current information on this product, visit our Web site: www.eaton.com

For Customer Service in the U.S. call 1-877-ETN CARE (386-2273), in Canada call 1-800-268-3578. For Application Assistance in the U.S. and Canada call 1-800-426-9184.

Product Selection

E57P Performance Sensors

Three-Wire Sensors

	Operating Voltage	Sensing Range (Sn)	Shielding	Connection Type ^①	NO Output Catalog Number	NC Output Catalog Number
 <p>12 mm</p>	12 mm Diameter End Sensing					
	10–48 Vdc	2 mm (standard range)	Shielded (PNP)	2-meter cable	E57P-12SPN2-C2	E57P-12SPC2-C2
				4-pin micro DC connector	E57P-12SPN2-Q	E57P-12SPC2-Q
			Shielded (NPN)	2-meter cable	E57P-12SNN2-C2	E57P-12SNC2-C2
				4-pin micro DC connector	E57P-12SNN2-Q	E57P-12SNC2-Q
		4 mm (standard range)	Unshielded (PNP)	2-meter cable	E57P-12UPN4-C2	E57P-12UPC4-C2
				4-pin micro DC connector	E57P-12UPN4-Q	E57P-12UPC4-Q
			Unshielded (NPN)	2-meter cable	E57P-12UNN4-C2	E57P-12UNC4-C2
				4-pin micro DC connector	E57P-12UNN4-Q	E57P-12UNC4-Q
		4 mm (extended range)	Shielded (PNP)	2-meter cable	E57P-12SPN4-C2	E57P-12SPC4-C2
				4-pin micro DC connector	E57P-12SPN4-Q	E57P-12SPC4-Q
			Shielded (NPN)	2-meter cable	E57P-12SNN4-C2	E57P-12SNC4-C2
				4-pin micro DC connector	E57P-12SNN4-Q	E57P-12SNC4-Q
	8 mm (extended range)	Unshielded (PNP)	2-meter cable	E57P-12UPN8-C2	E57P-12UPC8-C2	
			4-pin micro DC connector	E57P-12UPN8-Q	E57P-12UPC8-Q	
		Unshielded (NPN)	2-meter cable	E57P-12UNN8-C2	E57P-12UNC8-C2	
			4-pin micro DC connector	E57P-12UNN8-Q	E57P-12UNC8-Q	
	 <p>18 mm</p>	18 mm Diameter End Sensing				
10–48 Vdc		5 mm (standard range)	Shielded (PNP)	2-meter cable	E57P-18SPN5-C2	E57P-18SPC5-C2
				4-pin micro DC connector	E57P-18SPN5-Q	E57P-18SPC5-Q
			Shielded (NPN)	2-meter cable	E57P-18SNN5-C2	E57P-18SNC5-C2
				4-pin micro DC connector	E57P-18SNN5-Q	E57P-18SNC5-Q
		8 mm (standard range)	Unshielded (PNP)	2-meter cable	E57P-18UPN8-C2	E57P-18UPC8-C2
				4-pin micro DC connector	E57P-18UPN8-Q	E57P-18UPC8-Q
			Unshielded (NPN)	2-meter cable	E57P-18UNN8-C2	E57P-18UNC8-C2
				4-pin micro DC connector	E57P-18UNN8-Q	E57P-18UNC8-Q
		8 mm (extended range)	Shielded (PNP)	2-meter cable	E57P-18SPN8-C2	E57P-18SPC8-C2
				4-pin micro DC connector	E57P-18SPN8-Q	E57P-18SPC8-Q
			Shielded (NPN)	2-meter cable	E57P-18SNN8-C2	E57P-18SNC8-C2
				4-pin micro DC connector	E57P-18SNN8-Q	E57P-18SNC8-Q
12 mm (extended range)		Unshielded (PNP)	2-meter cable	E57P-18UPN12-C2	E57P-18UPC12-C2	
			4-pin micro DC connector	E57P-18UPN12-Q	E57P-18UPC12-Q	
		Unshielded (NPN)	2-meter cable	E57P-18UNN12-C2	E57P-18UNC12-C2	
			4-pin micro DC connector	E57P-18UNN12-Q	E57P-18UNC12-Q	

Notes

⊕ See listing of compatible connector cables on [Page V8-T3-20](#).

① For cable lengths longer than 2 meters, add the number of the desired length in meters to the end of the listed catalog number (for catalog numbers ending with a number, add an **S** and then the length). Examples for a 5-meter cable: E57-18LE12-A becomes E57-18LE12-A5; E57LAL12A2 becomes E57LAL12A2S5.

3.2

Inductive Proximity Sensors

E57P Performance Series Sensors

Three-Wire Sensors, continued

30 mm



3

Operating Voltage	Sensing Range (Sn)	Shielding	Connection Type ①	NO Output Catalog Number	NC Output Catalog Number	
30 mm Diameter End Sensing						
10–48 Vdc	10 mm (standard range)	Shielded (PNP)	2-meter cable	E57P-30SPN10-C2	E57P-30SPC10-C2	
			4-pin micro DC connector	E57P-30SPN10-Q	E57P-30SPC10-Q	
		Shielded (NPN)	2-meter cable	E57P-30SNN10-C2	E57P-30SNC10-C2	
			4-pin micro DC connector	E57P-30SNN10-Q	E57P-30SNC10-Q	
		15 mm (standard range)	Unshielded (PNP)	2-meter cable	E57P-30UPN15-C2	E57P-30UPC15-C2
				4-pin micro DC connector	E57P-30UPN15-Q	E57P-30UPC15-Q
	Unshielded (NPN)		2-meter cable	E57P-30UNN15-C2	E57P-30UNC15-C2	
			4-pin micro DC connector	E57P-30UNN15-Q	E57P-30UNC15-Q	
	15 mm (extended range)	Shielded (PNP)	2-meter cable	E57P-30SPN15-C2	E57P-30SPC15-C2	
			4-pin micro DC connector	E57P-30SPN15-Q	E57P-30SPC15-Q	
		Shielded (NPN)	2-meter cable	E57P-30SNN15-C2	E57P-30SNC15-C2	
			4-pin micro DC connector	E57P-30SNN15-Q	E57P-30SNC15-Q	
22 mm (extended range)		Unshielded (PNP)	2-meter cable	E57P-30UPN22-C2	E57P-30UPC22-C2	
			4-pin micro DC connector	E57P-30UPN22-Q	E57P-30UPC22-Q	
Unshielded (NPN)	2-meter cable	E57P-30UNN22-C2	E57P-30UNC22-C2			
	4-pin micro DC connector	E57P-30UNN22-Q	E57P-30UNC22-Q			

Compatible Connector Cables

Standard Cables ①

Current Rating at 600 V	Voltage Style	Number of Pins	Gauge	Length	Pin Configuration/Wire Colors (Face View Female Shown)	PVC Jacket Catalog Number	PUR Jacket Catalog Number
Micro-Style, Straight Female							
—	DC	4-pin, 4-wire	22 AWG	6.0 ft (2m)		CSDS4A4CY2202	CSDS4A4RY2202

Accessories

E57P Performance Sensors

Description	Reference
Mounting brackets	See Tab 8, section 8.2
Replacement mounting nuts and other accessories	See Tab 8, section 8.3
Connector cables	See Tab 10, section 10.1

Notes

② See listing of compatible connector cables on **Page V8-T3-20**.

① For cable lengths longer than 2 meters, add the number of the desired length in meters to the end of the listed catalog number (for catalog numbers ending with a number, add an **S** and then the length). Examples for a 5-meter cable: E57-18LE12-A becomes E57-18LE12-A**5**; E57LAL12A2 becomes E57LAL12A2**S5**.

② For a full selection of connector cables, see **Tab 10, section 10.1**.

Technical Data and Specifications

E57P Performance Sensors

Description	Performance Three-Wire DC Sensors
Operating voltage	10–48 Vdc
Output current (continuous)	300 mA
Switching frequency [Hz]	Standard range: 12 mm—Shielded: 2000; Unshielded: 2000 18 mm—Shielded: 1200; Unshielded: 1200 30 mm—Shielded: 600; Unshielded: 500 Extended range: 12 mm—Shielded: 1200; Unshielded: 500 18 mm—Shielded: 300; Unshielded: 300 30 mm—Shielded: 400; Unshielded: 200
Leakage current	<100 μ A
Output voltage drop [Vsat]	<2.5 V
Current consumption	<10 mA
Short-circuit protection	Yes (Auto Reset)
Hysteresis [% of Sr]	2–20%
Repeat accuracy	1% shielded, 3% unshielded
Time delay before availability	<200 ms
Output indicator LED	360° amber LED
Operating temperature range	–40 to 70 °C
Ingress protection	IEC IP67, IP69K, UL Type 1, NEMA Type 6P, NEMA Type 4X
Shock	30 g, 11 ms per IEC 68-2-76
Vibration	10 to 55 Hz, 1 mm amplitude
Housing materials	Front face: Ryton Tube: Stainless steel End bells: M12 body: Polycarbonate Cable end bell: Polycarbonate Nuts: Stainless steel
Cable	AWM style 20387 (PVC)

Recommended Mounting Clearances

For unshielded standard range sensors and extended range sensors, clearance must be provided around the sensor when mounting for reliable performance. (“Sn” is the sensing range of the sensor, “d” is the sensor diameter.)

E57P Performance Sensors, Mounting

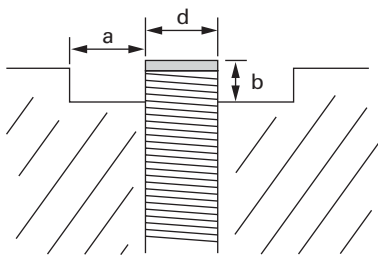

Type	Shielding	a	b
Standard range	Shielded	0	0
	Unshielded	Cap height	2 x 5n
Extended range	Shielded	0	0
	Unshielded	Cap height	2 x Sn

Note

Ryton® is a registered trademark of Phillips Chemical (division of Phillips Petroleum).

① 40–240 Vac at <–4 °F (<–20 °C).

3.2

Inductive Proximity Sensors

E57P Performance Series Sensors

Wiring Diagrams

Pin numbers are for reference, rely on pin location when wiring.

E57P Performance Sensors

3

Operating Voltage	Output	Cable Models	Connector Models (Face View Male Shown) Micro
Three-Wire Sensors			
10–48 Vdc	NO (NPN)		
	NO (PNP)		
	NC (NPN)		
	NC (PNP)		

Dimensions

Approximate Dimensions in Inches (mm)

E57P Performance Series Sensors, End Sensing^①

Cable Models

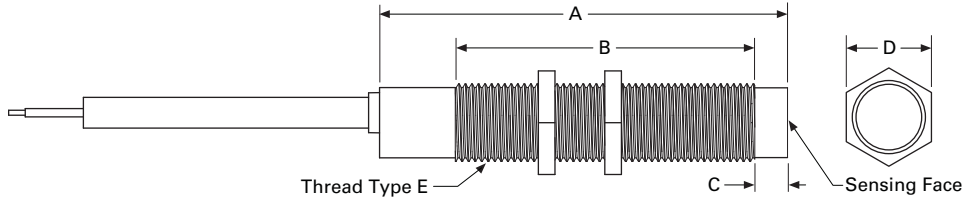

Connector Models

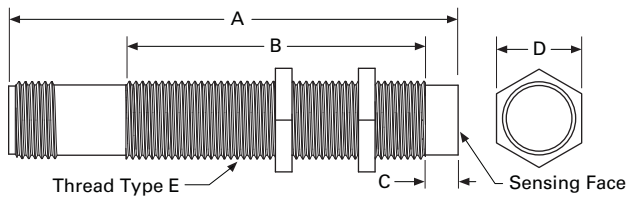

Size	Shielding	Overall Length A	Threaded Length B	Cap Height C	Nut Width D	Thread Size E
Three-Wire DC Sensors—Cable Models						
12 mm	Shielded	2.52 (64.1)	1.98 (50.3)	—	0.67 (16.8)	M12 x 1
	Unshielded	2.52 (64.1)	1.80 (45.8)	0.20 (5.0)	0.67 (16.8)	M12 x 1
18 mm	Shielded	2.59 (65.9)	2.00 (50.9)	—	0.94 (23.8)	M18 x 1
	Unshielded	2.59 (65.9)	1.75 (44.4)	0.28 (7.0)	0.94 (23.8)	M18 x 1
30 mm	Shielded	2.67 (67.7)	1.98 (50.3)	—	1.41 (35.9)	M30 x 1.5
	Unshielded	2.67 (67.7)	1.49 (37.8)	0.51 (13.0)	1.41 (35.9)	M30 x 1.5
Three-Wire DC Sensors—Micro-Connector Models						
12 mm	Shielded	2.70 (68.7)	1.98 (50.3)	—	0.67 (16.8)	M12 x 1
	Unshielded	2.70 (68.7)	1.80 (45.8)	0.20 (5.0)	0.67 (16.8)	M12 x 1
18 mm	Shielded	2.72 (69.2)	2.00 (50.9)	—	0.94 (23.8)	M18 x 1
	Unshielded	2.72 (69.2)	1.75 (44.4)	0.28 (7.0)	0.94 (23.8)	M18 x 1
30 mm	Shielded	2.79 (70.9)	1.98 (50.3)	—	1.41 (35.9)	M30 x 1.5
	Unshielded	2.79 (70.9)	1.49 (37.8)	0.51 (13.0)	1.41 (35.9)	M30 x 1.5

Note

^① These dimensions apply to the Performance Series models in this section.

3.3

Inductive Proximity Sensors

E57PS Performance Short Body Sensors

E57PS Performance Short Body Sensors

3



Contents

<i>Description</i>	<i>Page</i>
E57PS Performance Short Body Sensors	
Product Selection	
E57PS Performance Short Body Sensors . . .	V8-T3-25
Compatible Connector Cables	V8-T3-25
Accessories	V8-T3-26
Technical Data and Specifications	V8-T3-26
Wiring Diagrams	V8-T3-27
Dimensions	V8-T3-27

E57PS Performance Short Body Sensors

Product Description

For demanding sensing applications in areas too small for standard length units, the E57PS Performance Short Body series is an ideal solution as it incorporates the premium features of the E57P series but in a shorter body length. With its stainless steel tubular body, IP69K rating, wide temperature range (down to -40 °C), fast switching speed and laser-etched markings, the E57PS series provides value at a low price point.

Features

- 360° LED indicator
- Stainless steel tube
- 10–48 Vdc operating voltage
- Short-circuit protection
- -40 to 70 °C temperature range
- IP69K environmental rating
- Durable laser-engraved label
- Available in cable and micro-connector styles

Standards and Certifications

- cULus Listed
- CE



⚠ DANGER

THIS SENSOR IS NOT A SAFETY DEVICE AND IS NOT INTENDED TO BE USED AS A SAFETY DEVICE. This sensor is designed only to detect and read certain data in an electronic manner and perform no use apart from that, specifically no safety-related use. This sensor product does not include self-checking redundant circuitry, and the failure of this sensor product could cause either an energized or de-energized output condition, which could result in death, serious bodily injury, or property damage.



For the most current information on this product, visit our Web site: www.eaton.com

For Customer Service in the U.S. call 1-877-ETN CARE (386-2273), in Canada call 1-800-268-3578. For Application Assistance in the U.S. and Canada call 1-800-426-9184.

Product Selection



E57PS Performance Short Body Sensors

Three-Wire Sensors

	Operating Voltage	Sensing Range (Sn)	Shielding	Connection Type ^①	NO Output Catalog Number	NC Output Catalog Number		
	10–48 Vdc	2 mm (standard range)	Shielded (PNP)	2-meter cable	E57PS-12SNN2-C2	E57PS-12SNC2-C2		
				4-pin micro DC connector	E57PS-12SNN2-Q ⊕	E57PS-12SNC2-Q ⊕		
			Shielded (NPN)	2-meter cable	E57PS-12SPN2-C2	E57PS-12SPC2-C2		
				4-pin micro DC connector	E57PS-12SPN2-Q ⊕	E57PS-12SPC2-Q ⊕		
		4 mm (standard range)	Unshielded (PNP)	2-meter cable	E57PS-12UNN4-C2	E57PS-12UNC4-C2		
				4-pin micro DC connector	E57PS-12UNN4-Q ⊕	E57PS-12UNC4-Q ⊕		
			Unshielded (NPN)	2-meter cable	E57PS-12UPN4-C2	E57PS-12UPC4-C2		
				4-pin micro DC connector	E57PS-12UPN4-Q ⊕	E57PS-12UPC4-Q ⊕		
	10–48 Vdc	5 mm (standard range)	Shielded (PNP)	2-meter cable	E57PS-18SNN2-C2	E57PS-18SNC2-C2		
				4-pin micro DC connector	E57PS-18SNN2-Q ⊕	E57PS-18SNC2-Q ⊕		
			Shielded (NPN)	2-meter cable	E57PS-18SPN2-C2	E57PS-18SPC2-C2		
				4-pin micro DC connector	E57PS-18SPN2-Q ⊕	E57PS-18SPC2-Q ⊕		
		8 mm (standard range)	Unshielded (PNP)	2-meter cable	E57PS-18UNN4-C2	E57PS-18UNC4-C2		
				4-pin micro DC connector	E57PS-18UNN4-Q ⊕	E57PS-18UNC4-Q ⊕		
			Unshielded (NPN)	2-meter cable	E57PS-18UPN4-C2	E57PS-18UPC4-C2		
				4-pin micro DC connector	E57PS-18UPN4-Q ⊕	E57PS-18UPC4-Q ⊕		
			10–48 Vdc	10 mm (standard range)	Shielded (PNP)	2-meter cable	E57PS-30SNN2-C2	E57PS-30SNC2-C2
						4-pin micro DC connector	E57PS-30SNN2-Q ⊕	E57PS-30SNC2-Q ⊕
					Shielded (NPN)	2-meter cable	E57PS-30SPN2-C2	E57PS-30SPC2-C2
						4-pin micro DC connector	E57PS-30SPN2-Q ⊕	E57PS-30SPC2-Q ⊕
15 mm (standard range)	Unshielded (PNP)			2-meter cable	E57PS-30UNN4-C2	E57PS-30UNC4-C2		
				4-pin micro DC connector	E57PS-30UNN4-Q ⊕	E57PS-30UNC4-Q ⊕		
	Unshielded (NPN)			2-meter cable	E57PS-30UPN4-C2	E57PS-30UPC4-C2		
				4-pin micro DC connector	E57PS-30UPN4-Q ⊕	E57PS-30UPC4-Q ⊕		

Compatible Connector Cables

Standard Cables ^②

	Voltage Style	Number of Pins	Gauge	Length	Pin Configuration/Wire Colors (Face View Female Shown)	PVC Jacket Catalog Number	PUR Jacket Catalog Number
	Micro-Style, Straight Female						
	DC	4-pin, 4-wire	22 AWG	6.0 ft (2m)	 1-Brown 2-White 3-Blue 4-Black	CSDS4A4CY2202	CSDS4A4RY2202

Notes

- ⊕ See listing of compatible connector cables above.
- ① Cable models are supplied as standard with a 2-meter cable. A 5-meter cable is available by adding **S5** to the catalog number. Example: E57SAL12T110 becomes E57SAL12T110**S5**.
- ② For a full selection of connector cables, see **Tab 10, section 10.1**.

Accessories

E57PS Performance Short Body Sensors

Description	Reference
Mounting brackets	See Tab 8, section 8.2
Replacement mounting nuts and other accessories	See Tab 8, section 8.3
Connector cables	See Tab 10, section 10.1

Technical Data and Specifications

E57PS Performance Short Body Sensors

Description	Three-Wire DC Sensors
Operating voltage	10–48 Vdc
Maximum load current	300 mA
Switching frequency [Hz]	12 mm—Shielded: 2000; Unshielded: 2000 18 mm—Shielded: 1200; Unshielded: 1200 30 mm—Shielded: 600; Unshielded: 500
Leakage current	100 μ A maximum
Voltage drop	≤ 2.5 V
Holding current	≤ 10 mA
Short-circuit protection	Yes (Auto Reset)
Switching hysteresis	2–20% of rated sensing distance
Repeat accuracy	1% shielded, 3% unshielded
Output indicator LED	360° amber LED
Operating temperature	–40 to 158 °F (–40 to 70 °C)
Enclosure ratings	IP67, IP69K; NEMA 4, 4X, 6, 6P
Shock	30 g sine wave, 11 ms per IEC68-2-76
Vibration	10 to 55 Hz, 1 mm amplitude
Material of construction	Stainless steel, polycarbonate end bells, Ryton® front cap
Cable	AWM Style 20387 (PVC)

Note

Ryton® is a registered trademark of Phillips Chemical (division of Phillips Petroleum).

Wiring Diagrams

Pin numbers are for reference, rely on pin location when wiring.

E57PS Performance Short Body Sensors

Operating Voltage	Output	Cable Models	Micro-Connector Models (Face View Male Shown)
Three-Wire Sensors			
10–48 Vdc	NO (NPN)		
	NO (PNP)		
	NC (NPN)		
	NC (PNP)		

Dimensions

Approximate Dimensions in Inches (mm)

E57PS Performance Short Body Sensors—Cable Models

12 mm

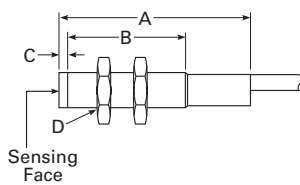

18 mm

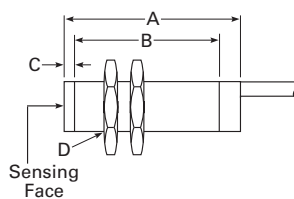

30 mm

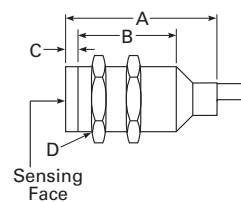

Size	Shielding	Overall Length A	Threaded Length B	Cap Height C	Thread Size D
Three-Wire DC Sensors					
12 mm	Shielded	1.61 (40.9)	1.07 (27.2)	—	M12 x 1
	Unshielded	1.61 (40.9)	0.89 (22.7)	0.20 (5.0)	M12 x 1
18 mm	Shielded	1.77 (44.9)	1.17 (29.8)	—	M18 x 1
	Unshielded	1.77 (44.9)	0.92 (23.3)	0.28 (7.0)	M18 x 1
30 mm	Shielded	1.84 (46.6)	1.15 (29.3)	—	M30 x 1.5
	Unshielded	1.84 (46.6)	0.66 (16.8)	0.51 (13.0)	M30 x 1.5

3.3

Inductive Proximity Sensors

E57PS Performance Short Body Sensors

Approximate Dimensions in Inches (mm)

E57PS Performance Short Body Sensors—Micro-Connector Models

12 mm

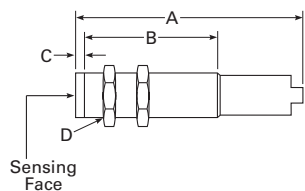

18 mm

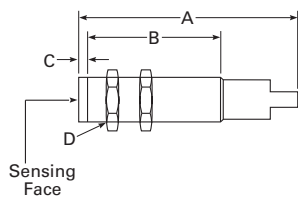

30 mm

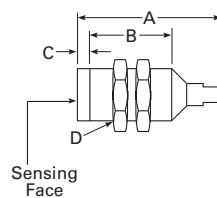

Size	Shielding	Overall Length A	Threaded Length B	Cap Height C	Thread Size D
Three-Wire DC Sensors					
12 mm	Shielded	1.64 (41.5)	1.07 (27.2)	—	M12 x 1
	Unshielded	1.64 (41.5)	0.89 (22.7)	0.20 (5.0)	M12 x 1
18 mm	Shielded	1.59 (40.3)	1.17 (29.8)	—	M18 x 1
	Unshielded	1.59 (40.3)	0.92 (23.3)	0.28 (7.0)	M18 x 1
30 mm	Shielded	1.77 (45.0)	1.15 (29.3)	—	M30 x 1.5
	Unshielded	1.96 (49.7)	0.66 (16.8)	0.51 (13.0)	M30 x 1.5

E57G General Purpose Proximity Sensors



Contents

Description	Page
E57G General Purpose Proximity Sensors	
Product Selection	
E57G General Purpose Proximity Sensors	V8-T3-30
Compatible Connector Cables	V8-T3-31
Accessories	V8-T3-31
Technical Data and Specifications	V8-T3-32
Wiring Diagrams	V8-T3-33
Dimensions	V8-T3-34

E57G General Purpose Proximity Sensors

Product Description

For global sensing applications, the E57G General Purpose series is designed for most standard inductive sensing needs. With its stainless steel tubular body, 360 degree visible LED, fast switching speed and laser-etched markings, the E57G series is an ideal cost-effective solution.

Features

- 360° LED indicator
- Stainless steel tube
- 10–30 Vdc operating voltage
- Short-circuit protection
- –25 to 70 °C temperature range
- IP67 environmental rating
- Durable laser-engraved label
- Available in cable and micro-connector styles
- Nickel-brass mounting nuts

Standards and Certifications

- cULus Listed
- CE



DANGER

THIS SENSOR IS NOT A SAFETY DEVICE AND IS NOT INTENDED TO BE USED AS A SAFETY DEVICE. This sensor is designed only to detect and read certain data in an electronic manner and perform no use apart from that, specifically no safety-related use. This sensor product does not include self-checking redundant circuitry, and the failure of this sensor product could cause either an energized or de-energized output condition, which could result in death, serious bodily injury, or property damage.

For the most current information on this product, visit our Web site: www.eaton.com

For Customer Service in the U.S. call 1-877-ETN CARE (386-2273), in Canada call 1-800-268-3578.
For Application Assistance in the U.S. and Canada call 1-800-426-9184.

3.4

Inductive Proximity Sensors



E57G General Purpose Proximity Sensors

Product Selection

E57G General Purpose Proximity Sensors

3

Three-Wire Sensors

	Operating Voltage	Sensing Range	Shielding	Output Type	Connection Type	NO Output Catalog Number	NC Output Catalog Number		
12 mm 	12 mm Diameter								
	10–30 Vdc	2 mm (standard range)	Shielded	PNP	2-meter cable	E57G-12SPN2-C2	E57G-12SPC2-C2		
					4-pin micro DC connector	E57G-12SPN2-Q	E57G-12SPC2-Q		
				NPN	2-meter cable	E57G-12SNN2-C2	E57G-12SNC2-C2		
					4-pin micro DC connector	E57G-12SNN2-Q	E57G-12SNC2-Q		
				4 mm (standard range)	Unshielded	PNP	2-meter cable	E57G-12UPN4-C2	E57G-12UPC4-C2
							4-pin micro DC connector	E57G-12UPN4-Q	E57G-12UPC4-Q
	NPN	2-meter cable	E57G-12UNN4-C2			E57G-12UNC4-C2			
		4-pin micro DC connector	E57G-12UNN4-Q			E57G-12UNC4-Q			
	4 mm (extended range)	Shielded	PNP	2-meter cable	E57G-12SPN4-C2	E57G-12SPC4-C2			
				4-pin micro DC connector	E57G-12SPN4-Q	E57G-12SPC4-Q			
			NPN	2-meter cable	E57G-12SNN4-C2	E57G-12SNC4-C2			
				4-pin micro DC connector	E57G-12SNN4-Q	E57G-12SNC4-Q			
			8 mm (extended range)	Unshielded	PNP	2-meter cable	E57G-12UPN8-C2	E57G-12UPC8-C2	
						4-pin micro DC connector	E57G-12UPN8-Q	E57G-12UPC8-Q	
	NPN	2-meter cable			E57G-12UNN8-C2	E57G-12UNC8-C2			
		4-pin micro DC connector			E57G-12UNN8-Q	E57G-12UNC8-Q			
	18 mm 	18 mm Diameter							
10–30 Vdc		5 mm (standard range)	Shielded	PNP	2-meter cable	E57G-18SPN5-C2	E57G-18SPC5-C2		
					4-pin micro DC connector	E57G-18SPN5-Q	E57G-18SPC5-Q		
				NPN	2-meter cable	E57G-18SNN5-C2	E57G-18SNC5-C2		
					4-pin micro DC connector	E57G-18SNN5-Q	E57G-18SNC5-Q		
				8 mm (standard range)	Unshielded	PNP	2-meter cable	E57G-18UPN8-C2	E57G-18UPC8-C2
							4-pin micro DC connector	E57G-18UPN8-Q	E57G-18UPC8-Q
		NPN	2-meter cable			E57G-18UNN8-C2	E57G-18UNC8-C2		
			4-pin micro DC connector			E57G-18UNN8-Q	E57G-18UNC8-Q		
		8 mm (extended range)	Shielded	PNP	2-meter cable	E57G-18SPN8-C2	E57G-18SPC8-C2		
					4-pin micro DC connector	E57G-18SPN8-Q	E57G-18SPC8-Q		
				NPN	2-meter cable	E57G-18SNN8-C2	E57G-18SNC8-C2		
					4-pin micro DC connector	E57G-18SNN8-Q	E57G-18SNC8-Q		
12 mm (extended range)				Unshielded	PNP	2-meter cable	E57G-18UPN12-C2	E57G-18UPC12-C2	
						4-pin micro DC connector	E57G-18UPN12-Q	E57G-18UPC12-Q	
		NPN	2-meter cable		E57G-18UNN12-C2	E57G-18UNC12-C2			
			4-pin micro DC connector		E57G-18UNN12-Q	E57G-18UNC12-Q			

Note

⊕⊖ See listing of compatible connector cables on **Page V8-T3-31**.

Three-Wire Sensors, continued

30 mm



Operating Voltage	Sensing Range	Shielding	Output Type	Connection Type	NO Output Catalog Number	NC Output Catalog Number
30 mm Diameter						
10–30 Vdc	10 mm (standard range)	Shielded	PNP	2-meter cable	E57G-30SPN10-C2	E57G-30SPC10-C2
				4-pin micro DC connector	E57G-30SPN10-Q	E57G-30SPC10-Q
		Unshielded	NPN	2-meter cable	E57G-30SNN10-C2	E57G-30SNC10-C2
				4-pin micro DC connector	E57G-30SNN10-Q	E57G-30SNC10-Q
	15 mm (standard range)	Unshielded	PNP	2-meter cable	E57G-30UPN15-C2	E57G-30UPC15-C2
				4-pin micro DC connector	E57G-30UPN15-Q	E57G-30UPC15-Q
		Unshielded	NPN	2-meter cable	E57G-30UNN15-C2	E57G-30UNC15-C2
				4-pin micro DC connector	E57G-30UNN15-Q	E57G-30UNC15-Q
	15 mm (extended range)	Shielded	PNP	2-meter cable	E57G-30SPN15-C2	E57G-30SPC15-C2
				4-pin micro DC connector	E57G-30SPN15-Q	E57G-30SPC15-Q
		Shielded	NPN	2-meter cable	E57G-30SNN15-C2	E57G-30SNC15-C2
				4-pin micro DC connector	E57G-30SNN15-Q	E57G-30SNC15-Q
22 mm (extended range)	Unshielded	PNP	2-meter cable	E57G-30UPN22-C2	E57G-30UPC22-C2	
			4-pin micro DC connector	E57G-30UPN22-Q	E57G-30UPC22-Q	
	Unshielded	NPN	2-meter cable	E57G-30UNN22-C2	E57G-30UNC22-C2	
			4-pin micro DC connector	E57G-30UNN22-Q	E57G-30UNC22-Q	

Compatible Connector Cables

Standard Cables ^①

Micro-Style Straight Female



Voltage Style	Number of Pins	Gauge	Length	Pin Configuration/Wire Colors (Face View Female Shown)	PVC Jacket Catalog Number	PUR Jacket Catalog Number
Micro-Style, Straight Female						
DC	4-pin, 3-wire	22 AWG	6.0 ft (2m)	<p>1-Brown 2-No Wire 3-Blue 4-Black</p>	CSDS4A3CY2202	CSDS4A3RY2202

Accessories

E57G General Purpose Proximity Sensors

Description	Reference
Mounting brackets	See Tab 8, section 8.2
Replacement mounting nuts and other accessories	See Tab 8, section 8.3
Connector cables	See Tab 10, section 10.1

Notes

- ⊕ See listing of compatible connector cables on **Page V8-T3-31**.
- ① For a full selection of connector cables, see **Tab 10, section 10.1**.

Technical Data and Specifications

E57G General Purpose Proximity Sensors

Description	Three-Wire DC Sensors
Operating voltage	10–30 Vdc
Output current (continuous)	100 mA
Switching frequency [Hz]	Standard range: 12 mm—Shielded: 2000; Unshielded: 2000 18 mm—Shielded: 1200; Unshielded: 1200 30 mm—Shielded: 600; Unshielded: 500 Extended range: 12 mm—Shielded: 1200; Unshielded: 500 18 mm—Shielded: 300; Unshielded: 300 30 mm—Shielded: 400; Unshielded: 200
Leakage current	<100 μ A
Output voltage drop [Vsat]	<2.5 V
Current consumption	<10 mA
Short-circuit protection	Yes (Auto Reset)
Hysteresis [% of Sr]	2–20%
Repeat accuracy	1% shielded, 3% unshielded
Time delay before availability	<200 ms
Output indicator LED	360° amber LED
Operating temperature range	–25 to 70 °C
Ingress protection	IEC IP67, UL Type 1
Mechanical shock	IEC 60947-5-2 30 G half-sine wave, 11 mS
Vibration	IEC 60947-5-2 10–55 Hz, 1 mm amplitude
Housing materials	Front face: Ryton Tube: stainless steel End bells: M12 body: Polycarbonate Cable end bell: Polycarbonate Nuts: Ni-Brass
Cable	AWM style 20387 (PVC)

Wiring Diagrams

Pin numbers are for reference, rely on pin location when wiring.

E57G General Purpose Proximity Sensors

Operating Voltage	Output	Cable Models	Connector Models (Face View Male Shown) Micro
Three-Wire Sensors			
10–30 Vdc	NO (NPN)		
	NO (PNP)		
	NC (NPN)		
	NC (PNP)		

3.4

Inductive Proximity Sensors

E57G General Purpose Proximity Sensors

Dimensions

Approximate Dimensions in Inches (mm)

E57G General Purpose Proximity Sensors

3

Cable Models

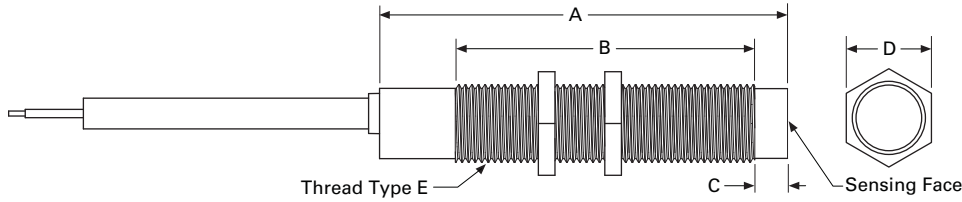

Connector Models

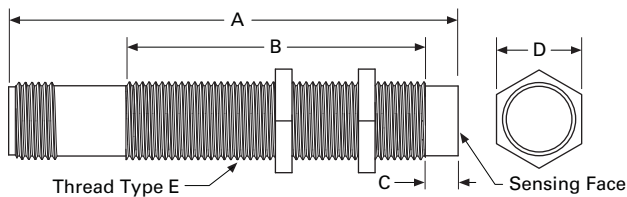

Size	Shielding	Overall Length A	Threaded Length B	Cap Height C	Nut Width D	Thread Size E
Three-Wire DC Sensors—Cable Models						
12 mm	Shielded	2.52 (64.1)	1.98 (50.3)	—	0.67 (16.8)	M12 x 1
	Unshielded	2.52 (64.1)	1.80 (45.8)	0.20 (5.0)	0.67 (16.8)	M12 x 1
18 mm	Shielded	2.59 (65.9)	2.00 (50.9)	—	0.94 (23.8)	M18 x 1
	Unshielded	2.59 (65.9)	1.75 (44.4)	0.28 (7.0)	0.94 (23.8)	M18 x 1
30 mm	Shielded	2.67 (67.7)	1.98 (50.3)	—	1.41 (35.9)	M30 x 1.5
	Unshielded	2.67 (67.7)	1.49 (37.8)	0.51 (13.0)	1.41 (35.9)	M30 x 1.5
Three-Wire DC Sensors—Micro-Connector Models						
12 mm	Shielded	2.70 (68.7)	1.98 (50.3)	—	0.67 (16.8)	M12 x 1
	Unshielded	2.70 (68.7)	1.80 (45.8)	0.20 (5.0)	0.67 (16.8)	M12 x 1
18 mm	Shielded	2.72 (69.2)	2.00 (50.9)	—	0.94 (23.8)	M18 x 1
	Unshielded	2.72 (69.2)	1.75 (44.4)	0.28 (7.0)	0.94 (23.8)	M18 x 1
30 mm	Shielded	2.79 (70.9)	1.98 (50.3)	—	1.41 (35.9)	M30 x 1.5
	Unshielded	2.79 (70.9)	1.49 (37.8)	0.51 (13.0)	1.41 (35.9)	M30 x 1.5

E57 Two-Wire (AC, AC/DC, DC) Proximity Sensors



E57 Two-Wire (AC, AC/DC, DC) Proximity Sensors

Product Description

Eaton carries several options for your sensing needs in the E57 two-wire family. The stainless steel models are available in a standard length or short body, while available in AC or AC/DC configurations. The nickel-brass body models are available in standard length and either AC or DC two-wire configurations.

All of these are available in NPN or PNP with cable connections or micro connectors. The stainless steel standard length models are also available with mini connectors.

The stainless steel models in both lengths have 360 degree LEDs while the nickel-brass models have a single LED indicator.

Extended sensing ranges are also available in the stainless steel and nickel-brass standard length models, while shielded and unshielded models are offered throughout the E57 two-wire sensor products.

Contents

Description

E57 Two-Wire (AC, AC/DC, DC) Proximity Sensors

Product Selection

Stainless Steel Body (Standard Length) . . .

V8-T3-36

Stainless Steel Short Body

V8-T3-38

Nickel-Brass Body

V8-T3-39

Compatible Connector Cables

V8-T3-40

Accessories

V8-T3-40

Technical Data and Specifications

V8-T3-41

Wiring Diagrams

V8-T3-43

Dimensions

V8-T3-45

Standards and Certifications

Stainless steel body:

- cULus Listed
- CE (AC/DC models only)



Nickel-brass body:

- cCSAus
- CE (DC models only)



⚠ DANGER

THIS SENSOR IS NOT A SAFETY DEVICE AND IS NOT INTENDED TO BE USED AS A SAFETY DEVICE. This sensor is designed only to detect and read certain data in an electronic manner and perform no use apart from that, specifically no safety-related use. This sensor product does not include self-checking redundant circuitry, and the failure of this sensor product could cause either an energized or de-energized output condition, which could result in death, serious bodily injury, or property damage.

Highlighted Comparisons

Description	Stainless Steel	Stainless Steel Short Body	Nickel-Brass
Current ratings	250–500 mA	250–500 mA	200 mA
Enclosure ratings	NEMA 4, 4K, 6, 6P, 12, 13, IEC IP6, IP69K7	NEMA 4, 4K, 6, 6P, 12, 13, IEC IP67	IP67, IP69K
Operating temperature	–25 to 70 °C	–25 to 70 °C	–25 to 70 °C
Indicator	360° LED	360° LED	LED
Increased shock and vibration ratings	Yes	Yes	No

For the most current information on this product, visit our Web site: www.eaton.com



For Customer Service in the U.S. call 1-877-ETN CARE (386-2273), in Canada call 1-800-268-3578. For Application Assistance in the U.S. and Canada call 1-800-426-9184.

Product Selection

Stainless Steel Body (Standard Length)

3

Two-Wire Sensors

	Operating Voltage	Sensing Range (Sn)	Shielding	Connection Type ^①	NO Output Catalog Number	NC Output Catalog Number	
12 mm 	12 mm Diameter End Sensing						
	20–250 Vac	2 mm (standard range)	Shielded	2-meter cable	E57LAL12A2	E57LBL12A2	
				3-pin micro AC connector	E57LAL12A2SA ☹	E57LBL12A2SA ☹	
				3-pin micro AC pigtail connector	E57LAL12A2SP ☹	E57LBL12A2SP ☹	
		4 mm (standard range)	Unshielded	2-meter cable	E57LAL12A2E	E57LBL12A2E	
				3-pin micro AC connector	E57LAL12A2EA ☹	E57LBL12A2EA ☹	
				3-pin micro AC pigtail connector	E57LAL12A2EP ☹	E57LBL12A2EP ☹	
	20–132 Vac	6 mm (extended range)	Semi-shielded	2-meter cable	E57-12LE06-A	E57-12LE06-A1	
				3-pin micro AC connector	E57-12LE06-AA ☹	E57-12LE06-A1A ☹	
				3-pin micro AC pigtail connector	E57-12LE06-AP ☹	—	
		10 mm (extended range)	Non-embeddable	2-meter cable	E57-12LE10-A	E57-12LE10-A1	
				3-pin micro AC connector	E57-12LE10-AA ☹	E57-12LE10-A1A ☹	
				3-pin micro AC pigtail connector	E57-12LE10-AP ☹	E57-12LE10-A1P ☹	
	40–250 Vac 50/60 Hz ^② 20–250 Vdc	2 mm (standard range)	Shielded	2-meter cable	E57SAL12A2	E57SBL12A2	
				3-pin micro AC connector	E57SAL12A2SA ☹	E57SBL12A2SA ☹	
				3-pin mini-connector	E57MAL12A2B1 ☹	—	
4 mm (standard range)		Unshielded	2-meter cable	E57SAL12A2E	E57SBL12A2E		
			3-pin micro AC connector	E57SAL12A2EA ☹	E57SBL12A2EA ☹		
			3-pin micro AC connector	E57SAL12A2EA ☹	E57SBL12A2EA ☹		
18 mm 	18 mm Diameter End Sensing						
	20–250 Vac	5 mm (standard range)	Shielded	2-meter cable	E57LAL18A2	E57LBL18A2	
				3-pin micro AC connector	E57LAL18A2SA ☹	E57LBL18A2SA ☹	
				3-pin micro AC pigtail connector	E57LAL18A2SP ☹	E57LBL18A2SP ☹	
				3-pin mini-connector	E57MAL18A2B1 ☹	E57MBL18A2B1 ☹	
		8 mm (standard range)	Unshielded	2-meter cable	E57LAL18A2E	E57LBL18A2E	
				3-pin micro AC connector	E57LAL18A2EA ☹	E57LBL18A2EA ☹	
				3-pin micro AC pigtail connector	E57LAL18A2EP ☹	E57LBL18A2EP ☹	
				3-pin mini-connector	E57MAL18A2EB1 ☹	E57MBL18A2EB1 ☹	
		20–132 Vac	12 mm (extended range)	Semi-shielded	2-meter cable	E57-18LE12-A	E57-18LE12-A1
					3-pin micro AC connector	E57-18LE12-AA ☹	E57-18LE12-A1A ☹
					3-pin micro AC pigtail connector	E57-18LE12-AP ☹	E57-18LE12-A1P ☹
					3-pin mini-connector	E57-18LE12-AB ☹	E57-18LE12-A1B ☹
	18 mm (extended range)		Non-embeddable	2-meter cable	E57-18LE20-A	E57-18LE20-A1	
				3-pin micro AC connector	E57-18LE20-AA ☹	E57-18LE20-A1A ☹	
				3-pin micro AC pigtail connector	E57-18LE20-AP ☹	E57-18LE20-A1P ☹	
				3-pin mini-connector	E57-18LE20-AB ☹	E57-18LE20-A1B ☹	
	40–250 Vac 50/60 Hz ^② 20–250 Vdc	5 mm (standard range)	Shielded	2-meter cable	E57SAL18A2	E57SBL18A2	
				3-pin micro AC connector	E57SAL18A2SA ☹	E57SBL18A2SA ☹	
		8 mm (standard range)	Unshielded	2-meter cable	E57SAL18A2E	E57SBL18A2E	
				3-pin micro AC connector	E57SAL18A2EA ☹	E57SBL18A2EA ☹	
				3-pin micro AC connector	E57SAL18A2EA ☹	E57SBL18A2EA ☹	
				3-pin micro AC connector	E57SAL18A2EA ☹	E57SBL18A2EA ☹	

Notes



☹ See listing of compatible connector cables on **Page V8-T3-40**.

① For cable lengths longer than 2 meters, add the number of the desired length in meters to the end of the listed catalog number (for catalog numbers ending with a number, add an **S** and then the length). Examples for a 5-meter cable: E57-18LE12-A becomes E57-18LE12-A5; E57LAL12A2 becomes E57LAL12A2S5.

② Avoid wiring these AC/DC models in series as the sensors may not perform reliably. Contact Eaton's Applications Engineering at 1-800-426-9184 with questions.

Stainless Steel Body (Standard Length)

Two-Wire Sensors, continued

	Operating Voltage	Sensing Range (Sn)	Shielding	Connection Type ^①	NO Output Catalog Number	NC Output Catalog Number	
 Right Angle	18 mm Diameter Right Angle Sensing						
	20–250 Vac	5 mm	Shielded	2-meter cable	E57RAL18A2	E57RBL18A2	
				3-pin micro AC connector	E57RAL18A2SA ☺	E57RBL18A2SA ☺	
				3-pin micro AC pigtail connector	E57RAL18A2SP ☺	E57RBL18A2SP ☺	
				3-pin mini-connector	E57RAL18A2B1 ☺	E57RBL18A2B1 ☺	
	8 mm	Unshielded	2-meter cable	E57RAL18A2E	E57RBL18A2E		
			3-pin micro AC connector	E57RAL18A2EA ☺	E57RBL18A2EA ☺		
			3-pin micro AC pigtail connector	E57RAL18A2EP ☺	E57RBL18A2EP ☺		
			3-pin mini-connector	E57RAL18A2EB1 ☺	E57RBL18A2EB1 ☺		
	 30 mm	30 mm Diameter End Sensing					
20–250 Vac		10 mm (standard range)	Shielded	2-meter cable	E57LAL30A2	E57LBL30A2	
				3-pin micro AC connector	E57LAL30A2SA ☺	E57LBL30A2SA ☺	
				3-pin micro AC pigtail connector	E57LAL30A2SP ☺	E57LBL30A2SP ☺	
				3-pin mini-connector	E57MAL30A2B1 ☺	E57MBL30A2B1 ☺	
		15 mm (standard range)	Unshielded	2-meter cable	E57LAL30A2E	E57LBL30A2E	
				3-pin micro AC connector	E57LAL30A2EA ☺	E57LBL30A2EA ☺	
				3-pin micro AC pigtail connector	E57LAL30A2EP ☺	E57LBL30A2EP ☺	
				3-pin mini-connector	E57MAL30A2EB1 ☺	E57MBL30A2EB1 ☺	
		20–132 Vac	22 mm (extended range)	Semi-shielded	2-meter cable	E57-30LE22-A	E57-30LE22-A1
					3-pin micro AC connector	E57-30LE22-AA ☺	E57-30LE22-A1A ☺
					3-pin micro AC pigtail connector	E57-30LE22-AP ☺	E57-30LE22-A1P ☺
					3-pin mini-connector	E57-30LE22-AB ☺	E57-30LE22-A1B ☺
40–250 Vac 50/60 Hz ^② 20–250 Vdc		10 mm (standard range)	Shielded	2-meter cable	E57SAL30A2	E57SBL30A2	
				3-pin micro AC connector	E57SAL30A2SA ☺	E57SBL30A2SA ☺	
		15 mm (standard range)	Unshielded	2-meter cable	E57SAL30A2E	E57SBL30A2E	
				3-pin micro AC connector	E57SAL30A2EA ☺	E57SBL30A2EA ☺	

Notes

- ☺ See listing of compatible connector cables on **Page V8-T3-40**.
- ① For cable lengths longer than 2 meters, add the number of the desired length in meters to the end of the listed catalog number (for catalog numbers ending with a number, add an **S** and then the length). Examples for a 5-meter cable: E57-18LE12-A becomes E57-18LE12-A**5**; E57LAL12A2 becomes E57LAL12A2**S5**.
- ② Avoid wiring these AC/DC models in series as the sensors may not perform reliably. Contact Eaton's Applications Engineering at 1-800-426-9184 with questions.

Stainless Steel Short Body

3

Two-Wire Sensors

Operating Voltage	Sensing Range (Sn)	Shielding	Connection Type ①	NO Output Catalog Number	NC Output Catalog Number	
12 mm						
12 mm Diameter						
20–250 Vac	2 mm	Shielded	2-meter cable	E57SAL12A4	E57SBL12A4	
			3-pin micro AC connector	E57SAL12A4SA ☺	E57SBL12A4SA ☺	
	4 mm	Unshielded	2-meter cable	E57SAL12A4E	E57SBL12A4E	
			3-pin micro AC connector	E57SAL12A4EA ☺	E57SBL12A4EA ☺	
	40–250 Vac 50/60 Hz ^② 20–250 Vdc	2 mm	Shielded	2-meter cable	E57SAL12A2	E57SBL12A2
				3-pin micro AC connector	E57SAL12A2SA ☺	E57SBL12A2SA ☺
4 mm		Unshielded	2-meter cable	E57SAL12A2E	E57SBL12A2E	
			3-pin micro AC connector	E57SAL12A2EA ☺	E57SBL12A2EA ☺	
18 mm						
18 mm Diameter						
20–250 Vac	5 mm	Shielded	2-meter cable	E57SAL18A4	E57SBL18A4	
			3-pin micro AC connector	E57SAL18A4SA ☺	E57SBL18A4SA ☺	
	8 mm	Unshielded	2-meter cable	E57SAL18A4E	E57SBL18A4E	
			3-pin micro AC connector	E57SAL18A4EA ☺	E57SBL18A4EA ☺	
	40–250 Vac 50/60 Hz ^② 20–250 Vdc	5 mm	Shielded	2-meter cable	E57SAL18A2	E57SBL18A2
				3-pin micro AC connector	E57SAL18A2SA ☺	E57SBL18A2SA ☺
8 mm		Unshielded	2-meter cable	E57SAL18A2E	E57SBL18A2E	
			3-pin micro AC connector	E57SAL18A2EA ☺	E57SBL18A2EA ☺	
30 mm						
30 mm Diameter						
20–250 Vac	10 mm	Shielded	2-meter cable	E57SAL30A4	E57SBL30A4	
			3-pin micro AC connector	E57SAL30A4SA ☺	E57SBL30A4SA ☺	
	15 mm	Unshielded	2-meter cable	E57SAL30A4E	E57SBL30A4E	
			3-pin micro AC connector	E57SAL30A4EA ☺	E57SBL30A4EA ☺	
	40–250 Vac 50/60 Hz ^② 20–250 Vdc	10 mm	Shielded	2-meter cable	E57SAL30A2	E57SBL30A2
				3-pin micro AC connector	E57SAL30A2SA ☺	E57SBL30A2SA ☺
15 mm		Unshielded	2-meter cable	E57SAL30A2E	E57SBL30A2E	
			3-pin micro AC connector	E57SAL30A2EA ☺	E57SBL30A2EA ☺	

Notes



☺ See listing of compatible connector cables on **Page V8-T3-40**.

① Cable models are supplied as standard with a 2-meter cable. A 5-meter cable is available by adding **S5** to the catalog number. Example: E57SAL12T110 becomes E57SAL12T110**S5**.

② Avoid wiring these AC/DC models in series as the sensors may not perform reliably. Contact Eaton's Applications Engineering at 1-800-426-9184 with questions.

Nickel-Brass Body

Two-Wire Sensors

	Operating Voltage	Sensing Range	Shielding	Output Type	Connection Type	NO Output Catalog Number	NC Output Catalog Number	
	12 mm Diameter							
	20–250 Vac	2 mm	Shielded	—	2-meter cable	E57-12GS02-A	E57-12GS02-A1	
					3-pin micro AC connector	E57-12GS02-AAB ☺	E57-12GS02-A1AB ☺	
		4 mm	Unshielded	—	2-meter cable	E57-12GU04-A	E57-12GU04-A1	
					3-pin micro AC connector	E57-12GU04-AAB ☺	E57-12GU04-A1AB ☺	
		10–30 Vdc	2 mm	Shielded	NPN/PNP	2-meter cable	E57-12GS02-D	E57-12GS02-D1
						4-pin micro DC connector	E57-12GS02-DDB ☺	E57-12GS02-D1DB ☺
	4 mm		Unshielded	NPN/PNP	2-meter cable	E57-12GU04-D	E57-12GU04-D1	
					4-pin micro DC connector	E57-12GU04-DDB ☺	E57-12GU04-D1DB ☺	
	8 mm (extended range)			NPN/PNP	2-meter cable	E57-12GE08-D	E57-12GE08-D1	
					4-pin micro DC connector	E57-12GE08-DDB ☺	E57-12GE08-D1DB ☺	
		18 mm Diameter						
20–250 Vac		5 mm	Shielded	—	2-meter cable	E57-18GS05-A	E57-18GS05-A1	
					3-pin micro AC connector	E57-18GS05-AAB ☺	E57-18GS05-A1AB ☺	
		8 mm	Unshielded	—	2-meter cable	E57-18GU08-A	E57-18GU08-A1	
					3-pin micro AC connector	E57-18GU08-AAB ☺	E57-18GU08-A1AB ☺	
		16 mm				3-pin micro AC connector	E57-18GE16-AAB ☺	E57-18GE16-A1AB ☺
10–30 Vdc		5 mm	Shielded	NPN/PNP	2-meter cable	E57-18GS05-D	E57-18GS05-D1	
					4-pin micro DC connector	E57-18GS05-DDB ☺	E57-18GS05-D1DB ☺	
		8 mm	Unshielded	NPN/PNP	2-meter cable	E57-18GU08-D	E57-18GU08-D1	
					4-pin micro DC connector	E57-18GU08-DDB ☺	E57-18GU08-D1DB ☺	
		16 mm (extended range)			NPN/PNP	2-meter cable	E57-18GE16-D	E57-18GE16-D1
	4-pin micro DC connector					E57-18GE16-DDB ☺	E57-18GE16-D1DB ☺	
	30 mm Diameter							
	20–250 Vac	10 mm	Shielded	—	2-meter cable	E57-30GS10-A	E57-30GS10-A1	
					3-pin micro AC connector	E57-30GS10-AAB ☺	E57-30GS10-A1AB ☺	
		15 mm	Unshielded	—	2-meter cable	E57-30GU15-A	E57-30GU15-A1	
					3-pin micro AC connector	E57-30GU15-AAB ☺	E57-30GU15-A1AB ☺	
		10–30 Vdc	10 mm	Shielded	NPN/PNP	2-meter cable	E57-30GS10-D	E57-30GS10-D1
						4-pin micro DC connector	E57-30GS10-DDB ☺	E57-30GS10-D1DB ☺
	15 mm		Unshielded	NPN/PNP	2-meter cable	E57-30GU15-D	E57-30GU15-D1	
					4-pin micro DC connector	E57-30GU15-DDB ☺	E57-30GU15-D1DB ☺	
	25 mm (extended range)				NPN/PNP	2-meter cable	E57-30GE25-D	E57-30GE25-D1
						4-pin micro DC connector	E57-30GE25-DDB ☺	E57-30GE25-D1DB ☺

Note

☺☺ See listing of compatible connector cables on [Page V8-T3-40](#).

3.5

Inductive Proximity Sensors

E57 Two-Wire (AC, AC/DC, DC) Proximity Sensors

Compatible Connector Cables

Standard Cables ^①

3

Micro-Style
Straight Female



Voltage Style	Number of Pins	Gauge	Length	Pin Configuration/Wire Colors (Face View Female Shown)	PVC Jacket Catalog Number	PUR Jacket Catalog Number
Micro-Style, Straight Female						
AC	3-pin, 3-wire	22 AWG	6.0 ft (2m)	 1-Green 2-Red/Black 3-Red/White	CSAS3F3CY2202	CSAS3F3RY2202

Accessories

E57 Two-Wire Proximity Sensors

Description	Reference
Mounting brackets	See Tab 8, section 8.2
Replacement mounting nuts and other accessories	See Tab 8, section 8.3
Connector cables	See Tab 10, section 10.1

Note

^① For a full selection of connector cables, see **Tab 10, section 10.1**.

Technical Data and Specifications

Stainless Steel Body

Description	Two-Wire AC/DC Sensors		
	Two-Wire AC Sensors	AC Operation	DC Operation
Operating voltage	40–250 Vac	40–250 Vac	20–250 Vdc
Maximum load current	250 mA	200 mA	200 mA
Switching frequency	20 Hz	60 Hz	60 Hz
Leakage current	1.7 mA maximum at 70 °C	1.7V mA maximum at 120 Vac	≤2.0 mA
Voltage drop	7V maximum	≤4 V at >25 mA	12 V at <10 mA
Holding current	5 mA minimum	5 mA minimum	5 mA maximum
Protection	—	Resettable short circuit; overload protection	Resettable short circuit; overload protection
Switching hysteresis	2–20% of rated sensing distance	2–20% of rated sensing distance	2–20% of rated sensing distance
Repeat accuracy	<3% sensing distance	<3% sensing distance	<3% sensing distance
Output indicator LED	360° viewable LED	360° viewable LED	360° viewable LED
Operating temperature	–13 to 158 °F (–25 to 70 °C) ^①	–13 to 158 °F (–25 to 70 °C) ^①	–13 to 158 °F (–25 to 70 °C) ^①
Enclosure ratings	NEMA 4, 4X, 6, 6P, 12 and 13 (IP67)	NEMA 4, 4X, 6, 6P, 12 and 13 (IP67)	NEMA 4, 4X, 6, 6P, 12 and 13 (IP67)
Shock	30 g sine wave, 11 ms per IEC68-2-76	30 g sine wave, 11 ms per IEC68-2-76	30 g sine wave, 11 ms per IEC68-2-76
Vibration	10 to 55 Hz, 1 mm amplitude	10 to 55 Hz, 1 mm amplitude	10 to 55 Hz, 1 mm amplitude
Material of construction	Stainless steel, polycarbonate end bells, Ryton [®] front cap	Stainless steel, polycarbonate end bells, Ryton [®] front cap	Stainless steel, polycarbonate end bells, Ryton [®] front cap
Cable	AWM Style 20387 (PVC)	AWM Style 20387 (PVC)	AWM Style 20387 (PVC)

Notes

Ryton[®] is a registered trademark of Phillips Chemical (division of Phillips Petroleum).

^① 240 Vac operation is limited to less than 122 °F (50 °C) in two-wire AC/DC models.

3.5

Inductive Proximity Sensors

E57 Two-Wire (AC, AC/DC, DC) Proximity Sensors

3

Nickel-Brass Body

Description	Two-Wire AC Sensors	Two-Wire DC Sensors
Operating voltage	20–250 Vac	10–30 Vdc
OFF-state leakage	<1.8 mA	<0.8 mA
Maximum load current	200 mA	100 mA
Minimum load current	5 mA	3 mA
Surge current	5 A (20 ms)	—
Voltage drop	<8 Vac at 400 mA	<6 V
Switching frequency	—	—
8 mm diameter	—	—
12 mm diameter	25 Hz	1 kHz (shielded); 1 kHz (unshielded)
18 mm diameter	25 Hz	1 kHz (shielded); 500 Hz (unshielded)
30 mm diameter	25 Hz	500 Hz (shielded); 200 Hz (unshielded)
Short-circuit protection	No	Yes
Overload trip point	—	>120 mA
Time delay before availability	—	—
Transient protection	—	2 kV, 1 ms, 1 kohm
Repeat accuracy	Shielded: <1.0%/Unshielded: <3.0% (Sr)	<2.0% (Sr)
Switching hysteresis	<15%	<15%
Operating temperature	–13 to 158 °F (–25 to 70 °C) (32 to 140 °F [0 to 60 °C] for all extended range models)	–13 to 158 °F (–25 to 70 °C) (32 to 140 °F [0 to 60 °C] for all extended range models)
Temperature drift	<10% (Sr)	<10% (Sr)
Protection	IP67, IP69K	IP67, IP69K
Housing material	Nickel plated brass (stainless steel for 8 mm diameter, nano-connector models)	Nickel plated brass (stainless steel for 8 mm diameter, nano-connector models)
Cable	PVC jacket, 2-meter length	PVC jacket, 2-meter length

Recommended Mounting Clearances

For unshielded standard range sensors and extended range sensors, clearance must be provided around the sensor when mounting for reliable performance. ("Sn" is the sensing range of the sensor, "d" is the sensor diameter.)

E57 Premium Sensors, Mounting

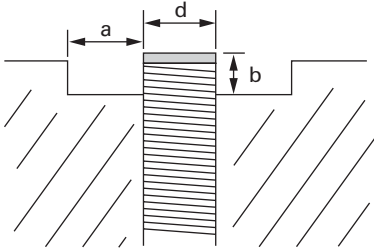

Type	Shielding	a	b
Standard range	Shielded	0	0
	Unshielded	Cap height	2 x Sn
Extended range	Semi-shielded	d	Sn
	Non-embeddable	Cap height	2 x Sn

Wiring Diagrams

Pin numbers are for reference, rely on pin location when wiring.

Stainless Steel Body

Operating Voltage	Output	Cable Models	Connector Models (Face View Male Shown)	
			Micro	Mini
Two-Wire Sensors				
20–250 Vac/dc and AC-only AC wiring example	NO and NC			
20–250 Vac/dc DC wiring example	NO and NC (NPN)			—
	NO and NC (PNP)			—

3.5

Inductive Proximity Sensors

E57 Two-Wire (AC, AC/DC, DC) Proximity Sensors

Nickel-Brass Body

Operating Voltage	Output	Cable Models	Connector Models (Face View Male Shown) Micro
Two-Wire Sensors			
20–250 Vac	NO		
10–30 Vdc	NO (NPN)		
	NO (PNP)		

Dimensions

Approximate Dimensions in Inches (mm)

Stainless Steel Body (Standard Length) ^{①②}

Cable Models

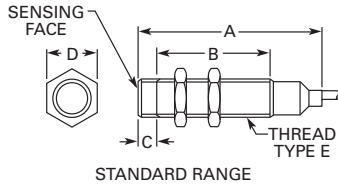

Connector Models

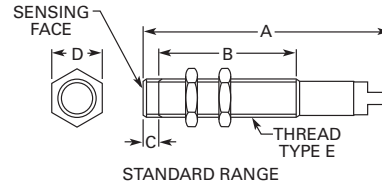

Size	Shielding	Overall Length A	Threaded Length B	Cap Height C	Nut Width D	Thread Size E
Two-Wire AC Sensors—Cable Models						
12 mm	Shielded	2.46 (62.4)	1.98 (50.3)	—	0.67 (16.8)	M12 x 1
	Semi-shielded	2.87 (72.8)	2.28 (57.9)	0.06 (1.62)	0.67 (16.8)	M12 x 1
	Unshielded	2.87 (72.7)	1.98 (50.3)	0.36 (9.14)	0.67 (16.8)	M12 x 1
18 mm	Shielded	2.54 (64.5)	2.00 (50.9)	—	0.94 (23.8)	M18 x 1
	Semi-shielded	2.60 (66.1)	1.90 (48.2)	0.10 (2.54)	0.94 (23.8)	M18 x 1
	Unshielded	2.60 (66.0)	1.47 (37.2)	0.56 (14.1)	0.94 (23.8)	M18 x 1
30 mm	Shielded	2.73 (69.3)	1.98 (50.3)	—	1.41 (35.9)	M30 x 1.5
	Semi-shielded	2.67 (67.8)	1.90 (48.2)	0.13 (3.30)	1.41 (35.9)	M30 x 1.5
	Unshielded	2.73 (69.3)	1.49 (37.8)	0.52 (13.26)	1.41 (35.9)	M30 x 1.5
Two-Wire AC Sensors—Micro-Connector Models						
12 mm	Shielded	2.69 (68.4)	1.98 (50.3)	—	0.67 (16.8)	M12 x 1
	Semi-shielded	3.04 (77.2)	2.28 (57.9)	0.06 (1.62)	0.67 (16.8)	M12 x 1
	Unshielded	3.06 (77.7)	1.98 (50.3)	0.36 (9.14)	0.36 (9.14)	M12 x 1
18 mm	Shielded	2.72 (69.06)	2.00 (50.9)	—	0.94 (23.8)	M18 x 1
	Semi-shielded	2.72 (69.1)	1.90 (48.2)	0.10 (2.54)	0.94 (23.8)	M18 x 1
	Unshielded	2.74 (69.4)	1.47 (37.2)	0.56 (14.1)	0.94 (23.8)	M18 x 1
30 mm	Shielded	2.91 (73.8)	1.98 (50.3)	—	1.41 (35.9)	M30 x 1.5
	Semi-shielded	2.78 (70.6)	1.90 (48.2)	0.13 (3.30)	1.41 (35.9)	M30 x 1.5
	Unshielded	2.91 (73.8)	1.49 (37.8)	0.52 (13.26)	1.41 (35.9)	M30 x 1.5

Notes

- ① These dimensions apply to the Premium+ Series models in this section. Not indicated Premium Series models.
- ② For short body model dimensions (E57SAL ...) refer to **Page V8-T3-24**.

3.5

Inductive Proximity Sensors

E57 Two-Wire (AC, AC/DC, DC) Proximity Sensors

Approximate Dimensions in Inches (mm)

Stainless Steel Body (Standard Length) ①②

Cable Models, continued

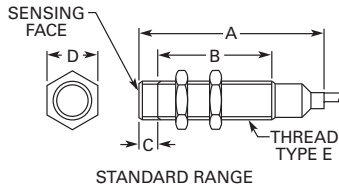

Connector Models, continued

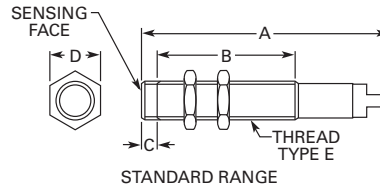

Size	Shielding	Overall Length A	Threaded Length B	Cap Height C	Nut Width D	Thread Size E
Two-Wire AC/DC Sensors—Cable Models						
12 mm	Shielded	2.45 (62.4)	1.98 (50.3)	—	0.67 (16.8)	M12 x 1
	Unshielded	2.45 (62.4)	1.80 (45.8)	0.20 (5)	0.67 (16.8)	M12 x 1
18 mm	Shielded	2.54 (64.5)	2.00 (50.9)	—	0.94 (23.8)	M18 x 1
	Unshielded	2.54 (64.5)	1.75 (44.4)	0.28 (7)	0.94 (23.8)	M18 x 1
30 mm	Shielded	2.72 (69.3)	2.12 (53.8)	—	1.41 (35.9)	M30 x 1.5
	Unshielded	2.72 (69.3)	1.63 (41.4)	0.52 (13.26)	1.41 (35.9)	M30 x 1.5
Two-Wire AC/DC Sensors—Micro-Connector Models						
12 mm	Shielded	2.69 (68.4)	1.98 (50.3)	—	0.67 (16.8)	M12 x 1
	Unshielded	2.69 (68.4)	1.80 (45.8)	0.20 (5)	0.67 (16.8)	M12 x 1
18 mm	Shielded	2.72 (69.06)	2.00 (50.9)	—	0.94 (23.8)	M18 x 1
	Unshielded	2.72 (69.06)	1.75 (44.4)	0.28 (7)	0.94 (23.8)	M18 x 1
30 mm	Shielded	2.91 (73.8)	1.98 (50.3)	—	1.41 (35.9)	M30 x 1.5
	Unshielded	2.91 (73.8)	1.49 (37.8)	0.52 (13.26)	1.41 (35.9)	M30 x 1.5
Two-Wire AC Sensors—Mini-Connector Models						
18 mm	Shielded	3.39 (86.1)	2.00 (50.8)	0.02 (0.5)	0.94 (23.8)	M18 x 1
	Semi-shielded	3.39 (86.0)	1.90 (48.2)	0.10 (2.54)	0.94 (23.8)	M18 x 1
	Unshielded	3.39 (86.1)	1.46 (37.0)	0.57 (14.5)	0.94 (23.8)	M18 x 1
30 mm	Shielded	3.39 (86.1)	2.1 (53.3)	0.03 (0.8)	1.41 (35.9)	M30 x 1.5
	Semi-shielded	3.44 (87.4)	1.90 (48.2)	0.13 (3.30)	1.41 (35.9)	M30 x 1.5
	Unshielded	3.39 (86.1)	1.55 (39.4)	0.55 (14.0)	1.41 (35.9)	M30 x 1.5

Notes

① These dimensions apply to the Premium+ Series models in this section. Not indicated Premium Series models.

② For short body model dimensions (E57SAL ...) refer to **Page V8-T3-24**.

Approximate Dimensions in Inches (mm)

Stainless Steel Short Body (Cable Connector Models)

12 mm

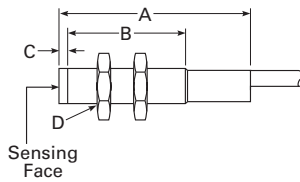

18 mm

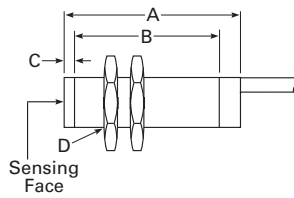

30 mm

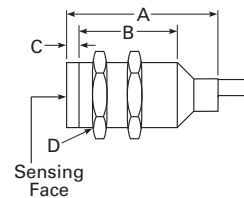

Size	Shielding	Overall Length A	Threaded Length B	Cap Height C	Thread Size D
Two-Wire AC Sensors					
12 mm	Shielded	2.04 (51.7)	1.56 (39.6)	0.02 (0.5)	M12 x 1
	Unshielded	2.04 (51.7)	1.38 (35.1)	0.20 (5)	M12 x 1
18 mm	Shielded	1.39 (35.3)	0.86 (21.82)	0.02 (0.5)	M18 x 1
	Unshielded	1.39 (35.3)	0.60 (15.32)	0.28 (7)	M18 x 1
30 mm	Shielded	1.58 (40.2)	0.99 (25.15)	0.03 (0.8)	M30 x 1.5
	Unshielded	1.77 (44.9)	0.68 (17.27)	0.52 (13.26)	M30 x 1.5
Two-Wire AC/DC Sensors					
12 mm	Shielded	2.46 (62.4)	1.98 (50.27)	—	M12 x 1
	Unshielded	2.46 (62.4)	1.80 (45.77)	0.20 (5)	M12 x 1
18 mm	Shielded	2.54 (64.5)	2.00 (50.9)	—	M18 x 1
	Unshielded	2.54 (64.5)	1.75 (44.4)	0.28 (7)	M18 x 1
30 mm	Shielded	2.72 (69.3)	2.12 (53.8)	—	M30 x 1.5
	Unshielded	2.72 (69.3)	1.63 (41.4)	0.52 (13.26)	M30 x 1.5

Stainless Steel Short Body (Micro-Connector Models)

12 mm

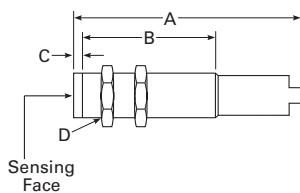

18 mm

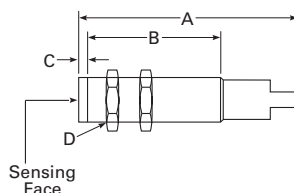

30 mm

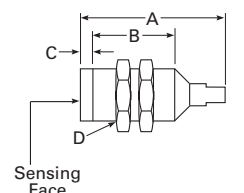

Size	Shielding	Overall Length A	Threaded Length B	Cap Height C	Thread Size D
Two-Wire AC Sensors					
12 mm	Shielded	2.27 (57.8)	1.56 (39.6)	0.02 (0.5)	M12 x 1
	Unshielded	2.27 (57.8)	1.38 (35.1)	0.20 (5)	M12 x 1
18 mm	Shielded	1.57 (40.0)	0.86 (21.82)	0.02 (0.5)	M18 x 1
	Unshielded	1.57 (40.0)	0.60 (15.32)	0.28 (7)	M18 x 1
30 mm	Shielded	1.76 (44.8)	0.99 (25.15)	0.03 (0.8)	M30 x 1.5
	Unshielded	1.95 (49.5)	0.68 (17.27)	0.52 (13.26)	M30 x 1.5
Two-Wire AC/DC Sensors					
12 mm	Shielded	2.69 (68.4)	1.98 (50.27)	—	M12 x 1
	Unshielded	2.69 (68.4)	1.80 (45.77)	0.20 (5)	M12 x 1
18 mm	Shielded	2.72 (69.06)	2.00 (50.9)	—	M18 x 1
	Unshielded	2.72 (69.06)	1.75 (44.4)	0.28 (7)	M18 x 1
30 mm	Shielded	2.91 (73.8)	2.12 (53.8)	—	M30 x 1.5
	Unshielded	2.91 (73.8)	1.63 (41.4)	0.52 (13.26)	M30 x 1.5

3.5

Inductive Proximity Sensors

E57 Two-Wire (AC, AC/DC, DC) Proximity Sensors

Approximate Dimensions in mm

Nickel-Brass Body

Cable Models

3

Two-Wire Sensors

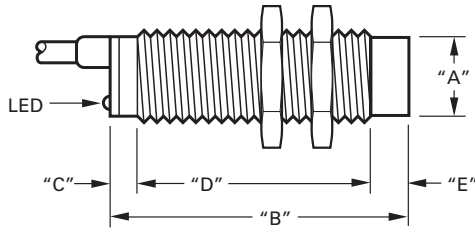

Catalog Number	Operating Voltage	A	B	C	D	E
E57-12GS02-A	20–250 Vac	M12x1	65	15	50	—
E57-12GU04-A		M12x1	60	15	42	8
E57-18GS05-A		M18x1	80	20	60	—
E57-18GU08-A		M18x1	80	20	48	12
E57-30GS10-A		M30x1.5	80	20	60	—
E57-30GU15-A		M30x1.5	80	20	45	15
E57-12GS02-D	10–30 Vdc	M12x1	50	—	50	—
E57-12GU04-D		M12x1	50	—	42	8
E57-12GE08-D		M12x1	50	—	42	8
E57-12GE08-D1		M12x1	50	—	42	8
E57-18GS05-D		M18x1	55	5	50	—
E57-18GU08-D		M18x1	55	5	38	12
E57-18GE16-D		M18x1	55	5	38	12
E57-18GE16-D1		M18x1	55	5	38	12
E57-30GS10-D		M30x1.5	55	5	50	—
E57-30GU15-D		M30x1.5	55	5	35	15
E57-30GE25-D		M30x1.5	55	5	35	15
E57-30GE25-D1		M30x1.5	55	5	35	15

Connector Models

Two-Wire Sensors

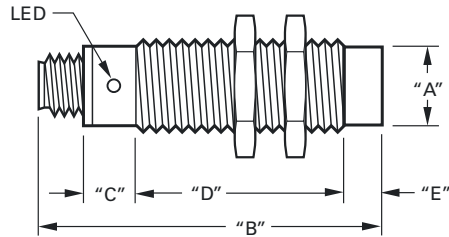

Catalog Number ^①	Operating Voltage	A	B	C	D	E
E57-12GS02-AAB	20–250 Vac	M12x1	68	16	42	—
E57-12GU04-AAB		M12x1	68	16	34	8
E57-18GS05-AAB		M18x1	91	20	60	—
E57-18GU08-AAB		M18x1	91	20	48	12
E57-18GE16-AAB		M18x1	79.2	15	37	11.5
E57-30GS10-AAB		M30x1.5	80	20	60	—
E57-30GU15-AAB		M30x1.5	91	20	45	15
E57-12GS02-DDB	10–30 Vdc	M12x1	69	16	42	—
E57-12GU04-DDB		M12x1	68	16	34	8
E57-12GE08-DDB		M12x1	68	10	50	8
E57-12GE08-D1DB		M12x1	68	10	50	8
E57-18GS05-DDB		M18x1	76	15	61	—
E57-18GU08-DDB		M18x1	80	15	49	12
E57-18GE16-DDB		M18x1	79	15	52	12
E57-30GS10-DDB		M30x1.5	75	15	60	—
E57-30GU15-DDB		M30x1.5	79	15	45	15
E57-30GE25-DDB		M30x1.5	78	15	48	15

Note

① Normally closed models are dimensionally indicated to equivalent normally open models.

AccuProx Analog Sensors



AccuProx Analog Sensors

Product Description

The AccuProx from Eaton's Electrical Sector is a high performance analog inductive proximity sensor. The AccuProx family of analog sensors provide unmatched sensing range, linearity and resolution in an affordable and compact tubular package.

Unlike standard inductive sensors, which send an open or close signal upon target presence or absence, AccuProx analog sensors provide an electrical signal that varies in proportion to the position of the metal target within its sensing range. This makes AccuProx ideal for applications requiring precise position sensing and measurement.

The sensing performance of AccuProx sets it apart from traditional analog inductive designs. Utilizing components from the cutting-edge iProx family, AccuProx provides sensing ranges of three to four times that of typical tubular analog inductive sensors—all without compromising accuracy.

Unlike many competitive products, which are often hampered by an "S-shaped" output curve, AccuProx outputs are linear.

AccuProx has the range and precision to solve your most difficult measurement applications.

Application Description

Typical Applications

- Part positioning
- Distance, size and thickness measurement
- General inspection and error proofing, such as material imperfection or blemish detection
- Eccentricity or absolute angle detection
- Identification of different metals

See the Application Guide on **Page V8-T3-50** for more detail.

Contents

Description	Page
AccuProx Analog Sensors	
Application Guide	V8-T3-50
Product Selection	
AccuProx Analog Sensors	V8-T3-51
Compatible Connector Cables	V8-T3-51
Technical Data and Specifications	V8-T3-52
Wiring Diagrams	V8-T3-54
Dimensions	V8-T3-54

Features

- Extended linear sensing range of up to 25 millimeters—three times longer than standard tubular analog inductive sensors
- Outputs available in current (4–20 or 0–20 mA) and voltage (0–10 V)
- High output resolution and repeatability for applications requiring precision sensing performance
- Robust stainless steel barrel, shock-resistant front cap, polycarbonate end bell and impact-absorbing potting compound
- Ideal for extreme temperature or high pressure washdown environments
- High noise immunity of 20 V/m prevents many problems associated with electrical noise

Standards and Certifications

- cUL Listed
- CE



⚠ DANGER

THIS SENSOR IS NOT A SAFETY DEVICE AND IS NOT INTENDED TO BE USED AS A SAFETY DEVICE. This sensor is designed only to detect and read certain data in an electronic manner and perform no use apart from that, specifically no safety-related use. This sensor product does not include self-checking redundant circuitry, and the failure of this sensor product could cause either an energized or de-energized output condition, which could result in death, serious bodily injury, or property damage.

For the most current information on this product, visit our Web site: www.eaton.com

For Customer Service in the U.S. call 1-877-ETN CARE (386-2273), in Canada call 1-800-268-3578.
For Application Assistance in the U.S. and Canada call 1-800-426-9184.

3.6

Inductive Proximity Sensors

AccuProx Analog Sensors

Application Guide

Presenting AccuProx—Unmatched Analog Range in a Proven Package

3

Historically, analog sensors have been limited by very short sensing ranges—as little as one or two millimeters. By utilizing technology first perfected in the iProx family of digital inductive sensors, AccuProx can sense objects as far as 25 millimeters. This extended range can be achieved without making compromises often found in competitive products, such as reduced output accuracy.

AccuProx utilizes many of the proven materials found in other tubular sensor families. The threaded barrel and included mounting nuts are made of stainless steel, which exhibits superior corrosion and abrasion resistance versus nickel-plated brass. AccuProx also features a proprietary internal potting compound that absorbs impacts and vibration while sealing out moisture. The materials used in the construction of AccuProx are time-tested and proven to work.

High Output Accuracy

Analog inductive sensors are often used in applications that require a higher level of precision than a standard digital sensor. For example, applications such as part inspection require a sensor that can detect very small variances. AccuProx has been designed with these applications in mind.

Output accuracy is determined by the repeat accuracy, linearity, resolution and response time of the sensor.

Repeat accuracy refers to the variations in sensing distance between successive sensor operations due to component tolerances, where all operating conditions are kept the same. The repeat accuracy of an 18 millimeter, unshielded AccuProx sensor is less than 20 micrometers. See the chart below for a repeat accuracy comparison of AccuProx versus the competition.

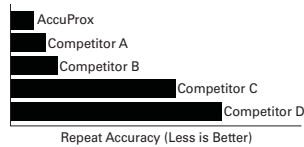

Linearity refers to the shape of the output curve. Many competitive analog sensors exhibit a wavy or “S-shaped” output curve. This means that a change in target distance may not always translate into an equivalent change in output, particularly at the innermost and outermost ranges of a non-linear analog sensor. AccuProx features a linear output. See the diagram below for an example of AccuProx versus a non-linear competitive offering.

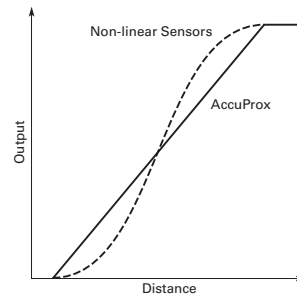

Resolution refers to the number of “steps” in the sensor output. A higher resolution is ideal because it will allow the sensor to detect smaller changes in target position.

An 18 millimeter, unshielded AccuProx features more than 350 output steps, ensuring consistent performance.

Typical Analog Applications Material Imperfection or Blemish Detection

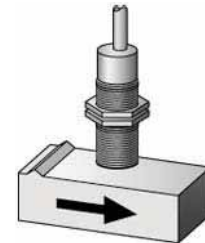

Eccentricity or Absolute Angle Detection



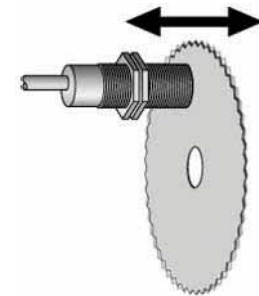

Saw Blade Deflection



Product Selection



AccuProx Analog Sensors

Three-/Four-Wire Sensors

	Operating Voltage	Sensing Range ①	Shielding	Connection Type	Current (0–20 mA) and Voltage (0–10 V) Output ② Catalog Number	Current (4–20 mA) Output Only ② Catalog Number
12 mm 	12 mm Diameter					
	15–30 Vdc	0.5–4 mm	Shielded	4-pin micro DC connector	E59-A12A104D01-CV ☹	E59-A12A104D01-C1 ☹
				4-pin micro DC pigtail	E59-A12A104D01P-CV ☹	E59-A12A104D01P-C1 ☹
				2-meter cable	E59-A12A104C02-CV	E59-A12A104C02-C1
	1–8 mm	Unshielded	4-pin micro DC connector	E59-A12C108D01-CV ☹	E59-A12C108D01-C1 ☹	
			4-pin micro DC pigtail	E59-A12C108D01P-CV ☹	E59-A12C108D01P-C1 ☹	
2-meter cable			E59-A12C108C02-CV	E59-A12C108C02-C1		
18 mm 	18 mm Diameter					
	15–30 Vdc	1–7 mm	Shielded	4-pin micro DC connector	E59-A18A107D01-CV ☹	E59-A18A107D01-C1 ☹
				4-pin micro DC pigtail	E59-A18A107D01P-CV ☹	E59-A18A107D01P-C1 ☹
				2-meter cable	E59-A18A107C02-CV	E59-A18A107C02-C1
	1–15 mm	Unshielded	4-pin micro DC connector	E59-A18C115D01-CV ☹	E59-A18C115D01-C1 ☹	
			4-pin micro DC pigtail	E59-A18C115D01P-CV ☹	E59-A18C115D01P-C1 ☹	
2-meter cable			E59-A18C115C02-CV	E59-A18C115C02-C1		
30 mm 	30 mm Diameter					
	15–30 Vdc	1–12 mm	Shielded	4-pin micro DC connector	E59-A30A112D01-CV ☹	E59-A30A112D01-C1 ☹
				4-pin micro DC pigtail	E59-A30A112D01P-CV ☹	E59-A30A112D01P-C1 ☹
				2-meter cable	E59-A30A112C02-CV	E59-A30A112C02-C1
	1–25 mm	Unshielded	4-pin micro DC connector	E59-A30C125D01-CV ☹	E59-A30C125D01-C1 ☹	
			4-pin micro DC pigtail	E59-A30C125D01P-CV ☹	E59-A30C125D01P-C1 ☹	
2-meter cable			E59-A30C125C02-CV	E59-A30C125C02-C1		

Compatible Connector Cables

Standard Cables ③

	Voltage Style	Number of Pins	Gauge	Length	Pin Configuration/Wire Colors (Face View Female Shown)	PVC Jacket Catalog Number	PUR Jacket Catalog Number
Micro-Style Straight Female 	Micro-Style, Straight Female						
	DC	4-pin, 3-wire	22 AWG	6.0 ft (2m)	 1-Brown 2-No Wire 3-Blue 4-Black	CSDS4A3CY2202	CSDS4A3RY2202
	DC	4-pin, 4-wire	22 AWG	6.0 ft (2m)	 1-Brown 2-White 3-Blue 4-Black	CSDS4A4CY2202	CSDS4A4RY2202

Notes

- ☹ See listing of compatible connector cables above.
- ① Published range data is based on a 1 mm thick square target made of Type FE 360 steel per ISO Standard 630.
- ② Models available in custom output configurations (for example, 1–5 V, 0–5 V). Contact factory for details.
- ③ For a full selection of connector cables, see **Tab 10, section 10.1**.

Technical Data and Specifications

AccuProx Analog Sensors

3

Description	12 mm Models		18 mm Models		30 mm Models	
	Shielded	Unshielded	Shielded	Unshielded	Shielded	Unshielded
Performance						
Analog operating range ^①	0.5–4 mm	1–8 mm	1–7 mm	1–15 mm	1–12 mm	1–25 mm
Temperature range	–40 to 158 °F (–40 to 70 °C)	–40 to 158 °F (–40 to 70 °C)	–40 to 158 °F (–40 to 70 °C)	–40 to 158 °F (–40 to 70 °C)	–40 to 158 °F (–40 to 70 °C)	–40 to 158 °F (–40 to 70 °C)
Temperature drift	<± 10%	<± 10%	<± 10%	<± 10%	<± 10%	<± 10%
Conformity	<± 10%	<± 10%	<± 10%	<± 10%	<± 10%	<± 10%
Repeat accuracy	<25 μm ^②	<20 μm ^②	<40 μm ^②	<20 μm ^②	<50 μm ^②	<30 μm ^②
Minimum repeat accuracy	<3.0% at max. range	<1.1% at max. range	<2.2% at max. range	<1.2% at max. range	<1.2% at max. range	<0.8% at max. range
Recovery time	<1.0 ms	<1.1 ms	<1.5 ms	<2.0 ms	<2.0 ms	<3.0 ms
Response time	200 Hz	100 Hz	200 Hz	100 Hz	140 Hz	100 Hz
Linearity tolerance	<± 1.0% of full scale	<± 1.0% of full scale	<± 1.0% of full scale	<± 1.0% of full scale	<± 1.0% of full scale	<± 1.0% of full scale
Resolution	23 μm max.	16 μm max.	40 μm max.	21 μm max.	50 μm max.	30 μm max.
Electrical						
Style	AccuProx Analog, three-/four-wire DC	AccuProx Analog, three-/four-wire DC	AccuProx Analog, three-/four-wire DC	AccuProx Analog, three-/four-wire DC	AccuProx Analog, three-/four-wire DC	AccuProx Analog, three-/four-wire DC
Operating voltage	15–30 Vdc	15–30 Vdc	15–30 Vdc	15–30 Vdc	15–30 Vdc	15–30 Vdc
Current output signal	0–20 mA or 4–20 mA by model	0–20 mA or 4–20 mA by model	0–20 mA or 4–20 mA by model	0–20 mA or 4–20 mA by model	0–20 mA or 4–20 mA by model	0–20 mA or 4–20 mA by model
Current output load resistance	400–500 ohms	400–500 ohms	400–500 ohms	400–500 ohms	400–500 ohms	400–500 ohms
Current output ripple content	± 40 μA max.	± 40 μA max.	± 40 μA max.	± 40 μA max.	± 40 μA max.	± 40 μA max.
Current output minimum change	30 μA	20 μA	50 μA	28 μA	66 μA	40 μA
Voltage output signal ^③	0–10 V	0–10 V	0–10 V	0–10 V	0–10 V	0–10 V
Voltage output load resistance	4.7–5.0 kohm (2.5 mA max.)	4.7–5.0 kohm (2.5 mA max.)	4.7–5.0 kohm (2.5 mA max.)	4.7–5.0 kohm (2.5 mA max.)	4.7–5.0 kohm (2.5 mA max.)	4.7–5.0 kohm (2.5 mA max.)
Voltage output ripple content	± 10 mV max.	± 10 mV max.	± 10 mV max.	± 10 mV max.	± 10 mV max.	± 10 mV max.
Voltage output minimum change	15 mV	10 mV	25 mV	14 mV	33 mV	20 mV
Burden current	<20 mA	<20 mA	<20 mA	<20 mA	<20 mA	<20 mA
Output LED	Dual-color, 360° viewable	Dual-color, 360° viewable	Dual-color, 360° viewable	Dual-color, 360° viewable	Dual-color, 360° viewable	Dual-color, 360° viewable
Short-circuit protection	Incorporated ^④	Incorporated ^④	Incorporated ^④	Incorporated ^④	Incorporated ^④	Incorporated ^④
Wire breakage protection	Incorporated	Incorporated	Incorporated	Incorporated	Incorporated	Incorporated
Reverse polarity protection	Incorporated	Incorporated	Incorporated	Incorporated	Incorporated	Incorporated
Physical						
Size	See Dimensions on Page V8-T3-54 .					
Enclosure protection	NEMA 4, 4X, 6, 6P, 13	NEMA 4, 4X, 6, 6P, 13	NEMA 4, 4X, 6, 6P, 13	NEMA 4, 4X, 6, 6P, 13	NEMA 4, 4X, 6, 6P, 13	NEMA 4, 4X, 6, 6P, 13
Shock	30 g half-sine at 11 ms	30 g half-sine at 11 ms	30 g half-sine at 11 ms	30 g half-sine at 11 ms	30 g half-sine at 11 ms	30 g half-sine at 11 ms
Vibration	10–55 Hz, 1 mm amplitude	10–55 Hz, 1 mm amplitude	10–55 Hz, 1 mm amplitude	10–55 Hz, 1 mm amplitude	10–55 Hz, 1 mm amplitude	10–55 Hz, 1 mm amplitude
Housing material	Stainless steel, polycarbonate end bell, polyphenylene sulfide front cap	Stainless steel, polycarbonate end bell, polyphenylene sulfide front cap	Stainless steel, polycarbonate end bell, polyphenylene sulfide front cap	Stainless steel, polycarbonate end bell, polyphenylene sulfide front cap	Stainless steel, polycarbonate end bell, polyphenylene sulfide front cap	Stainless steel, polycarbonate end bell, polyphenylene sulfide front cap
Termination	Micro-connector, potted cable, 2m; Pigtail, micro-connector, 2m	Micro-connector, potted cable, 2m; Pigtail, micro-connector, 2m	Micro-connector, potted cable, 2m; Pigtail, micro-connector, 2m	Micro-connector, potted cable, 2m; Pigtail, micro-connector, 2m	Micro-connector, potted cable, 2m; Pigtail, micro-connector, 2m	Micro-connector, potted cable, 2m; Pigtail, micro-connector, 2m

Notes

① Published range data is based on a 1 mm thick square target made of Type FE 360 steel per ISO Standard 630.

② The sensor achieves its maximum repeat accuracy after warming up for a period of at least one hour.

③ Voltage outputs available on models ending in **-CV**.

④ Continuous short-circuits can exceed power dissipation ratings and cause eventual destruction.

AccuProx Analog Performance Graphs

Linear Output

12 mm

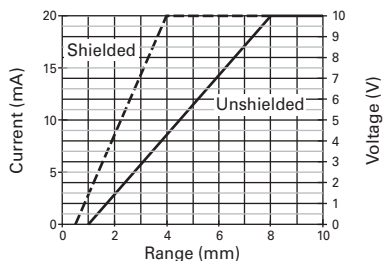

18 mm

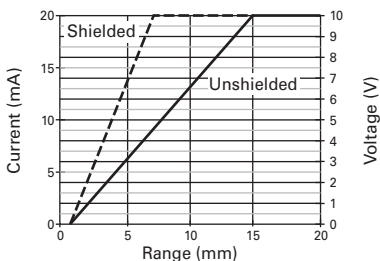

30 mm

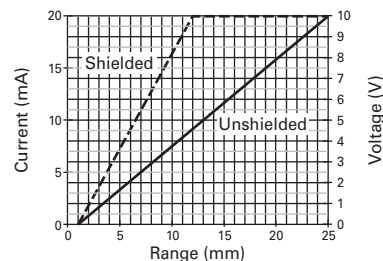

Measurement Resolution ①

12 mm

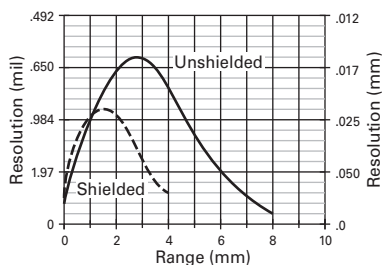

18 mm

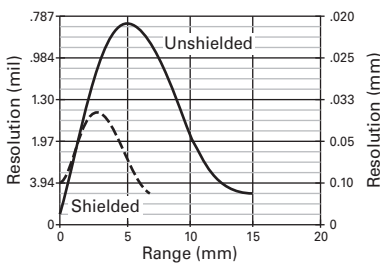

30 mm

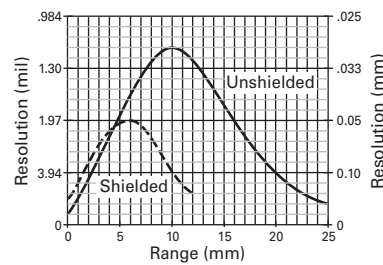

Output Resolution ②

12 mm

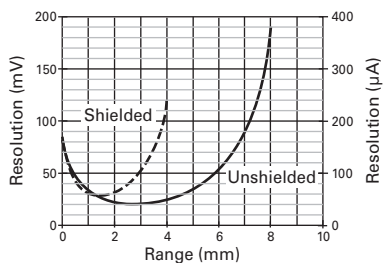

18 mm

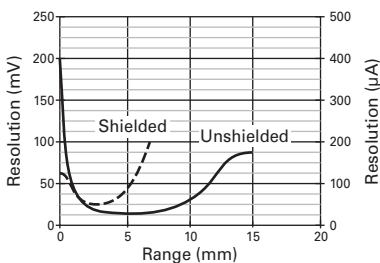

30 mm

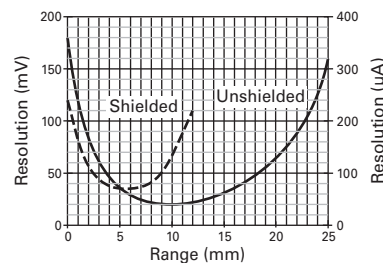

Notes

- ① Measurement resolution is the sensor's ability to detect a change in target position. The measurement resolution is the finest at the highest point in the curve.
- ② Output resolution is the change in output signal relative to target position. The minimum change in output resolution is defined by the lowest point in the curve.

3.6

Inductive Proximity Sensors

AccuProx Analog Sensors

Wiring Diagrams

Pin numbers are for reference, rely on pin location when wiring.

AccuProx Analog Sensors

3

Style	Output(s)	Micro-Connector Models	Cable and Pigtail Models
12 mm diameter models ending in -C1 ①	Current: 4–20 mA		
18 and 30 mm diameter models ending in -C1 ①			
Models ending in -CV	Current: 0–20 mA Voltage: 0–10 V		

Dimensions

Approximate Dimensions in Inches (mm)

Micro-Connector Models

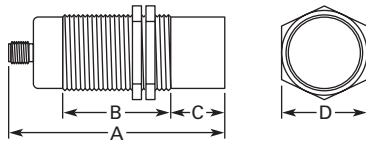

Size	Shielding	A	B	C	D
12 mm	Shielded	3.05 (77.5)	1.98 (50.3)	0.02 (0.50)	0.67 (17)
	Unshielded	3.05 (77.5)	1.64 (41.6)	0.36 (9)	0.67 (17)
18 mm	Shielded	2.73 (69.3)	2.00 (50.9)	0.02 (0.50)	0.94 (24)
	Unshielded	2.73 (69.3)	1.47 (37.4)	0.55 (14)	0.94 (24)
30 mm	Shielded	2.92 (74.1)	2.13 (54.1)	0.03 (0.75)	1.41 (36)
	Unshielded	2.92 (74.1)	1.41 (35.8)	0.75 (19)	1.41 (36)

Cable and Pigtail Models

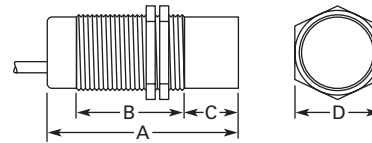

Size	Shielding	A	B	C	D
12 mm	Shielded	2.46 (62.4)	1.98 (50.3)	0.02 (0.5)	0.67 (17)
	Unshielded	2.46 (62.4)	1.64 (41.6)	0.36 (9)	0.67 (17)
18 mm	Shielded	2.54 (64.5)	2.00 (50.9)	0.02 (0.5)	0.94 (24)
	Unshielded	2.54 (64.5)	1.47 (37.4)	0.55 (14)	0.94 (24)
30 mm	Shielded	2.74 (69.6)	2.13 (54.1)	0.03 (0.75)	1.41 (36)
	Unshielded	2.74 (69.6)	1.41 (35.8)	0.75 (19)	1.41 (36)

Note

- ① For models ending in **-C1** (current output only models), pins 2 and 4 are intentionally connected. Do not connect outputs of **-C1** models to separate loads—this sensor should only be connected to a single-output load.

Ferrous Only Tubular Sensors



Contents

Description	Page
Ferrous Only Tubular Sensors	
Product Selection	
Ferrous Only Tubular Sensors	V8-T3-56
Compatible Connector Cables	V8-T3-56
Accessories	V8-T3-56
Technical Data and Specifications	V8-T3-57
Wiring Diagrams	V8-T3-57
Dimensions	V8-T3-57

Ferrous Only Tubular Sensors

Product Description

These unique Inductive Proximity Sensors have been specially made by Eaton's Electrical Sector to detect only a specific type of metal. Ferrous Only models will detect only ferrous metals such as steel, iron, nickel or cobalt.

A typical application for **Ferrous Only** sensors would be in workcell applications where cutting tools, tool pallets and fixtures must be detected for proper workpiece manipulation. The sensors detect ferrous objects while ignoring aluminum.

These sensors are available in a standard 18 mm diameter, and are epoxy filled for shock/vibration resistance and heat tolerance.

Features

- Ferrous Only sensors detect ferrous metals, such as steel or iron, while ignoring non-ferrous metals
- Selection of two-wire and three-wire, AC/DC and DC-only sensor models
- Wide operating temperature range: -13 to 158 °F (-25 to 70 °C)

DANGER

THIS SENSOR IS NOT A SAFETY DEVICE AND IS NOT INTENDED TO BE USED AS A SAFETY DEVICE. This sensor is designed only to detect and read certain data in an electronic manner and perform no use apart from that, specifically no safety-related use. This sensor product does not include self-checking redundant circuitry, and the failure of this sensor product could cause either an energized or de-energized output condition, which could result in death, serious bodily injury, or property damage.

For the most current information on this product, visit our Web site: www.eaton.com

For Customer Service in the U.S. call 1-877-ETN CARE (386-2273), in Canada call 1-800-268-3578.
For Application Assistance in the U.S. and Canada call 1-800-426-9184.

3.7

Inductive Proximity Sensors

Ferrous Only Tubular Sensors

Product Selection

Ferrous Only Tubular Sensors

3

Two-Wire Sensors





	Operating Voltage	Sensing Range (Sn)	Shielding	Connection Type	NO Output Catalog Number
	18 mm Diameter				
	20–250 Vac/dc 50/60 Hz	5.0 mm	Shielded	3-pin micro AC connector	E57FAL18A2SA Ⓢ
				3-pin mini-connector	E57FAL18A2B1 Ⓢ

Three-Wire Sensors

	Operating Voltage	Sensing Range (Sn)	Shielding	Connection Type	NO Output Catalog Number
	18 mm Diameter				
	10–30 Vdc	5.0 mm	Shielded (PNP)	4-pin micro DC connector	E57FAL18T111SD Ⓢ

Compatible Connector Cables

Standard Cables ①

	Current Rating at 600 V	Voltage Style	Number of Pins	Gauge	Length	Pin Configuration/Wire Colors (Face View Female Shown)	PVC Jacket Catalog Number	PUR Jacket Catalog Number
	Micro-Style, Straight Female							
	—	AC	3-pin, 3-wire	22 AWG	6.0 ft (2m)	 1-Green 2-Red/Black 3-Red/White	CSAS3F3CY2202	CSAS3F3RY2202
	Mini-Style, Straight Female							
	13 A	—	3-pin	16 AWG	6.0 ft (2m)	 1-Brown 2-No Wire 3-Blue 4-Black	CSDS4A3CY2202	CSDS4A3RY2202
						 1-Green 2-Black 3-White	CSMS3F3CY1602	

Accessories

Ferrous Only Tubular Sensors

Description	Reference
Mounting brackets	See Tab 8, section 8.2
Replacement mounting nuts and other accessories	See Tab 8, section 8.3
Connector cables	See Tab 10, section 10.1

Notes

ⓈⓈ See listing of compatible connector cables above.

① For a full selection of connector cables, see **Tab 10, section 10.1**.

Technical Data and Specifications

Ferrous Only Tubular Sensors

Description	Two-Wire AC/DC Sensors	Three-Wire DC Sensors
Operating voltage	20–250 Vac/dc	10–30 Vdc
Maximum load current	100 mA	100 mA
Switching frequency	15 Hz	1000 Hz
Leakage current	2.5 mA maximum	<0.01 mA
Voltage drop	10 V maximum	1.5 V maximum
Holding current	5 mA minimum	—
Burden current	—	17 mA
Protection	Transient, power on false pulse suppression	Short-circuit protection
Switching hysteresis	<15% rated sensing distance	<15% rated sensing distance
Repeat accuracy	<1% sensing distance	<1% sensing distance
Time delay before availability	<10 ms	<10 ms
Output indicator LED	Lights when output is ON	Lights when output is ON
Operating temperature	–13 to 131 °F (–25 to 55 °C)	–13 to 131 °F (–25 to 55 °C)
Enclosure ratings	NEMA 4, 4X, 6, 6P, 12 and 13 (IP67)	NEMA 4, 4X, 6, 6P, 12 and 13 (IP67)
Shock	30 g sine wave, 11 ms per IEC68-2-76	30 g sine wave, 11 ms per IEC68-2-76
Vibration	10 to 55 Hz, 1 mm amplitude in all three planes	10 to 55 Hz, 1 mm amplitude in all three planes
Housing material	Stainless steel	Stainless steel

Wiring Diagrams

Pin numbers are for reference, rely on pin location when wiring.

Ferrous Only Tubular Sensors

Operating Voltage	Output	Connector Models (Face View Male Shown)	
		Micro	Mini
Two-Wire Sensors			
20–250 Vac/dc 50/60 Hz	NO		
Three-Wire Sensors			
10–30 Vdc	NO (PNP)	—	

Dimensions

Approximate Dimensions in Inches (mm)

Ferrous Only Tubular Sensors

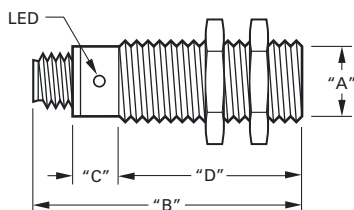

Connector Models

Catalog Number	A	B	C	D
Two-Wire Models				
E57FAL18A2SA	M18 x 1	3.11 (79)	1.38 (35)	1.73 (44)
E57FAL18A2B1	M18 x 1	3.90 (99)	1.34 (34)	2.56 (65)
Three-Wire Models				
E57FAL18T111SD	M18 x 1	3.11 (79)	1.14 (29)	1.97 (50)

Metal Face Sensors

3



Metal Face Sensors

Product Description

Metal Face Inductive Proximity Sensors by Eaton's Electrical Sector incorporate tough stainless steel sensing faces in place of the plastic faces found in standard sensors. This provides a higher level of protection for more reliable operation and longer life in harsh environments.

The sensors stand up to abrasion and impact caused by flying metal chips, grit, and misaligned or vibrating targets. In addition, the stainless steel body resists corrosion and chemical attack.

Common sensor diameters, voltage styles and wiring connections make it easy to retrofit your existing, damaged sensors. Solve the problem of damaged sensors permanently with Eaton's Metal Face Sensors.

Features

- Two-wire AC/DC models and three-wire DC models are compatible with your existing wiring
- Common 12 mm, 18 mm and 30 mm housing diameters allow easy changeout of existing damaged sensors
- The 20 mil stainless steel sensing face is thicker than competing units for a higher level of protection
- The stainless steel body is damage and corrosion resistant
- Wide operating temperature range: -13 to 158 °F (-25 to 70 °C)

Contents

Description

	<i>Page</i>
Metal Face Sensors	
Product Selection	
Metal Face Sensors	V8-T3-59
Compatible Connector Cables	V8-T3-56
Accessories	V8-T3-60
Technical Data and Specifications	V8-T3-60
Wiring Diagrams	V8-T3-61
Dimensions	V8-T3-61

⚠ DANGER

THIS SENSOR IS NOT A SAFETY DEVICE AND IS NOT INTENDED TO BE USED AS A SAFETY DEVICE. This sensor is designed only to detect and read certain data in an electronic manner and perform no use apart from that, specifically no safety-related use. This sensor product does not include self-checking redundant circuitry, and the failure of this sensor product could cause either an energized or de-energized output condition, which could result in death, serious bodily injury, or property damage.



For the most current information on this product, visit our Web site: www.eaton.com

For Customer Service in the U.S. call 1-877-ETN CARE (386-2273), in Canada call 1-800-268-3578.
For Application Assistance in the U.S. and Canada call 1-800-426-9184.



Product Selection

Metal Face Sensors

Two-Wire Sensors



	Operating Voltage	Sensing Range (Sn)	Shielding	Connection Type	NO Output Catalog Number
12 mm	12 mm Diameter				
	20–250 Vac/dc 50/60 Hz	2 mm	Shielded	3-pin micro AC connector	E57FAL12A2SA-M ⓘ
30 mm	30 mm Diameter				
	20–250 Vac/dc 50/60 Hz	10 mm	Shielded	3-pin micro AC connector	E57FAL30A2SA-M ⓘ

Three-Wire Sensors

	Operating Voltage	Sensing Range (Sn)	Shielding	Connection Type	NO Output Catalog Number
12 mm	12 mm Diameter				
	10–30 Vdc	2 mm	Shielded (PNP)	4-pin micro DC connector	E57FAL12T111SD-M ⓘ
18 mm	18 mm Diameter				
	10–30 Vdc	5 mm	Shielded (PNP)	4-pin micro DC connector	E57FAL18T111SD-M ⓘ

Compatible Connector Cables

Standard Cables ⓘ

	Voltage Style	Number of Pins	Gauge	Length	Pin Configuration/Wire Colors (Face View Female Shown)	PVC Jacket Catalog Number	PUR Jacket Catalog Number
Micro-Style Straight Female 	Micro-Style, Straight Female						
	AC	3-pin, 3-wire	22 AWG	6.0 ft (2m)	 1-Green 2-Red/Black 3-Red/White	CSAS3F3CY2202	CSAS3F3RY2202
	DC	4-pin, 4-wire	22 AWG	6.0 ft (2m)	 1-Brown 2-White 3-Blue 4-Black	CSDS4A4CY2202	CSDS4A4RY2202

Notes

- ⓘ See listing of compatible connector cables above.
- ⓘ For a full selection of connector cables, see **Tab 10, section 10.1**.

Accessories

Metal Face Sensors

Description	Reference
Mounting brackets	See Tab 8, section 8.2
Replacement mounting nuts and other accessories	See Tab 8, section 8.3
Connector cables	See Tab 10, section 10.1

Technical Data and Specifications

Metal Face Sensors

Description	Two-Wire AC/DC Sensors	Three-Wire DC Only Sensors
Operating voltage	20–250 Vac/dc	10–30 Vdc
Maximum load current	100 mA	100 mA
Switching frequency		
12 mm	15 Hz	2000 Hz
18 mm	—	1000 Hz
30 mm	—	300 Hz
Leakage current	2.5 mA maximum	600 µA maximum
Voltage drop	10 V maximum	1.5 V maximum
Holding current	5 mA minimum	—
Burden current	—	17 mA
Protection	Transient, power on false pulse suppression	Short-circuit protection
Switching hysteresis	<15% rated sensing distance	<15% rated sensing distance
Repeat accuracy	<1% sensing distance	<1% sensing distance
Time delay before availability	<200 ms	<200 ms
Output indicator LED	Lights when output is ON	Lights when output is ON
Operating temperature	–13 to 131 °F (–25 to 55 °C)	–13 to 131 °F (–25 to 55 °C)
Enclosure ratings	NEMA 4, 4X, 6, 6P, 12 and 13 (IP67)	NEMA 4, 4X, 6, 6P, 12 and 13 (IP67)
Shock	30 g sine wave, 11 ms per IEC68-2-76	30 g sine wave, 11 ms per IEC68-2-76
Vibration	10 to 55 Hz, 1 mm amplitude in all three planes	10 to 55 Hz, 1 mm amplitude in all three planes
Housing material	303 stainless steel	303 stainless steel
Face thickness	20 mils	20 mils

Wiring Diagrams

Pin numbers are for reference, rely on pin location when wiring.

Metal Face Sensors

Operating Voltage	Output	Micro-Connector Models (Face View Male Shown)
Two-Wire Sensors		
20–250 Vac/dc 50/60 Hz	NO	
Three-Wire Sensors		
10–30 Vdc	NO (NPN)	
	NO (PNP)	

Dimensions

Approximate Dimensions in Inches (mm)

Metal Face Sensors

Connector Models

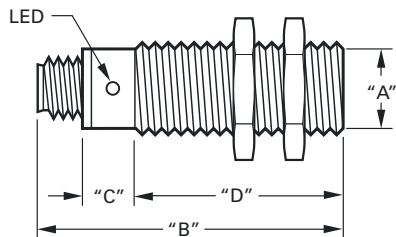

Catalog Number	A	B	C	D
Two-Wire Models				
E57FAL12A2SA-M	M x 12	2.67 (68)	1.10 (28)	1.58 (40)
E57FAL30A2SA-M	M x 30	3.70 (94)	1.34 (34)	2.36 (60)
Three-Wire Models				
E57FAL12T111SD-M	M x 12	2.67 (68)	1.02 (26)	1.65 (42)
E57FAL18T110SD-M	M x 18	3.11 (79)	1.14 (29)	1.97 (50)
E57FAL18T111SD-M	M x 18	3.11 (79)	1.14 (29)	1.97 (50)

High Current Output Sensors

3



Contents

<i>Description</i>	<i>Page</i>
High Current Output Sensors	
Product Selection	V8-T3-63
Accessories	V8-T3-63
Technical Data and Specifications	V8-T3-64
Wiring Diagrams	V8-T3-64
Dimensions	V8-T3-64

High Current Output Sensors

Product Description

Now there is an alternative to limit switches for position sensing on industrial vehicles. High Current Output Sensors feature a continuous output current rating from 2 to 8 A. These sensors from Eaton's Electrical Sector are ideally suited to handle high current loads found on such industrial vehicles as aerial lift trucks, fork lifts, refuse trucks, cement mixers, dump trucks, hook and ladder trucks, front end loaders, farm equipment and hundreds of other vehicles that are constantly subjected to mechanical (shock, vibration, collisions) and environmental (dirt, grease, ice, rain) abuse that create havoc with mechanical devices.

Features

- Solid-state output can handle up to 8 A continuous
- Ideal for vehicle use to replace mechanical limit switches, typically required to handle high currents
- Wide voltage and temperature range covers most vehicle power supplies and operating environments
- Normally Open and Normally Closed isolated outputs
- SJO cable is available in custom lengths
- Dual colored 360° LED indicating light, green as power ON and red as output

⚠ DANGER

THIS SENSOR IS NOT A SAFETY DEVICE AND IS NOT INTENDED TO BE USED AS A SAFETY DEVICE. This sensor is designed only to detect and read certain data in an electronic manner and perform no use apart from that, specifically no safety-related use. This sensor product does not include self-checking redundant circuitry, and the failure of this sensor product could cause either an energized or de-energized output condition, which could result in death, serious bodily injury, or property damage.

For the most current information on this product, visit our Web site: www.eaton.com

For Customer Service in the U.S. call 1-877-ETN CARE (386-2273), in Canada call 1-800-268-3578. For Application Assistance in the U.S. and Canada call 1-800-426-9184.

Product Selection

High Current Output Sensors

30 mm



Four-Wire Sensors

Operating Voltage	Sensing Range	Shielding	Output Type	Output Rating		Connection Type ^①	Catalog Number
				Continuous	<100 ms Pulse		
30 mm Diameter							
10–55 Vdc	10 mm	Shielded	NO and NC (PNP)	3.5 A	20 A	2-meter cable	E57-30JS10-H

30 mm



Six-Wire Sensors ^②

Operating Voltage	Sensing Range	Shielding	Output Type	Output Rating		Connection Type ^①	Catalog Number
				Continuous	<100 ms Pulse		
30 mm Diameter							
10–30 Vdc	10 mm	Shielded	NO and NO, or NC and NC (NPN or PNP)	8 A	50 A	2-meter cable	E57-30HS10-K

Accessories

High Current Output Sensors

Description	Reference
Mounting brackets	See Tab 8, section 8.2
Replacement mounting nuts and other accessories	See Tab 8, section 8.3

Notes

- ① For additional cable length other than 2-meter, add desired length in meters to listed catalog number. Example: For an E57-30JS10-H with a 5-meter cable, order E57-30JS10-H5.
- ② 50 Amp surge, 12 Amp at 50% duty cycle and 8 Amp continuous.

3.9

Inductive Proximity Sensors

High Current Output Sensors

3

Technical Data and Specifications

High Current Output Sensors

Description	Four-Wire Sensors	Six-Wire Sensors
Operating voltage	10 to 55 Vdc	10 to 30 Vdc
Switching rate	250 Hz	100 Hz
Off-state current	100 A μ maximum	100 A μ maximum
Voltage drop	1.2 V	2.0 V
Burden current	10 mA at 55 volts	30 mA at 30 volts
Time delay before availability	<100 ms	<100 ms
Output indicator LED	360° visibility	360° visibility
Output type	Solid-state	Solid-state, isolated
Protection	Transient and power on false pulse	Transient and power on false pulse
Enclosure ratings	NEMA 4, 4X, 6, 6P, 12 and 13 (IEC IP67)	NEMA 4, 4X, 6, 6P, 12 and 13 (IEC IP67)
Ambient temperature range	-40 to 158 °F (-40 to 70 °C)	-40 to 158 °F (-40 to 70 °C)
Barrel material	303 stainless steel	303 stainless steel
Cable	2m standard SJO water resistive (18 AWG)	2m standard SJO water resistive (18 AWG)
Shock	30 g sine wave, 11 ms	30 g sine wave, 11 ms
Vibration	10 to 55 Hz, 2 mm amplitude in all 3 planes	10 to 55 Hz, 2 mm amplitude in all 3 planes

Wiring Diagrams

Four-Wire—PNP

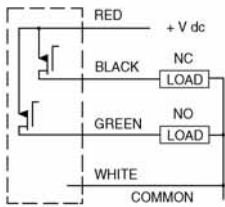

Six-Wire—NO/NO Output Configuration

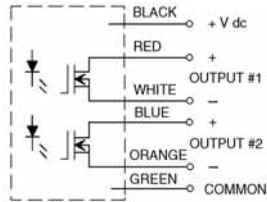

Six-Wire—NC/NC Output Configuration

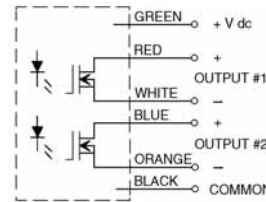

Dimensions

Approximate Dimensions in Inches (mm)

High Current Output Sensors

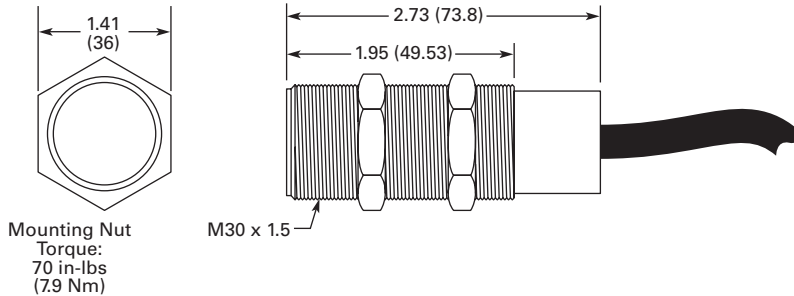

Small Diameter (4, 5, 6.5, 8 mm) Sensors



Contents

Description	Page
Small Diameter (4, 5, 6.5, 8 mm) Sensors	
Product Selection	
Small Diameter (4, 5, 6.5, 8 mm) Sensors	V8-T3-66
Compatible Connector Cables	V8-T3-68
Accessories	V8-T3-56
Technical Data and Specifications	V8-T3-69
Wiring Diagrams	V8-T3-69
Dimensions	V8-T3-70

Small Diameter (4, 5, 6.5, 8 mm) Sensors

Product Description

These unique Inductive Proximity Sensors by Eaton's Electrical Sector are designed to be used in extremely small spaces. A wide variety of models are available with housing diameters from 8 mm all the way down to 4 mm, allowing you to choose the one that best fits your application. The sensors are three-wire devices that operate from 10 to 30 Vdc. Both shielded and unshielded versions are available.

Application Description

Typical Applications

- Automation equipment
- Robotics
- Machine tool
- Counting
- Sorting

Features

- Small 4, 5, 6.5 and 8 mm diameters for use in applications with limited space for mounting sensors
- Stainless steel housings
- All models include an LED indicator to show output status
- Short circuit and reverse polarity protection
- Rated NEMA 4, 4X, 6, 6P, 12 and 13 (IP67) for high resistance to environmental factors

Standards and Certifications

- cCSAus (8 mm only)
- CE



! DANGER

THIS SENSOR IS NOT A SAFETY DEVICE AND IS NOT INTENDED TO BE USED AS A SAFETY DEVICE. This sensor is designed only to detect and read certain data in an electronic manner and perform no use apart from that, specifically no safety-related use. This sensor product does not include self-checking redundant circuitry, and the failure of this sensor product could cause either an energized or de-energized output condition, which could result in death, serious bodily injury, or property damage.

For the most current information on this product, visit our Web site: www.eaton.com

For Customer Service in the U.S. call 1-877-ETN CARE (386-2273), in Canada call 1-800-268-3578. For Application Assistance in the U.S. and Canada call 1-800-426-9184.

3.10

Inductive Proximity Sensors





Small Diameter (4, 5, 6.5, 8 mm) Sensors

Product Selection

Small Diameter (4, 5, 6.5, 8 mm) Sensors

3

Three-Wire Sensors

	Operating Voltage	Sensing Range (Sn)	Shielding	Connection Type	NO Output Catalog Number	NC Output Catalog Number
4 mm 	4 mm Diameter (Unthreaded)					
	10–30 Vdc	0.8 mm	Shielded (NPN)	2-meter cable	E57EAL4T110SP	—
				3-pin nano-connector	E57EAL4T110SN ☹	—
			Shielded (PNP)	2-meter cable	E57EAL4T111SP	—
				3-pin nano-connector	E57EAL4T111SN ☹	—
	5 mm Diameter					
5 mm 	10–30 Vdc	0.8 mm	Shielded (NPN)	2-meter cable	E57EAL5T110SP	—
				3-pin nano-connector	E57EAL5T110SN ☹	—
			Shielded (PNP)	2-meter cable	E57EAL5T111SP	—
				3-pin nano-connector	E57EAL5T111SN ☹	—
6.5 mm Diameter (Unthreaded)						
6.5 mm 	10–30 Vdc	1 mm	Shielded (NPN)	2-meter cable	E57EAL6T110SP	—
				3-pin nano-connector	E57EAL6T110SN ☹	—
				4-pin micro DC connector	E57EAL6T110SD ☹	—
			Shielded (PNP)	2-meter cable	E57EAL6T111SP	—
				3-pin nano-connector	E57EAL6T111SN ☹	—
				4-pin micro DC connector	E57EAL6T111SD ☹	—
	2 mm	Unshielded (NPN)	2-meter cable	E57EAL6T110EP	—	
			3-pin nano-connector	E57EAL6T110EN ☹	—	
			2-meter cable	E57EAL6T111EP	—	
			3-pin nano-connector	E57EAL6T111EN ☹	—	
8 mm Diameter Short Body						
8 mm Short Body 	10–30 Vdc	1 mm	Shielded (NPN)	2-meter cable	E57EAL8T110SP	E57EAL8T110SP
				3-pin nano-connector	E57EAL8T110SN ☹	E57EAL8T110SN ☹
				4-pin micro DC connector	E57EAL8T110SD ☹	E57EAL8T110SD ☹
			Shielded (PNP)	2-meter cable	E57EAL8T111SP	E57EAL8T111SP
				3-pin nano-connector	E57EAL8T111SN ☹	E57EAL8T111SN ☹
				4-pin micro DC connector	E57EAL8T111SD ☹	E57EAL8T111SD ☹
		2 mm	Unshielded (NPN)	2-meter cable	E57EAL8T110EP	E57EAL8T110EP
				3-pin nano-connector	E57EAL8T110EN ☹	E57EAL8T110EN ☹
				4-pin micro DC connector	E57EAL8T110ED ☹	E57EAL8T110ED ☹
			Unshielded (PNP)	2-meter cable	E57EAL8T111EP	E57EAL8T111EP
				3-pin nano-connector	E57EAL8T111EN ☹	E57EAL8T111EN ☹
				4-pin micro DC connector	E57EAL8T111ED ☹	E57EAL8T111ED ☹

Note

☹☹ See listing of compatible connector cables on **Page V8-T3-68**.

Three-Wire Sensors, continued

8 mm Standard Length



Operating Voltage	Sensing Range	Shielding	Output Type	Connection Type	NO Output Catalog Number	NC Output Catalog Number
8 mm Diameter Standard Length						
10–30 Vdc	1 mm	Shielded	NPN	2-meter cable	E57-08GS01-C	E57-08GS01-C1
				3-pin nano-connector	E57-08GS01-CNB ☺	E57-08GS01-C1NB ☺
				4-pin micro DC connector	E57-08GS01-CDB ☺	E57-08GS01-C1DB ☺
			PNP	2-meter cable	E57-08GS01-G	E57-08GS01-G1
				3-pin nano-connector	E57-08GS01-GNB ☺	E57-08GS01-G1NB ☺
				4-pin micro DC connector	E57-08GS01-GDB ☺	E57-08GS01-G1DB ☺
	3 mm (extended range)	NPN	Shielded	2-meter cable	E57-08GE03-C	E57-08GE03-C1
				3-pin nano-connector	E57-08GE03-CNB ☺	E57-08GE03-C1NB ☺
				4-pin micro DC connector	E57-08GE03-CDB ☺	E57-08GE03-C1DB ☺
		PNP	2-meter cable	E57-08GE03-G	E57-08GE03-G1	
			3-pin nano-connector	E57-08GE03-GNB ☺	E57-08GE03-G1NB ☺	
			4-pin micro DC connector	E57-08GE03-GDB ☺	E57-08GE03-G1DB ☺	
2 mm	Unshielded	NPN	2-meter cable	E57-08GU02-C	E57-08GU02-C1	
			3-pin nano-connector	E57-08GU02-CNB ☺	E57-08GU02-C1NB ☺	
			4-pin micro DC connector	E57-08GU02-CDB ☺	E57-08GU02-C1DB ☺	
		PNP	2-meter cable	E57-08GU02-G	E57-08GU02-G1	
			3-pin nano-connector	E57-08GU02-GNB ☺	E57-08GU02-G1NB ☺	
			4-pin micro DC connector	E57-08GU02-GDB ☺	E57-08GU02-G1DB ☺	
	6 mm (extended range)	NPN	Unshielded	2-meter cable	E57-08GE06-C	E57-08GE06-C1
				4-pin micro DC connector	E57-08GE06-CDB ☺	E57-08GE06-C1DB ☺
				PNP	2-meter cable	E57-08GE06-G
		PNP	2-meter cable	E57-08GE06-G	E57-08GE06-G1	
			4-pin micro DC connector	E57-08GE06-GDB ☺	E57-08GE06-G1DB ☺	
			4-pin micro DC connector	E57-08GE06-GDB ☺	E57-08GE06-G1DB ☺	

Note

☺☺ See listing of compatible connector cables on **Page V8-T3-31**.

3.10





Inductive Proximity Sensors

Small Diameter (4, 5, 6.5, 8 mm) Sensors

Compatible Connector Cables

3

Standard Cables^①

	Voltage Style	Number of Pins	Gauge	Length	Pin Configuration/Wire Colors (Face View Female Shown)	PVC Jacket Catalog Number	PUR Jacket Catalog Number
Micro-Style Straight Female 	Micro-Style, Straight Female						
	DC	4-pin, 3-wire	22 AWG	6.0 ft (2m)		CSDS4A3CY2202	CSDS4A3RY2202
		4-pin, 4-wire	22 AWG	6.0 ft (2m)		CSDS4A4CY2202	CSDS4A4RY2202
Nano-Style Straight Female 	Nano-Style, Straight Female						
—	3-pin	24 AWG	6.0 ft (2m)		CSNS3A3CY2402	CSNS3A3RY2402	

Accessories

Small Diameter Sensors

Description	Reference
Mounting brackets	See Tab 8, section 8.2
Replacement mounting nuts and other accessories	See Tab 8, section 8.3
Connector cables	See Tab 10, section 10.1

Note

^① For a full selection of connector cables, see **Tab 10, section 10.1**.

Technical Data and Specifications

Small Diameter Sensors

Description	Three-Wire DC Only Sensors
Operating voltage	10–30 Vdc
Maximum load current	200 mA
Switching frequency	2 kHz
Leakage current	0.01 mA maximum
Voltage drop	1.5 V maximum
Burden current	10 mA maximum
Protection	Transient, power on false pulse suppression, auto reset short circuit
Switching hysteresis	<15% rated sensing distance
Repeat accuracy	<1% sensing distance
Time delay before availability	<50 ms
Output indicator LED	Lights when output is ON
Operating temperature	–13 to 158 °F (–25 to 70 °C)
Enclosure ratings	NEMA 4, 4X, 6, 6P, 12 and 13 (IP67)
Housing material	Stainless steel
Cable	PVC high flex, oil/water resistant, 22 AWG

Wiring Diagrams

Pin numbers are for reference, rely on pin location when wiring.

Small Diameter Sensors

Operating Voltage	Output	Cable Models	Connector Models (Face View Male Shown) Micro	Nano
Three-Wire Sensors				
10–30 Vdc	NO (NPN)			
	NO (PNP)			
	NC (NPN)			
	NC (PNP)			

3.10

Inductive Proximity Sensors

Small Diameter (4, 5, 6.5, 8 mm) Sensors

3

Dimensions

Approximate Dimensions in Inches (mm)

Cable Models

Unthreaded Barrel

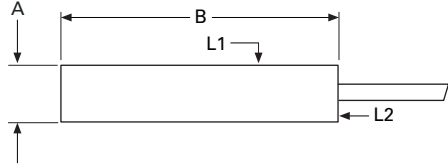

Threaded Barrel

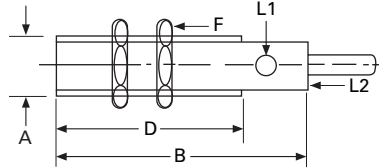

Size A ①	Barrel Type	Length B	D	Thread Size	Nut Width F	Connector Diameter G	LED Location
Cable Models							
4 mm (S, Std)	Unthreaded	1.0 (25)	—	—	—	—	L1
5 mm (S, Std)	Threaded	1.0 (25)	0.8 (21)	M5 x 0.5	SW8	—	L1
6.5 mm (S/U, Std)	Unthreaded	1.8 (45)	—	—	—	—	L2
8 mm Short Body (S/U, Std)	Threaded	1.2 (30)	1.2 (30)	M8 x 1	SW13	—	L2
Standard Length							
8 mm (S, Std)	Threaded	1.77 (45)	1.77 (45)	M8 x 1	SW13	—	L2
8 mm (S, Ext)	Threaded	1.81 (46)	1.57 (40)	M8 x 1	SW13	—	L2
8 mm (U, Std)	Threaded	1.77 (45)	1.61 (41)	M8 x 1	SW13	—	L2
8 mm (U, Ext)	Threaded	1.77 (45)	1.61 (41)	M8 x 1	SW13	—	L2

Connector Models

Unthreaded Barrel

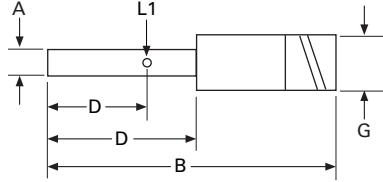

Threaded Barrel

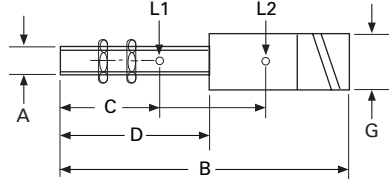

Standard Length 8 mm

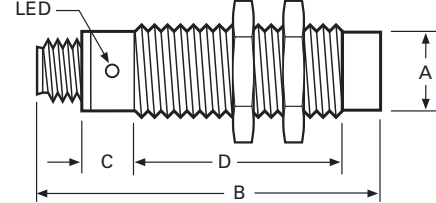

Size A ①	Barrel Type	Length B	C	D	Thread Size	Nut Width F	Connector Diameter G	LED Location
Nano-Connector Models								
4 mm (S, Std)	Unthreaded	1.6 (40)	0.7 (18)	0.8 (21)	—	—	0.31 (8)	L1
5 mm (S, Std)	Threaded	1.6 (40)	0.7 (18)	0.8 (21)	M5 x 0.5	SW8	0.31 (8)	L1
6.5 mm (S/U, Std)	Unthreaded	2.4 (60)	1.5 (39)	2.0 (50)	—	—	0.31 (8)	L1
8 mm Short Body (S/U, Std)	Threaded	1.8 (45)	1.0 (25)	1.4 (36)	M8 x 1	SW13	0.31 (8)	L1
Standard Length								
8 mm (S, Std)	Threaded	2.36 (60)	0.79 (20)	1.57 (40)	M8 x 1	SW13	0.31 (8)	L2
8 mm (S, Ext)	Threaded	2.40 (61)	0.75 (19)	1.65 (42)	M8 x 1	SW13	0.31 (8)	L2
8 mm (U, Std)	Threaded	2.36 (60)	0.79 (20)	1.42 (36)	M8 x 1	SW13	0.31 (8)	L2
Micro-Connector Models								
6.5 mm (S/U, Std)	Unthreaded	2.9 (70)	1.4 (36)	1.5 (39)	—	—	0.47 (12)	L1
8 mm Short Body (S/U, Std)	Threaded	2.0 (50)	1.6 (40)	1.0 (25)	M8 x 1	SW13	0.47 (12)	L2
Standard Length								
8 mm (S, Std)	Threaded	2.76 (70)	0.83 (21)	1.93 (49)	M8 x 1	SW13	0.47 (12)	L2
8 mm (S, Ext)	Threaded	2.80 (71)	1.02 (26)	1.42 (36)	M8 x 1	SW13	0.47 (12)	L2
8 mm (U, Std)	Threaded	2.76 (70)	0.83 (21)	1.77 (45)	M8 x 1	SW13	0.47 (12)	L2
8 mm (U, Ext)	Threaded	2.76 (70)	1.22 (31)	1.38 (35)	M8 x 1	SW13	0.47 (12)	L2

Note

① U = Unshielded (4 mm cap), S = Shielded; Std = Standard Range, Ext = Extended Range.

E56 Pancake Sensors



Contents

Description	Page
E56 Pancake Sensors	
Product Selection	
E56 Pancake Sensors	V8-T3-72
Compatible Connector Cables	V8-T3-73
Technical Data and Specifications	V8-T3-74
Wiring Diagrams	V8-T3-75
Dimensions	V8-T3-75

E56 Pancake Sensors

Product Description

The E56 Pancake Sensor from Eaton's Electrical Sector is a high performance inductive proximity sensor. The E56 Pancake provides greater sensing ranges than other inductive sensor package types.

The E56 Pancake family provides convenience and ease of wiring with auto-configurable, complementary outputs. (Auto-configurable outputs automatically detect an NPN or PNP output configuration and switch the sensor accordingly, without user intervention.) Power and output LEDs make troubleshooting much easier than conventional proximity sensors, which usually only feature output LEDs. These convenience features, combined with the performance of the E56 Pancake, make it an excellent inductive sensing solution for applications requiring an extremely rugged, long-range sensing solution.

Application Description

Typical Applications

- Heavy-duty trucks, cranes and machinery
- Steel mills
- Pipe and rod manufacturing
- Automotive manufacturing
- Amusement parks

Features

- Longest inductive sensing ranges available (up to 100 mm)
- Three sizes to meet your application needs, with maximum ranges of 50, 70 or 100 mm
- Complementary outputs (1NO/1NC) on four-wire DC models
- Auto-configure output technology on four-wire DC models, which automatically detect how the sensor has been wired (NPN or PNP) and switch the sensor without user intervention
- Small diameter, two-wire AC models feature a selector switch inside the housing, enabling output contacts to be used as either NO or NC
- Robust design featuring vibration and impact-absorbing potting compound
- Ideal for extreme temperatures or high pressure washdown environments

Standards and Certifications

- CE



DANGER

THIS SENSOR IS NOT A SAFETY DEVICE AND IS NOT INTENDED TO BE USED AS A SAFETY DEVICE. This sensor is designed only to detect and read certain data in an electronic manner and perform no use apart from that, specifically no safety-related use. This sensor product does not include self-checking redundant circuitry, and the failure of this sensor product could cause either an energized or de-energized output condition, which could result in death, serious bodily injury, or property damage.

For the most current information on this product, visit our Web site: www.eaton.com

For Customer Service in the U.S. call 1-877-ETN CARE (386-2273), in Canada call 1-800-268-3578.
For Application Assistance in the U.S. and Canada call 1-800-426-9184.

3.11

Inductive Proximity Sensors

E56 Pancake Sensors

Product Selection

E56 Pancake Sensors

3

Pancake Style



Two-Wire Sensors

Voltage Type	Output Configuration	Output Contacts	Shielding	Sensing Range	Connector Style	Catalog Number
Pancake Style						
20–250 Vac 45/65 Hz	—	NO or NC	Unshielded	1.57 in (40 mm)	Screw terminals	E56CDL40A2
					3-pin mini-connector	E56CDL40A2B1 ☺
90–260 Vac 45/65 Hz	—	NO or NC	Unshielded	2 in (50 mm)	Screw terminals	E56CDL50A2E
					3-pin mini-connector	E56CDL50A2EB1 ☺
		NO	Unshielded	2.75 in (70 mm) ①	3-pin mini-connector	E56CAL70B1S1 ☺
					3-pin mini-connector	E56CAL100B1S1 ☺

DC Four-Wire Sensors

Small Diameter



Voltage Type	Output Configuration	Output Contacts	Shielding	Sensing Range	Connector Style	Catalog Number
Small Diameter (79 x 79 x 39 mm)						
10–42 Vdc	NPN/PNP autoconfigure ②	1 NO and 1 NC	Shielded	1.57 in (40 mm)	DC screw	E56ADL40SA
					DC 4-pin mini	E56ADL40SAE01 ☺
			DC 4-pin micro	E56ADL40SAD01 ☺		
			Unshielded	1.57 in (40 mm)	DC screw	E56ADL40UA
		DC 4-pin mini	E56ADL40UAE01 ☺			
		DC 4-pin micro	E56ADL40UAD01 ☺			
		Unshielded	2 in (50 mm)	DC screw	E56ADL50UA	
				DC 4-pin mini	E56ADL50UAE01 ☺	
DC 4-pin micro	E56ADL50UAD01 ☺					

Medium Diameter



Medium Diameter (110 x 110 x 41 mm)						
10–42 Vdc	NPN/PNP autoconfigure ②	1 NO and 1 NC	Unshielded	2.75 in (70 mm)	DC 4-pin mini	E56BDL70UAE01 ☺
					DC 4-pin micro	E56BDL70UAD01 ☺

Large Diameter



Large Diameter (172 x 172 x 68 mm)						
10–42 Vdc	NPN/PNP autoconfigure ②	1 NO and 1 NC	Unshielded	3.94 in (100 mm)	DC 4-pin mini	E56CDL100UAE01 ☺
					DC 4-pin micro	E56CDL100UAD01 ☺

Notes







☺ ☺ See listing of compatible connector cables on **Page V8-T3-73**.

① Includes potentiometer for adjustment of sensing range.

② Autoconfigure technology allows the sensor to automatically adapt to NPN or PNP without user intervention.

Compatible Connector Cables

Standard Cables ^①

	Current Rating at 600 V	Voltage Style	Number of Pins	Gauge	Length	Pin Configuration/Wire Colors (Face View Female Shown)	PVC Jacket Catalog Number	PUR Jacket Catalog Number
Micro-Style Straight Female 	Micro-Style, Straight Female							
	—	AC	3-pin, 3-wire	22 AWG	6.0 ft (2m)	 1-Green 2-Red/Black 3-Red/White	CSAS3F3CY2202	CSAS3F3RY2202
					16.4 ft (5m)		CSAS3F3CY2205	CSAS3F3RY2205
					32.8 ft (10m)		CSAS3F3CY2210	CSAS3F3RY2210
	—	DC	4-pin, 4-wire	22 AWG	6.0 ft (2m)	 1-Brown 2-White 3-Blue 4-Black	CSDS4A4CY2202	CSDS4A4RY2202
					16.4 ft (5m)		CSDS4A4CY2205	CSDS4A4RY2205
32.8 ft (10m)					CSDS4A4CY2210		CSDS4A4RY2210	
Mini-Style Straight Female 	Mini-Style, Straight Female							
	13 A	—	3-pin, 3-wire	16 AWG	6.0 ft (2m)	 1-Green 2-Black 3-White	CSMS3F3CY1602	—
					13.1 ft (4m)		CSMS3F3CY1604	—
	10 A	AC/DC	4-pin, 4-wire	16 AWG	6.0 ft (2m)	 1-Black 2-Blue 3-Brown 4-White	CSMS4A4CY1602	—
					13.1 ft (4m)		CSMS4A4CY1604	—
					19.7 ft (6m)		CSMS4A4CY1606	—

Note

^① For a full selection of connector cables, see **Tab 10, section 10.1**.

Technical Data and Specifications

Two-Wire

3

Description	AC Two-Wire		
	Small Diameter	Medium Diameter	Large Diameter
Operating voltage	20–250 Vac	20–250 Vac	20–250 Vac
Load current (maximum)	400 mA	400 mA	400 mA
Off-state leakage	At or above 32 °F (0 °C): <1.7 mA; below 32 °F (0 °C): 2.0 mA	At or above 32 °F (0 °C): <1.7 mA; below 32 °F (0 °C): 2.0 mA	At or above 32 °F (0 °C): <1.7 mA; below 32 °F (0 °C): 2.0 mA
Voltage drop	<10 V (5 V nominal)	<10 V (5 V nominal)	<10 V (5 V nominal)
Outputs	NO or NC (switch selectable)	NO or NC by model	NO or NC by model
Sensing range (maximum)	50 mm	70 mm	100 mm
Range adjustment	Not adjustable	Potentiometer adjustable down to 50% of rated maximum range	Potentiometer adjustable down to 50% of rated maximum range
Standard target size (mild steel)	150 mm	210 mm	300 mm
Frequency of operation	30 Hz	10 Hz	10 Hz
Repeatability	<3%	<3%	<3%
Hysteresis (maximum)	10–15%	10–15%	10–15%
Time delay before availability	300 ms	300 ms	300 ms
Circuit protection	Short-circuit protection with auto reset	Short-circuit protection with auto reset	Short-circuit protection with auto reset
Operating temperature	–13 to 158 °F (–25 to 70 °C) ①	–13 to 158 °F (–25 to 70 °C) ①	–13 to 158 °F (–25 to 70 °C) ①
Temperature drift	±10%	±10%	±10%
Enclosure rating	NEMA 4, 4X, 6, 6P, 12 and 13 (IP67)	NEMA 4, 4X, 6, 6P, 12 and 13 (IP67)	NEMA 4, 4X, 6, 6P, 12 and 13 (IP67)
Indicator LEDs	Output status	Output status	Output status
Materials of construction	PPS housing	PPS housing; aluminum baseplate	PPS housing; aluminum baseplate

Four-Wire

Description	DC Four-Wire		
	Small Diameter	Medium Diameter	Large Diameter
Operating voltage	10–42 Vdc	10–42 Vdc	10–42 Vdc
Load current (maximum)	300 mA	300 mA	300 mA
Burden current	<25 mA	<25 mA	<25 mA
Off-state leakage	<150 µA per output	<150 µA per output	<150 µA per output
Voltage drop	<2.5 V	<2.5 V	<2.5 V
Outputs	1 NO/1 NC (complementary)	1 NO/1 NC (complementary)	1 NO/1 NC (complementary)
Sensing range (maximum)	50 mm	70 mm	100 mm
Range adjustment	Not adjustable	Potentiometer adjustable down to 50% of rated maximum range	Potentiometer adjustable down to 50% of rated maximum range
Standard target size (mild steel)	150 mm	210 mm	300 mm
Frequency of operation	70 Hz	40 Hz	30 Hz
Repeatability	<3%	<3%	<3%
Hysteresis (maximum)	10–15%	10–15%	10–15%
Time delay before availability	300 ms	300 ms	300 ms
Circuit protection	Short-circuit protection with auto reset	Short-circuit protection with auto reset	Short-circuit protection with auto reset
Operating temperature	–13 to 158 °F (–25 to 70 °C) ①	–13 to 158 °F (–25 to 70 °C) ①	–13 to 158 °F (–25 to 70 °C) ①
Temperature drift	±10%	±10%	±10%
Enclosure rating	NEMA 4, 4X, 6, 6P, 12 and 13 (IP67)	NEMA 4, 4X, 6, 6P, 12 and 13 (IP67)	NEMA 4, 4X, 6, 6P, 12 and 13 (IP67)
Indicator LEDs	Green: power; Red: output status	Green: power; Red: output status	Green: power; Red: output status
Materials of construction	PPS housing	PPS housing; aluminum baseplate	PPS housing; aluminum baseplate

Note

① Small diameter DC unshielded models are rated at –40 °F (–40 °C). All other models can be operated at –40 °F (–40 °C), but range drift will occur.

Wiring Diagrams

Pin numbers are for reference, rely on pin location when wiring.

E56 Pancake Sensors

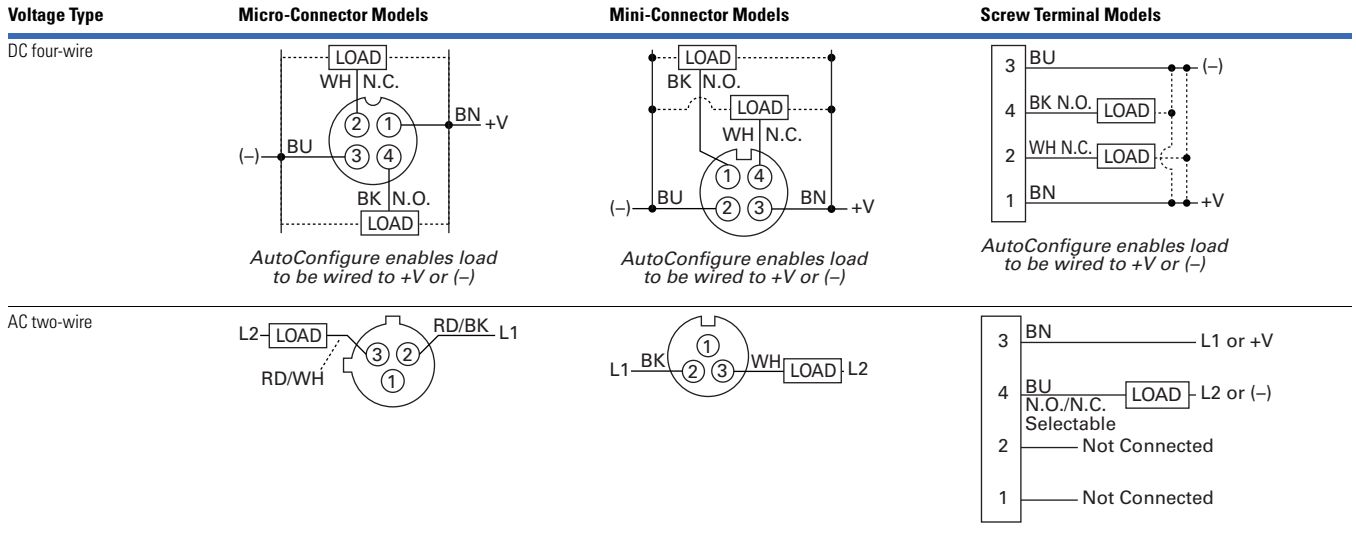

Dimensions

Approximate Dimensions in Inches (mm)

E56 Pancake Sensors

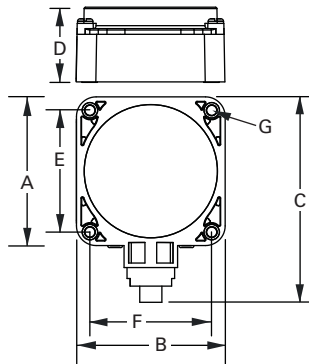

Model	A (Depth)	B (Width)	C (Depth)	D (Height)	E (Mounting)	F (Mounting)	G (Diameter)
Small Diameter Models							
Micro-connector	3.13 (79.0)	3.13 (79.0)	4.32 (110.0)	1.54 (39.0)	2.56 (65.0)	2.56 (65.0)	0.21 (5.0)
Mini-connector	3.13 (79.0)	3.13 (79.0)	4.67 (119.0)	1.54 (39.0)	2.56 (65.0)	2.56 (65.0)	0.21 (5.0)
Screw terminal	3.13 (79.0)	3.13 (79.0)	3.87 (92.0)	1.54 (39.0)	2.56 (65.0)	2.56 (65.0)	0.21 (5.0)
Medium Diameter Models							
Micro-connector	4.35 (110.0)	4.35 (110.0)	4.94 (125.4)	1.63 (41.0)	3.625 (92.0)	3.625 (92.0)	0.218 (5.5)
Mini-connector	4.35 (110.0)	4.35 (110.0)	5.29 (134.4)	1.63 (41.0)	3.625 (92.0)	3.625 (92.0)	0.218 (5.5)
Large Diameter Models							
Micro-connector	6.75 (171.5)	6.75 (171.5)	7.26 (184.4)	2.66 (67.5)	5.875 (149.0)	5.875 (149.0)	0.266 (7.0)
Mini-connector	6.75 (171.5)	6.75 (171.5)	7.61 (193.3)	2.66 (67.5)	5.875 (149.0)	5.875 (149.0)	0.266 (7.0)

3.12 Inductive Proximity Sensors

Nonmetallic Tubular Sensors

Nonmetallic Tubular Sensors



3

Nonmetallic Tubular Sensors

Product Description

E55 Tubular Inductive Proximity Sensors by Eaton's Electrical Sector are constructed of corrosion resistant PBT plastic. They are ideally suited for wash down applications such as those found in food processing plants. They are available in 12 mm, 18 mm and 30 mm diameters, shielded or unshielded. Shielded units can be embedded in metallic surfaces.

Features

- Models available that operate on two-wire AC or three-wire DC power
- Threaded tubular housings in three diameters allow easy integration into new and existing applications
- Nonmetallic construction offers excellent resistance to corrosion
- Output indicator LED is standard on all models

Contents

Description

	<i>Page</i>
Nonmetallic Tubular Sensors	
Product Selection	V8-T3-77
Technical Data and Specifications	V8-T3-78
Wiring Diagrams	V8-T3-78
Dimensions	V8-T3-78

DANGER

THIS SENSOR IS NOT A SAFETY DEVICE AND IS NOT INTENDED TO BE USED AS A SAFETY DEVICE. This sensor is designed only to detect and read certain data in an electronic manner and perform no use apart from that, specifically no safety-related use. This sensor product does not include self-checking redundant circuitry, and the failure of this sensor product could cause either an energized or de-energized output condition, which could result in death, serious bodily injury, or property damage.



For the most current information on this product, visit our Web site: www.eaton.com

For Customer Service in the U.S. call 1-877-ETN CARE (386-2273), in Canada call 1-800-268-3578. For Application Assistance in the U.S. and Canada call 1-800-426-9184.



Product Selection

Nonmetallic Tubular Sensors

Two-Wire Sensors ^①

	Operating Voltage	Sensing Range (Sn)	Shielding	Connection Type	NO Output Catalog Number	NC Output Catalog Number
12 mm 	12 mm Diameter					
	20–250 Vac 50/60 Hz	2 mm	Shielded	2-meter cable	E55CAL12A2	E55CBL12A2
4 mm		Unshielded	2-meter cable	E55CAL12A2E	E55CBL12A2E	
18 mm 	18 mm Diameter					
	20–250 Vac 50/60 Hz	5 mm	Shielded	2-meter cable	E55CAL18A2	E55CBL18A2
8 mm		Unshielded	2-meter cable	E55CAL18A2E	E55CBL18A2E	
30 mm 	30 mm Diameter					
	20–250 Vac 50/60 Hz	10 mm	Shielded	2-meter cable	E55CAL30A2	E55CBL30A2
15 mm		Unshielded	2-meter cable	E55CAL30A2E	E55CBL30A2E	

Three-Wire Sensors ^①

	Operating Voltage	Sensing Range (Sn)	Shielding	Connection Type	NO Output Catalog Number	NC Output Catalog Number
12 mm 	12 mm Diameter					
	10–30 Vdc	2 mm	Shielded (NPN)	2-meter cable	E55CAL12T110	E55CBL12T110
			Shielded (PNP)	2-meter cable	E55CAL12T111	E55CBL12T111
		4 mm	Unshielded (NPN)	2-meter cable	E55CAL12T110E	E55CBL12T110E
Unshielded (PNP)			2-meter cable	E55CAL12T111E	E55CBL12T111E	
18 mm 	18 mm Diameter					
	10–30 Vdc	5 mm	Shielded (NPN)	2-meter cable	E55CAL18T110	E55CBL18T110
			Shielded (PNP)	2-meter cable	E55CAL18T111	E55CBL18T111
		8 mm	Unshielded (NPN)	2-meter cable	E55CAL18T110E	E55CBL18T110E
Unshielded (PNP)			2-meter cable	E55CAL18T111E	E55CBL18T111E	
30 mm 	30 mm Diameter					
	10–30 Vdc	10 mm	Shielded (NPN)	2-meter cable	E55CAL30T110	E55CBL30T110
			Shielded (PNP)	2-meter cable	E55CAL30T111	E55CBL30T111
		15 mm	Unshielded (NPN)	2-meter cable	E55CAL30T110E	E55CBL30T110E
Unshielded (PNP)			2-meter cable	E55CAL30T111E	E55CBL30T111E	

Note

^① For a selection of mounting brackets and other accessories for use with these sensors, see **Tab 8, section 8.2**.

3.12

Inductive Proximity Sensors

Nonmetallic Tubular Sensors

3

Technical Data and Specifications

Nonmetallic Tubular Sensors

Description	Two-Wire AC Models	Three-Wire DC Models
Operating voltage	20–250 Vac, 50/60 Hz	10–30 Vdc
Maximum load current	150 mA	200 mA
Switching frequency		
12 mm	25 Hz	2000 Hz (shielded); 1000 Hz (unshielded)
18 mm	25 Hz	1000 Hz (shielded); 500 Hz (unshielded)
30 mm	25 Hz	300 Hz (shielded); 150 Hz (unshielded)
Protection	—	Short circuit and reverse polarity
Temperature range	–13 to 158 °F (–25 to 70 °C)	–13 to 158 °F (–25 to 70 °C)
Enclosure material	Polybutylene Teraphtalate (PBT)	Polybutylene Teraphtalate (PBT)
Enclosure rating	NEMA 3, 3S, 4, 4X, 13 (IP66)	NEMA 3, 3S, 4, 4X, 13 (IP66)
Indicator LED	Lights when output is ON	Lights when output is ON

Wiring Diagrams

Nonmetallic Tubular Sensors

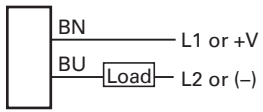
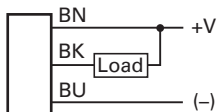
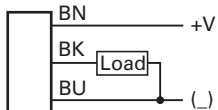
Operating Voltage	Output	Cable Models	Operating Voltage	Output	Cable Models
Two-Wire Sensors			Three-Wire Sensors		
20–250 Vac 50/60 Hz	All		10–30 Vdc	NPN	
				PNP	

Dimensions

Approximate Dimensions in Inches (mm)

12 and 18 mm

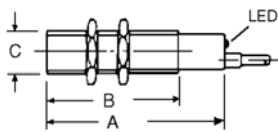

A	B	Thread Size C
12 mm		
2.17 (55)	1.77 (45)	M12 x 1
18 mm		
2.17 (55)	1.77 (45)	M18 x 1

30 mm

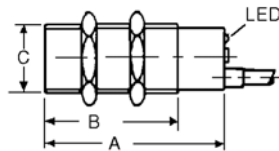

A	B	Thread Size C
3.15 (80)	2.36 (60)	M30 x 1.5

E52 Cube Style Sensors



Contents

<i>Description</i>	<i>Page</i>
E52 Cube Style Sensors	
Product Selection	
E52 Cube Style Sensors	V8-T3-80
Compatible Connector Cables	V8-T3-80
Technical Data and Specifications	V8-T3-81
Wiring Diagrams	V8-T3-81
Dimensions	V8-T3-82

E52 Cube Style Sensors

Product Description

The E52 Cube Sensor from Eaton's Electrical Sector is a high performance inductive proximity sensor, providing long sensing ranges in a compact, industry-standard package.

The E52 Cube family features Eaton's Autoconfigure output technology, which automatically detects NPN or PNP wiring states and switches the sensor accordingly, without user intervention. The E52 also utilizes complementary outputs to further reduce the number of models needed to cover a wide array of inductive sensing applications. Individual power and output LEDs make installation and troubleshooting easy. Combine the above features with the range and five-way mounting flexibility of the E52 Cube family, and chances are there's an E52 solution to your sensing needs.

The E52 Cube was designed with the most heavy-duty applications in mind. Some of those applications include automotive manufacturing, aggregate machinery, and metalworking applications. Try the E52 Cube in some of your most demanding applications today.

Application Description

Typical Applications

- Automotive manufacturing
- Metalworking
- Machinery OEMs
- Pipe and rod manufacturing
- Block and brick manufacturing equipment
- Amusement parks
- Heavy-duty trucks, cranes and lifts

Features

- Long inductive proximity ranges available (up to 40 mm sensing distance)
- Four-wire DC models have complementary outputs (1NO-1NC)
- Four-wire DC models use auto-configure technology, which allows the sensor to automatically adapt for NPN or PNP without user intervention
- Robust design featuring vibration and impact-absorbing potting compound
- Ideal for extreme temperatures or high pressure washdown environments

Standards and Certifications

- CE



DANGER

THIS SENSOR IS NOT A SAFETY DEVICE AND IS NOT INTENDED TO BE USED AS A SAFETY DEVICE. This sensor is designed only to detect and read certain data in an electronic manner and perform no use apart from that, specifically no safety-related use. This sensor product does not include self-checking redundant circuitry, and the failure of this sensor product could cause either an energized or de-energized output condition, which could result in death, serious bodily injury, or property damage.

For the most current information on this product, visit our Web site: www.eaton.com

For Customer Service in the U.S. call 1-877-ETN CARE (386-2273), in Canada call 1-800-268-3578.
For Application Assistance in the U.S. and Canada call 1-800-426-9184.

3.13

Inductive Proximity Sensors

E52 Cube Style Sensors

Product Selection

E52 Cube Style Sensors

3

DC Four-Wire Sensors





	Voltage Type	Output Configuration	Shielding	Output Type	Sensing Range	Connector Style	Catalog Number
Mini-Connector 	Cube Package (40 x 40 x 40 mm)						
	10–48 Vdc	NPN/PNP autoconfigure ①	Shielded	1 NO and 1 NC	15 mm	DC 4-pin micro	E52Q-DL15SAD01 ☹
			Unshielded	1 NO and 1 NC	15 mm	DC 4-pin mini	E52Q-DL15SAE01 ☹
	10–48 Vdc	NPN/PNP autoconfigure ①	Shielded	1 NO and 1 NC	20 mm	DC 4-pin micro	E52Q-DL20SAD01 ☹
						DC 4-pin mini	E52Q-DL20SAE01 ☹
			Unshielded	1 NO and 1 NC	20 mm	DC 4-pin micro	E52Q-DL20UAD01 ☹
DC 4-pin mini						E52Q-DL20UAE01 ☹	
25 mm			DC 4-pin micro	E52Q-DL25UAD01 ☹			
			DC 4-pin mini	E52Q-DL25UAE01 ☹			
30 mm	DC 4-pin micro	E52Q-DL30UAD01 ☹					
	DC 4-pin mini	E52Q-DL30UAE01 ☹					
35 mm	DC 4-pin micro	E52Q-DL35UAD01 ☹					
	DC 4-pin mini	E52Q-DL35UAE01 ☹					
40 mm	DC 4-pin micro	E52Q-DL40UAD01 ☹					
	DC 4-pin mini	E52Q-DL40UAE01 ☹					

Micro-Connector



Compatible Connector Cables

Standard Cables ②

	Current Rating at 600 V	Voltage Style	Number of Pins	Gauge	Length	Pin Configuration/Wire Colors (Face View Female Shown)	PVC Jacket Catalog Number	PUR Jacket Catalog Number	
Micro-Style Straight Female 	Micro-Style, Straight Female								
	—	DC	4-pin, 4-wire	22 AWG	6.0 ft (2m)		1-Brown 2-White 3-Blue 4-Black	CSDS4A4CY2202	CSDS4A4RY2202
					16.4 ft (5m)			CSDS4A4CY2205	CSDS4A4RY2205
32.8 ft (10m)					CSDS4A4CY2210			CSDS4A4RY2210	
Mini-Style Straight Female 	Mini-Style, Straight Female								
	10 A	AC/DC	4-pin, 4-wire	16 AWG	6.0 ft (2m)		1-Black 2-Blue 3-Brown 4-White	CSMS4A4CY1602	—
					13.1 ft (4m)			CSMS4A4CY1604	—
19.7 ft (6m)					CSMS4A4CY1606			—	

Notes

- ☹ See listing of compatible connector cables above.
- ① Autoconfigure technology allows the sensor to automatically adapt to NPN or PNP without user intervention.
- ② For a full selection of connector cables, see **Tab 10, section 10.1**.

Technical Data and Specifications

E52 Cube Style Sensors

Description	DC Four-Wire
Operating voltage	10–48 Vdc
Load current (maximum)	300 mA
Burden current	<25 mA
Off-state leakage	<150 μ A per output
Voltage drop	<2.5 V
Outputs	1 NO/1 NC (complementary)
Standard target size (mild steel)	120 mm
Frequency of operation	100 Hz
Repeatability	<3%
Hysteresis (maximum)	10–15%
Time delay before availability	300 ms
Circuit protection	Short-circuit protection with auto reset
Operating temperature ^①	–25 to 158 °F (–25 to 70 °C)
Temperature drift	\pm 10%
Enclosure rating	NEMA 4, 4X, 6, 6P, 12 and 13 (IP67, IP68)
Indicator LEDs	Green: power; Red: output status
Material of construction	Zinc alloy housing, PPS, PC

Wiring Diagrams

Pin numbers are for reference, rely on pin location when wiring.

E52 Cube Style Sensors

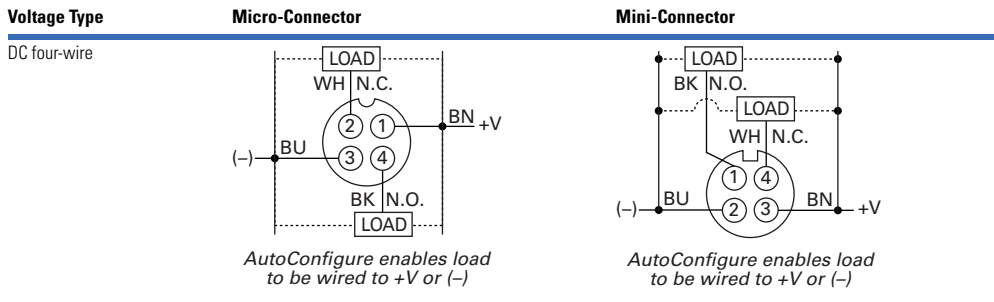

Note

^① Will operate at –40 °F (–40 °C), but range drift will occur.

3.13 Inductive Proximity Sensors

E52 Cube Style Sensors

Dimensions

Approximate Dimensions in Inches (mm)

E52 Cube Style Sensors

3

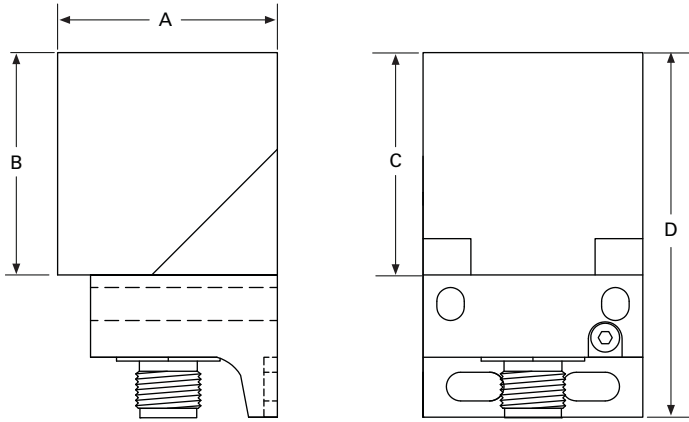

Model	Width A	Depth B	Height C	Overall Height D
Micro-connector	1.57 (40)	1.57 (40)	1.57 (40)	2.725 (69.2)
Mini-connector	1.57 (40)	1.57 (40)	1.57 (40)	2.965 (75.3)

E52 Rectangular Style Sensors

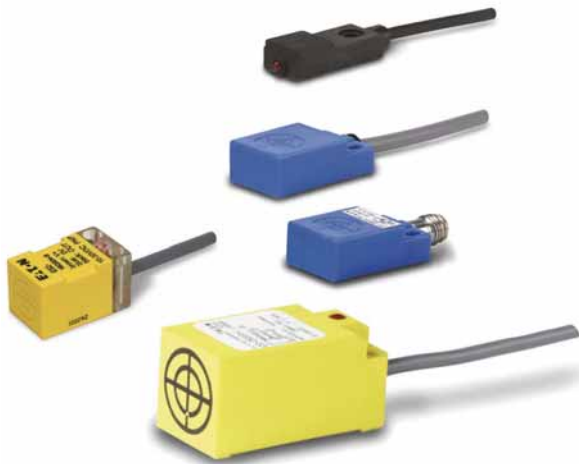

E52 Rectangular Style Sensors

Product Description

Rectangular E52 Inductive Proximity Sensors from Eaton's Electrical Sector feature a small, thin, compact space-saving design for applications where tubular type sensors cannot be used. Sensors are self-contained for direct connection to a logic circuit, relay, counter, programmable controller, and so on.

Features

- Small, low-profile design for use in space restrictive applications
- Three-wire DC operation
- Choose from a variety of sizes, and side or end sensing configurations
- Output indicator included on all models
- Epoxy filled cavities stop fluids from contacting any electrical component
- Convenient mounting holes integrated into each sensor housing

Contents

Description

E52 Rectangular Style Sensors

Product Selection

E52 Rectangular Style Sensors

Compatible Connector Cables

Technical Data and Specifications

Wiring Diagrams

Dimensions

Page

V8-T3-84

V8-T3-84

V8-T3-84

V8-T3-85

V8-T3-85

3

⚠ DANGER

THIS SENSOR IS NOT A SAFETY DEVICE AND IS NOT INTENDED TO BE USED AS A SAFETY DEVICE. This sensor is designed only to detect and read certain data in an electronic manner and perform no use apart from that, specifically no safety-related use. This sensor product does not include self-checking redundant circuitry, and the failure of this sensor product could cause either an energized or de-energized output condition, which could result in death, serious bodily injury, or property damage.

For the most current information on this product, visit our Web site: www.eaton.com

For Customer Service in the U.S. call 1-877-ETN CARE (386-2273), in Canada call 1-800-268-3578. For Application Assistance in the U.S. and Canada call 1-800-426-9184.

3.14





Inductive Proximity Sensors

E52 Rectangular Style Sensors

Product Selection



E52 Rectangular Style Sensors

Three-Wire Models

	Voltage	Sensing Range	Frequency	Shielding	Connection Type	NO Output Catalog Number	NC Output Catalog Number
R12 Side Sensing 	R12 Side Sensing						
	12–24 Vdc	0.12 in (3 mm)	Standard	Shielded (NPN)	1-meter cable	E52RAL12T110	—
				Shielded (PNP)	1-meter cable	E52RAL12T111	—
				Alternate	Shielded (NPN)	1-meter cable	E52RAL12T110AF
Shielded (PNP)				1-meter cable	E52RAL12T111AF	—	
Q16 End Sensing 	Q16 End Sensing						
	12–30 Vdc	0.20 in (5 mm)	Standard	Unshielded (NPN)	2-meter cable	E52-16QS04-C	E52-16QS04-C1
Unshielded (PNP)				2-meter cable	E52-16QS04-B	E52-16QS04-B1	
R18 Side Sensing 	R18 Side Sensing						
	10–30 Vdc	0.16 in (4 mm)	Standard	Unshielded (NPN)	2-meter cable	E52-18RU04-C	E52-18RU04-C1
					3-pin nano-connector	E52-18RU04-CN ☺	E52-18RU04-C1N ☺
				Unshielded (PNP)	2-meter cable	E52-18RU04-B	E52-18RU04-B1
3-pin nano-connector					E52-18RU04-BN ☺	E52-18RU04-B1N ☺	
Q25 End Sensing 	Q25 End Sensing						
	10–30 Vdc	0.39 in (10 mm)	Standard	Shielded (NPN)	2-meter cable	E52-25QS10-C	E52-25QS10-C1
Shielded (PNP)				2-meter cable	E52-25QS10-B	E52-25QS10-B1	

Compatible Connector Cables

Standard Cables ①

	Voltage Style	Number of Pins	Gauge	Length	Pin Configuration/Wire Colors (Face View Female Shown)	PVC Jacket Catalog Number	PUR Jacket Catalog Number
Nano-Style Straight Female 	Nano-Style, Straight Female						
	DC	3-pin	24 AWG	6.0 ft (2m)	 1-Brown 3-Blue 4-Black	CSNS3A3CY2402	CSNS3A3RY2402

Technical Data and Specifications

E52 Rectangular Style Sensors

Description	Specification
Input current	Less than 10 mA
Load current	100 mA maximum
Switching rate	500 operations per second
Circuit protection	Short circuit
Ambient temperature range	–13 to 130 °F (–10 to 55 °C)
Enclosure rating	NEMA 1, 2, 3, 3S, 4, 12 (IEC IP66)
Enclosure material	PBT composition
Output indicator LED	Lights when output is ON

Notes

- ☺ See listing of compatible connector cables above.
- ① For a full selection of connector cables, see **Tab 10, section 10.1**.

Wiring Diagrams

Pin numbers are for reference, rely on pin location when wiring.

E52 Rectangular Style Sensors

Operating Voltage	Output	Cable Models	Nano-Connector Models (Face View Male Shown)
Three-Wire Sensors			
DC	NPN		
	PNP		

Dimensions

Approximate Dimensions in Inches (mm) except where noted

E52 Rectangular Style Sensors

R12

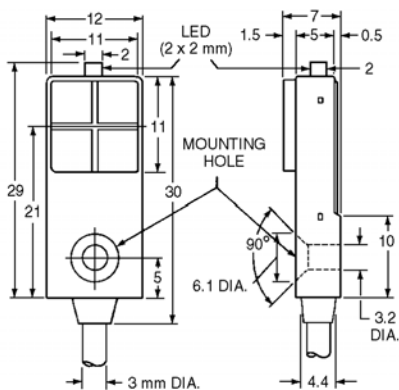

Note: Dimensions are mm only.

Q16

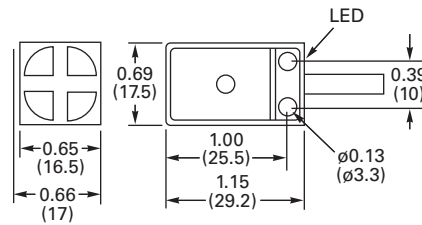

Q25

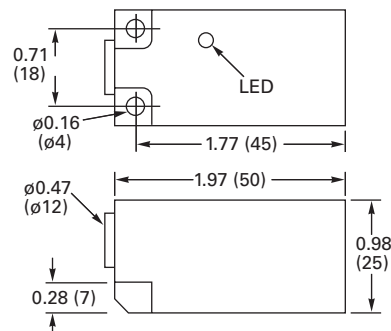

R18

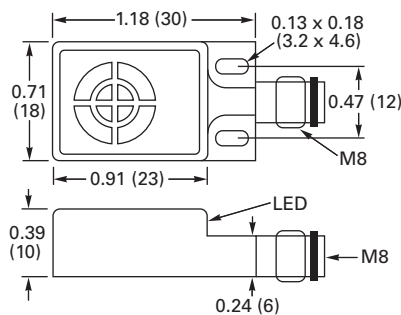
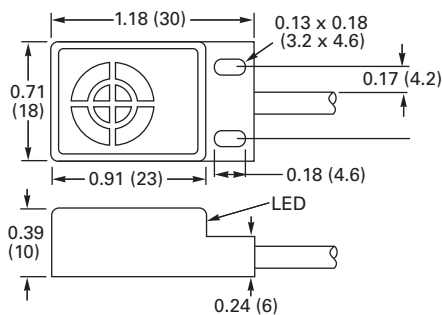

3.15

Inductive Proximity Sensors

E55 Limit Switch Style Sensors with Nonmetallic Housings

3

E55 Limit Switch Style Sensors with Nonmetallic Housings



Contents

Description

Page

E55 Limit Switch Style Sensors with Nonmetallic Housings	
Product Selection	V8-T3-86
Technical Data and Specifications	V8-T3-87
Wiring Diagrams	V8-T3-87
Dimensions	V8-T3-87

E55 Limit Switch Style Sensors with Nonmetallic Housings

Product Description

These sensors from Eaton's Electrical Sector feature PBT resin housings for high resistance to corrosion. The housing is sized to offer a direct replacement for standard limit switches. The unique sensing head is factory assembled for top sensing, but can be easily converted in the field to any one of four side sensing positions. Models are available with sensing ranges from 15 mm to 40 mm. The sensors can be wired for NO or NC operation.

Features

- Nonmetallic housing offers excellent resistance to corrosion
- Same form factor and mounting as standard limit switches for easy retrofit
- Sensor head features five sensing positions (top and all four sides) that can be easily changed in the field
- Long sensing ranges up to 40 mm

DANGER

THIS SENSOR IS NOT A SAFETY DEVICE AND IS NOT INTENDED TO BE USED AS A SAFETY DEVICE. This sensor is designed only to detect and read certain data in an electronic manner and perform no use apart from that, specifically no safety-related use. This sensor product does not include self-checking redundant circuitry, and the failure of this sensor product could cause either an energized or de-energized output condition, which could result in death, serious bodily injury, or property damage.

Product Selection

E55 Limit Switch Style Sensors

E55 Limit Switch

Two-Wire Sensors



Voltage Type	Sensing Range (Sn)	Shielding	Output	Connection Type	Catalog Number
35–250 Vac	15 mm	Shielded	NO or NC	Terminal wiring	E55BLT1C
	20 mm	Unshielded			E55BLT1D
	30 mm				E55BLT1E
	40 mm				E55BLT1F

For the most current information on this product, visit our Web site: www.eaton.com

For Customer Service in the U.S. call 1-877-ETN CARE (386-2273), in Canada call 1-800-268-3578. For Application Assistance in the U.S. and Canada call 1-800-426-9184.

Technical Data and Specifications

E55 Limit Switch Style Sensors

Description	Specification
Operating voltage	35–250 Vac
Maximum load current	400 mA
Switching frequency	25 Hz maximum
Leakage current	1.8 mA
Voltage drop	8V maximum
Inrush	5 A maximum for 20 ms
Indicator LEDs	Two LEDs: One lights when power is ON, the other lights when output is ON
Operating temperature	–13 to 158 °F (–25 to 70 °C)
Enclosure ratings	NEMA 4, 4X, 6, 12, 13 (IP67)
Housing material	PBT resin

Wiring Diagrams

Pin numbers are for reference, rely on pin location when wiring.

E55 Limit Switch Style Sensors

Operating Voltage	Output	Terminal Models
Two-Wire Sensors		
35–250 Vac ①	NO	
	NC	

Dimensions

Approximate Dimensions in Inches (mm)

E55 Limit Switch Style Sensors

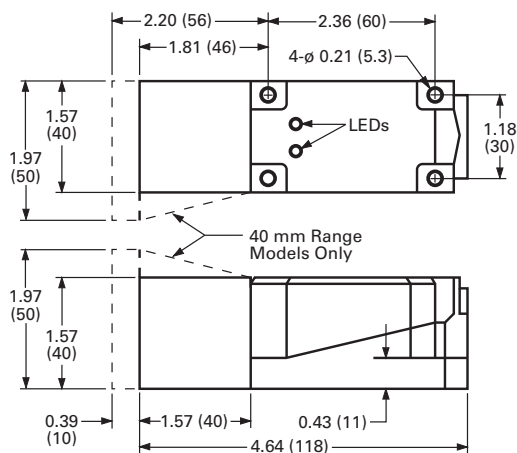

Note

① Switches are shipped as NO configuration. Internal jumpers must be moved to program for NC.

E51 Modular Limit Switch Style Sensors

3



Contents

<i>Description</i>	<i>Page</i>
E51 Modular Limit Switch Style Sensors	
Product Selection	
Standard Sensors—	
Assembled with Terminal Wiring	V8-T3-89
Standard Sensors—	
Assembled with Receptacles	V8-T3-90
Sensor Heads	V8-T3-90
Sensor Bodies	V8-T3-91
Logic Module	V8-T3-91
Receptacles	V8-T3-92
Compatible Connector Cables	V8-T3-93
Accessories	V8-T3-93
Technical Data and Specifications	V8-T3-94
Wiring Diagrams	V8-T3-94
Dimensions	V8-T3-95

E51 Modular Limit Switch Style Sensors

Product Description

The E51 Inductive Proximity Sensor family from Eaton's Electrical Sector combines high performance with a familiar limit switch style housing. Modular, plug-in components provide application flexibility, ease of maintenance, less downtime and reduced inventory. Choose from two-wire sensors with AC/DC operation, or four-wire sensors in either AC or DC styles. Connection options include terminal, mini-connector or various lengths of cable.

Choose from standard sensors that detect all types of metallic targets. The next page provides more detail on these sensors.

Features

- Rugged construction is ideal for industrial environments
- Viton gaskets ensure a positive seal and high resistance to industry chemicals
- Direct replacement for worn out limit switches
- Sensor heads and bodies feature captive screws to eliminate loss
- All sensor heads include a selector switch to program output function to either NO or NC
- Sensor bodies feature bifurcated engagement prongs for a reliable connection when plugging into receptacle stabs

Standards and Certifications

- UL Listed
- CSA Certified
- CE (where shown)



⚠ DANGER

THIS SENSOR IS NOT A SAFETY DEVICE AND IS NOT INTENDED TO BE USED AS A SAFETY DEVICE. This sensor is designed only to detect and read certain data in an electronic manner and perform no use apart from that, specifically no safety-related use. This sensor product does not include self-checking redundant circuitry, and the failure of this sensor product could cause either an energized or de-energized output condition, which could result in death, serious bodily injury, or property damage.

- Engagement key between sensor body and receptacle prevents improper assembly
- Sensors accommodate both U.S. and DIN mounting dimensions
- Wiring terminals feature captive pressure plate saddles for #18 to #12 AWG wire. A green screw identified ground terminal is also included
- Logic modules are available to provide additional control functions

For the most current information on this product, visit our Web site: www.eaton.com

For Customer Service in the U.S. call 1-877-ETN CARE (386-2273), in Canada call 1-800-268-3578. For Application Assistance in the U.S. and Canada call 1-800-426-9184.

Product Selection

Standard Sensors—Assembled with Terminal Wiring

Standard E51 sensors feature long sensing ranges and a choice of top or side sensing heads. Alternate frequency units eliminate interference when mounted close to standard frequency units. Order sensors in component form, as assembled plug-in units, or in a sealed version where the sensor body is factory assembled to an epoxy filled receptacle with tamper-proof screws to ensure a lasting seal.

Assembled Sensor



Assembled Sensors—Standard (with Terminal Wiring)

Sensor Body and Receptacle



Operating voltage	20–264 Vac/dc	Two-Wire Sensors		Four-Wire Sensors		10–30 Vdc
Output	NO or NC ①	120 Vac		NO and NC complementary		NO and NC complementary
Sensor body	E51SAL	E51SCL	E51SCN Accepts logic modules ②	E51SPL PNP	E51SNL NPN	
Receptacle ③	E51RA	E51RC	E51RCB	E51RN	E51RN	

Sensor Heads ①

Top Sensing



Sensing Range	Shielding	Frequency	Sensor Head Only Catalog Number	Assembled Sensors with Head, Sensor Body and Receptacle Catalog Number								
Top Sensing												
0.51 in (13 mm)	Shielded	Standard	E51DT1	E51ALT1	☐☐	E51CLT1	E51CNT1	E51PLT1	☐☐	E51NLT1	☐☐	
		Alternate	E51DT2	E51ALT2	☐☐	E51CLT2	E51CNT2	E51PLT2	☐☐	E51NLT2	☐☐	
0.94 in (24 mm)	Unshielded	Standard	E51DT5	E51ALT5	☐☐	E51CLT5	E51CNT5	E51PLT5	☐☐	E51NLT5	☐☐	
		Alternate	E51DT6	E51ALT6	☐☐	E51CLT6	E51CNT6	E51PLT6	☐☐	E51NLT6	☐☐	
Side Sensing												
0.51 in (13 mm)	Shielded	Standard	E51DS1	E51ALS1	☐☐	E51CLS1	E51CNS1	E51PLS1	☐☐	E51NLS1	☐☐	
		Alternate	E51DS2	E51ALS2	☐☐	E51CLS2	E51CNS2	E51PLS2	☐☐	E51NLS2	☐☐	
0.94 in (24 mm)	Unshielded	Standard	E51DS5	E51ALS5	☐☐	E51CLS5	E51CNS5	E51PLS5	☐☐	E51NLS5	☐☐	
		Alternate	E51DS6	E51ALS6	☐☐	E51CLS6	E51CNS6	E51PLS6	☐☐	E51NLS6	☐☐	

Side Sensing



Notes

① All sensor heads feature a programmable output selector switch for NO or NC operation. Operation is as follows:

For This Output Type:	Set Selector Position:	
	"TARGET"	"NO TARGET"
NO	Target present	Target absent
NC	Target absent	Target present

② Logic module must be ordered separately, see **Page V8-T3-91**. These sensor bodies are rated NEMA 4, 4X and 13.

③ Receptacles feature terminal wiring with a 1/2 in NPT thread at the conduit entrance. Other connection options are available:

Connection Option	Catalog Number	Code Suffix	Example
20 mm thread at the conduit entrance	—	20	E51ALT120
Mini-connector termination with epoxy filled receptacle, see Page V8-T3-92 for additional receptacle options	Two-wire, 3-pin connector	CSMS3F3CY1602	P3 E51ALT1P3
	Four-wire, 5-pin connector	CSMS5D5CY1602	P5 E51CLT1P5
Pre-wired cable with epoxy filled receptacle	8 ft long	—	S E51ALT1S
	12 ft long	—	S12 E51ALT1S12
	20 ft long	—	S20 E51ALT1S20

3.16

Inductive Proximity Sensors

E51 Modular Limit Switch Style Sensors

Standard Sensors—Assembled with Receptacles

Sensor body is attached to receptacle with tamper-proof screws.

Assembled Sensor



Assembled Sensors—Standard (with Epoxy Filled Receptacles and Pre-wired Cables)

Sensor Base Type with 8 ft Cable ^②



Operating voltage	Two-Wire Sensors 20–264 Vac/dc	Four-Wire Sensors 120 Vac	10–30 Vdc
Output	NO or NC ^①	NO and NC complementary	NO and NC complementary PNP NPN

Sensor Heads ^①

Top Sensing



Sensing Range	Shielding	Frequency	Sensor Head Only Catalog Number	Assembled Sensors with Head and Sensor Base Catalog Number						
Top Sensing										
0.51 in (13 mm)	Shielded	Standard	E51DT1	E51ALT16P	Ⓢ	E51CLT16P	E51PLT16P	Ⓢ	E51NLT16P	Ⓢ
		Alternate	E51DT2	E51ALT26P		E51CLT26P	E51PLT26P	Ⓢ	E51NLT26P	Ⓢ
0.94 in (24 mm)	Unshielded	Standard	E51DT5	E51ALT56P	Ⓢ	E51CLT56P	E51PLT56P	Ⓢ	E51NLT56P	Ⓢ
		Alternate	E51DT6	E51ALT66P	Ⓢ	E51CLT66P	E51PLT66P	Ⓢ	E51NLT66P	Ⓢ
Side Sensing										
0.51 in (13 mm)	Shielded	Standard	E51DS1	E51ALS16P	Ⓢ	E51CLS16P	E51PLS16P	Ⓢ	E51NLS16P	Ⓢ
		Alternate	E51DS2	E51ALS26P	Ⓢ	E51CLS26P	E51PLS26P	Ⓢ	E51NLS26P	Ⓢ
0.94 in (24 mm)	Unshielded	Standard	E51DS5	E51ALS56P	Ⓢ	E51CLS56P	E51PLS56P	Ⓢ	E51NLS56P	Ⓢ
		Alternate	E51DS6	E51ALS66P	Ⓢ	E51CLS66P	E51PLS66P	Ⓢ	E51NLS66P	Ⓢ

Side Sensing



Sensor Heads

Sensor Heads ^①

Top Sensing



Sensing Range	Shielding	Frequency	Target Material	Catalog Number
Top Sensing				
0.51 in (13 mm)	Shielded	Standard	All metals	E51DT1
		Alternate		E51DT2
0.94 in (24 mm)	Unshielded	Standard	All metals	E51DT5
		Alternate		E51DT6
Side Sensing				
0.51 in (13 mm)	Shielded	Standard	All metals	E51DS1
		Alternate		E51DS2
0.94 in (24 mm)	Unshielded	Standard	All metals	E51DS5
		Alternate		E51DS6

Side Sensing



Notes

^① All sensor heads feature a programmable output selector switch for NO or NC operation. Operation is as follows:

For This Output Type:	Set Selector Position:	
	"TARGET"	"NO TARGET"
NO	Target present	Target absent
NC	Target absent	Target present

^② Switch bases feature 8 ft of SOOW-A cable. Other connection options are available:

Connection Option ^③	Suffix	Example
Mini-connector mounted on 3 ft (0.9m) pigtail cable	T	E51ALT16PT
Mini-connector mounted to switch base	C	E51ALT16PC
Cable longer than 8 feet, add required length in 1 ft increments to listed catalog number—20 ft maximum	Length in ft	E51ALT16P12 for 12 ft

^③ See listing of compatible connector cables on **Page V8-T3-93**.

Sensor Bodies

Two-Wire Sensors

Operating Voltage	Output	Protection	Output Rating Continuous	Type	Catalog Number
AC/DC	AC/DC				
20–264 Vac/dc, 50/60 Hz	1 output, load powered, NO or NC, programmable from head; off state leakage current: <1.7 mA at 120 Vac/dc, <2.0 mA at 240 Vac	Latching short circuit and overload	0.5 A	—	E51SAL ^① CE



Four-Wire Sensors

Operating Voltage	Output	Protection	Output Rating Continuous	Type	Catalog Number
AC (E51SCN Shown)	AC				
120 Vac, 50/60 Hz	2 complementary outputs, line powered, NO and NC	—	1.0 A to 158 °F (70 °C), linearly derated to 0.6 A at 176 °F (80 °C)	—	E51SCL ^①
			1.0 A to 113 °F (45 °C), linearly derated to 0.3 A at 176 °F (80 °C)	—	E51SCN ^{②③}
DC	DC				
10–30 Vdc	2 complementary outputs, line powered, NO and NC	Reverse polarity	0.6 A to 104 °F (40 °C), linearly derated to 0.36A at 176 °F (80 °C)	NPN	E51SNL ^①
				PNP	E51SPL ^①



Logic Module

Logic Module (for E51SCN Sensor Body Only)

Type	Description	Timing Range ^④	Catalog Number
Logic Module ^⑤	ON and OFF delay Adjustable delay between time object is sensed and time switch function occurs Adjustable delay between time object leaves sensing field and time switch transfers back to non-sensing state	0.15 to 15.0 seconds	E51MTB



Notes

- ① This sensor body is available in a factory-sealed, non plug-in configuration (with 8-ft cable), add **6P** to listed catalog number. Example: E51SAL**6P**.
- ② Sensor body is black. E51SCN sensor bodies are rated NEMA 4, 4X and 13.
- ③ This sensor accepts logic modules, as seen in chart above.
- ④ Repeatability of the timing cycle is ±1% at constant voltage, ambient temperature and reset time.
- ⑤ Reset time is 25 ms minimum. Rated NEMA 4, 4X and 13.

3.16





Inductive Proximity Sensors

E51 Modular Limit Switch Style Sensors

Receptacles

Receptacles

3

	Description	Style	Details	Cable Length	Conduit Entrance 1/2 in NPT Catalog Number	20 mm Catalog Number
Surface Mount 	Surface Mount					
	Conduit entrance, front or rear mounting	Two-wire, AC/DC	—	—	E51RA	E51RA20
		Four-wire, AC	Gray	—	E51RC	E51RC20
			Black ①	—	E51RCB	E51RCB20
Four-wire, DC	—	—	E51RN	E51RN20		
Mini-Connector 	Mini-Connector					
	Epoxy filled receptacle with pre-wired mini-connector	Two-wire, AC/DC	3-pin	—	E51RAP3 ☺	—
		Four-wire, AC	5-pin	—	E51RCP5 ☺	—
Four-wire, DC		5-pin	—	E51RNP5 ☺	—	
Pigtail with Mini-Connector 	Pigtail with Mini-Connector					
	Epoxy filled receptacle with mini-connector mounted on 3 ft (0.9m) cable	Two-wire, AC/DC	3-pin	3 ft (0.9m)	E51RAPT3 ☺	—
		Four-wire, AC	5-pin	3 ft (0.9m)	E51RCP5T ☺	—
Four-wire, DC		5-pin	3 ft (0.9m)	E51RNPT5 ☺	—	
Pre-Wired Cable 	Pre-Wired Cable					
	Epoxy filled receptacle with pre-wired 16 gauge, yellow jacketed, type SOOW-A cable. Cable enters through hole threaded for conduit	Two-wire, AC/DC	3-conductor	8 ft (2.4m)	E51RAS	E51RA20S
				12 ft (3.6m)	E51RAS12	—
				20 ft (6m)	E51RAS20	—
		Four-wire, AC	5-conductor	8 ft (2.4m)	E51RCS	E51RC20S
				12 ft (3.6m)	E51RCS12	—
				20 ft (6m)	E51RCS20	—
		Four-wire, DC	5-conductor	8 ft (2.4m)	E51RNS	E51RN20S
				12 ft (3.6m)	E51RNS12	—
20 ft (6m)				E51RNS20	—	





Notes

☺☺ See listing of compatible connector cables on [Page V8-T3-93](#).

① Black receptacle is for color compatibility with E51SCN sensor body.





Compatible Connector Cables

Standard Cables ^①

	Current Rating at 600 V	Voltage Style	Number of Pins	Gauge	Length	Pin Configuration/Wire Colors (Face View Female Shown)	Catalog Number
Micro-Style Straight Female 	Micro-Style, Straight Female						
	13 A	—	3-pin	16 AWG	6 ft (2m)	 1-Green 2-Black 3-White	CSMS3F3CY1602
	10 A	AC/DC	4-pin, four-wire	16 AWG	6 ft (2m)	 1-Black 2-Blue 3-Brown 4-White	CSMS4A4CY1602
	8 A	—	5-pin	16 AWG	6 ft (2m)	 1-White 2-Red 3-Green 4-Orange 5-Black	CSMS5D5CY1602

Accessories

E51 Modular Limit Switch Style Sensors

	Description	Catalog Number
One Hole 	Universal Mounting Bracket One hole, includes mounting hardware, stainless steel	E51KH2
Two Holes 	Universal Mounting Bracket Two holes, includes mounting hardware, steel	E51KH4
Machine Mounting Bracket 	Machine Mounting Bracket Zinc die cast construction	E50KH3
Stand-Off Mounting Bracket 	Stand-Off Mounting Bracket Steel construction	E51KH3
Remote Sensor Head Assembly 	Remote Sensor Head Assembly Permits mounting sensor head up to 3 ft (0.9m) from sensor body	E51KRM

Dimensions, see Page V8-T3-95.

Note

^① For a full selection of connector cables, see Tab 10, section 10.1.

3.16

Inductive Proximity Sensors

E51 Modular Limit Switch Style Sensors

Technical Data and Specifications

E51 Modular Limit Switch Style Sensors

Description	Specification
Output rating (NEMA D150)	
AC/DC models	0.5 A continuous
AC models	1 A continuous
DC models	0.6 A continuous
Protection	Latching short-circuit protection on two-wire AC/DC models; DC models: resettable short-circuit protection
Switching rate	AC models: 15 Hz; DC models: 50 Hz
Indicator LEDs	Lights when output is ON. One LED for each output
Alternate frequency	Standard and alternate frequencies allow side-by-side operation without interference
Enclosure material	Zinc die cast
Gasket material	Viton
Enclosure ratings	NEMA 3, 3S, 4, 4X, 6, 6P, 12 and 13 (IP67); E51SCN sensor body only: NEMA 4, 4X and 13
Hazardous locations ratings	
Class I	Division II—GRPS ABCD
Class II	Division II—GRPS F and G
Class III	Division 2
Temperature range	-13 to 158 °F (-25 to 70 °C)
Torque requirements	Switch body screws: 25–30 in-lbs; sensing head screws: 14–18 in-lbs
Vibration	10–55 Hz, 1 mm amplitude
Shock	30 g, 11 ms, 1/2 sine wave
Humidity	95% non-condensing
Burden current	<25 mA
OFF-state leakage	DC version: 120 µA; two-wire AC: 1.9 mA maximum; three-wire AC: 1.1 mA
ON-state leakage	<2.5 Vdc
Power-up delay	<150 ms

Wiring Diagrams

Pin numbers are for reference, rely on pin location when wiring.

E51 Modular Limit Switch Style Sensors

Operating Voltage	Output	Terminal and Cable Models	Mini-Connector Models (Face View Male Shown)
Two-Wire Sensors			
20–264 Vac or Vdc 50/60 Hz	NO or NC (NO shown, can be changed to NC using switch on sensor head)		
Four-Wire Sensors			
120 Vac 50/60 Hz	NO and NC ①		
10–30 Vdc	NO and NC NPN ①		
	NO and NC PNP ①		

Note

① Changing output switch on sensor head will reverse output function (NO becomes NC, and NC becomes NO).

Dimensions

Approximate Dimensions in mm [in]

E51 Modular Limit Switch Style Sensors

Standard Sensors

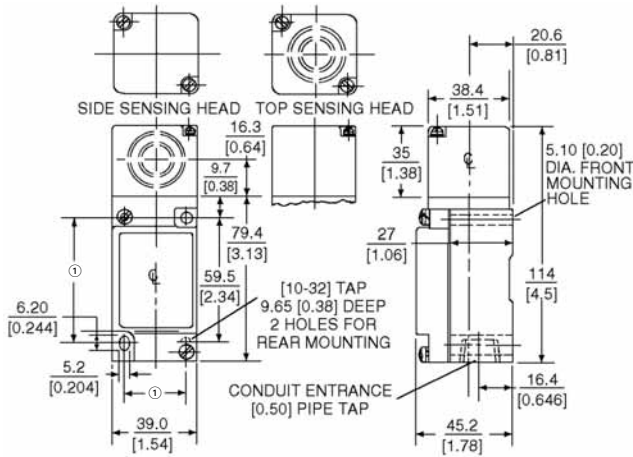

Sensor with Logic Module

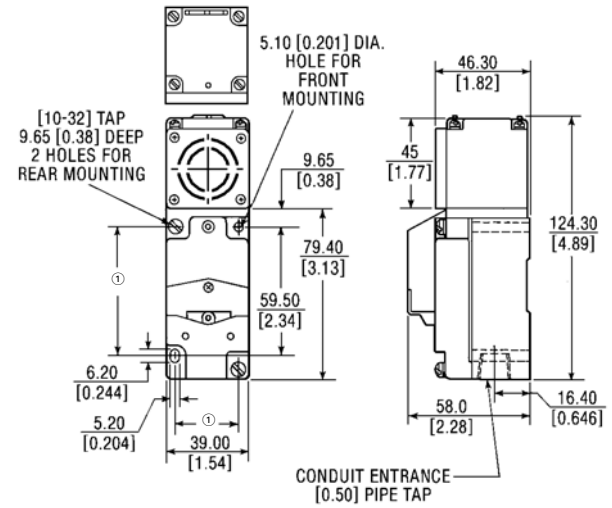

Accessories

Approximate Dimensions in Inches [mm]

Universal Mounting Bracket—One Hole

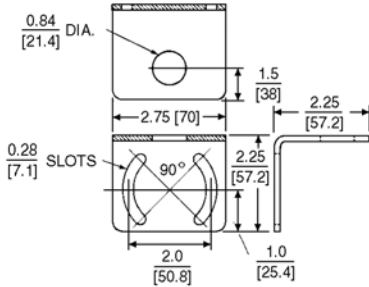

Universal Mounting Bracket—Two Holes

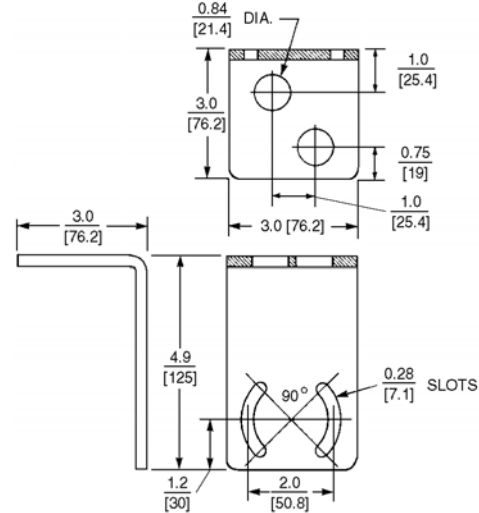

Note

① Can accommodate both U.S., 29.4 [1.16] x 59.5 [2.34] and DIN, 30 [1.18] x 60 [2.36], mounting dimensions are in mm [in].

3.16 Inductive Proximity Sensors

E51 Modular Limit Switch Style Sensors

Approximate Dimensions in mm [in]

Machine Mounting Bracket

3

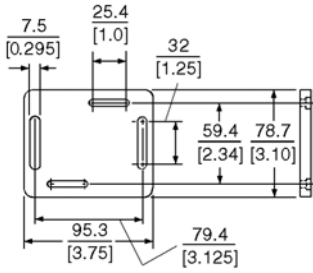

Stand-Off Mounting Bracket

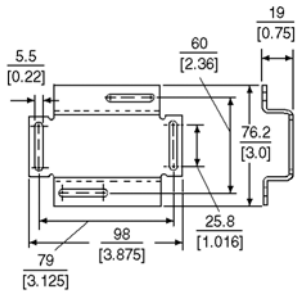

Remote Sensor Head Assembly

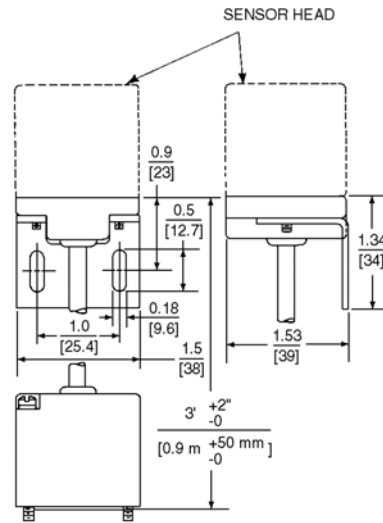

E51 Limit Switch Style, Factory Sealed 6P+ Sensors



Contents

<i>Description</i>	<i>Page</i>
E51 Limit Switch Style, Factory Sealed 6P+ Sensors	
Product Selection	
Unitized Sensors	V8-T3-98
Compatible Connector Cables	V8-T3-98
Accessories	V8-T3-99
Technical Data and Specifications	V8-T3-99
Wiring Diagrams	V8-T3-100
Dimensions	V8-T3-100

E51 Limit Switch Style, Factory Sealed 6P+ Sensors

Product Description

E51 6P+ Inductive Proximity Sensors from Eaton's Electrical Sector are fully sealed, pre-wired and designed specifically to ensure reliability under the most adverse of environmental conditions. They have been proven to withstand the penetrating properties of dirt, dust, grit, extreme temperatures and humidity. The unitized design eliminates plug-in connections that can lead to reliability problems in rugged environments.

Features

- The one-piece body and sensing head are both epoxy filled to protect internal components from contamination
- The head is hard-wired to the sensor body to ensure trouble-free performance
- Choose from top and side sensing heads
- Side sensing heads can be rotated to any of four positions
- Mounting dimensions allow direct replacement of worn out limit switches
- Rugged zinc die cast construction withstands physical abuse
- Connection options include pre-wired cable, body mounted connector and pigtail connector

DANGER

THIS SENSOR IS NOT A SAFETY DEVICE AND IS NOT INTENDED TO BE USED AS A SAFETY DEVICE. This sensor is designed only to detect and read certain data in an electronic manner and perform no use apart from that, specifically no safety-related use. This sensor product does not include self-checking redundant circuitry, and the failure of this sensor product could cause either an energized or de-energized output condition, which could result in death, serious bodily injury, or property damage.

For the most current information on this product, visit our Web site: www.eaton.com

For Customer Service in the U.S. call 1-877-ETN CARE (386-2273), in Canada call 1-800-268-3578.
For Application Assistance in the U.S. and Canada call 1-800-426-9184.

3.17

Inductive Proximity Sensors

E51 Limit Switch Style, Factory Sealed 6P+ Sensors

Product Selection

Unitized Sensors

3

Assembled Sensor with 8 ft Cable ^①



Sensor Heads ^②

Top Sensing ^②



Side Sensing ^②



Factory Sealed 6P+ Assembled Sensors

Sensing Range	Shielding	Frequency ^③	Two-Wire Sensors		Four-Wire Sensors			
			Operating voltage	Output	120 Vac	10–30 Vdc	NO and NC complementary	NO and NC complementary
			Assembled Sensor with Head, Sensor Body and Receptacle					
			Catalog Number					
Top Sensing								
0.51 in (13 mm)	Shielded	Standard	E51ALT16PU	E51BLT16PU	E51CLT16PU	E51PLT16PU	E51NLT16PU	
		Alternate	E51ALT26PU	E51BLT26PU	E51CLT26PU	E51PLT26PU	E51NLT26PU	
0.94 in (24 mm)	Unshielded	Standard	E51ALT56PU	E51BLT56PU	E51CLT56PU	E51PLT56PU	E51NLT56PU	
		Alternate	E51ALT66PU	E51BLT66PU	E51CLT66PU	E51PLT66PU	E51NLT66PU	
Side Sensing								
0.51 in (13 mm)	Shielded	Standard	E51ALS16PU	E51BLS16PU	E51CLS16PU	E51PLS16PU	E51NLS16PU	
		Alternate	E51ALS26PU	E51BLS26PU	E51CLS26PU	E51PLS26PU	E51NLS26PU	
0.94 in (24 mm)	Unshielded	Standard	E51ALS56PU	E51BLS56PU	E51CLS56PU	E51PLS56PU	E51NLS56PU	
		Alternate	E51ALS66PU	E51BLS66PU	E51CLS66PU	E51PLS66PU	E51NLS66PU	

Compatible Connector Cables

Standard Cables ^⑥

Mini-Style Straight Female



Current Rating at 600 V	Voltage Style	Number of Pins	Gauge	Length	Pin Configuration/Wire Colors (Face View Female Shown)	Catalog Number
Mini-Style, Straight Female						
13 A	—	3-pin	16 AWG	6 ft (2m)	1-Green 2-Black 3-White	CSMS3F3CY1602
10 A	—	4-pin	16 AWG	6 ft (2m)	1-Black 2-Blue 3-Brown 4-White	CSMS4A4CY1602
8 A	AC/DC	5-pin, 5-wire	16 AWG	6 ft (2m)	1-Black 2-Blue 3-Orange 4-Brown 5-White	CSMS5A5CY1602

Notes

^① Switch bases feature 8 ft of SOOW-A cable. Other connection options are available:

Connection Option ^④	Instructions	Example
Mini-connector mounted on 3 ft (0.9m) pigtail cable (3-pin for two-wire sensors; 5-pin for four-wire sensors)	Add the letter T before U	E51ALT16PTU
Mini-connector mounted to switch base (3-pin for two-wire sensors; 5-pin for four-wire sensors)	Add the letter C before U	E51ALT16PCU
Cable longer than 8 ft, add required length in 1 ft increments to listed catalog number—20 ft maximum	Add length in feet to end of catalog number	E51ALT16PU12 ^⑤

^② Sensor head is hard wired to sensor body and cannot be detached. Side sensing head can be unfastened and rotated to any of four positions.

^③ Sensor heads feature color coded target symbols: Yellow for standard frequency; Green for alternate frequency.





^④ See listing of compatible connector cables above.

^⑤ For 12 ft.

^⑥ For a full selection of connector cables, see **Tab 10, section 10.1**.

Accessories

E51 Limit Switch Style, Factory Sealed 6P+ ^①

	Description	Catalog Number
One Hole 	Universal Mounting Bracket Includes mounting hardware, stainless steel	E51KH2
Two Holes 	Includes mounting hardware, steel	E51KH4
Machine Mounting Bracket 	Machine Mounting Bracket Zinc die cast construction	E50KH3
Stand-Off Mounting Bracket 	Stand-Off Mounting Bracket Steel construction	E51KH3
Dimensions , see Page V8-T3-100 .		

Technical Data and Specifications

E51 Limit Switch Style, Factory Sealed 6P+

Description	Specification
Output rating (NEMA D150)	
AC/DC models	0.5 A continuous
AC models	1 A continuous
DC models	0.6 A continuous
Protection	Latching short-circuit protection on two-wire AC/DC and three-wire DC models
Switching rate	AC models: 15 Hz; DC models: 50 Hz
Indicator LEDs	Lights when output is ON. One LED for each output
Alternate frequency	Standard and alternate frequencies allow side-by-side operation without interference
Enclosure material	Cast metal
Gasket material	Zinc die cast
Enclosure ratings	NEMA 3, 3S, 4, 4X, 6, 6P, 12 and 13 (IP68)
Temperature range	-13 to 158 °F (-25 to 70 °C)
Torque requirements	Switch body screws: 25–30 in-lbs; sensing head screws: 14–18 in-lbs
OFF-state leakage	DC version: 120 µA; two-wire AC: 1.9 mA maximum; three-wire AC: 1.1 mA
ON-state leakage	<2.5 Vdc

Note

^① For a full selection of connector cables, see **Tab 10, section 10.1**.

3.17

Inductive Proximity Sensors

E51 Limit Switch Style, Factory Sealed 6P+ Sensors

Wiring Diagrams

Pin numbers are for reference, rely on pin location when wiring.

E51 Limit Switch Style, Factory Sealed 6P+

3

Operating Voltage

Output

Cable Models

**Mini-Connector Models
(Face View Male Shown)**

Two-Wire Sensors

20–264 Vac or Vdc 50/60 Hz NO or NC (NO shown)

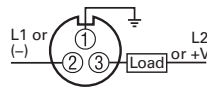
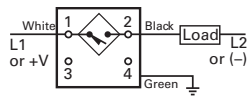

Four-Wire Sensors

120 Vac 50/60 Hz NO and NC

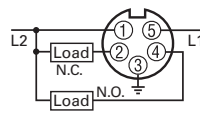
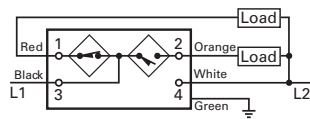

10–30 Vdc NO and NC NPN

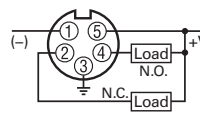
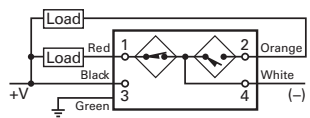

NO and NC PNP

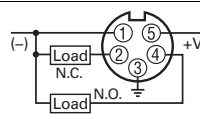
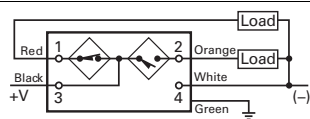

Dimensions

Approximate Dimensions in mm [in]

E51 Limit Switch Style, Factory Sealed 6P+

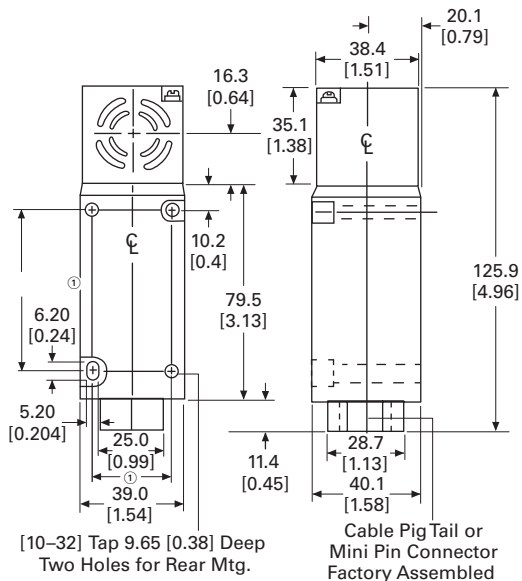

Note

① Can accommodate both U.S., 29.4 [1.16] x 59.5 [2.34] and DIN, 30 [1.18] x 60 [2.36], mounting dimensions.

Approximate Dimensions in Inches [mm]

Accessories

Universal Mounting Bracket—One Hole

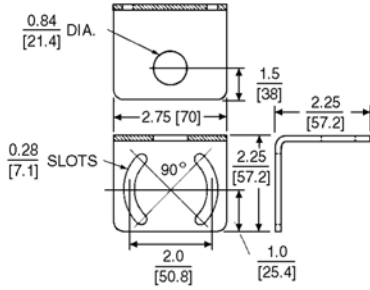

Universal Mounting Bracket—Two Holes

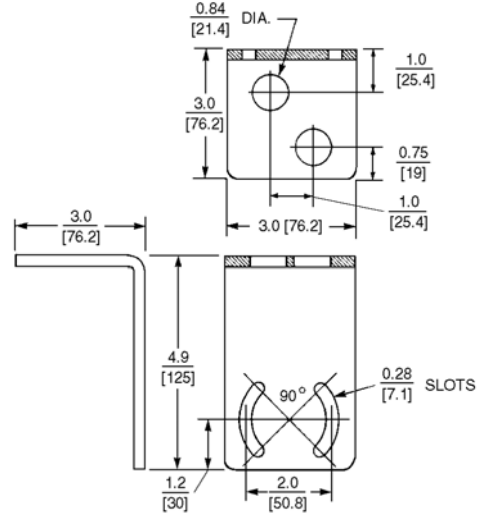

Approximate Dimensions in mm [in]

Machine Mounting Bracket

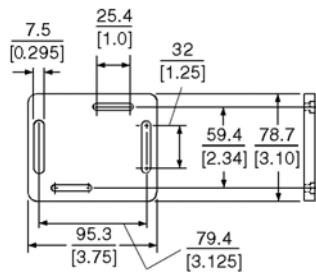

Stand-Off Mounting Bracket

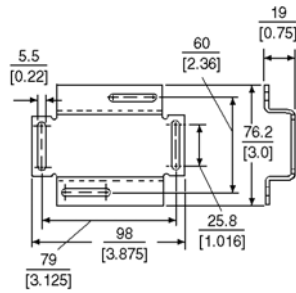

Note

- ① Can accommodate both U.S., 29.4 [1.16] x 59.5 [2.34] and DIN, 30 [1.18] x 60 [2.36], mounting dimensions.