



Model Number

NBN40-U4-A2

Features

- Sensor head bidirectional and rotatable
- 40 mm non-flush
- 4-wire DC
- 4 LEDs indicator for 360° visibility

Accessories

MH 04-2681F

Mounting aid for Varikont, +U1+ and +U9*

MHW 01

Modular mounting bracket

Technical Data

General specifications

Switching element function		PNP	NO/NC
Rated operating distance	s_n	40 mm	
Installation		non-flush	
Output polarity		DC	
Assured operating distance	s_a	0 ... 32.4 mm	
Reduction factor r_{Al}		0.31	
Reduction factor r_{Cu}		0.3	
Reduction factor r_{304}		0.74	
Reduction factor r_{Brass}		0.39	

Nominal ratings

Operating voltage	U_B	10 ... 30 V DC
Switching frequency	f	0 ... 150 Hz
Hysteresis	H	typ. 5 %
Reverse polarity protection		reverse polarity protected
Short-circuit protection		pulsing
Voltage drop	U_d	≤ 2 V
Operating current	I_L	0 ... 200 mA
Off-state current	I_r	0 ... 0.5 mA
No-load supply current	I_0	≤ 20 mA
Time delay before availability	t_v	80 ms
Operating voltage indicator		LED, green
Switching state indicator		LED, yellow

Functional safety related parameters

MTTF _d	1230 a
Mission Time (T _M)	20 a
Diagnostic Coverage (DC)	0 %

Ambient conditions

Ambient temperature	-25 ... 85 °C (-13 ... 185 °F)
---------------------	--------------------------------

Mechanical specifications

Connection type	screw terminals
Core cross-section	≤ 2.5 mm ²
Housing material	PA/metal with epoxy powder coating
Sensing face	PA
Housing base	metal
Degree of protection	IP68 / IP69K
Mass	225 g
Note	Tightening torque: 1.8 Nm (housing) Tightening torque: 1.0 Nm (Screw terminal)

Compliance with standards and directives

Standard conformity	
Standards	EN 60947-5-2:2007 IEC 60947-5-2:2007

Approvals and certificates

UL approval	cULus Listed, General Purpose
CCC approval	CCC approval / marking not required for products rated ≤ 36 V

Dimensions

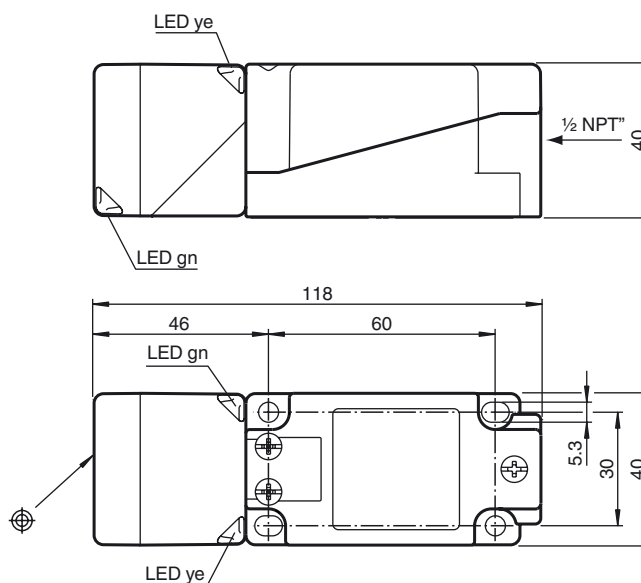

Electrical Connection

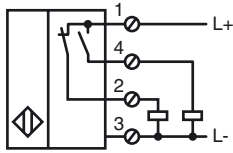

Release date: 2014-07-22 18:06 Date of issue: 2014-07-22 203101_eng.xml