

HENGSTLER

User Manual

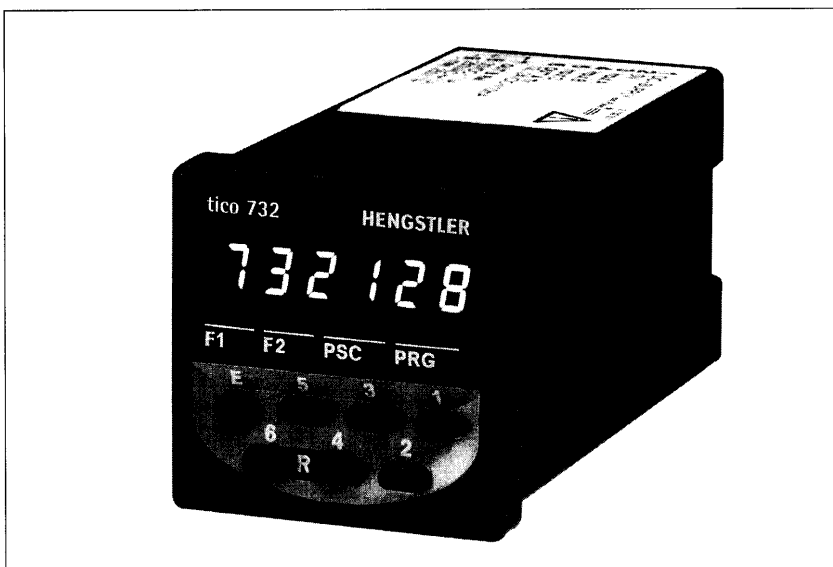
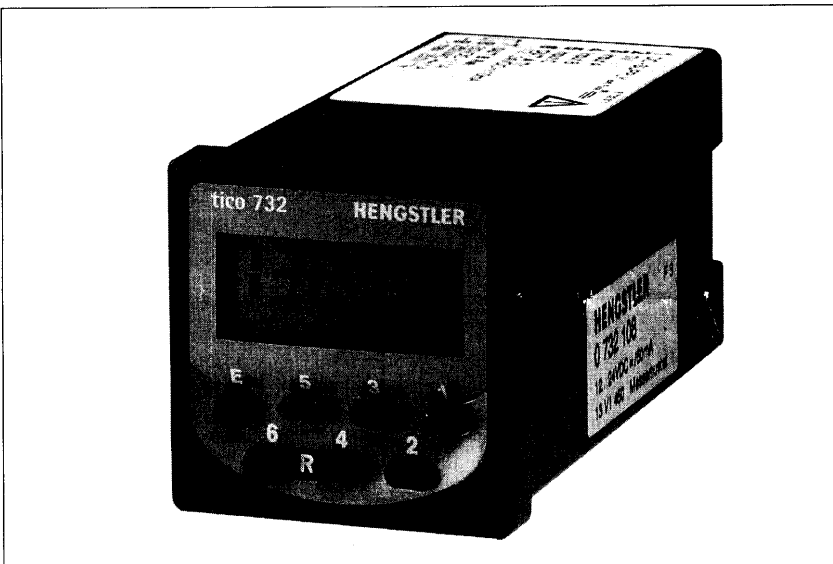

Bidirectional Multifunction-Counter **tico 732**

Sach-Nr. 2 732 021

DOC. 1.2.167.5 E

Contents

0.	Safety Instructions	2
1.	General information	3
1.1	Mounting and dimensional drawing.....	3
1.2	Connection.....	3
1.3	How to configure the multifunctional counter (0 732 0xx).....	4
1.4	Setting basic function.....	4
2.	Counter type	5
2.1	Function.....	5
2.2	Programming of functioncodes.....	6
2.3	Switching the display.....	7
2.4	Reset the display.....	7
2.5	Programming of Presets and Prescaler.....	7
3.	Tachometer type	8
3.1	Function.....	8
3.2	Programming of functioncodes.....	8
3.3	Programming of Presets and Prescaler.....	9
4.	Time-counter type	10
4.1	Function.....	10
4.2	Programming of functioncodes.....	11
4.3	Switching the display.....	12
4.4	Reset the display.....	12
4.5	Programming of Presets.....	12
5.	2-Shift counter type	13
5.1	Function.....	13
5.2	Programming of functioncodes.....	13
5.3	Switching the display.....	14
5.4	Reset the partial sums.....	14
5.5	Programming of Prescaler.....	14
6.	Batch-counter type	15
6.1	Function.....	15
6.2	Programming of functioncodes.....	15
6.3	Switching the display.....	17
6.4	Reset the display.....	17
6.5	Programming of Presets and Prescaler.....	17
7.	Specifications	18
8.	Ordering code	19

0. Safety Instructions

This instrument has been built and tested in accordance with VDE 0411, part1 (EN 61010, part 1), protection class II - Protection Measures for Electronic Measuring Instruments - and has left our works in safe and proper condition.

In order to maintain these conditions and to ensure safe operation, the user must observe the instructions and warnings provided in these operating instructions.



This symbol indicates passages in the text which you have to pay special attention to so as to guarantee proper use and preclude any risk.

- **Maximum operating voltages must not be exceeded!**

To prevent dangerous structure-borne currents, the counters with operating voltages 12-24 VDC or 24 VAC have to be run on safety extra-low voltage (SELV) and must be in an area of equipotential bonding.

For protection, please use an external fuse (see Electrical Specifications).

- Installation of electrical devices should **only** be carried out by a qualified electrician.
- Panel mounting devices should **only** be operated when properly mounted in the panel.
- Connection terminals are to be **protected** by proper installation.
- In order to ensure hand contact safety at the connection terminals, live wires must be connected properly to the connection terminals.
- Unassigned terminals (NC) **may not be connected!**
- If safe operation can no longer be ensured, the position indicator must be disabled and secured against accidental operation.
- Application: Industrial **processes** and control systems.
Overvoltage at the **connecting** terminals must be **limited** to the values within overvoltage category II.
- Installation environment and **wiring are influential** on the encoder's EMC:
Thus the installer must secure EMC of the whole facility (device).
- In electrostatically threatened areas please take care for neat ESD-protection of plug and connecting cable during installation work.

General

1. General information

1.1 Mounting and dimensional drawing

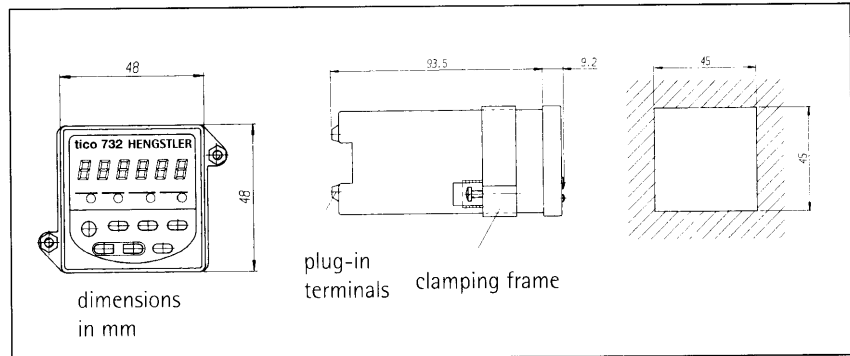

The indicators in the display have the following meaning:

F1: Preset 1

F2: Preset 2

PSC : Prescaler

PRG : Programming mode

In programming mode, the indicators F1, F2 or PSC together with the indicator PRG show the parameter to be changed (see chapter 2.3)

In counting mode, the indicators F1 or F2 show the active output (Out 1 or Out 2).

F1 and F2 light up if changed over to the alternative display (totalizer or batch).

1.2 Connection

The following connection diagrams show the **DC- and AC-Version with two presets**. On versions without preset or with only one preset, the corresponding terminals are marked with "NC" (not connected).

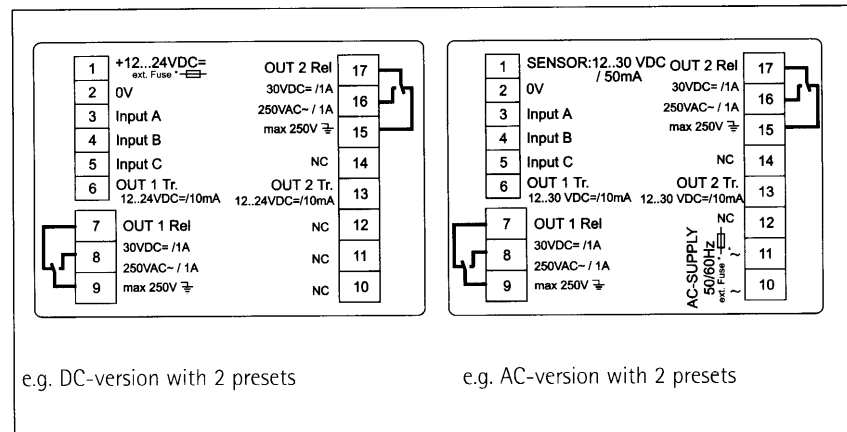

terminal	meaning
1 and 2	DC-Power supply (or DC-sensor supply only with AC-models)
3 and 4	programmable Count Inputs A and B, see table of function codes)
5	programmable Control Input (e.g. gate, reset; see table of function codes)
6 (and 13)	Transistor output for preset 1 (and preset 2) ¹
7, 8, 9 (and 15, 16, 17)	Change-over relays for preset 1 (and preset 2) ¹
10 and 11	AC-Power supply ²
12 and 14	not connected for safety reasons

¹ Only at products with presets

² Only at products with AC-power supply

General

1.3 How to configure the multifunctional version (0 732 0xx)

Important!

Please observe the following scheme:

Ordering code	function
0 732 0xx	multifunction, to be programmed as counter, tacho etc. (counter function is default).
0 732 1xx	counter
0 732 2xx	tachometer
0 732 3xx	time counter

All products with part number 0 732 0xx are multifunctional versions, which can be used as a counter, as a tachometer, as a time counter, as a 2-shift counter or a batch counter. If you have such product, please define now which function you need and configure it as described below.

If you have no multifunctional but a preconfigured product (e.g. a counter, a tachometer etc.), please go directly to the corresponding chapter.

1.4 Setting basic function

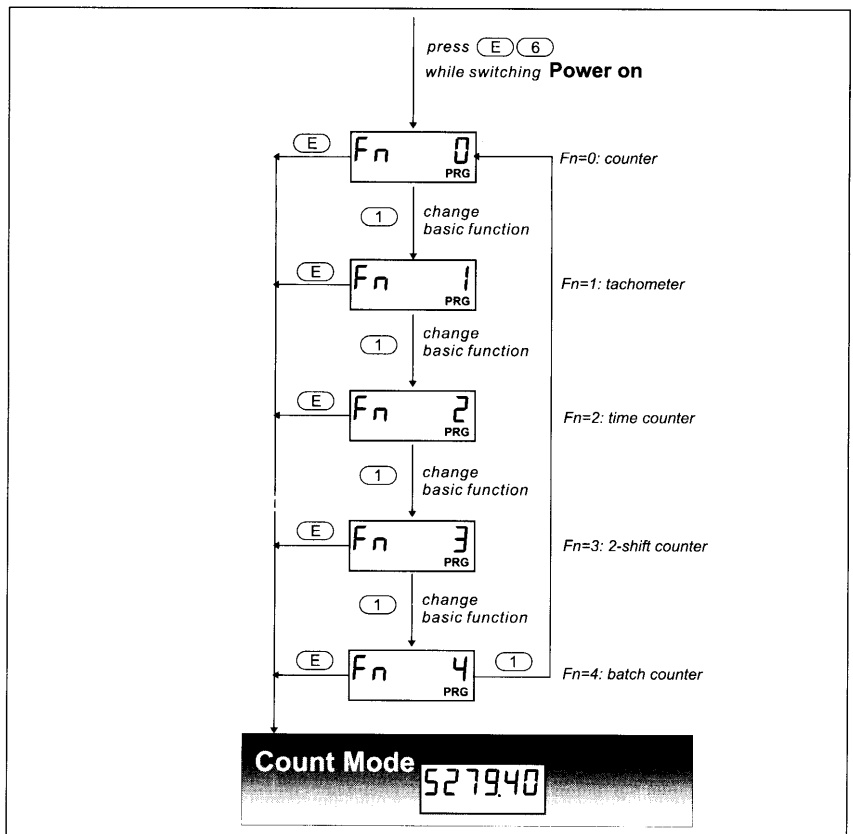

Hint for tachometer function:

The basicfunction tachometer is only defined for devices with no preset or 2 presets. If a device with only one preset is configured as a tachometer, it will operate as a tachometer with no presets.

Counter with Totalizer

2. Description of Counter type

2.1 Function

The basic function 0 is designed as pulse counter (for setting the basic function of multi-functional counter 0 732 0xx, see chapter 1.4).

The counter is working in coincidence mode, i.e. the output signals (Out 1 and Out 2) are active when the respective preselection is reached.

Various functions can be programmed via function codes (for details see chapter 2.2)

for example:

signal time: mono or bistable, can be programmed (see function code F6 and F7)
Important: If out 2 signal is bistable, reset can be done electrically or manually only.

reset mode: 3 possibilities:
manual (via reset keys 6+4), electrical (via Input C see function code F1), automatic (programmed via function code F4)

count mode: 8 modes can be programmed (see function code F1)

Example 1:

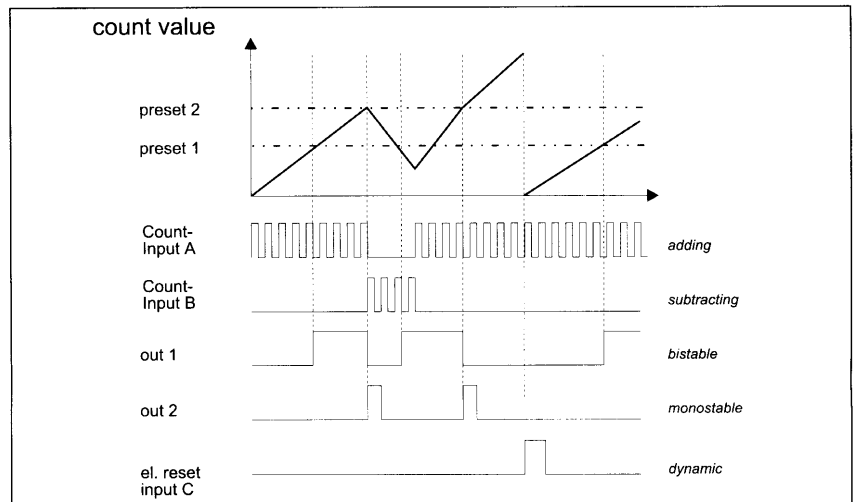

count mode: Input A adding, Input B subtracting, Input C reset (Function code F1=3)

signal time Out 1: bistable (F6=0n), will be deleted by Out 2

signal time Out 2: monostable (e.g. 20 ms, F7=0,02)

reset mode: reset to „0“, no autoreset (F4=0)
dynamic reset (F12=1)

Example 2:

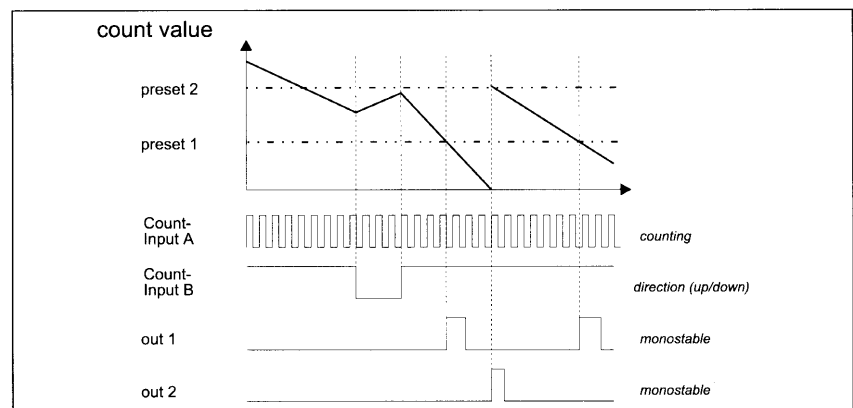

count mode: Input A counting, Input B direction, Input C reset (Function code F1=1)

signal time Out 1 and Out 2: monostable (e.g. 20 ms, F6/F7=0,02)

set mode: set to preset 2, with autoreset when reaching „0“ (F4=3)
dynamic reset (F12=1)

Counter with Totalizer

2.2 Programming of function codes

Programming mode:
 press while switching **(E) (5)**
 Power on

Change parameter:
 press **(1)**

Change to the next function:
 press **(E)**

Return to count mode:
 press > 5 sec **(E)**

F0 0
PRG

F1 0
PRG

F3 0
PRG

F4 0
PRG

F6 0.10
PRG

F7 0.10
PRG

F9 0
PRG

F10 1
PRG

F11 1
PRG

F12 0
PRG

F14 0
PRG

F15 0
PRG

function	code	alternatives/signification			
basic settings	F0	0*	no function		
		1	all function codes are set to the default values (*-marked)		
count mode	F1	0*	Input A	Input B	Input C
		1	count Input gate	reset	reset
		2	count Input direction(u/d)	reset	reset
		3	count Input direction(u/d)	gate	gate
		4	adding subtracting	reset	reset
		5	adding adding	gate	gate
		6	channel A ¹ channel B ¹	reset	reset
		7	channel A ¹ channel B ¹	gate	gate
decimal point (on display)	F3	0*	no decimal point		
		1	one decimal place (xxxx.x)		
		2	two decimal places (xxx.xx)		
		3	three decimal places (xxx.xxx)		
reset/setmode	F4	0*	reset to „0“, no autoreset		
		1	reset to „0“, with autoreset when reaching preset 2		
		2	set to preset 2, no autoreset		
		3	set to preset 2, with autoreset when reaching „0“		
signal time output 1	F6 ²	OFF	no Output signal		
		On	bistable Output signal (latching), will be deleted by Out 2		
		0,02	20 ms		
		0,05	50 ms		
		0,10*	100 ms		
		0,20	200 ms		
		0,50	500 ms		
		1,00	1 s		
signal time output 2	F7 ²	see above	see above; signal time output 1		
		see above	see above; signal time output 1		
Output with Reset	F9	0*	Do not activate the main preset output (OUT 2) ³ in case of reset		
		1	Activate the main preset (OUT 2) ³ in case of reset		
pnp/npn-selection	F10	0	npn (negative)		
		1*	pnp (positive)		
input attenuation	F11	0	30 Hz attenuation (for contacts)		
		1*	no attenuation, 5 kHz (bidirectional counting: 2,5 kHz)		
dyn./static Reset	F12	0*	static reset		
		1	dynamic reset (counting possible during resetting)		
output signal memory	F14	0*	after power fail, the signal times will not be restarted		
		1	after power fail, the signal times will be restarted		
additional totalizer	F15	0*	disabled		
		1	enabled		

* default values

¹ bidirectional counting with single evaluation (eg. for encoders with 2 channels A,B)

² parameter only appears for preset version

³ with appliances with one preset only, this applies to preset 1 and output 1 (OUT 1)

Counter with Totalizer

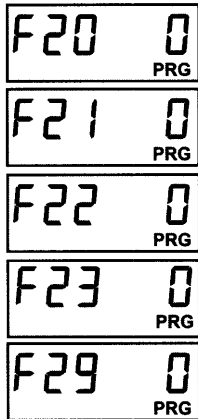

function	code	alternatives/signification
keylock for reset key 6+4	F20	0* key reset is possible
		1 key reset is not possible (or possible with delay see F29)
keylock for preset 1	F21 ²	0* access to preset 1 is possible
		1 access to preset 1 is not possible (or delayed see F29)
keylock for preset 2	F22 ²	0* access to preset 2 is possible
		1 access to preset 2 is not possible (or delayed see F29)
keylock for prescaler	F23	0* access to prescaler is possible
		1 access to prescaler is not possible (or delayed see F29)
keylock mode (F20-F23)	F29	0* access to parameters from F20-F23 is possible after holding the keys for more than 10 sec.
		1 access to parameter is not possible

* default values

² parameter only appears for preset version

2.3 Switching the display

(only with enabled totalizer;
see F15)

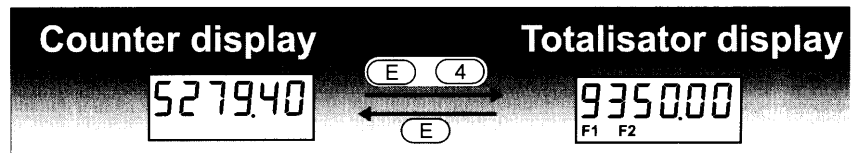

2.4 Reset the display

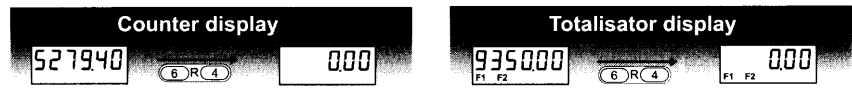

2.5 Programming of Presets and Prescaler

Hint:

If the new value is not confirmed by pressing the E-key, the return to the count mode will be done automatically after 15 sec without storing the new value.

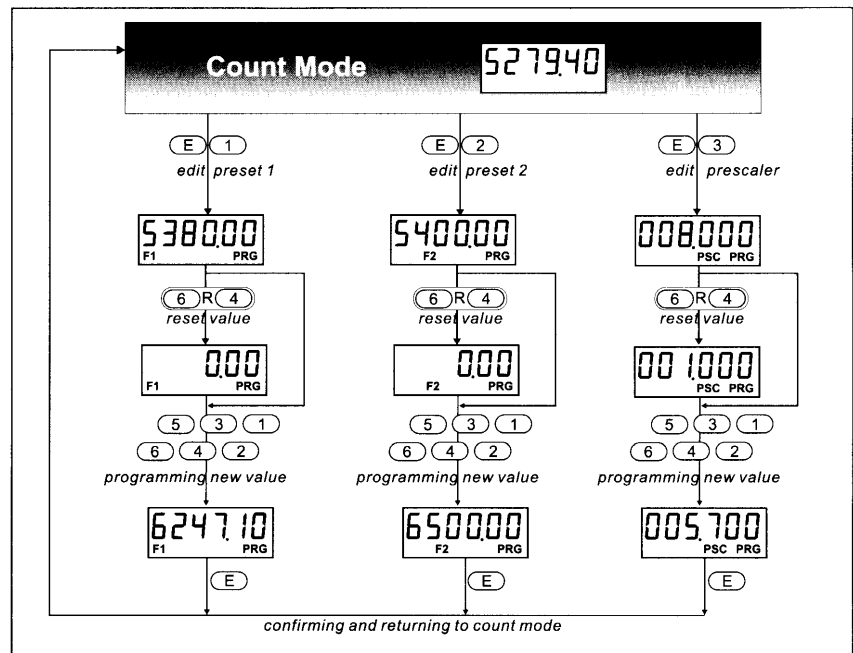

Tachometer

3. Tachometer type

The basic function 1 is designed as tachometer (for setting the basic function of multifunctional counter 0 732 0xx, see chapter 1.4).

With the tachometer, the period* (time interval between two rising edges) is measured, converted to 1/sec or 1/min, and displayed (see function code F2).

3.1 Function

* also called pulse interval measurement

3.2 Programming of functionscodes

Programming mode:

press while switching **(E) (5)** Power on

Change parameter:

press **(1)**

Change to the next function:

press **(E)**

Return to count mode:

press > 5 sec **(E)**

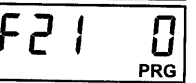
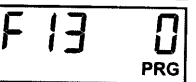
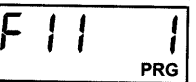
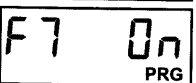
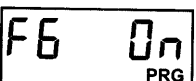
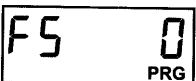
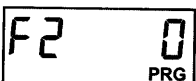
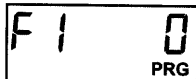
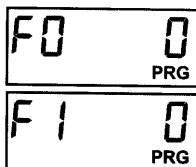

function	code	alternatives/signification
basic settings	F0	0* no function
		1 all function codes are set to the *-marked values
tacho mode	F1	Input A Input B Input C
		0* count Input - hold
		1 count Input direction(u/d) hold
		2 same as F1=1 above
		3 adding subtracting hold
		4 same as F1=3 above
		5 adding adding hold
		6 channel A' channel B' hold
	7 same as F1=6 above	
display unit	F2	0* display in 1/sec
		1 display in 1/min
decimal point (only display)	F3	0* no decimal point
		1 one decimal place (xxxx.x)
		2 two decimal places (xxxx.xx)
		3 three decimal places (xxx.xxx)
Minimum input frequency	F5	0* 1 Hz (if no further pulse occurs after 1 sec, the display goes back to "0")
		1 0,125 Hz (if no further pulse occurs after 8 sec, the display goes back to "0")
output 1	F6 ²	OFF no Output signal
		On* bistable Output signal
output 2	F7 ²	see above; output 1
pnp/npn-selection	F10	0 npn (negative)
		1* pnp (positive)
input attenuation	F11	0 30 Hz attenuation (for contacts)
		1* no attenuation, 5 kHz (bidirectional counting: 2,5 kHz)
start-up suppression	F13	0* without start-up suppression
		1 with start-up suppression
keylock for preset 1	F21 ²	0* access to preset 1 is possible
		1 access to preset 1 is not possible (or delayed see F29)

* default values

¹ bidirectional counting with single evaluation (eg. for encoders with 2 channels A,B)

² parameter only appears for 2 preset version

Tachometer

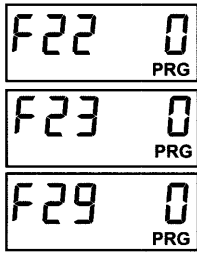

function	code	alternatives/signification	
keylock for preset 2	F22 ²	0*	access to preset 2 is possible
		1	access to preset 2 is not possible (or delayed see F29)
keylock for prescaler	F23	0*	access to prescaler is possible
		1	access to prescaler is not possible (or delayed see F29)
keylock mode for (F20-F23)	F29	0*	access to parameters from F20-F23 is possible after holding the keys for more than 10 sec.
		1	access to parameter is not possible

* default values

² parameter only appears for preset version

3.3 Programming of Presets¹ and Prescaler

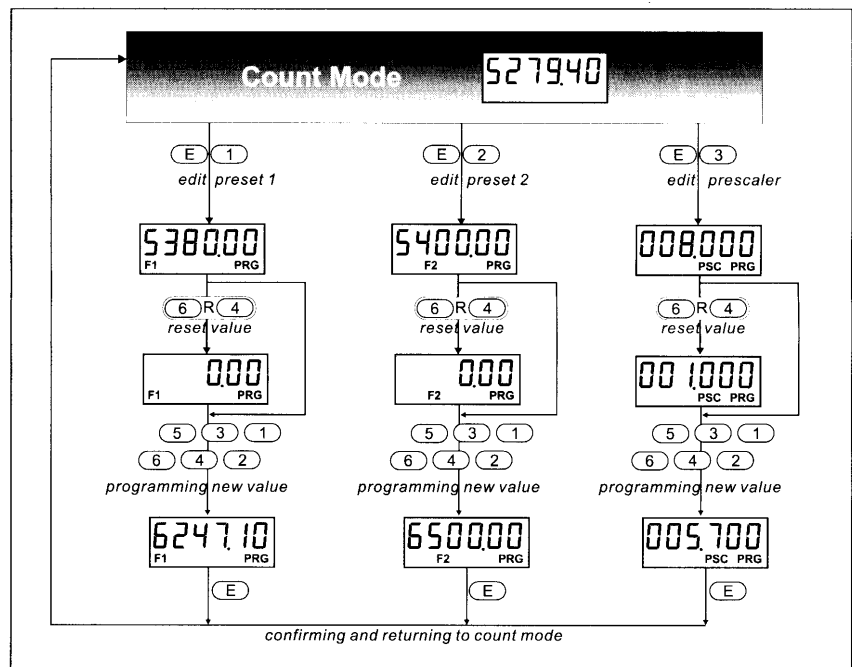

¹ No negative Presets programmable

Hint:

If the new value is not confirmed by pressing the E-key, the return to the count mode will be done automatically after 15 sec without storing the new value.

Time Counter with Totalizer

4. Time counter type

4.1 Function

The basic function 2 is designed as time counter (for setting the basic function of multi-functional counter 0 732 0xx, see chapter 1.4).

The time counter is working in coincidence mode, i.e. the output signals (Out 1 and Out 2) are active when the respective preselection is reached.

Various functions can be programmed via function codes (for details see chapter 4.2)

Input A, B, C have the following functions:

Input A: Start-Stop; pulse width measurement³ or period measurement⁴ programmable (F8)

Input B: Reset

Input C: Latch, If this Input is activated, the counting is not visible on the display. The new count value will be shown with the stop signal. (see example 2)

Example 1:

accumulated counting with pulse width measurement³ (F8=0)

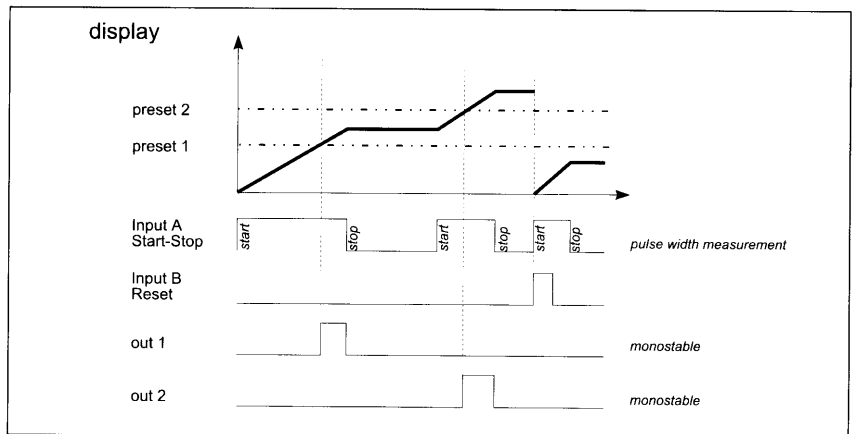

Example 2:

accumulated counting with period measurement (start-stop)⁴ (F8=1) and activated Latch (Input C)

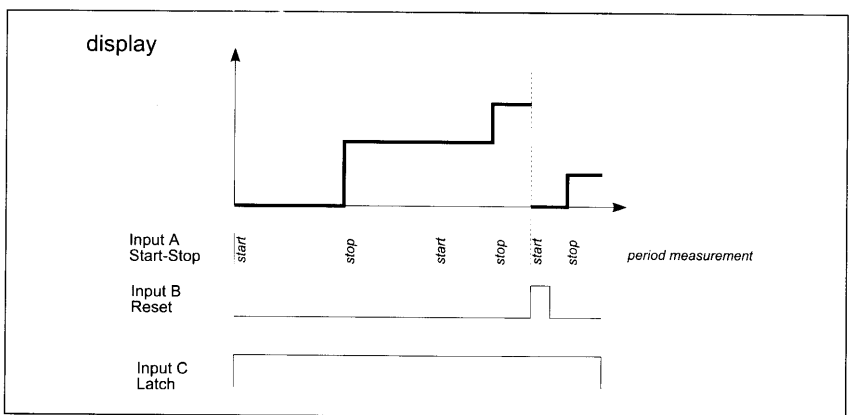

Example 3:

single counting⁵ with pulse width measurement³ (F8=2)

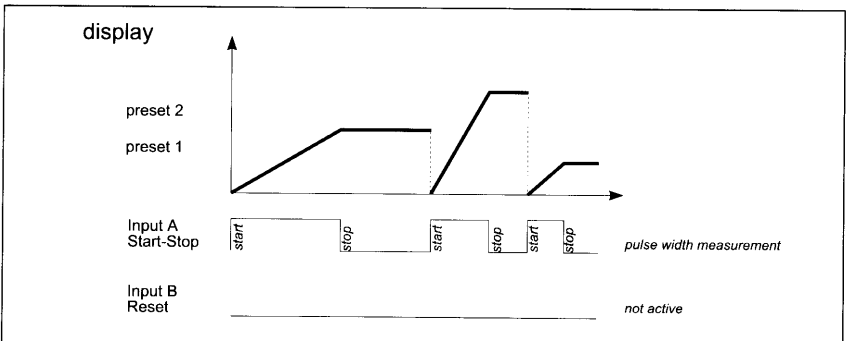

Example 4:

defining the time base:

Required time base: 0.01 hour
set time unit to hours (F2=2) and resolution (F3=2) to two decimal places. (xxxx.xx)

Time Counter with Totalizer

4.2 Programming of functionscodes

Programming mode:
 press while switching **(E) (5)** Power on

Change parameter:
 press **(1)**

Change to the next function:
 press **(E)**

Return to count mode:
 press > 5 sec **(E)**

F0 0
PRG

F2 0
PRG

F3 0
PRG

F4 0
PRG

F6 0.10
PRG

F7 0.10
PRG

F8 0
PRG

F9 0
PRG

F10 1
PRG

F11 1
PRG

F12 0
PRG

function	code	alternatives/signification
basic settings	F0	0* no function 1 all function codes are set to the *-marked values
time unit	F2	0* seconds 1 minutes 2 hours 3 format HH.MM.SS
resolution	F3	0* no decimal point 1 one decimal place (xxxx.x); 0.1 time unit 2 two decimal places (xxx.xx); 0.01 time unit 3 three decimal places (xxx.xxx); 0.001 time unit
reset/setmode	F4	0* reset to „0“, no autoreset 1 reset to „0“, with autoreset when reaching preset 2 ⁶ 2 set to preset 2 ⁶ , no autoreset 3 set to preset 2 ⁶ , with autoreset when reaching „0“
signal time output 1	F6 ¹	OFF no Output signal On bistable Output signal, will be deleted by Out 2 0,02 20 ms 0,05 50 ms 0,10* 100 ms 0,20 200 ms 0,50 500 ms 1,00 1 s
signal time output 2	F7 ¹	see above; signal time output 1 above
time counter mode	F8	0* cumulated counting with pulse width measurement ³ 1 cumulated counting with period measurement ⁴ 2 single counting with pulse width measurement ³ 3 single counting with period measurement ⁴
Output in case of reset	F9	0* Output from main preset (OUT 2) ² is not activated by reset 1 Output from main preset (OUT 2) ² is activated by reset
pnv/npn-selection	F10	0 npn 1* pnp
input attenuation	F11	0 30 Hz attenuation (for contacts) 1* no attenuation, 5 kHz (bidirectional counting: 2,5 kHz)
dyn./static Reset	F12	0* static reset 1 dynamic reset (counting possible during resetting)

* default values

¹ parameter only appears for preset version

² with appliances with one preset only, this applies to preset 1 and output 1 (OUT 1)

³ counting as long as Input A is active (see example 1)

⁴ counting starts and stops with the leading edge (see example 2).

⁵ with every start signal the counter starts again from zero

Time Counter with Totalizer

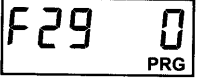
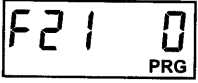
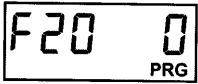
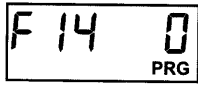

function	code	alternatives/signification
output signal memory	F14	0* after power fail, the signal times will not be restarted
		1 after power fail, the signal times will be restarted
additional totalizer	F15	0* disabled
		1 enabled
keylock for reset key 6+4	F20	0* key reset is possible
		1 key reset is not possible (or possible with delay see F29)
keylock for preset 1	F21 ¹	0* access to preset 1 is possible
		1 access to preset 1 is not possible (or delayed see F29)
keylock for preset 2	F22 ¹	0* access to preset 2 is possible
		1 access to preset 2 is not possible (or delayed see F29)
keylock mode for (F20-F23)	F29	0* access to parameters from F20-F22 is possible after holding the keys for more than 10 sec.
		1 access to parameter is not possible

* default values

¹ parameter only appears for preset version

4.3 Switching the display

(only with enabled totalizer; see F15)

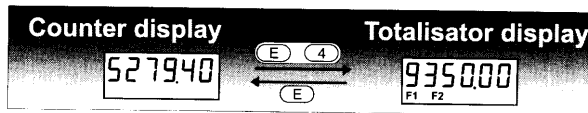

4.4 Reset the display



4.5 Programming of Presets

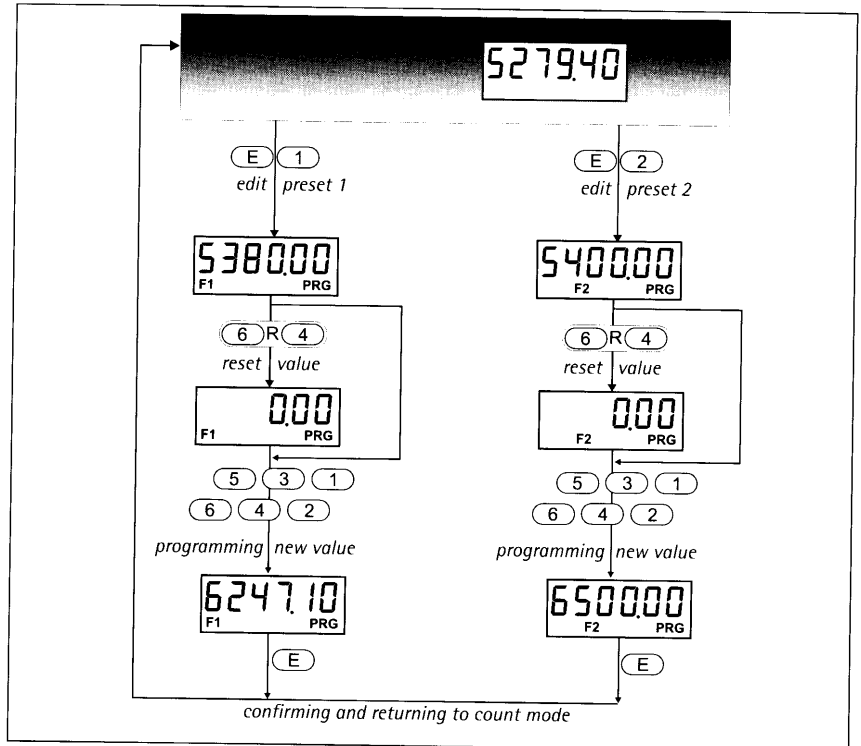

Hint:

If the new value is not confirmed by pressing the E-key, the return to the count mode will be done automatically after 15 sec without storing the new

2-Shift Counter

5. 2-Shift Counter type

5.1 Function

The basic function 3 is designed as 2-shift counter (for setting the basic function of multifunctional counter 0 732 0xx, see chapter 1.4).

A 2-shift counter makes the recording of 2 separate subtotals possible. Count input A affects subtotal 1 and count input B affects subtotal 2.

The pulse evaluation, which can be set under function code F1 of the shift counter, features the following options:

1. Add count input A, add count input B, count input C reset
2. Add count input A, subtract count input B, count input C reset

Both subtotals are separately counted positive. The total sum is calculated. It corresponds to the totalized sum / difference of the subtotals. The total sum does not change if one of the two subtotals is reset.

5.2 Programming of functionscodes

Programming mode:

press while switching **(E) (5)** Power on

Change parameter:

press **(1)**

Change to the next function:

press **(E)**

Return to count mode:

press > 5 sec **(E)**

F0	0	PRG
F1	0	PRG
F3	0	PRG
F10	1	PRG
F11	1	PRG
F12	0	PRG
F20	0	PRG
F21	0	PRG
F22	0	PRG
F23	0	PRG
F29	0	PRG

function	code	alternatives/signification
basic settings	F0	0* no function
		1 all function codes are set to the *-marked values
Shift-counter mode	F1	0* <u>Input A</u> adding <u>Input B</u> adding <u>Input C</u> reset
		1 adding subtracting reset
resolution	F3	0* no decimal point
		1 one decimal place (xxxx.x); 0.1 time unit
		2 two decimal places (xxx.xx); 0.01 time unit
		3 three decimal places (xxx.xxx); 0.001 time unit
pnp/npn-selection	F10	0 npn
		1* npn
input attenuation	F11	0 30 Hz attenuation (for contacts)
		1* no attenuation, 5 kHz (bidirectional counting: 2,5 kHz)
dyn./static Reset	F12	0* static reset
		1 dynamic reset (counting possible during resetting)
keylock for reset key 6+4	F20	0* key reset is possible
		1 key reset is not possible (or possible with delay see F29)
reserved	F21	0* without
		1 without
reserved	F22	0* without
		1 without
keylock for prescaler	F23	0* access to prescaler is possible
		1 access to prescaler is not possible (or delayed see F29)
keylock mode for (F20-F23)	F29	0* access to parameters from F20-F23 is possible after holding the keys for more than 10 sec.
		1 access to parameter is not possible

* default values

2-Shift counter

5.3 Switching the display

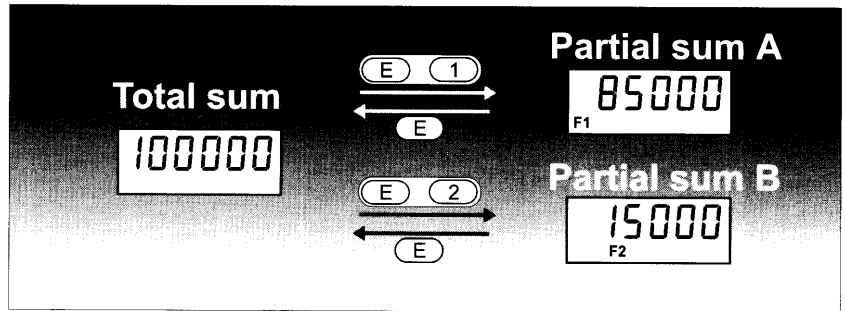

5.4 Reset the partial sums

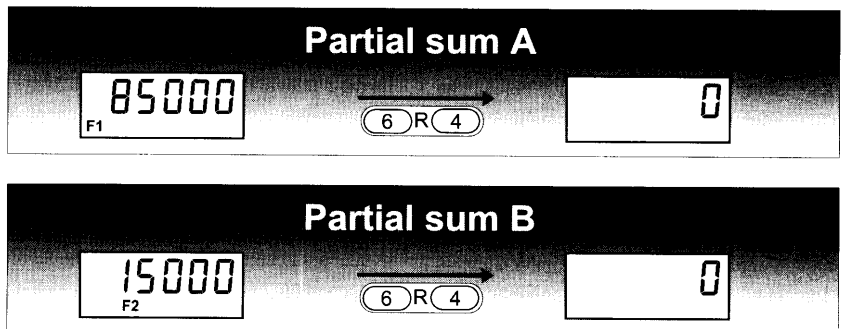

- Deleting the subtotals is possible only via the keypad. The value of the total sum is not affected by deleting one or both subtotals.
- Deleting the total sum is possible only via the reset input (input C), whereby the subtotals are deleted, too.

Comments:

If individual counts are separately deleted, the value of the total sum does not correspond any longer to the sum or difference of the individual values! An overflow of an individual sum is thus possible although the total sum has not yet reached its maximum value.

With the totalizing counter via keypad, there is only a dynamic reset.

With a reset via input C, a static reset is possible, too (see function code F12).

5.5 Programming of Prescaler

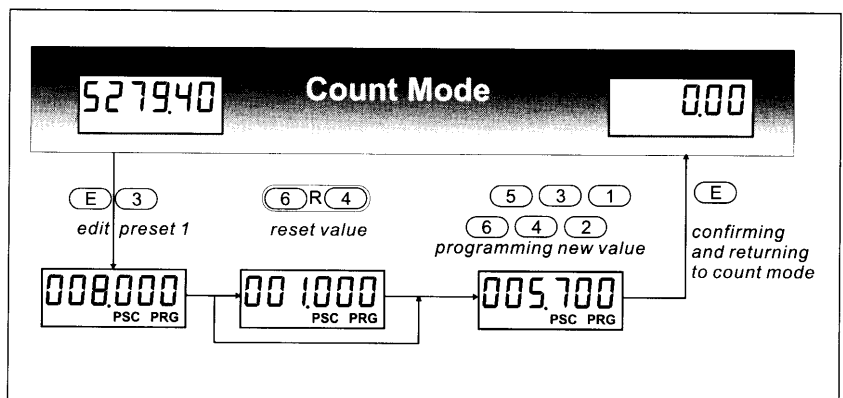

Hint:

If the new value is not confirmed by pressing the E-key, the return to the count mode will be done automatically after 15 sec without storing the new value.

Batch counter

6. Batch counter type

6.1 Function

Example

The basic function 4 is designed as batch counter (for setting the basic function of multifunctional counter 0 732 0xx, see chapter 1.4).

As a rule, the batch counter has 2 presets. VW1 is the batch preset, VW2 is the main preset.

If preset 2 (main preset) is active, the batch counter is increased by 1. The batch counter is displayed with <E+4>. When the batch preset is reached, output 1 is set.

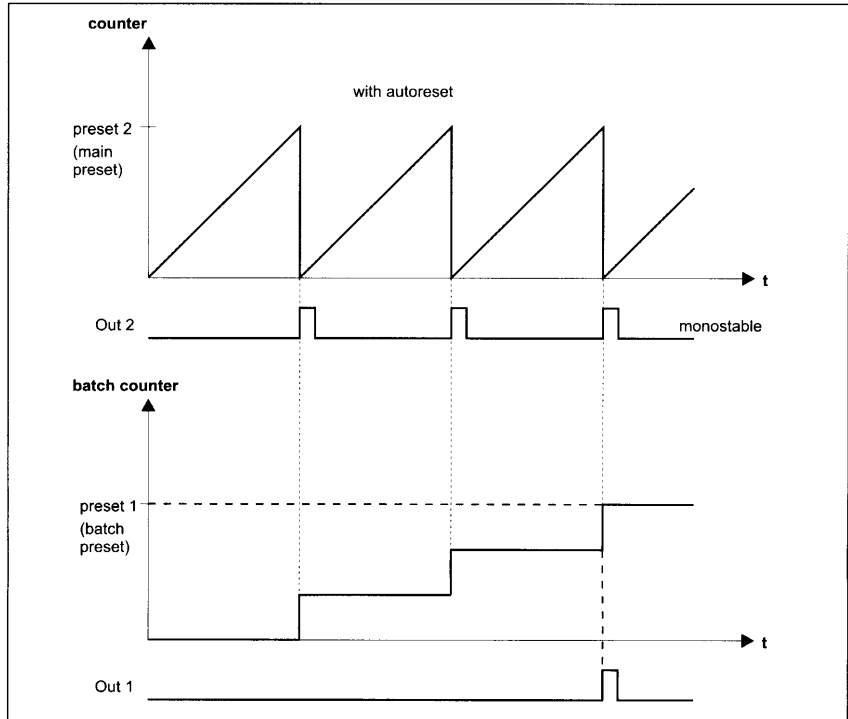

A batch counter has 2 control functions. Preset 2 is used as main preset (e.g. 5 peaces per box) while preset 1 is used as batch preset (e.g. 30 boxes per pallet).

6.2 Programming of functionscodes

Programming mode:
 press while switching **(E) (5)**
 Power on

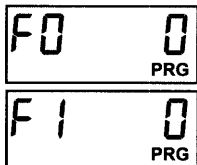

Change parameter:

press **(1)**

Change to the next function:

press **(E)**

Return to count mode:

press > 5 sec **(E)**

function	code	alternatives/signification		
basic settings	F0	0*	no function	
		1	all function codes are set to the *-marked values	
count mode	F1	0*	Input A	Input B
		1	count Input	gate
		2	count Input	direction(u/d)
		3	count Input	direction(u/d)
		4	adding	subtracting
		5	adding	subtracting
		6	adding	adding
		7	channel A ¹	channel B ¹
			reset	reset
			gate	gate

*default values

¹ bidirectional counting with single evaluation (eg. for encoders with 2 channels A,B)

Batch counter

F3 0
PRG

F4 0
PRG

F6 0.10
PRG

F7 0.10
PRG

F9 0
PRG

F10 1
PRG

F11 1
PRG

F12 0
PRG

F14 0
PRG

F20 0
PRG

F21 0
PRG

F22 0
PRG

F23 0
PRG

F29 0
PRG

function	code	alternatives/signification	
decimal point (on display)	F3	0*	no decimal point
		1	one decimal place (xxxx.x
		2	two decimal places (xxxx.xx)
		3	three decimal places (xxx.xxx)
reset/setmode	F4	0*	reset to „0“, no autoreset
		1	reset to „0“, with autoreset when reaching preset 2
		2	set to preset 2, no autoreset
		3	set to preset 2, with autoreset when reaching „0“
signal time output 1	F6 ²	OFF	no Output signal
		On	bistable Output signal, will be deleted by Out 2
		0,02	20 ms
		0,05	50 ms
		0,10*	100 ms
		0,20	200 ms
		0,50	500 ms
		1,00	1 s
signal time output 2	F7 ²	see above	see above; signal time output 1 above
Output in case of reset	F9	0*	Output from main preset (OUT 2) ³ is not activated by reset
		1	Output from main preset (OUT 2) ³ is activated by reset
pnp/npn-selection	F10	0	nnp
		1*	pnp
input attenuation	F11	0	30 Hz attenuation (for contacts)
		1*	no attenuation, 5 kHz (bidirectional counting: 2,5 kHz)
dyn./static Reset	F12	0*	static reset
		1	dynamic reset (counting possible during resetting)
output signal memory	F14	0*	after power fail, the signal times will not be restarted
		1	after power fail, the signal times will be restarted
keylock for reset key 6+4	F20	0*	key reset is possible
		1	key reset is not possible (or possible with delay see F29)
keylock for preset 1	F21 ²	0*	access to preset 1 is possible
		1	access to preset 1 is not possible (or delayed see F29)
keylock for preset 2	F22 ²	0*	access to preset 2 is possible
		1	access to preset 2 is not possible (or delayed see F29)
keylock for prescaler	F23	0*	access to prescaler is possible
		1	access to prescaler is not possible (or delayed see F29)
keylock mode for (F20-F23)	F29	0*	access to parameters from F20-F23 is possible after holding the keys for more than 10 sec.
		1	access to parameter is not possible

* default values

² parameter only appears for preset version

³ with appliances with one preset only, this applies to preset 1 and output 1 (OUT 1)

Batch counter

6.3 Switching the display

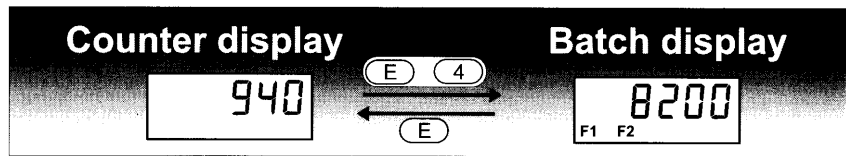

6.4 Reset the display

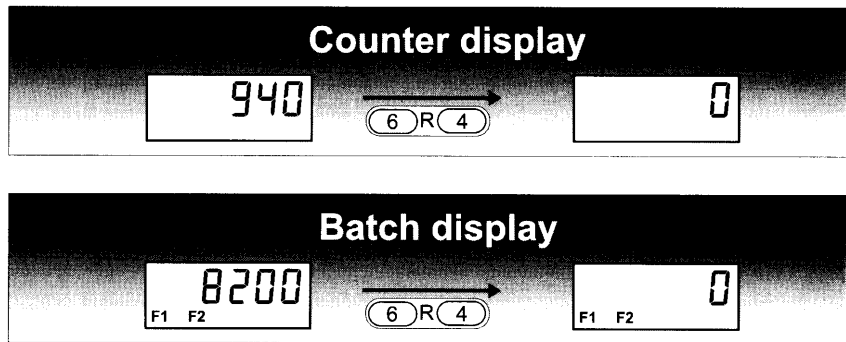

- The count can be reset both via the keypad and via the reset input (input C).
- The batch count can only be reset via the keypad.

6.5 Programming of Presets and Prescaler

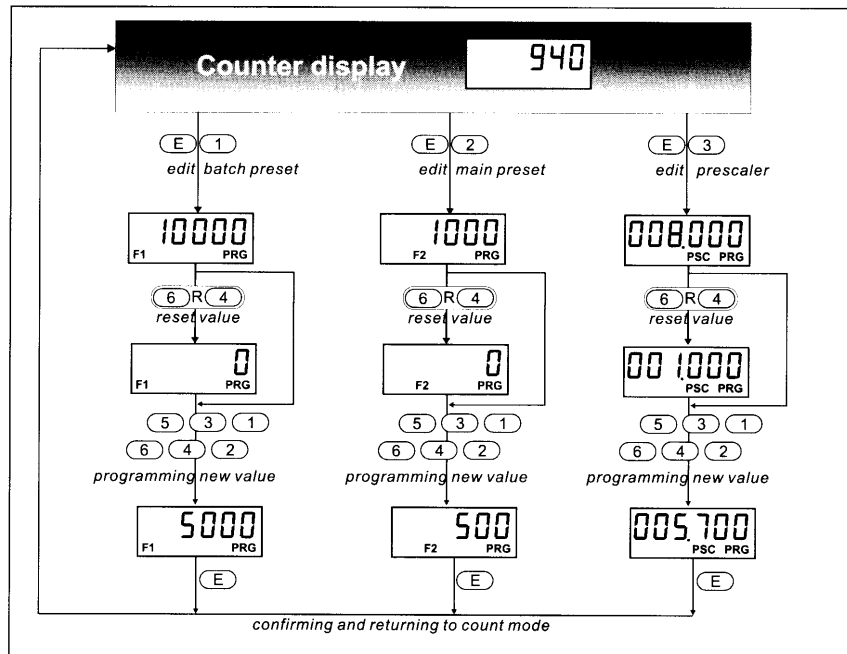

Hint:

If the new value is not confirmed by pressing the E-key, the return to the count mode will be done automatically after 15 sec without storing the new

General

7. Specifications

	Display	LED or LCD, 6 digits, leading zero suppression, decimal point
	Digit height	LED 7,6 mm; LCD 9 mm
	Supply voltage	12...24 VDC or 24 VAC; 100 VAC; 115 VAC; 230 VAC; 50/60 Hz
	Tolerances	± 10%
	Current consumption	12...24 VDC < 150 mA 100/115/230 VAC < 50 mA; including sensor supply
	Overload protection	ext. fuse DC: 0,16 AT/IEC 127 DC: 0,2 AT/UL 198 230 VAC: 32 mA; 115/100 VAC: 63 mA
	Sensor supply	only when AC operated: 12...30 VDC, max 50 mA
	Data retention	non-volatile memory > 10 years
	Electrical connection	screw terminals
	Mounting	with clamping frame, panel thickness max. 11mm
	Amplitude thresholds	< 2 V and > 8 V, max 40 VDC
	Active edge	programmable; positive with pnp input; negative with npn input
	Pulse shape	any (squarewave 1:1 for max. frequency)
	Input resistance	approx. 10 kOhm (static)
	Counting frequency	max. 5 kHz (2.0 kHz bi-directional); with the accessory totalizer switched on, the count frequency is diminished by approx. 10%
	Prescaler	programmable from 0,001 to 999,999
Counter, Batch counter, 2-Shift counter	Count inputs A, B	- phase discriminator with single evaluation - differential mode (add/sub) - count direction mode - totalizing mode (add/add)
	Pulse length min. Control Input C	17 ms (30 Hz), 100 µs (5 kHz) - manual reset possible - external reset, static or dynamic, programmable, pulse length > 5 ms - automatic reset when main preset has been reached (programmable)
	Relay	changeover contact max. 250 VAC / 30 VDC, min. 5 V max. 1 A, min. 10 mA, delay < 5 ms
	Transistor	pnp output 12...24 VDC; max 10 mA with DC supply 12...30 VDC; max 10 mA with AC supply
Tachometer	Count mode	period measurement
	Response time	Display and outputs are checked every 500 ms (f>2 Hz); If f<2 Hz, there is an update at the end of each period
	Alarms	2 alarms with programmable start-up-suppression
Time-counter	Time bases	programmable; sec, min., h or in display format HH:MM:SS
	Resolution	programmable 1; 0,1; 0,01; 0,001
	Function	single pulse measurement (short time meter) or cumulated counting (hour meter)
	count mode	pulse width or period measurement (start-stop)
Ambient Conditions / Safety Regulations	Operating Temperature	0°C ... 50 °C
	Storage Temperature	- 20 °C ... + 60°C
	Protection Class	front side IP 65 (EN 60529)
	Vibro stability	10 m/s ² (10...150 Hz) according to IEC 68-part 2-6
	Shock stability	100 m/s ² (18 ms) according to IEC 68- part 2-27
	General Rating	according VDE 0411, DIN 57411, EN 61010, protection class II
	Climatic Standards	DIN 40 040: 40/92 °C/% relative air humidity; KWF
	Contamination level	2, according to VDE 0110
EMC-Noise immunity	EN 50082-2	
EMC-Emission	EN 50081-2	

General

8. Ordering code

Article No.: 0 732 **A B**

Suffix A Function

0	Multifunction
1	Counter
2	Tachometer
3	Time counter

Suffix B	Display	Presets	Supply
00	LCD	no	12 – 24 VDC
01	LCD	no	230 VAC
37	LCD	no	115 VAC
71	LCD	no	24 VAC
02	LCD	1 preset ¹	12 – 24 VDC
03	LCD	1 preset ¹	230 VAC
39	LCD	1 preset ¹	115 VAC
73	LCD	1 preset ¹	24 VAC
12	LCD	2 presets	12 – 24 VDC
13	LCD	2 presets	230 VAC
49	LCD	2 presets	115 VAC
78	LCD	2 presets	24 VAC
18	LED	no	12 – 24 VDC
19	LED	no	230 VAC
55	LED	no	115 VAC
80	LED	no	24 VAC
20	LED	1 preset ¹	12 – 24 VDC
21	LED	1 preset ¹	230 VAC
57	LED	1 preset ¹	115 VAC
82	LED	1 preset ¹	24 VAC
30	LED	2, presets	12 – 24 VDC
31	LED	2 presets	230 VAC
67	LED	2 presets	115 VAC
87	LED	2 presets	24 VAC

¹ not for tachometers

² please inquire for 100 VAC version

Accessories: adapter frame for panel mounting:
for cut-out 50x50, part No. 1 405 675
for cut-out 72x72, part No. 1 405 676

Further accessories see Counter Catalogue

HENGSTLER INTERNATIONAL

GROUP MEMBERS

- **Germany**
Hengstler GmbH
Postfach 1151
78550 Aldingen
Tel. (0 74 24) 8 90
Fax (0 74 24) 8 94 70/8 93 70
- Hengstler GmbH
Geschäftsbereich Bauelemente
Postfach 1249
78561 Wehingen
Tel. (0 74 26) 68-0
Fax (0 74 26) 6 82 81
- **Canada**
Hengstler Canada Inc.
151 Brunel Road
Units 34-35
Mississauga, Ontario L4Z 2H6
Tel. (905) 5078893
Fax (905) 5079496
- **France**
Hengstler Contrôle Numérique
S.A.R.L.
Z.I. des Mardelles
94-106, Rue Blaise Pascal, B.P. 71
93602 Aulnay-sous-Bois, Cédex
Tel. (01) 48795500
Fax (01) 48795569

- **Italy**
Hengstler Italia S.r.l.
Div. Prodotti Industriali
Via G. Cavalcanti, 5
20127 Milano MI
Tel. (02) 26821943
Fax (02) 26821953
- **Japan**
Hengstler Japan Corp.
8-5, Asagaya Minami 1-Chome
Suginami-Ku
Tokyo 166
Tel. (03) 53060150
Fax (03) 53060160
- Hengstler Japan Corp.
12-23, Minamikaneden 2-Chome
Suita-shi
Osaka 564
Tel. (06) 3868001
Fax (06) 3865022
- **Spain**
Hengstler España S.A.
C/Córcega, 541, 2º 1º
08025 Barcelona
Tel. (03) 435.51.50 / 64.28 / 76.92
Fax (03) 347.92.60

AGENTS

- Argentina
- Australia
- Austria
- Belgium
- Bulgaria
- Brazil
- Chile
- China
- CIS
- Colombia
- Czech. Republic
- Denmark
- Egypt
- Finland
- Greece
- Hong-Kong
- Hungary
- India
- Iran
- Ireland
- Israel
- Kenya
- Lebanon
- Mexico
- Netherlands
- New Zealand
- Norway
- Pakistan
- Peru
- Philippines
- Poland
- Portugal
- Romania
- Singapore
- Slovenia
- Slovac. Republic
- South Africa
- Spain
- Sweden
- Switzerland
- Taiwan
- Thailand
- Turkey
- USA
- Venezuela

© 1996 HENGSTLER GmbH HENGSTLER GmbH claims the copyright for this documentation.
Technical data subject to alterations.

This documentation may not be changed, amended, or copied without prior written consent of HENGSTLER GmbH, and may not be used in contradiction to this company's rightful interests.

HENGSTLER

Hengstler GmbH
Postfach 11 51
D-78550 Aldingen
Germany
Tel. +49-7424-89 517
Fax +49-7424-89 370



Member of the **DANAHER CORPORATION** U.S.A.