



H-Frame



J-Frame



L-Frame



M-Frame



P-Frame

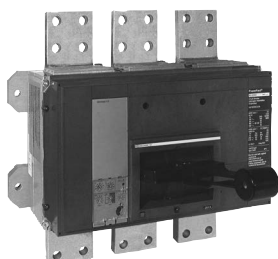

R-Frame

Description	Page
Selection Information	DE3-2
QO™ and QOU Miniature Circuit Breakers	DE3-10
QO™ Miniature Circuit Breakers	DE3-10
QO™ Circuit Breaker Accessories	DE3-12
QO™ and Multi 9™ Mounting Bases	DE3-13
QOU Miniature Circuit Breakers	DE3-14
QOU Accessories	DE3-15
Multi 9™ Miniature Circuit Breakers	DE3-16
PowerPact™ Molded Case Circuit Breakers	DE3-21
PowerPact Family	DE3-21
H- and J-Frame Circuit Breakers	DE3-22
Q-Frame Circuit Breakers	DE3-24
L-Frame Circuit Breakers	DE3-25
M-Frame Circuit Breakers	DE3-26
P-Frame Circuit Breakers	DE3-27
R-Frame Circuit Breakers	DE3-28
Motor Circuit Protectors	DE3-29
PowerPact™ H- and J-Frame Electronic Motor Circuit Protectors	DE3-29
H-Frame and J-Frame MCP Selector	DE3-30
Motor Circuit Protectors and Motor Protector Circuit Breakers	DE3-31
H-, J-, and L-Frame MCP Selection	DE3-32
Motor Protection Selection Tables	DE3-33
Automatic Switches	DE3-34
500 Vdc Circuit Breakers	DE3-35
Mission Critical Circuit Breakers	DE3-37
PowerPact™ Circuit Breaker Accessories	DE3-39
Micrologic™ Electronic Trip Units	DE3-46
Masterpact™ Universal Power Circuit Breakers	DE3-50
Ground-Fault Protection	DE3-51
Dimensions and Shipping Weights	DE3-54
Circuit Breaker Enclosures	DE3-56
Photovoltaic Circuit Breakers and Switches	DE3-59
Molded Case Circuit Breakers	DE3-63
F-Frame Circuit Breakers	DE3-63
L-Frame Circuit Breakers	DE3-64
CDP connector kits	DE3-65

Selection Information





Miniature Circuit Breakers

Class 500, 600

DE3 CIRCUIT BREAKERS

		CHOM Circuit Breakers							QO™ Circuit Breakers																						
Circuit Breaker Type	Plug-on	CHOM	CHOM-AFI	CHOM-GFI	CHOM-EPD	CHOMT	QO	QO-H	QO-VH	QO-VH	QH	QOT	QO-CAFI	QO-VHAFI	QO-GFI	QO-VHGFI	QO-EPD QO-EPE	QOB	QOB-H	QOB-VH	QHB	QOB-CAFI	QOB-VHAFI	QOB-GFI	QOB-VHGFI	QOB-EPD QOB-EPE					
	Bolt-on	—	—	—	—	—	—	—	—	—	—	—	—	—	—	—	—	—	—	—	—	—	—	—	—						
	Unit Mount	—	—	—	—	—	—	—	—	—	—	—	—	—	—	—	—	—	—	—	—	—	—	—	—						
Number of Poles		1 2	1 2	1 2	1 2	1	1 2 3	2	1 2 3	1 2 3	1,2 3	1	1	1 2 3	1 2 3	1 2 3	1 2 3	1 2 3	1 2 3	1 2 3	1 2 3	1 2 3	1 2 3	1 2 3							
Current Range		15-60	15-200 [Ⓞ]	15-20	15-20	15-50	15-20	15-50	15-50	10-70	10-200 [Ⓞ]	10-100	15-100	15-30	15-125	15-100	15-30	15-30	15-30	15-30	15-20	15-30	15-30	15-60	15-50	15-30	15-30	15-60	15-50		
Interrupting Ratings																															
UL/CSA Rating (kA) (50/60 Hz)	120 Vac	10	10	10	10	10	10	10	10	10	10	10	10	22	22	22	22	22	65	65	10	10	22	10	10	—	22	10	10	—	
	120/240 Vac	10	10	—	—	10	—	10	10	10	10	10	10	22	22	22	22	22	65	65	10	—	—	—	10	—	—	—	10	—	
	208Y/120	—	—	—	—	—	—	—	—	—	—	—	—	—	—	—	—	—	—	—	—	—	—	—	—	—	—	—	—	—	
	240 Vac ★	—	—	—	—	—	—	—	—	—	—	10	10	—	—	—	—	—	—	—	—	—	—	—	—	—	—	—	—	—	10
	277 Vac	—	—	—	—	—	—	—	—	—	—	—	—	—	—	—	—	—	—	—	—	—	—	—	—	—	—	—	—	—	—
DC Ratings	48 Vdc	—	—	—	—	—	—	—	—	5▼	5▼	5▼	—	—	—	—	—	—	—	—	—	—	—	—	—	—	—	—	—	—	
	60 Vdc	—	—	—	—	—	—	—	—	—	—	—	—	—	—	—	—	—	—	—	—	—	—	—	—	—	—	—	—	—	
	65 Vdc	—	—	—	—	—	—	—	—	—	—	—	—	—	—	—	—	—	—	—	—	—	—	—	—	—	—	—	—	—	
	125 Vdc	—	—	—	—	—	—	—	—	—	—	—	—	—	—	—	—	—	—	—	—	—	—	—	—	—	—	—	—	—	
	250 Vdc	—	—	—	—	—	—	—	—	—	—	—	—	—	—	—	—	—	—	—	—	—	—	—	—	—	—	—	—	—	
IEC 60947-2 (50/60 Hz) ▼	IEC (Icu)	—	—	—	—	—	—	—	—	—	—	—	—	—	—	—	—	—	—	—	—	—	—	—	—	—	—	—	—	—	
Special Ratings																															
CCC	—	—	—	—	—	—	—	—	—	—	—	—	—	—	—	—	—	—	—	—	—	—	—	—	—	—	—	—	—	—	
Fed. Specs W-C-375B/GEN	X	X	X	X	X	X	X	X	X	X	—	—	—	X	—	—	—	—	X	—	X	X	—	X	—	—	—	X	—	—	
Other Standard	HACR ▲	NOM	—	—	—	—	—	—	—	HACR □	NOM	—	—	—	—	—	—	—	—	—	—	HACR □	—	NOM	—	—	—	NOM	—	—	
Accessories and Modifications																															
Shunt Trip ◊	—	—	—	—	—	—	—	—	—	X	X	X	X	X	X	X	X	X	X	X	X	X	X	X	X	X	X	X	X	X	
Undervoltage Trip	—	—	—	—	—	—	—	—	—	—	—	—	—	—	—	—	—	—	—	—	—	—	—	—	—	—	—	—	—	—	
Auxiliary Switches ◊	—	—	—	—	—	—	—	—	—	X	X	X	X	X	X	X	X	X	X	X	X	X	X	X	X	X	X	X	X	X	
Alarm Switch ◊	—	—	—	—	—	—	—	—	—	X	X	X	X	X	X	X	X	X	X	X	X	X	X	X	X	X	X	X	X	X	
Handle Operators	—	—	—	—	—	—	—	—	—	—	—	—	—	—	—	—	—	—	—	—	—	—	—	—	—	—	—	—	—	—	
Handle Padlock Attachment	X	X	X	—	—	—	—	X ▼	X	X	X	X	X	X	X	X	X	X	X	X	X	X	X	X	X	X	X	X	X	X	
Trip System Type																															
Thermal-magnetic	X	X	X	X	X	X	X	X	X	X	X	X	X	X	X	X	X	X	X	X	X	X	X	X	X	X	X	X	X	X	
Molded Case Switch	—	—	—	—	—	—	—	—	—	X	X	X	—	—	—	—	—	—	—	—	—	—	—	—	—	—	—	—	—	—	
Dimensions (1P Unit Mount)																															
Dimensions (1P Unit Mount) in. (mm)	Height	3.13 (79)							3.5 (89) ▲							4.75 (121)				4.12 (103)											
	Width	1.00 (25)							—							0.75 (19) ▲				—											
	Depth	2.98 (76)							—							—				2.92 (74) ▲											
Pages	Section DE1														Pages DE3-10, DE3-11																

- ▲ See page DE3-54 for dimensions for: QOB2150VH, QOB3110VH, QOB3125VH and QOB3150VH.
- CHOMT tandem is 30 A maximum. CHOMT quad has 20 A maximum on outside poles, and 50 A maximum on the inside poles.
- ◆ AFI, EPD and GFI products are rated 60 Hz only.
- ★ 22 kA @ 240 Vac for 3P only.
- ▼ 1P and 2P, 10-70 A and 3P 10-60 A only.
- HACR on CHOM 1P 15-50 A and 2P 15-100 A
- △ HACR on QO, QOB 1P 10-70 A, 2P 15-100 A, 3P 10-100 A; QOB-VH 1P 15-70 A, 2P 15-125 A, 3P 15-100 A.
- ◊ Factory-installed option only.
- ☆ Factory-installed accessories are not available on QOB-VH 2P150 A and 3P 110-150 A.
- ▽ Handle padlock attachment available for CHOMT quad tandem only.
- Ⓞ 2P 150-200 A requires 4P width.

		QOU Circuit Breakers			QOM1 and QOM2 Main Circuit Breakers		Multi 9™ Circuit Breakers and Supplementary Protectors						EDB Circuit Breakers							
																				
Circuit Breaker Type	Plug-on	—			—		—			—			—		—		—			
	Bolt-on	—			QOM1-VH	QOM2-VH	—			—			EDB		EGB		EJB			
	Unit Mount	QOU			—		CSA C22.2 No. 5/UL 489 C60			CSA C22.2 No. 235/UL1077 C60			C60H-DC▲		—		—			
Number of Poles		1	2	3	2	2	1	2	3	1	2	3,4	1	2	1	2,3	1	2,3	1	2,3
Current Range		10-100	10-125	10-100	50-125	100-225	0.5-35	0.5-35	0.5-35	0.5-63	1-63	1-63	0.5-40	0.5-40	15-70	15-125☆	15-70	15-125☆	15-70	15-125☆
Interrupting Ratings																				
UL/CSA Rating (kA RMS) (50/60 Hz)	120 Vac	10	10	10	22	22	10	—	—	10	10	10	—	—	25	25	65	65	100	100
	120/240 Vac	10	10	10	22	22	5	10	10	10	10	10	—	—	18	25	35	65	65	100
	240 Vac	—	—	10	—	—	5	10	10	10	10	10	—	—	18	25	35	65	65	100
	277 Vac	—	—	—	—	—	—	—	—	5	5	5	—	—	18	18	35	35	65	65
	377 Vac	—	—	—	—	—	—	—	—	—	—	—	—	—	14	—	18	—	25	—
	480Y/277 Vac	—	—	—	—	—	10	10	10	—	5	5	—	—	—	18	—	35	—	65
600Y/347 Vac	—	—	—	—	—	—	—	—	—	—	—	—	—	—	14	—	18	—	25	
DC Ratings	48 Vdc	5■	5■	5■	—	—	—	—	—	10	10	—	5	5	—	—	—	—	—	—
	60 Vdc	5♦	5♦	5♦	—	—	10	10	—	—	—	—	5	5	—	—	—	—	—	
	65 Vdc	—	—	—	—	—	—	—	—	10	10	—	5	5	—	—	—	—	—	
	125 Vdc	—	—	—	—	—	—	10	—	—	10	—	5	5	—	—	—	—	—	
	250 Vdc	—	—	—	—	—	—	—	—	—	—	—	5	5	—	—	—	—	—	
	500 Vdc	—	—	—	—	—	—	—	—	—	—	—	—	5	—	—	—	—	—	
IEC 60947-2 (50/60 Hz) Icu	240 Vac	—	—	—	—	—	20	20	20	10	10	10	20	10	20	—	—	—	—	
	415 Vac	—	—	—	—	—	—	10	10	—	5	5	—	—	10	—	—	—		
Special Ratings																				
CCC		X◇	X◇	X◇	—	—	—	—	—	—	—	—	—	—	—	—	—	—	—	
Fed. Specs W-C-375B/GEN		X	X	X	X	X	X	X	—	—	—	—	—	—	X	X	X	X	X	
Other Standard		HACR ★			—	—	—	—	—	—	—	—	—	—	HACR					
Accessories and Modifications																				
Shunt Trip		X▼	X▼	X▼	—	X▼	X	X	X	X	X	X	X	X	X▼	X▼	X▼	X▼	X▼	
Undervoltage Trip		—	—	—	—	—	X	X	X	X	X	X	X	X	—	—	—	—		
Auxiliary Switches		X▼	X▼	X▼	—	—	X	X	X	X	X	X	X	X	X▼	X▼	X▼	X▼	X▼	
Alarm Switch		X▼	X▼	X▼	—	—	X	X	X	X	X	X	X	X	X▼	X▼	X▼	X▼	X▼	
Handle Operators		—	—	—	—	—	X	X	X	X	X	X	X	X	—	—	—	—		
Handle Padlock Attachment		X	X	X	X	X	X	X	X	X	X	X	X	X	X	X	X	X	X	
Trip System Type																				
Thermal-magnetic		X	X	X	X	X	X	X	X	X	X	X	X	X	X	X	X	X	X	
Molded Case Switch		—	X	X	—	—	—	—	—	—	—	—	—	—	—	—	—	—		
Dimensions (1P Unit Mount)																				
Dimensions (1P Unit Mount) in. (mm)	Height	4.05 (103)			5.09 (129)△		5.60 (142)△			4.21 (107)□			3.19 (81)		3.19 (81)		5.66 (144)			
	Width	0.75 (19)			5.00 (127)△		5.07 (129)△			0.71 (18)			0.71 (18)		0.71 (18) 1.42 (36)		0.98 (25)			
	Depth	2.92 (74)			3.47 (88)△		3.60 (91)△			2.76 (70)			2.76 (70)		2.56 (65)		4.05 (103)			
Pages		Pages DE3-14			Section DE1			Pages DE3-16 through DE3-19						Section DE5						

Note: All circuit breakers on this chart are UL Listed and CSA Certified unless otherwise noted.

- ▲ C60H-DC is a UL 1077 (not CSA certified) supplementary protector.
- 1P and 2P, 10-70 A and 3P 10-60 A only.
- ♦ QOU is CSA/UL Listed for 60 Vdc per pole 80-100 A, 1P; 80-125 A, 2P; and 70-100 A, 3P.
- ★ HACR on QOU 1P and 3P 15-100 A, 2P 15-125 A;
- ▼ Factory-installed option only
- △ QOM1 and QOM2 dimensions are for 2-pole unit.
- 480 V C60 height is 5.56 in. (141 mm).
- ◇ 15-70 A 1P and 2P, 15-60 A 3P.
- ☆ 110 A maximum at 600Y/347 Vac



DE3 CIRCUIT BREAKERS

Selection Information

Molded Case Circuit Breakers

Class 500, 600, 800

DE3 CIRCUIT BREAKERS

	PowerPact™ 150 A H-Frame					PowerPact 250 A J-Frame					
											
Circuit Breaker Type	HD	HG	HJ	HL	HR	JD	JG	JJ	JL	JR	
Number of Poles	2, 3	2, 3	2, 3▲	2, 3▲	3	2, 3▲	2, 3▲	2, 3▲	2, 3▲	3	
Current Range	15–150 A	15–150 A	15–150 A	15–150 A	15–150 A	70–250 A■	70–250 A■	70–250 A■	70–250 A■	70–250 A■	
Interrupting Ratings											
UL/CSA/NOM Rating (kA RMS) (50/60 Hz)	240 Vac	25	65	100	125	200	25	65	100	125	200
	480Y/277 Vac	18	35	65	100	200	18	35	65	100	200
	480 Vac	18	35	65	100	200	18	35	65	100	200
	600Y/347 Vac	14	18	25	50	100	14	18	25	50	100
	600 Vac	14	18	25	50	100	14	18	25	50	100
DC Ratings	250 Vdc◆	20	20	20	20	—	20	20	20	20	—
	500 Vdc◆	—	—	—	—	—	—	20	—	—	—
IEC Rating (kA RMS) Icu/Ics★	240 Vac	25/25	65/65	100/100	125/125	125/125	25/25	65/65	100/100	125/125	125/125
	415 Vac	18/18	35/35	65/65	100/100	100/100	18/18	35/35	65/65	100/100	100/100
Special Ratings											
CCC	X	X	X	X	X	X	X	X	X	X	
Fed. Specs W-C-375B/GEN	X	X	X	X	X	X	X	X	X	X	
HACR (2P, 3P)	X	X	X	X	X	X	X	X	X	X	
Connections/Terminations											
Unit Mount	X	X	X	X	X	X	X	X	X	X	
I-Line™	X	X	X	X	X	X	X	X	X	X	
Rear Connection	X▼	X▼	X	X	X	X	X	X	X	X	
Drawout	X▼	X▼	X	X	X	X	X	X	X	X	
Optional Lugs	X▼	X▼	X	X	X	X	X	X	X	X	
Accessories and Modifications											
Shunt Trip	X	X	X	X	X	X	X	X	X	X	
Undervoltage Trip	X	X	X	X	X	X	X	X	X	X	
Auxiliary Switches	X	X	X	X	X	X	X	X	X	X	
Alarm Switch	X	X	X	X	X	X	X	X	X	X	
Motor Operator	X▼	X▼	X	X	X	X	X	X	X	X	
Handle Operators	X▼	X▼	X	X	X	X	X	X	X	X	
Mechanical Interlocks (3P)	X	X	X	X	X	X	X	X	X	X	
Handle Padlock Attachment	X▼	X▼	X	X	X	X	X	X	X	X	
Cylinder Lock (3P)	—	—	—	—	—	—	—	—	—	—	
Optional GF Protection	—	—	—	—	—	—	—	—	—	—	
Trip System Type											
Thermal-magnetic	X	X	X	X	—	X	X	X	X	X	
Instantaneous-only (MCP)	—	—	X△	X△	X△	—	X△	X△	X	X	
Molded Case Switch (Automatic)	X	X	X	X	X	X	X	X	X	X	
Electronic	X△	X△	X△	X△	X△	X△	X△	X△	X△	X△	
Enclosures (Pages DE3-56–DE3-58)											
General Purpose (NEMA 1)	X	X	X	X	—	X	X	X	—	—	
Raintight (NEMA 3R)	X	X	X	X	—	X	X	X	—	—	
Dust-tight (NEMA 12)	X	X	X	X	—	X	X	X	—	—	
Watertight (NEMA 4, 4X, 5)	X	X	X	X	—	X	X	X	—	—	
Explosion Proof (NEMA 7, 9)	—	—	—	—	—	—	—	—	—	—	
Dimensions (3P Unit Mount) in. (mm)	Height	6.4 (163)					7.5 (191)				
	Width	4.1 (104)					4.1 (104)				
	Depth	3.4 (86)					3.4 (86)				
Pages (Unit Mount)/(I-Line)	Pages DE3-22, DE3-23, DE3-29, DE3-34/Section DE5					Pages DE3-22, DE3-23, DE3-29, DE3-34, DE3-35/Section DE5					

Note: All circuit breakers on this chart are UL Listed and CSA Certified unless otherwise noted.

- ▲ 2P in a 3P module.
- 70–250 A with electronic trip system
- ◆ Not available with electronic trip units
- ★ Dual CSA/UL and IEC ratings and CE markings on circuit breakers.
- ▼ Not available in HD and HG 2P rating (2P module).
- △ 3P only.

Selection Information

Molded Case Circuit Breakers

Class 500, 600, 800

		PowerPact 250 A Q-Frame				PowerPact 600 A L-Frame				
										
Circuit Breaker Type		QB	QD	QG	QJ	LD	LG	LJ	LL	LR
Number of Poles		2, 3	2, 3	2, 3	2, 3	3, 4	3, 4	3, 4	3, 4	3, 4
Current Range		70–250■	70–250■	70–250■	70–250■	70–600	70–600	70–600	70–600	70–600
Interrupting Ratings										
UL/CSA/NOM Rating (kA RMS) (50/60 Hz)	240 Vac	10	25	65	100	25	65	100	125	200
	480Y/277 Vac	—	—	—	—	18	35	65	100	200
	480 Vac	—	—	—	—	18	35	65	100	200
	600Y/347 Vac	—	—	—	—	14	18	25	50	100
DC Ratings	600 Vac	—	—	—	—	14	18	25	50	100
	250 Vdc★	—	—	—	—	—	—	—	—	—
IEC Rating (kA RMS) Icu/Ics★	500 Vdc◆★	—	—	—	—	—	—	—	—	—
	240 Vac	10/5	10/5	10/5	10/5	25/25	65/65	100/100	125/125	125/125
	415 Vac	10/5	10/5	10/5	10/5	18/18	35/35	65/65	100/100	100/100
Special Ratings										
CCC		—	—	—	—	X	X	X	X	X
Fed. Specs W-C-375B/GEN		X	X	X	X	—	—	—	—	—
HACR (2P, 3P)		X	X	X	—	X	X	X	X	X
Connections/Terminations										
Unit Mount		X	X	X	X	X	X	X	X	X
I-Line™		X	X	X	X	X	X	X	X	X
Rear Connection		—	—	—	—	X	X	X	X	X
Drawout		—	—	—	—	X	X	X	X	X
Optional Lugs		—	—	—	—	X	X	X	X	X
Accessories and Modifications										
Shunt Trip		—	—	—	—	X	X	X	X	X
Undervoltage Trip		—	—	—	—	X	X	X	X	X
Auxiliary Switches		—	—	—	—	X	X	X	X	X
Alarm Switch		—	—	—	—	X	X	X	X	X
Motor Operator		—	—	—	—	X	X	X	X	X
Handle Operators		—	—	—	—	X	X	X	X	X
Mechanical Interlocks (3P)		X	X	X	X	X	X	X	X	X
Handle Padlock Attachment		X	X	X	X	X	X	X	X	X
Cylinder Lock (3PΔ)		—	—	—	—	—	—	—	—	—
Optional GF Protection▼		—	—	—	—	X	X	X	X	X
Trip System Type										
Thermal-magnetic		X	X	X	X	—	—	—	—	—
Instantaneous-only (MCP)		—	—	—	—	X	X	X	X	X
Molded Case Switch (Automatic)		X	—	—	—	—	X	—	X	X
Electronic		—	—	—	—	X	X	X	X	X
Enclosures (Pages DE3-56–DE3-58)										
General Purpose (NEMA 1)		X	X	X	X	—	—	—	—	—
Raintight (NEMA 3R)		X	X	X	X	—	—	—	—	—
Dust-tight (NEMA 12)		—	—	—	—	—	—	—	—	—
Watertight (NEMA 4, 4X, 5)		—	—	—	—	—	—	—	—	—
Explosion Proof (NEMA 7, 9)		—	—	—	—	—	—	—	—	—
Dimensions (3P Unit Mount) in. (mm)	Height	6.47 (164)				13.38 (340)				
	Width	4.5 (114)				5.51 (140)				
	Depth	3.93 (100)				4.33 (110)				
Pages (Unit Mount)/(I-Line)		Pages DE3-24/Section DE5				Pages DE3-25/DE3-33				

Note: All circuit breakers on this chart are UL Listed and CSA Certified unless otherwise noted.

- ▲ 2P in a 3P module.
- I-Line Q-frame circuit breakers are available 70–225 A only. 250 A Q-frame unit-mount circuit breakers are limited to Cu conductors only.
- ◆ Ungrounded UPS systems only. See page DE3-35. Special DC J-Frame only.
- ★ Dual CSA/UL and IEC ratings and CE markings on circuit breakers.
- ▼ Requires factory-installed “G” shunt trip and 3P module.
- △ Factory-installed option only.
- 3P only.
- ◆ 70–250 A with electronic trip system.
- ☆ Not available with electronic trip units.

Selection Information

Molded Case Circuit Breakers



Class 600, 612, 800

DE3 CIRCUIT BREAKERS

	PowerPact 800 A M-Frame			PowerPact 1200 A P-Frame				PowerPact 3000 A R-Frame				
												
Circuit Breaker Type	MG	MJ		PG	PJ	PK	PL	RG	RJ	RK	RL	
Number of Poles	2, 3	2, 3		2, 3, 4	2, 3, 4	2, 3, 4	2, 3, 4	2, 3, 4	2, 3, 4	2, 3, 4	2, 3, 4	
Current Range	300–800	300–800		100–1200	100–1200	100–1200	100–1200	240–3000	240–3000	240–3000	240–3000	
Interrupting Ratings												
UL/CSA/NOM Rating (kA RMS) (50/60 Hz)	240 Vac	65	100	65	100	65	125	65	100	65	125	
	480Y/277 Vac	35	65	35	65	50	100	35	65	65	100	
	480 Vac	35	65	35	65	50	100	35	65	65	100	
	600Y/347 Vac	18	25	18	25	50	25	18	25	65	50	
DC Ratings	250 Vdc	—	—	—	—	—	—	—	—	—	—	
	500 Vdc▲	—	—	—	—	—	—	—	—	—	—	
IEC (kA RMS) Icu/Ics■	240 Vac	50/25	65/35	50/25	65/35	50/25	125/65	50/25	65/35	85/65	125/65	
	415 Vac	35/20	50/25	35/20	50/25	50/25	85/45	35/20	50/25	70/55	85/45	
Special Ratings												
CCC	X	X		X	X	X	X	X	X	X	X	
Fed. Specs W-C-375B/GEN	X	X		X	X	X	X	X	X	X	X	
HACR (2P, 3P)	X	X		X	X	X	X	X	X	X	X	
Connections/Terminations												
Unit Mount	X	X		X	X	X	X	X	X	X	X	
I-Line™	X	X		X	X	X	X	X▼	X▼	X▼	X▼	
Rear Connection	—	—		—	—	—	—	—	—	—	—	
Drawout	—	—		X★	X★	X★	X★	—	—	—	—	
Optional Lugs	X	X		X	X	X	X	X	X	X	X	
Accessories and Modifications												
Shunt Trip	X	X		X	X	X	X	X	X	X	X	
Undervoltage Trip	X	X		X	X	X	X	X	X	X	X	
Auxiliary Switches	X	X		X	X	X	X	X	X	X	X	
Alarm Switch	X	X		X	X	X	X	X	X	X	X	
Motor Operator	—	—		X★	X★	X★	X★	—	—	—	—	
Handle Operators	—	—		X★	X★	X★	X★	—	—	—	—	
Mechanical Interlocks (3P)	—	—		X	X	X	X	—	—	—	—	
Handle Padlock Attachment	X	X		X	X	X	X	X	X	X	X	
Cylinder Lock (3P)	—	—		—	—	—	—	—	—	—	—	
Optional GF Protection	—	—		X	X	X	X	X	X	X	X	
Trip System Type												
Thermal-magnetic	—	—		—	—	—	—	—	—	—	—	
Instantaneous-only (MCP)	—	—		—	X	X	—	—	—	—	—	
Molded Case Switch (Automatic)	—	—		X	X	X	X	X	X	X	X	
Electronic	X	X		X	X	X	X	X	X	X	X	
Enclosures (Pages DE3-56–DE3-58)												
General Purpose (NEMA 1)	X	X		X	X	X	X	—	—	—	—	
Raintight (NEMA 3R)	X	X		X	X	X	X	—	—	—	—	
Dust-tight (NEMA 12)	X	X		X	X	X	X	—	—	—	—	
Watertight (NEMA 4, 4X, 5)	X	X		—	—	—	—	—	—	—	—	
Explosion Proof (NEMA 7, 9)	—	—		—	—	—	—	—	—	—	—	
Dimensions (3P Unit Mount)	Height—in. (mm)	12.80 (325)			16.20 (413)				15 (381)			
	Width—in. (mm)	8.30 (210)			8.30 (210)				16.50 (420)			
	Depth—in. (mm)	8.10 (205)			8.10 (205)				14.40 (366)			
Pages (Unit Mount)/(I-Line)	Page DE3-26/Section DE5			Page DE3-27, DE3-31, DE3-34/Section DE5				Page DE3-28, DE3-34/Section DE5				

Note: All circuit breakers on this chart are UL Listed and CSA Certified unless otherwise noted.

- ▲ Ungrounded UPS systems only. See page DE3-35.
- Dual CSA/UL and IEC ratings and CE markings on circuit breakers.
- ◆ Requires breaker with WB suffix
- ★ 65/50 kA Icu/Ics for 450–600 A ratings.
- ▼ 1000 A and 1200 A only.

		Masterpact 1200 A					Masterpact 6000 A								
															
Circuit Breaker Type		NT-N	NT-H	NT-L1	NT-L	NT-LF ▲	NW-N	NW-H	NW-L	NW-LF ▲	NW-H	NW-L	NW-H	NW-L	
Number of Poles		3, 4	3, 4	3	3	3	3, 4	3, 4	3	3	3, 4	3	3, 4	3	
Current Range		100-1200	100-1200	100-1200	100-1200	100-1200	100-2000	100-2000	100-2000	100-2000	640-3000	640-3000	1200-6000	1200-6000	
Interrupting Ratings															
UL/CSA/NOM Rating (kA RMS) (50/60 Hz)	240 Vac	50	65	100	200	200	65	100	200	200	100	200	100	200	
	480Y/277 Vac	50	50	65	100	100	65	100	150	150	100	150	100	150	
	480 Vac	50	50	65	100	100	65	100	150	150	100	150	100	150	
	600Y/347 Vac	35	50	—	—	—	50	85	100	100	85	100	85	100	
DC Ratings	600 Vac	35	50	—	—	—	50	85	100	100	85	100	85	100	
	250 Vdc	—	—	—	—	—	—	—	—	—	—	—	—	—	
	500 Vdc	—	—	—	—	—	—	—	—	—	—	—	—	—	
IEC ■ (kA RMS) Icu/Ics	240 Vac	—	—	—	—	—	—	—	—	—	—	—	—	—	
	415 Vac	—	—	—	—	—	—	—	—	—	—	—	—	—	
Special Ratings															
	CCC	—	—	—	—	—	—	—	—	—	—	—	—	—	
	Fed. Specs W-C-375B/GEN	—	—	—	—	—	—	—	—	—	—	—	—	—	
	HACR (2P, 3P)	—	—	—	—	—	—	—	—	—	—	—	—	—	
Connections/Terminations															
	Unit Mount	X	X	X	X	X	X	X	X	X	X	X	X	X	
	I-Line™	—	—	—	—	—	—	—	—	—	—	—	—	—	
	Rear Connection	X	X	X	X	X	X	X	X	X	X	X	X	X	
	Drawout	X	X	X	X	X	X	X	X	X	X	X	X	X	
	Optional Lugs	—	—	—	—	—	—	—	—	—	—	—	—	—	
Accessories and Modifications															
	Shunt Trip	X	X	X	X	X	X	X	X	X	X	X	X	X	
	Undervoltage Trip	X	X	X	X	X	X	X	X	X	X	X	X	X	
	Auxiliary Switches	X	X	X	X	X	X	X	X	X	X	X	X	X	
	Alarm Switch	X	X	X	X	X	X	X	X	X	X	X	X	X	
	Motor Operator	X	X	X	X	X	X	X	X	X	X	X	X	X	
	Handle Operators	—	—	—	—	—	—	—	—	—	—	—	—	—	
	Mechanical Interlocks	X	X	X	X	X	X	X	X	X	X	X	X	X	
	Padlock Attachment	X	X	X	X	X	X	X	X	X	X	X	X	X	
	Cylinder Lock	—	—	—	—	—	—	—	—	—	—	—	—	—	
	Optional GF Protection	X	X	X	X	X	X	X	X	X	X	X	X	X	
Trip System Type															
	Thermal-magnetic	—	—	—	—	—	—	—	—	—	—	—	—	—	
	Instantaneous-only (MCP)	—	—	—	—	—	—	—	—	—	—	—	—	—	
	Molded Case Switch (Automatic)	X	X	X	X	X	X	X	X	X	X	X	X	X	
	Electronic	X	X	X	X	X	X	X	X	X	X	X	X	X	
Enclosures															
	General Purpose (NEMA 1)	—	—	—	—	—	—	—	—	—	—	—	—	—	
	Raintight (NEMA 3R)	—	—	—	—	—	—	—	—	—	—	—	—	—	
	Dust-tight (NEMA 12)	—	—	—	—	—	—	—	—	—	—	—	—	—	
	Watertight (NEMA 4, 4X, 5)	—	—	—	—	—	—	—	—	—	—	—	—	—	
	Explosion Proof (NEMA 7, 9)	—	—	—	—	—	—	—	—	—	—	—	—	—	
Dimensions (3P Unit Mount) in. (mm)	Height	12.67 (322)					17.28 (439)				17.28 (439)		17.28 (439)		
	Width	11.25 (286)					17.74 (450)				17.74 (450)		30.94 (786)		
	Depth	13.00 (331)					18.38 (467)				18.38 (467)		18.38 (467)		
Pages		Page DE3-50 and Catalog 0613CT0001					Page DE3-50 and Catalog 0613CT0001								

Note: All circuit breakers on this chart are UL Listed and CSA Certified unless otherwise noted.

- ▲ Tested to show arc flash hazard risk category as reference by NFPA70E.
- See Catalog 0613CT0001 for additional ratings and other information.

DE3 CIRCUIT BREAKERS

Selection Information

Molded Case Circuit Breakers

Class 500, 600, 800

DE3 CIRCUIT BREAKERS

100 A Frame



Circuit Breaker Type	FA (240 V)	FA		FH	FH■	FH	
Number of Poles	1, 2, 3	1	2, 3	1	1	2, 3	
Current Range	15–100	15–100	15–100	15–30	35–100	15–100	
Interrupting Ratings							
UL/CSA/NOM Rating (kA RMS) (50/60 Hz)	240 Vac	10◐	25◐	25	65	25	65
	480Y/277 Vac	—	18	18	65	25	25
	480 Vac	—	—	18	—	—	25
	600Y/347 Vac	—	—	14	—	—	18
	600 Vac	—	—	14	—	—	18
DC Ratings	250 Vdc*	5♦	10♦	10	10♦	10♦	50
	500 Vdc▲*	—	—	—	—	—	20
IEC Rating (kA RMS) Icu/Ics★	240 Vac	—	18/9	—	18/9	—	—
	415 Vac	10/2.5	10/2.5	10/2.5	10/2.5	10/2.5	10/2.5
Special Ratings							
CCC	—	—	—	—	—	—	
Fed. Specs W-C-375B/GEN	X	X	X	X	X	X	
HACR (2P, 3P)	X	—	X	—	—	—	
Connections/Terminations							
Unit Mount	X	X	X	X	X	X	
I-Line™	X	X	X	X	X	X	
Rear Connection	X	X	X	—	—	—	
Drawout	—	—	—	—	—	—	
Optional Lugs	X	X	X	X	X	X	
Accessories and Modifications							
Shunt Trip	X△▼	—	X△	—	—	X△	
Undervoltage Trip	X△▼	—	X△	—	—	X△	
Auxiliary Switches	X△▼	—	X△	—	—	X△	
Alarm Switch	X△▼	X△	X△	X△	X△	X△	
Motor Operator	—	—	X	—	—	X	
Handle Operators	X	—	X	X	X	X	
Mechanical Interlocks (3P)	—	—	X	—	—	X	
Handle Padlock Attachment	X	X	X	X	X	X	
Cylinder Lock (3P△)	—	—	X	—	—	X	
Optional GF Protection□	—	—	X	—	—	X	
Trip System Type							
Thermal-magnetic	X	X	X	X	X	X	
Instantaneous-only (MCP)	—	—	X	—	—	X	
Molded Case Switch (Automatic)	—	—	—	—	—	X	
Electronic	—	—	—	—	—	—	
Enclosures (Pages DE3-56–DE3-58)							
General Purpose (NEMA 1)	X	X	X	X	X	X	
Raintight (NEMA 3R)	X	X	X	X	X	X	
Dust-tight (NEMA 12)	X	X	X	X	X	X	
Watertight (NEMA 4, 4X, 5)	X	X	X	X	X	X	
Explosion Proof (NEMA 7, 9)	X	X	X	X	X	X	
Dimensions (3P Unit Mount) in. (mm)	Height	6 (152)		6 (152)			
	Width	4.5 (114)		4.5 (114)			
	Depth	4.13 (105)		4.13 (105)			
Pages (Unit Mount)/(I-Line)	DE3-63 / Section DE5			DE3-63 / Section DE5			

Note: All circuit breakers on this chart are UL Listed and CSA Certified unless otherwise noted.

- ▲ Ungrounded UPS systems only. See page DE3-35.
- 65 kA @ 120 Vac
- ♦ 1Ø 125 Vdc rating only.
- ★ Dual CSA/UL and IEC ratings and CE markings on circuit breakers.
- ▼ Not available on 1P FA (240 V).

- △ Factory-installed option only.
- Requires factory-installed "G" Shunt trip and 3P module.
- ◇ Not available in HD and HG 2P rating (2P module).
- ☆ 2P in a 3P module.
- ▽ 3P only.
- ◐ 1P FA is 120 Vac.
- * Not available with electronic trip units

400 A L-Frame



Circuit Breaker Type		Q4	LA	LH
Number of Poles		2, 3	2, 3	2, 3
Current Range		250–400	125–400	125–400
Interrupting Ratings				
UL/CSA/NOM Rating (kA RMS) (50/60 Hz)	240 Vac	25	42	65
	480Y/277 Vac	—	30	35
	480 Vac	—	30	35
	600Y/347 Vac	—	22	25
	600 Vac	—	22	25
DC Ratings	250 Vdc	—	10	50
	500 Vdc▲	—	—	20
IEC 60947-2 (kA RMS) Icu/lcs■	240 Vac	—	—	—
	415 Vac	—	20/5	20/5
Special Ratings				
CCC		—	—	—
Fed. Specs W-C-375B/GEN		X	X	X
HACR (2P, 3P)		—	X	X
Connections/Terminations				
Unit Mount		X	X	X
I-Line™		X	X	X
Rear Connection		X	X	X
Drawout		—	—	—
Optional Lugs		X	X	X
Accessories and Modifications				
Shunt Trip		X	X	X
Undervoltage Trip		X	X	X
Auxiliary Switches		X	X	X
Alarm Switch		X	X	X
Motor Operator		X	X	X
Handle Operators		X	X	X
Mechanical Interlocks (3P)		—	X♦	X♦
Handle Padlock Attachment		X	X	X
Cylinder Lock (3P)		X	X	X
Optional GF Protection		—	—	—
Trip System Type				
Thermal-magnetic		X	X	X
Instantaneous-only (MCP)		—	X	X
Molded Case Switch (Automatic)		—	—	X
Electronic		—	—	—
Enclosures (Pages DE3-56–DE3-58)				
General Purpose (NEMA 1)		X	X	X
Raintight (NEMA 3R)		X	X	X
Dust-tight (NEMA 12)		X	X	X
Watertight (NEMA 4, 4X, 5)		X	X	X
Explosion Proof (NEMA 7, 9)		—	—	—
Dimensions (3P Unit Mount) in. (mm)	Height	11 (279)		
	Width	6 (152)		
	Depth	5.84 (148)		
Pages (Unit Mount)/(I-Line)		DE3-64 / Section DE5		

Note: All circuit breakers on this chart are UL Listed and CSA Certified unless otherwise noted.

- ▲ Ungrounded UPS systems only. See page DE3-35.
- Dual CSA/UL and IEC ratings and CE markings on circuit breakers.
- ♦ Requires circuit breaker with WB suffix .

DE3 CIRCUIT BREAKERS

QO™ and QOU Miniature Circuit Breakers

QO™ Miniature Circuit Breakers

Class 730, 731, 733 / Refer to Catalog 0730CT9801

QO™ miniature circuit breakers are plug-on products for use in QO load centers, NQOD panelboards, NQOD OEM interiors or Speed-D™ switchboard distribution panels. Bolt-on QOB circuit breakers are for use in NQOD panelboards or interiors.▲
The QO exclusive Qwik-Open™ mechanism, with a trip reaction within 1/60th of a second, is standard on all 1P 15 A and 20 A QO circuit breakers.

Plug-On Circuit Breakers

Ampere Rating ■	1P—120/240 Vac	2P—120/240 Vac Common Trip	2P—240 Vac ▲ Common Trip	3P—240 Vac Common Trip
	Cat. No.	Cat. No.	Cat. No.	Cat. No.
10 k AIR				
10 A	QO110	QO210	—	QO310
15 A	QO115◆★	QO215◆	QO215H	QO315◆
20 A	QO120◆★	QO220◆	QO220H	QO320◆
25 A	QO125◆	QO225◆	QO225H	QO325◆
30 A	QO130◆	QO230◆	QO230H	QO330◆
35 A	QO135◆	QO235◆	—	QO335◆
40 A	QO140◆	QO240◆	QO240H	QO340◆
45 A	QO145◆	QO245◆	—	QO345◆
50 A	QO150◆	QO250◆	QO250H	QO350◆
60 A	QO160◆	QO260◆	QO260H	QO360◆
70 A	QO170◆	QO270◆	QO270H	QO370◆
80 A	—	QO280◆	QO280H	QO380◆
90 A	—	QO290◆	QO290H	QO390◆
100 A	—	QO2100◆	QO2100H	QO3100◆
110 A	—	QO2110◆	—	—
125 A	—	QO2125◆	—	—
150 A	—	QO2150◆▼▼	—	—
175 A	—	QO2175◆▼▼	—	—
200 A	—	QO2200◆▼▼	—	—
Molded Case Switch 60 A max.—240 Vac		—	QO200	QO300
Molded Case Switch 100 A max.—240 Vac		—	QO2000◇	QO3000◇
22 k AIR◆				
15 A	QO115VH★	QO215VH△	—	QO315VH△
20 A	QO120VH★	QO220VH△	—	QO320VH△
25 A	QO125VH	QO225VH△	—	QO325VH△
30 A	QO130VH	QO230VH△	—	QO330VH△
40 A	—	QO240VH△	—	QO340VH△
50 A	—	QO250VH△	—	QO350VH△
60 A	—	QO260VH△	—	QO360VH△
70 A	—	QO270VH△	—	QO370VH△
80 A	—	QO280VH△	—	QO380VH△
90 A	—	QO290VH△	—	QO390VH△
100 A	—	QO2100VH△□	—	QO3100VH△
110 A	—	QO2110VH△□	—	—
125 A	—	QO2125VH△□	—	—
150 A	—	QO2150VH△▼	—	—
175 A	—	QO2175VH△▼	—	—
200 A	—	QO2200VH△▼	—	—
42 k AIR◆				
40 A	—	QOH240◇	—	—
45 A	—	QOH245◇	—	—
50 A	—	QOH250◇	—	—
60 A	—	QOH260◇	—	—
70 A	—	QOH270	—	—
80 A	—	QOH280	—	—
90 A	—	QOH290	—	—
100 A	—	QOH2100	—	—
110 A	—	QOH2110◇	—	—
125 A	—	QOH2125	—	—
65 k AIR◆				
15 A	QH115★	QH215	—	QH315◆
20 A	QH120★	QH220	—	QH320
25 A	QH125◇	QH225◇	—	QH325◇
30 A	QH130	QH230	—	QH330

QO-QOB Ring Terminal (20% \$ Price Adder)—Factory Installed Only

Ampere Rating	Poles	Suffix
10–30 A	1, 2, 3	5237
35–60 A	1,2	5238
35–50 A	3	
70–110 A	2	5273
60–100 A	3	

Wire Sizes■

Circuit Breaker Type	Ampere Rating	Wire Size (AWG/kcmil)
QO 1P	10–30 A	14–8 Al/Cu
	10–30 A	(2) 14–10 Cu
	35–70 A	8–2 Al/Cu
QO 2P	10–30 A	14–8 Al/Cu
	10–30 A	(2) 14–10 Cu
	35–70 A	8–2 Al/Cu
	80–125 A	4–2/0 Al/Cu
QO 3P	10–30 A	14–8 Al/Cu, (2) 14–10 Cu
	35–70 A	8–2 Al/Cu
QOB-VH	110–150 A	4–300 Al/Cu
	15–20 A	12–8 Al 14–8 Cu
QOT	15–20 A	12–8 Al 14–8 Cu
QO-AFI, QO-GFI & QO-EPD	15–30 A	12–8 Al 14–8 Cu
	40, 50, 60 A	12–4 Al 14–6 Cu
QO-PL	10–60 A	12–2 Al 14–2 Cu

Replacement Tandem Circuit Breakers

For Use in Old Style Non-Class CTL QO Load Centers—10 k AIR

Ampere Rating ■	Cat. No.◆	\$ Price
1P—120/240 Vac—1 Space Required		
15 & 15 A	QO1515	
15 A & 20 A	QO1520	
20 A & 20 A	QO2020	
20 A & 30 A	QO2030	
30 A & 20 A	QO3020	
Two 1P Individual Trip—120/240 Vac—2 Spaces Required		
15 A & 15 A	Order Two QO1515 or QO2020 circuit breakers and handle tie QOTHT for common switching of center two poles.	
15 A & 20 A		
20 A & 20 A		
20 A & 30 A		
30 A & 20 A		



QO 1P
1 Space Required



QOT 1P Tandem
1 Space Required



QO 2P
2 Spaces Required



QO2200 2P 200 A
4 Spaces Required



QO 3P
3 Spaces Required

- ▲ See Section 1 for load centers, and Section 5 for panelboards and interiors.
- 10–30 A circuit breakers are suitable for use with 60°C or 75°C conductors. 35–125 A circuit breakers are suitable for use with 75°C con Delta systems.
- ◆ CSA/UL Listed as HACR type for use with air conditioning, heating and refrigeration equipment having motor group combinations and marked for use with HACR type circuit breakers.
- ★ CSA/UL Listed as SWD (switching duty) rated. Suitable for switching 120 Vac fluorescent lighting loads.
- ▼ Requires four spaces (1 AWG–300 kcmil Al/Cu.) Suitable for switching 120 Vac fluorescent lighting loads.
- △ CSA/UL Listed for use ahead of QO, QO-GFI, QO-EPD, QO-AFI, QOT, QOCAFI, and QO-PL 10 k AIR circuit breakers to permit their application at 22 kA fault level.
- 100 A maximum branch mounted opposite.
- ◇ Order only. Contact your local Field Office.
- ★ Includes two circuit breakers (one QO2030 and one QO3020) and handle tie QOTHT.
- ▼ Not suitable for use in 3Ø panels. Use only in 1Ø panel rated 150 A or greater.

Interrupting Ratings Page DE3-2
Accessories Page DE3-12
Dimensions Page DE3-54



1P
QO-AFI

QO™ Arc-Fault Circuit Breaker

QO arc-fault circuit breakers provide branch feeder protection for series and parallel-type arcing as required by the NEC and local code adoption, and comply with UL1699.



1P
QO-GFI



2P
QO-GFI

QO Arc Fault Circuit Breakers▲

Circuit Breaker Type	Ampere Rating	1P 120 Vac	
		10 k AIR	22 k AIR
		1 Space Required	1 Space Required
		Cat. No.	Cat. No.
Combination Arc-fault Interrupter	15 A	QO115CAFI	QO115VHCAFI
	20 A	QO120CAFI	QO120VHCAFI

QO-GFI

Qwik-Gard™ circuit breakers provide overload and short circuit protection, combined with Class A ground fault interrupter that will trip when a fault current to ground is 6 mA or more, for people protection. Do not connect to more than 250 feet of load conductor for the total one-way run to prevent nuisance tripping.



3P
QO-GFI

QO-GFI Circuit Breakers

Ampere Rating (A)	Qwik-Gard Circuit Breakers With Ground Fault Circuit Interrupter		
	1P 120 Vac		2P Common Trip 120/240 Vac
	10 k AIR	22 k AIR	10 k AIR
	1 Space Required	1 Space Required	2 Spaces Required
Cat. No.			
15	QO115GFI	QO115VHGFI	QO215GFI
20	QO120GFI	QO120VHGFI	QO220GFI
25	QO125GFI	QO125VHGFI	QO225GFI
30	QO130GFI	QO130VHGFI	QO230GFI
40	—	—	QO240GFI
50	—	—	QO250GFI
60	—	—	QO260GFI★



Two-wire
QO-SWN

QO-EPD/EPE

QO-EPD/EPE circuit breakers provide overload and short circuit protection combined with Class B ground fault protection. They are designed to provide ground fault protection of equipment at a 30 milliampere level (EPD) or 100 milliamp level (EPE). They are not designed to protect people from electrical shock.



Three-wire
QO-SWN

QO-EPD Circuit Breakers

Ampere Rating (A)	1P 120 Vac	2P Common Trip 120/240 Vac	3P Common Trip 240 Vac	
	10 k AIR	10 k AIR	10 k AIR	
	1 Space Required	2 Spaces Required	3 Spaces Required	
	Cat. No.			
15	QO115EPD	QO215EPD	QO315EPD▼	QO315EPE▼
20	QO120EPD	QO220EPD	QO320EPD▼	QO320EPE▼
25	QO125EPD	QO225EPD	—	—
30	QO130EPD	QO230EPD	QO330EPD▼	QO330EPE▼
40	—	QO240EPD	QO340EPD▼	QO340EPE▼
50	—	QO250EPD	QO350EPD▼	QO350EPE▼
60	—	QO260EPD★	—	—

QO-SWN

Switch Neutral Common Trip 2008 NEC™ 514.11

QO-SWN Circuit Breakers

Ampere Rating	2 Wire 120 Vac		3 Wire 120/240 Vac	
	10 k AIR		10 k AIR	
	2 Spaces Required		3 Spaces Required	
Cat. No.				
10 A	QO210SWN		—	
15 A	QO215SWN		QO315SWN	
20 A	QO220SWN		QO320SWN	
25 A	QO225SWN		—	
30 A	QO230SWN		QO330SWN	
40 A	QO240SWN		QO340SWN	
50 A	QO250SWN		QO350SWN	



QO 1P
With Shunt Trip



QO-K Key
Operated

HID circuit breakers are for use on circuits feeding fluorescent and high intensity discharge (HID) lighting systems such as mercury vapor, metal halide, or high pressure sodium. These circuit breakers are physically interchangeable with QO circuit breakers.

QO-HID Circuit Breakers

Ampere Rating	1P 120/240 Vac		2P Common Trip 120/240 Vac		3P Common Trip 240 Vac	
	10 k AIR		10 k AIR		10 k AIR	
	1 Space Required		2 Spaces Required		3 Spaces Required	
Cat. No. \$ Price						
15 A	QO115HID■		QO215HID		QO315HID	
20 A	QO120HID■		QO220HID		QO320HID	
25 A	QO125HID		QO225HID		QO325HID	
30 A	QO130HID		QO230HID		QO330HID	
40 A	QO140HID		QO240HID		—	
50 A	QO150HID		QO250HID		—	

QO-K

Key operated QO circuit breakers are available in single-pole construction and can be mounted in any single-pole space which will accept a standard QO. These circuit breakers can be turned ON or OFF or to RESET with a special key (catalog number QOK10) included with the circuit breaker. These circuit breakers are UL Listed and available as shown in the table.

QO-K Circuit Breakers

120 Vac—10 k AIR (1 Space Required)	
Ampere Rating	Cat. No.
10 A	QO110K
15 A	QO115K
20 A	QO120K
30 A	QO130K

QO-HM

High magnetic trip circuit breakers are recommended for applications where high initial inrush may occur and for individual dimmer applications.

QO-HM Circuit Breakers

Ampere Rating	1P Cat. No.
120 Vac—10 k AIR	
15 A	QO115HM▲■
20 A	QO120HM▲■

Non-automatic (Standard) Miniature Switches

Miniature non-automatic switches have the same physical packaging as miniature circuit breakers, but open only when the handle is switched to the OFF position.

Non-automatic switches provide no overcurrent protection or short circuit protection. They must not be used on systems that have an available fault current greater than the values listed in the table.

Non-automatic switches are UL Listed per UL 1087 and are CSA certified.

QO, 240 Vac 10 kA

Ampere Rating	2P	3P
	Cat. No.	Cat. No.
60 A	QO200	QO300
100 A	QO2000	QO3000

- ▲ CSA/UL Listed as HACR type for use with air conditioning, heating and refrigeration equipment having motor group combinations and marked for use with HACR type circuit breakers.
- CSA/UL Listed as SWD (switching duty) rated. Suitable for switching 120 Vac fluorescent lighting loads.
- ◆ 10–30 A circuit breakers are suitable for use with 60° C or 75° C conductors. 35–60 A circuit breakers are suitable for use with 75° C conductors.
- ★ Suitable only for feeding 240 Vac and 208 Vac two-wire loads. Does not contain load neutral connection.
- ▼ See note in Instruction Bulletin when using in an enclosure with a QO403 or QON prefix.

Interrupting Ratings Page DE3-2
Accessories Page DE3-12
Dimensions Page DE3-54

QO-HID

QO™ and QOU Miniature Circuit Breakers

QO™ Circuit Breaker Accessories

Class 1130 / Refer to Catalog 0730CT9801

Accessories for Use with QO™ and QOB Miniature Circuit Breakers

Handle Attachments	Description	Cat. No.
Handle Tie:	Converts any two adjacent 120/240 Vac 1P QO circuit breakers to independent trip 2P Converts any two adjacent 120/240 Vac 1P side-by-side QOT circuit breakers to independent trip 2P Handle tie and lock-off for three 1P QO, QOB circuit breakers	QO1HT QOTHT QO3HT
Handle Clamp:	Clamp for holding QO 1P handle in ON or OFF position Clamp for holding QO or Q1 1P, 2P or 3P circuit breaker handles in ON or OFF position	QO1LO HLO1
Handle Padlock Attachment: for Padlocking in ON or OFF position	For padlocking 1P QO circuit breaker in ON or OFF position Loose attachment Fixed attachment For padlocking 1P side-by-side QOT circuit breaker in ON or OFF position For padlocking 2P and 3P QO-GFI, QO-EPD, and QO-EPE in either ON or OFF position, fixed attachment. For 2P and 3P QO and Q1 standard circuit breakers which require padlocking in either ON or OFF position. Loose attachment Fixed attachment	QOHPL QO1PA QOTHPA GFI2PA QO1HPL QO1PL
Handle Padlock Attachment: for Padlocking in OFF position	For padlocking 1P QO circuit breaker in OFF position only, fixed attachment. For padlocking 2P and 3P QO circuit breakers in OFF position only, fixed attachment. For padlocking 1P QO-GFI, QO-AFI, QO-CAFI, and QO-EPD circuit breakers in OFF position only, fixed attachment. For padlocking 2P and 3P QO-GFI, QO-EPD, and QO-EPE circuit breakers in OFF position only, fixed attachment.	QO1PAF QO2PAF QOGFI1PAF QOGFI2PAF
Sub-Feed Lugs	60 A 2P plug-on – 2 spaces required (6–2 Al/Cu) 125 A 2P plug-on – 2 spaces required (12–2/0 Al/Cu) 225 A 2P plug-on – 4 spaces required (4–300 Al/Cu) 125 A 3P plug-on – 3 spaces required (12–2/0 Al/Cu)	QO60SL QO2125SL QO2225SL▲ QO3125SL
Mechanical Interlock Attachment	For interlocking the handles of two 2P or one 2P and one 1P QO and Q1 circuit breakers mounted side-by-side so that only one circuit breaker can be ON at a time (Not QOU)	QO2DTI
With Retaining Kit:	QO2DTI mechanical interlock attachment with retaining kits for securing two adjacent back-fed circuit breakers in dual power supply applications. Can be used with (2) 2Ps or (1) 2P and (1) 1P QO circuit breakers in QO816L100 load centers.	QO2DTIM

▲ Not suitable for use in 3Ø panels. Use only in 1Ø panel rated 150 A or greater.

DE3 CIRCUIT BREAKERS

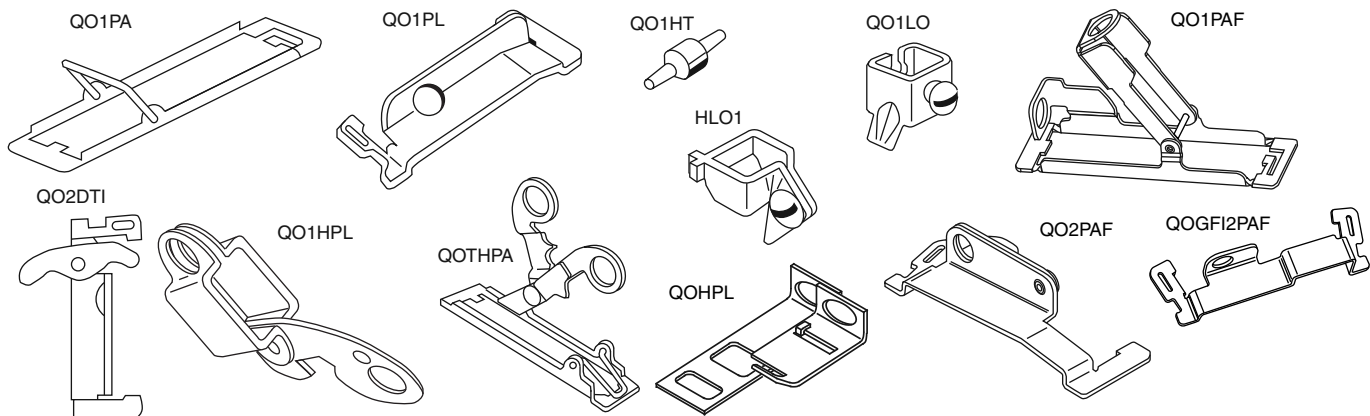

Factory-Installed Accessories for Use with QO and QOB Miniature Circuit Breakers

Factory-installed electrical accessories take up an additional pole space on QO™, QO-GFI, QO-EPD, QO-SWN and QOU circuit breakers. All AC electrical accessories shown below are rated for 50/60 Hz. Accessories are not available for QOB-VH (2P 150 A and 3P 110–150 A) circuit breakers or QO, QOU molded case switches. QO circuit breakers will accept only one accessory per circuit breaker. Undervoltage trip is not available on miniature circuit breakers. Factory-installed accessories are not available for QO-AFI or QO-CAFI Arc Fault Circuit Breakers or on QO2150, QO2175, or QO2200 circuit breakers.

Factory-Installed Accessories

Accessory	Description	Rated Voltage	Coil Burden	Cat. No. Suffix	Accessory	Description	Contact Comb.	Max. Voltage	Max. Load	Cat. No. Suffix	
Shunt Trip	Trips the circuit breaker from a remote location by means of a trip coil energized from a separate circuit. A 120 Vac shunt trip will operate at 55% or more of rated voltage. All other shunt trips will operate at 75% or more of rated voltage. Application • For use with momentary or maintained push button. • Not available on QO-GFI, QO-EPD, QO-AFI, QO-CAFI. • Shunt trip terminals accept (2) 14–12 AWG Cu.	AC/DC	12 24	60 VA 168 VA	-1042	Auxiliary Switches	Monitors circuit breaker contact status and provides a remote signal indicating the circuit breaker contacts are OPEN or CLOSED. Application • Auxiliary switch terminals accept (2) 14–12 AWG Cu leads.	1A 1B	AC 120 AC 120	5 A	-1200
		AC	120 208 240	72 VA 228 VA 288 VA	-1021					5 A	-1201
		Alarm Switches	Used with control circuits and is actuated only when the circuit breaker has tripped. Standard construction includes a normally-open contact. Application • Alarm switch terminals accept (2) 14–12 AWG Cu leads.					1A	AC 120	5 A	-2100

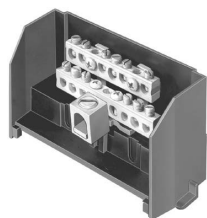

SN12125

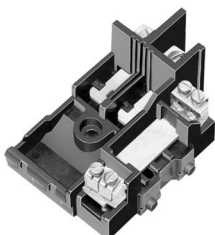

QON2L40

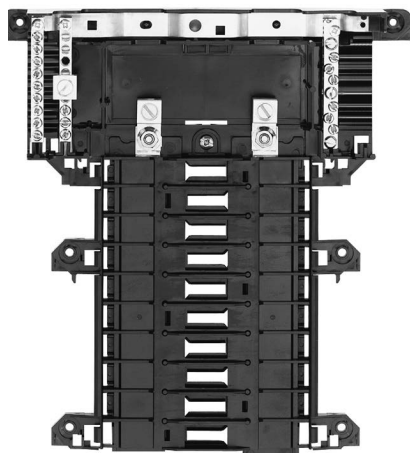

QON120L125I

QO OEM Mounting Bases

Voltage System	Main Lug Rating	1P Spaces	Max. No. 1P	Mounting Bases	Main Wire Size AWG/kcmil	
				Cat. No.		
QO Plug-On Mounting Bases—For unit mounting QO, QO-GFI, QO-AFI and QO-EPD circuit breakers						
1Ø2W 240 Vac Max. 10 k AIC	70 A	2	2	QON2L70	14–4 Cu, 12–3 Al	
	40 A	2	2	QON2L40	14–6 Cu, 12–6 Al	
	70 A	2	4	QON24L70	14–4 Cu, 12–3 Al	
	100 A	6	12	QON612L100	8–1/0 Cu/Al	
	100 A	8	16	QON816L100	8–1/0 Cu/Al	
	125 A	12	12	QON112L125I	4–2/0 Cu/Al	
	1Ø3W 240 Vac Max. 10 k AIC	125 A	16	16	QON116L125I	4–2/0 Cu/Al
		125 A	20	20	QON120L125I	4–2/0 Cu/Al
		125 A	32	32	QON132L125I	4–2/0 Cu/Al
		200 A	12	12	QON124L200I	4–250 Cu/Al
200 A		12	12	QON12L200FTL ■	4–250 Cu/Al	
3Ø3W 240 Vac Max. 10 k AIC (Without Neutral Assy.)	225 A	42	42	QON142L225I	4–300 Cu/Al	
	125 A	12	12	QON312L125	4–2/0 Cu/Al	
	200 A	18	18	QON318L200	4–300 Cu/Al	
	200 A	24	24	QON324L200	4–300 Cu/Al	
3Ø4W 240 Vac Max. 10 k AIC	200 A	30	30	QON330L200	4–300 Cu/Al	
	60 A	3	3	QON403L60N	12–6 Cu/Al	
	125 A	24	24	QON324L125I	4–2/0 Cu/Al	
	200 A	24	24	QON324L200I	4–300 Cu/Al	

QO Plug-On Mounting Bases—For unit mounting QO, QO-GFI and QO-EPD circuit breakers

1Ø2W 240 Vac Max. 10 k AIC (Without Neutral Assembly)	70 A	1	1	QOMB1	14–4 Cu 12–2 Al
	70 A	2	2	QOMB2	14–4 Cu 12–2 Al
	70 A	3	3	QOMB3	14–4 Cu 12–2 Al

QOB Bolt-On Mounting Bases—For unit mounting QOB, QOB-GFI, QOB-EPD circuit breakers

3Ø3W 240 Vac Max. 10 k AIC (Without Neutral Assembly)	100 A	3	3	QON3B ♦	12–1 Cu/Al
---	-------	---	---	---------	------------

- Device comes with factory-installed feed-thru lugs.
- ♦ UL listed only.

Solid Neutral Assemblies

Main Lug Rating	Number of Branch Neutral Terminals	Cat. No.	\$ Price	Main Neutral Lug Wire Size	Branch Neutral Terminal Wire Size	
				Cu/Al	Cu	Al
125 A	20	SN20		4–2/0 AWG	14–4 AWG	12–4 AWG
200 A	12	SN1200		4 AWG–300 kcmil	14–4 AWG	12–4 AWG
200 A	30	SN30		4 AWG–300 kcmil	14–4 AWG	12–4 AWG

Multi-9 Mounting Bases for CSA C22.2 No. 5/UL489 C60, 240 Vac max.



US Mounting Base for CSA C22.2 No. 5/UL489 C60 (3 conductor shown)

Description	Poles	Amperes	Length		Cat. No.
			in.	mm	
One-conductor Mounting Base	12	200 A	10.4	264	US11220018
	24		14.4	366	US12420018
	36		19	483	US13620018
	48		23	584	US14820018
	60		27.5	699	US16020018
Two-conductor Mounting Base	12	150 A	10.4	264	US21215018
	24		14.4	366	US22420018
	36		19	483	US23620018
	48		23	584	US24820018
	60		27.5	699	US26020018
Three-conductor Mounting Base	12	100 A	10.4	264	US31210018
	24		14.4	366	US32420018
	36		19	483	US33620018
	48		23	584	US34820018
	60		27.5	699	US36020018

Accessories for US Mounting Base for CSA C22.2 No. 5/UL489 C60

Description	Cat. No.
Main lug kit for US mounting bases, 1 lug per kit, for 6 AWG to 300 kcmil cable	USMBLK
Terminal cover for US mounting base; provides IP20 ingress protection per IEC 60529; suitable for jumper bars or cable	USMBTC

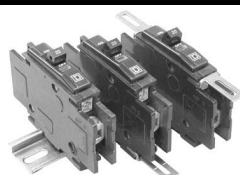

Low Ampere QOU

Low Ampere QOU Miniature Circuit Breakers

QOU unit mount miniature circuit breakers (cable-in/cable-out) are ideal for OEM applications. They have the Square D™ circuit breaker's unique Visi-Trip™ feature and can be DIN rail-mounted or surface- or flush-mounted using mounting feet.

General Specifications Common to All Low Ampere QOU Circuit Breakers

- For convenient flush mount, surface mount or DIN mount (symmetrical rail 35 x 7.5 DIN/EN 50 022)
- Single handle with internal common trip
- Terminal lug wire size (1) 14–2 AWG Cu or Al
- Reversible line and load lugs
- Field-installable quick connectors
- CSA/UL Listed 48 Vdc (5 k AIR)
- CSA/UL Listed as HACR Type: 10–70 A
- High magnetic trip circuit breakers (QOU-HM) are recommended for applications where high initial inrush may occur and for individual dimmer applications.

QOU Low Ampere Miniature Circuit Breakers

Ampere Rating	1P 120/240 Vac	2P 120/240 Vac	2P 240 Vac		3P 240 Vac
	Cat. No.	Cat. No.	Cat. No.▲	\$ Price	Cat. No.
10 k AIR					
10 A	QOU110	QOU210	—		QOU310
15 A	QOU115	QOU215	QOU215H		QOU315
20 A	QOU120	QOU220	QOU220H		QOU320
25 A	QOU125	QOU225	QOU225H		QOU325
30 A	QOU130	QOU230	QOU230H		QOU330
35 A	QOU135	QOU235	—		QOU335
40 A	QOU140	QOU240	—		QOU340
45 A	QOU145	QOU245	—		QOU345
50 A	QOU150	QOU250	—		QOU350
60 A	QOU160	QOU260	—		QOU360
70 A	QOU170	QOU270	—		QOU370
22 k AIR					
15 A	QOU115VH	QOU215VH	—		QOU315VH
20 A	QOU120VH	QOU220VH	—		QOU320VH
25 A	QOU125VH	QOU225VH	—		QOU325VH
30 A	QOU130VH	QOU230VH	—		QOU330VH
35 A	QOU135VH	QOU235VH	—		—
40 A	QOU140VH	QOU240VH	—		—
45 A	QOU145VH	QOU245VH	—		—
50 A	QOU150VH	QOU250VH	—		—
60 A	QOU160VH	QOU260VH	—		—

▲ QOU-H interrupting rating is 10 kA at 240 Vac.

QOU-HM Miniature Circuit Breakers (10 k AIR)

Ampere Rating	1P 120/240 Vac	2P 120/240 Vac	2P 240 Vac	3P 240 Vac
	Cat. No.	Cat. No.	Cat. No.	Cat. No.
15 A	QOU115HM	—	—	—
20 A	QOU120HM	—	—	—

High Ampere QOU Circuit Breakers

General Specifications Common to All High Ampere QOU Circuit Breakers

- Flush mount, surface mount, and DIN rail mount.
- Internal common trip.
- Non-reversible line and load lugs.
- Terminal lug wire size (1) 12– 2/0 AWG Cu or Al.
- UL Listed 60 Vdc per pole (5 k AIR). (**Note:** except switches)
- CSA/UL Listed as HACR type, 80–125 A.
- Non-automatic switches have the same physical packaging as miniature circuit breakers, but provide no overcurrent or short circuit protection. They are UL Listed per UL1087 and are CSA certified.

QOU High Ampere Miniature Circuit Breakers (10 k AIR)

Ampere Rating	1P 120/240 Vac	2P 120/240 Vac	2P 240 Vac	3P 240 Vac
	Cat. No.	Cat. No.	Cat. No.	Cat. No.
80 A	QOU180	QOU280	—	QOU380
90 A	QOU190	QOU290	—	QOU390
100 A	QOU1100	QOU2100	—	QOU3100
125 A	—	QOU2125	—	—

QOU Non-Automatic Switches

Ampere Rating	1P 120 Vac	2P 120/240 Vac	2P 240 Vac	3P 240 Vac
	Cat. No.	Cat. No.	Cat. No.	Cat. No.
60 A	—	—	QOU200	QOU300
100 A	—	—	QOU2000	QOU3000
125 A	—	—	QOU20001	QOU30001

Interrupting Ratings Page DE3-3
Accessories Page DE3-12, DE3-15
Dimensions Page DE3-54

DE3 CIRCUIT BREAKERS



High Ampere QOU

Accessories for QOU Low Ampere Circuit Breakers (Except as Noted)

Description	Order Qty.	Cat. No.
Factory-installed ring tongue terminal, 10–32 screw, for 1P, 2P, 3P QOU, 10–60 A	—	Suffix -5283
Hex drive 5/32 in. wire binding screw for QOU	—	Suffix -5280
For padlocking 1P low ampere QOU circuit breaker in OFF or ON position	—	QOU1PA
For padlocking 2P and 3P low ampere QOU circuit breaker in OFF or ON position	—	QOU1PL
For padlocking 1P low ampere QOU circuit breaker in OFF position only	—	QOU1PAFLA
For padlocking 2P and 3P low ampere QOU circuit breaker in OFF position only	—	QOU2PAFLA
For padlocking 2P and 3P high ampere QOU circuit breaker in OFF position only	—	Suffix -7100
Handle lock-out, ON or OFF position	—	HLO1
4P 100 A Jumper bar assy. w/front wiring with base, cover and screw	1	QOU14100JBAF
4P 100 A Jumper bar assy. w/right side wiring with base, cover and screw	1	QOU14100JBAL
4P 100 A Jumper bar assy. w/left side wiring with base, cover and screw	1	QOU14100JBAL
1Ø, 4P, 100 A Jumper bar base with front wiring	40	QOU14100BAFB
1Ø, 4P, 100 A Jumper bar base with left side wiring	40	QOU14100BALB
1Ø, 4P, 100 A Jumper bar base with right side wiring	40	QOU14100BARB
4P Jumper bar cover	40	QOU14100CAB
Mounting screw for jumper bar cover	40	QOU1CMSB
6P 150 A Jumper bar assy. w/front wiring with base, cover and screw	1	QOU16150JBAF
1Ø, 6P, 150 A Jumper bar base with front wiring	40	QOU16150BAFB
1Ø, 6P, 150 A Jumper bar base with left side wiring	40	QOU16150BALB
1Ø, 6P, 150 A Jumper bar base with right side wiring	40	QOU16150BARB
6P jumper bar cover	40	QOU16150CAB
Vertical rainproof cover 2P and 3P QO, QOU, FA and KA	1 10	BCV▲ BCVB▲
Horizontal rainproof cover 2P QO, QOU, and 3P Q2, EH	1 10	BCH▲ BCHB▲
1P Fingersafe™ cover for high ampere QOU circuit breaker	1 40	QOUHFSC1 QOUHFSC1B
1P Fingersafe cover for low ampere QOU circuit breaker	1 40	QOULFSC1 QOULFSC1B
Cover plate for one 2P QOU circuit breaker	1 40	QOUCP2 QOUCP2B
Cover plate for one 3P QOU circuit breaker	1 40	QOUCP3 QOUCP3B
Cover plate for two 2P QOU circuit breakers	1 40	QOUCP4 QOUCP4B
Cover plate for three 2P QOU circuit breakers	1 40	QOUCP6 QOUCP6B
Field-installable ring tongue terminal adaptor	1 80	QOURT QOURTB
Quick connector end connection wiring	1 40	QOUEC QOUECB
Quick connector forward or reverse wiring	1 40	QOUGFR QOUGFRB
1P QOU mounting foot	1 80	QOUMF1▲ QOUMF1B▲
2P QOU mounting foot	1 40	QOUMF2▲ QOUMF2B▲
3P QOU mounting foot	1 24	QOUMF3▲ QOUMF3B▲
Tapped mounting foot for QOU, 1P and 2P 10–70 A, 3P 10–60 A		
Packaged with circuit breaker		Suffix -3100
Individually packaged	1	QOUMFS1
Bulk packed	80	QOUMFS1B
Mechanical interlock attachment: Used to interlock two circuit breakers mounted side-by-side so that only one circuit breaker can be ON at a time. A 1P or 2P circuit breaker can be mounted on the left and interlocked with a 2P or 3P circuit breaker on the right.	1	QOU2DTILA ■

- ▲ For use on low and high ampere QOU.
- 10–70 A 1P and 2P, 10–60 A 3P.

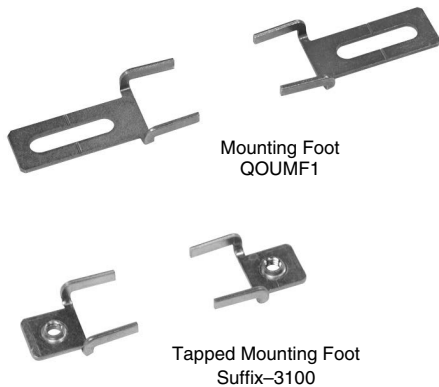
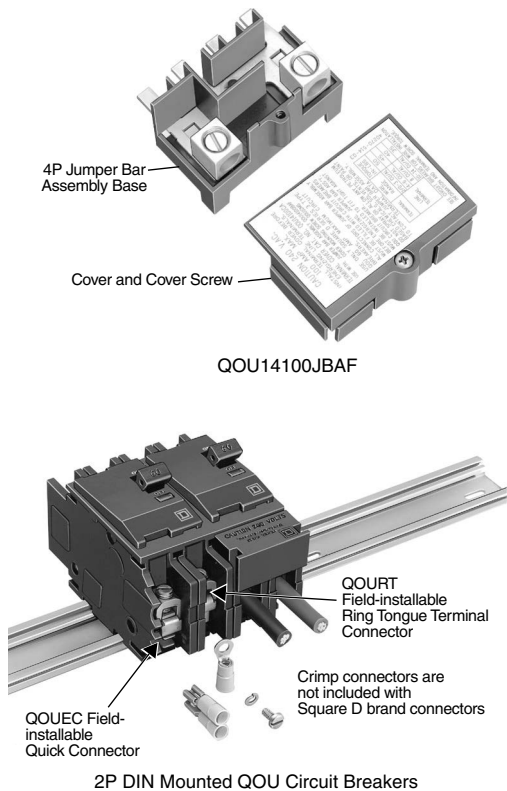

For QOUQ Low Ampere Circuit Breakers with Four-Point Quick-Connect Terminals

QOUQ low ampere circuit breakers with four-point quick-connect terminals are provided with permanent factory-installed terminals which are affixed to the Load or OFF end of the circuit breaker. This special terminal will accommodate up to four 1/4-inch insulated female quick connect wire terminations. Total ampacity of these connections must not exceed the rating of the circuit breaker.

QOUQ Four-Point Quick-Connect Terminals

	Poles	Order Qty.	Cat. No.
Four-Point Quick-Connect Terminals	1	1	Change QOU to QOUQ
	2	1	
	3	1	

Multi 9™ Miniature Circuit Breakers

CSA C22.2 No. 5/UL 489 C60 Miniature Circuit Breakers

Class 860 / Refer to Catalog 0860CT0201



1P C60
Box lug



2P C60
Box lug



3P C60
Box lug



Ring Tongue C60

Multi 9 C60 CSA C22.2 No. 5/UL 489 Listed 240 V Miniature Circuit Breakers

- UL 489 Listed and CSA 22.2 No. 5.1 for branch circuit protection
- Eliminates concerns and uncertainty of using a CSA C22.2 No. 235/UL 1077 device where a CSA C22.2 No. 5/UL 489 device is required
- Replaces fuses in low-ampere range; 17 ratings up to 35 A

Trip Curve	Use	Magnetic Release
C	For typical loads	7–10 x ampere rating (7–14 for DC)
D	For high inrush	10–14 x ampere rating

- 10 k AIR (1P @ 120 Vac; 2P and 3P @ 240 Vac)
- 60 Vdc for 1P and 125 Vdc for 2P (on C-curve circuit breakers only, see table below)
- Increased installation flexibility with standard box lugs or optional ring terminals
- Allows easy front-mounting and rear wiring when using ring terminals
- A wide range of electrical and mechanical accessories
- Suitable for reverse feeding
- Trip-free mechanism
- Positive indication of contact disconnect

CSA C22.2 No. 5/UL 489 Circuit Breakers (120/240 V)

Rating (A)	C Curve—7–10 Times Ampere Rating (7–14 DC)			D Curve—10–14 Times Ampere Rating		
	1P ▲	2P ■	3P	1P	2P	3P
	Cat. No.	Cat. No.	Cat. No.	Cat. No.	Cat. No.	Cat. No.
Box Lug/Box Lug						
0.5	60100	60134	—	60117	60151	—
1	60101	60135	60168	60118	60152	60184
1.5	60102	60136	60169	60119	60153	60185
2	60103	60137	60170	60120	60154	60186
3	60104	60138	60171	60121	60155	60187
4	60105	60139	60172	60122	60156	60188
5	60106	60140	60173	60123	60157	60189
6	60107	60141	60174	60124	60158	60190
7	60108	60142	60175	60125	60159	60191
8	60109	60143	60176	60126	60160	60192
10	60110	60144	60177	60127	60161	60193
13	60111	60145	60178	60128	60162	60194
15	60112	60146	60179	60129	60163	60195
20	60113	60147	60180	60130	60164	60196
25	60114	60148	60181	60131	60165	60197
30	60115	60149	60182	60132	60166	60198
35	60116	60150	60183	60133	60167	60199
Ring Tongue/Ring Tongue						
0.5	60200	60234	—	60217	60251	—
1	60201	60235	60268	60218	60252	60284
1.5	60202	60236	60269	60219	60253	60285
2	60203	60237	60270	60220	60254	60286
3	60204	60238	60271	60221	60255	60287
4	60205	60239	60272	60222	60256	60288
5	60206	60240	60273	60223	60257	60289
6	60207	60241	60274	60224	60258	60290
7	60208	60242	60275	60225	60259	60291
8	60209	60243	60276	60226	60260	60292
10	60210	60244	60277	60227	60261	60293
13	60211	60245	60278	60228	60262	60294
15	60212	60246	60279	60229	60263	60295
20	60213	60247	60280	60230	60264	60296
25	60214	60248	60281	60231	60265	60297
30	60215	60249	60282	60232	60266	60298
35	60216	60250	60283	60233	60267	60299

- ▲ 1P dual rated 120 Vac/60 Vdc.
- 2P dual rated 240 Vac/125 Vdc.

Interrupting ratings Page DE3-3
 Accessories Page DE3-20
 Dimensions Page DE3-54
 Mounting Bases Page DE3-13

DE3 CIRCUIT BREAKERS



1P
UL489 C60

Multi 9 C60 CSA C22.2 No.5/UL 489 Listed 480V Miniature Circuit Breakers

- UL 489 Listed, CSA C22.2 No. 5.1; Also IEC 60947-2; CE marked
- 480Y/277 Vac @ 10 kA (2P and 3P), 277 Vac @ 10 kA (1P)
- 0.5 A through 20 A
- 1P, 2P, 3P, 18 mm wide per pole

Trip Curve	Use	Magnetic Release
C	For typical loads	7–10 x ampere rating (7–14 for DC)
D	For high inrush	10–14 x ampere rating

- UL 486B Listed single-barrel lug: (2) 18–10 AWG (1-25 mm²) cables, Cu only
- Optional ring tongue terminals
- A wide range of electrical and mechanical accessories
- Suitable for reverse feeding
- Trip-free mechanism
- Positive indication of contact disconnect



2P
UL489 C60

CSA C22.2 No.5/UL 489 Circuit Breakers (480Y/277 Vac)

Rating (A)	C Curve—7–10 Times Ampere Rating (7–14 DC)			D Curve—10–14 Times Ampere Rating		
	1P	2P	3P	1P	2P	3P
	Cat. No.	Cat. No.	Cat. No.	Cat. No.	Cat. No.	Cat. No.
Single-Barrel Wire Lug						
0.5	MGN61300	—	—	MGN61333	—	—
1	MGN61301	MGN61312	MGN61323	MGN61334	MGN61345	MGN61356
2	MGN61302	MGN61313	MGN61324	MGN61335	MGN61346	MGN61357
3	MGN61303	MGN61314	MGN61325	MGN61336	MGN61347	MGN61358
4	MGN61304	MGN61315	MGN61326	MGN61337	MGN61348	MGN61359
5	MGN61305	MGN61316	MGN61327	MGN61338	MGN61349	MGN61360
6	MGN61306	MGN61317	MGN61328	MGN61339	MGN61350	MGN61361
8	MGN61307	MGN61318	MGN61329	MGN61340	MGN61351	MGN61362
10	MGN61308	MGN61319	MGN61330	MGN61341	MGN61352	MGN61363
15	MGN61309	MGN61320	MGN61331	MGN61342	MGN61353	MGN61364
20	MGN61310	MGN61321	MGN61332	MGN61343	MGN61354	MGN61365
Ring Tongue Terminal						
0.5	MGN61366	—	—	MGN61399	—	—
1	MGN61367	MGN61378	MGN61389	MGN61400	MGN61411	MGN61422
2	MGN61368	MGN61379	MGN61390	MGN61401	MGN61412	MGN61423
3	MGN61369	MGN61380	MGN61391	MGN61402	MGN61413	MGN61424
4	MGN61370	MGN61381	MGN61392	MGN61403	MGN61414	MGN61425
5	MGN61371	MGN61382	MGN61393	MGN61404	MGN61415	MGN61426
6	MGN61372	MGN61383	MGN61394	MGN61405	MGN61416	MGN61427
8	MGN61373	MGN61384	MGN61395	MGN61406	MGN61417	MGN61428
10	MGN61374	MGN61385	MGN61396	MGN61407	MGN61418	MGN61429
15	MGN61375	MGN61386	MGN61397	MGN61408	MGN61419	MGN61430
20	MGN61376	MGN61387	MGN61398	MGN61409	MGN61420	MGN61431



3P
UL489 C60

Interrupting Rating Page DE3-3
 Accessories Page DE3-20
 Dimensions Page DE3-54

DE3
CIRCUIT BREAKERS



1P C60H-DC



2P C60H-DC

Multi 9 C60H-DC UL 1077 Recognized (not CSA certified) Supplementary Protectors (250 and 500 Vdc)

The C60H-DC supplementary protectors are used in direct current circuits (industrial control and automation, transport, renewable energy, etc.). They provide overcurrent protection within appliances or electrical equipment.

- Range from 0.5–40 A
- 5 k AIR at 250 Vdc (1-pole) and 5 k AIR at 500 Vdc (2-pole, wired in series)
- Trip-free mechanism
- Positive indication of contact disconnect
- C-Curve: 7 to 14 times ampere rating
- UL 1077, IEC 60947-2, EN 60947-2, GB 14048.2, CCC and CE mark
- **Not CSA certified**

Multi 9 C60H-DC UL 1077 Recognized (not CSA certified) Supplementary Protectors

Current (A) ▲	1-Pole 24–250 Vdc	2-Pole 24–500 Vdc
	Cat. No.	Cat. No.
0.5	MGN61500	MGN61520
1	MGN61501	MGN61521
2	MGN61502	MGN61522
3	MGN61503	MGN61523
4	MGN61504	MGN61524
5	MGN61505	MGN61525
6	MGN61506	MGN61526
10	MGN61508	MGN61528
13	MGN61509	MGN61529
15	MGN61510	MGN61530
16	MGN61511	MGN61531
20	MGN61512	MGN61532
25	MGN61513	MGN61533
30	MGN61514	MGN61534
32	MGN61515	MGN61535
40	MGN61517	MGN61537

▲ At 25°C/77°F, for other temperatures see temperature derating table in Multi 9 Catalogue 0860CT0201.

Class 685, 690, 730, 912, 950 / Refer to Catalog 0730CT9801 **Multi 9™ Miniature Circuit Breakers**
CSA C22.2 No. 235/UL 1077 C60 Supplementary Protectors

Intended for use within equipment where branch circuit protection is already provided or not needed

- Range from 0.5 to 63 A
- 10 k AIR @ 120/240 Vac; 5 k AIR at 480Y/277; 10 k AIR @ 60 Vdc (1P) and 125 Vdc (2P)
- Suitable for reverse feeding
- DIN mounting for easy installation
- Suitable for reverse feeding

- A wide range of electrical and mechanical accessories
- Trip-free mechanism
- Positive indication of contact disconnect

Trip Curve	Use	Magnetic Release
B	For sensitive equipment	3.2–4.8 x ampere rating
C	For typical loads	7–10 x ampere rating (7–14 for DC)
D	For high inrush	10–14 x ampere rating

CSA C22.2 No. 235/UL 1077 Supplementary Protectors

Rating (A)	1P	\$ Price	2P	3P	4P
B Curve—Magnetic Setting Between 3.2 and 4.8 Times Ampere Rating					
1	MG24110		MG24125	MG24140	MG24155
1.2	MG17402		MG17432	—	—
1.5	MG17403		MG17433	—	—
2	MG24111		MG24126	MG24141	MG24156
3	MG24112		MG24127	MG24142	MG24157
4	MG24113		MG24128	MG24143	MG24158
5	MG17404		MG17434	—	—
6	MG24114		MG24129	MG24144	MG24159
7	MG17405		MG17435	—	—
8	MG24115		MG24130	MG24145	MG24160
10	MG24116		MG24131	MG24146	MG24161
13	MG24117		MG24132	MG24147	MG24162
15	MG17406		MG17436	MG17461	—
16	MG24118		MG24133	MG24148	MG24163
20	MG24119		MG24134	MG24149	MG24164
25	MG24120		MG24135	MG24150	MG24165
30	MG17407		MG17437	MG17462	—
32	MG24121		MG24136	MG24151	MG24166
35	MG17408		MG17438	MG17463	—
40	MG24122		MG24137	MG24152	MG24167
50	MG24123		MG24138	MG24153	MG24168
60	MG17409		MG17439	MG17464	—
63	MG24124		MG24139	MG24154	MG24169
C Curve—Magnetic Setting Between 7 and 10 Times Ampere Rating					
0.5	MG17411		—	—	—
1	MG24425		MG24442	MG24459	MG24476
1.2	MG17412		MG17442	—	—
1.5	MG17413		MG17443	—	—
2	MG24426		MG24443	MG24460	MG24477
3	MG24427		MG24444	MG24461	MG24478
4	MG24428		MG24445	MG24462	MG24479
5	MG17414		MG17444	—	—
6	MG24430		MG24447	MG24464	MG24481
7	MG17415		MG17445	—	—
8	MG24431		MG24448	MG24465	MG24482
10	MG24432		MG24449	MG24466	MG24483
13	MG24433		MG24450	MG24467	MG24484
15	MG17416		MG17446	MG17466	—
16	MG24434		MG24451	MG24468	MG24485
20	MG24435		MG24452	MG24469	MG24486
25	MG24436		MG24453	MG24470	MG24487
30	MG17417		MG17447	MG17467	—
32	MG24437		MG24454	MG24471	MG24488
35	MG17418		MG17448	MG17468	—
40	MG24438		MG24455	MG24472	MG24489
50	MG24439		MG24456	MG24473	MG24490
60	MG17419		MG17449	MG17469	—
63	MG24440		MG24457	MG24474	MG24491
D Curve—Magnetic Setting Between 10 and 14 Times Ampere Rating					
0.5	MG17421		—	—	—
1	MG24500		MG24516	MG24532	MG24548
1.2	MG17422		MG17452	—	—
1.5	MG17423		MG17453	—	—
2	MG24501		MG24517	MG24533	MG24549
3	MG24502		MG24518	MG24534	MG24550
4	MG24503		MG24519	MG24535	MG24551
5	MG17424		MG17454	—	—
6	MG24504		MG24520	MG24536	MG24552
7	MG17425		MG17455	—	—
8	MG24505		MG24521	MG24537	MG24553
10	MG24506		MG24522	MG24538	MG24554
13	MG24507		MG24523	MG24539	MG24555
15	MG17426		MG17456	MG17471	—
16	MG24508		MG24524	MG24540	MG24556
20	MG24509		MG24525	MG24541	MG24557
25	MG24510		MG24526	MG24542	MG24558
30	MG17427		MG17457	MG17472	—
32	MG24511		MG24527	MG24543	MG24559
35	MG17428		MG17458	MG17473	—
40	MG24512		MG24528	MG24544	MG24560
50	MG24513		MG24529	MG24545	MG24561
60	MG17429		MG17459	MG17474	—
63	MG24514		MG24530	MG24546	MG24562

Interrupting Ratings Page DE3-3
 Accessories Page DE3-20

Dimensions Page DE3-54

DE3 CIRCUIT BREAKERS



1P
UL 1077 C60



2P
UL 1077 C60



3P
UL 1077 C60



4P
UL 1077 C60

Multi 9™ Miniature Circuit Breakers

C60 Accessories

Class 860 / Refer to Catalog 0860CT0201

Electrical Accessories for C60 Circuit Breakers and Supplementary Protectors

Possible Combinations

Mounted to the left of the circuit breaker with a maximum width of 54 mm.

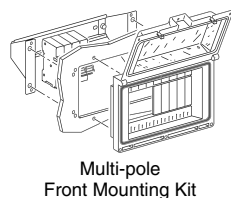
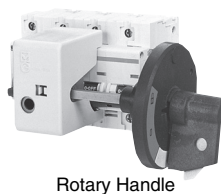
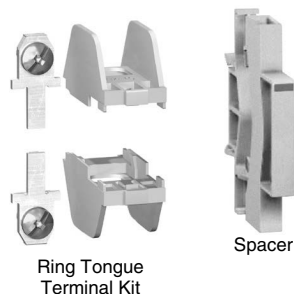
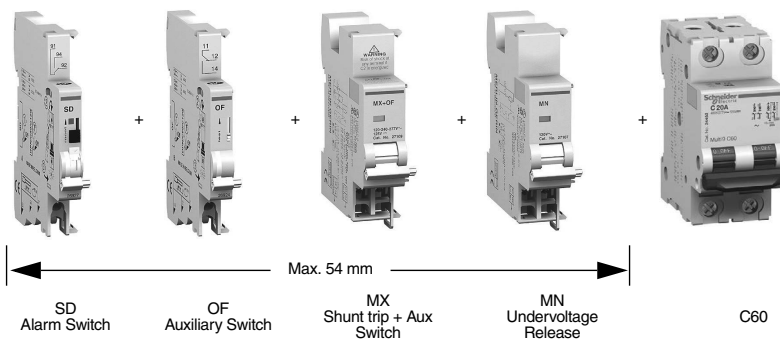

Multi 9 C60 Electrical Accessories

Descriptions	Control Voltage		Width in 9 mm modules	C60 UL/IEC Cat. No.
	Vac	Vdc		
OF Auxiliary Switch (1a1b)	12–277	12–125	1	MG26925
SD Alarm Switch (1a1b)	12–277	12–125	1	MG26928
MX Shunt Trip + OF Auxiliary Switch (1a1b)	24	24	2	27118
	48	48	2	27110
	110–240–277	125	2	27109
MN Undervoltage Release	24	24	2	27108
	48	48	2	27106
	120	—	2	27107
	240	—	2	27105

Multi 9 C60 Mechanical Accessories

Descriptions	C60	
	Cat. No.	
Ring tongue terminal kit for UL1077 C60	For one pole	17400
Spacer for DIN rail, Not UL Recognized	9 mm wide	MG27062
Padlock Attachment (1 per for 1P, 2P, 3P or 4P)	2 per pack	MG26970
Padlocking Device Left Side Mount, Locks OFF only▲	1 per pack	MGN26380
Padlocking Device Right Side Mount, Locks OFF only■		MGN26381
Front Mounting Kit	1P	MG26983
	2P	MG26984
	3P	MG26985
	4P	MG26989
Terminal Screw Shield (Not UL Recognized)	Bag of two 4P shields	MG26981
Terminal cover (Not CSA/UL Recognized)	1P	MG26975
	2P	MG26976
	3P	MG26975+MG26976
	4P	MG26978
Tooth Caps for UL Comb Bus Bar, Bag of 20		60488
Rotary Handle for C60 (Non UL Recognized)		
Operating Subassembly	2P/3P/4P	MG27046
Door Interlock Handle		MG27047
Fixed Handle (Front or Lateral)		MG27048
Multi-pole Front Mounting Kit		
Rail Support (20 of 9 mm modules)		14211
Hinged Transparent Cover		14210

- ▲ Left-side mounted padlocking device cannot be used in conjunction with accessories SD, OF, MX or MN. Use right-side mounted padlocking device when accessories are required.
- Right-side mounted padlocking device cannot be used in conjunction with VIGI module. Use left-side mounted padlocking device when VIGI Module is required..

The PowerPact Advantage

- **Proven Performance:** Industry-leading circuit breaker innovation and protection for heavy-duty commercial and industrial applications.
- **Smart:** Integrated metering options provide a cost-effective solution to reduce energy consumption, optimize energy costs, and improve energy availability for your facilities.
- **Flexible:** Full range of thermal-magnetic and electronic trip molded case circuit breakers from 15 A to 3000 A, delivering the ratings, configurations, and operators for your unique applications.
- **Simple:** Common catalog numbers, standardized ratings, and a full range of field-installable accessories make product selection, installation and maintenance easier than ever.
- **Common Design Features:** Mounting holes, door trim, and handle accessories.

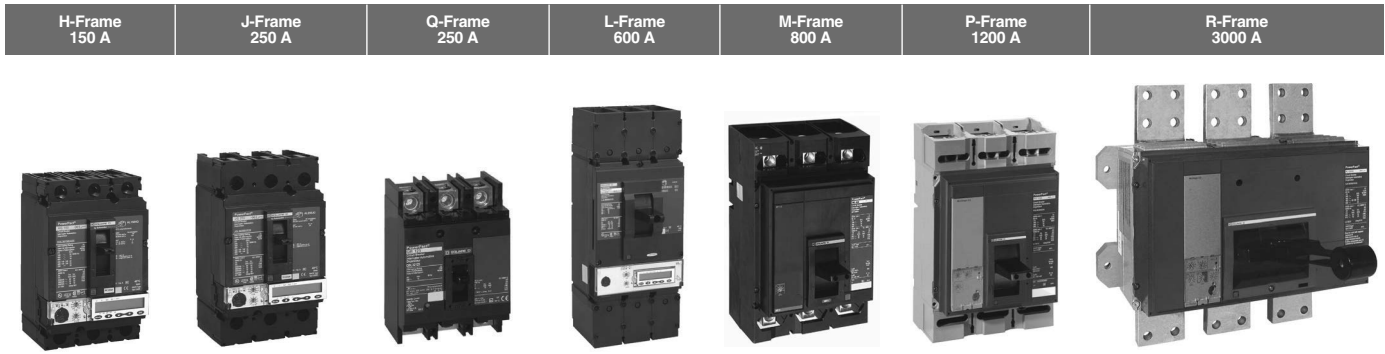

PowerPact Interrupting Ratings

Voltage	Interrupting Rating						
	B	D	G	J	K	L	R
240 Vac	10 kA	25 kA	65 kA	100 kA	65 kA	125 kA	200 kA
480 Vac		18 kA	35 kA	65 kA ▲	65 kA ▲	100 kA	200 kA
600 Vac		14 kA	18 kA	25 kA	65 kA ▲	50 kA ■	100 kA

- ▲ P-frame K interrupting is 50 kA at 480 and 600 Vac.
- P-frame L interrupting is 25 kA at 600 Vac.

Common Catalog Numbering System

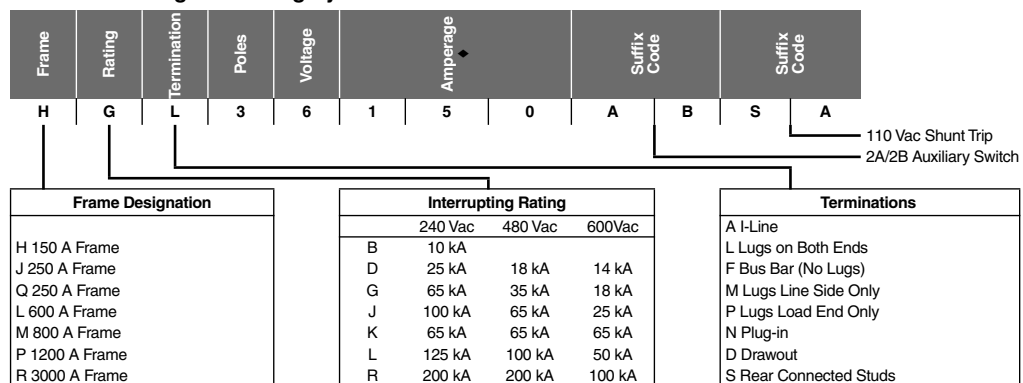

♦ For amperage of M-, P- or R-frame circuit breakers, add a zero to the three amperage digits; for example, 120 = 1200 A.

Description	Page
H- and J-Frame Circuit Breakers	DE3-22
H- and J-Frame Circuit Breakers	DE3-23
Q-Frame Circuit Breakers	DE3-24
L-Frame Circuit Breakers	DE3-25
P-Frame Circuit Breakers	DE3-27
R-Frame Circuit Breakers	DE3-28
PowerPact™ H- and J-Frame Electronic Motor Circuit Protectors	DE3-29
Motor Circuit Protectors and Motor Protector Circuit Breakers	DE3-31
Automatic Switches	DE3-34
500 Vdc Circuit Breakers	DE3-35
Mission Critical Circuit Breakers	DE3-37
PowerPact™ Circuit Breaker Accessories	DE3-39
Motor Operators and Rotary Handles	DE3-40
Locks, Installation Accessories, and Rear Connections	DE3-41
Mechanical Lugs	DE3-41
Compression Lugs and Power Distribution Connectors (PDC)	DE3-43
Terminal Nuts, Terminal Pads, Terminal Shields and Accessories	DE3-44
Plug-In and Drawout Mountings	DE3-45
Micrologic™ Electronic Trip Units	DE3-46
Micrologic™ Trip Unit Accessories	DE3-48

PowerPact™ Circuit Breakers

H- and J-Frame Circuit Breakers

Class 611 / Refer to Catalog 0611CT1001



HD and HG 2 Pole Thermal-Magnetic Trip Unit



H-Frame Thermal-Magnetic Trip Unit

DE3 CIRCUIT BREAKERS

H-frame 150 A Thermal-magnetic CSA/UL Current-Limiting ▼ Circuit Breakers (600 Vac) with Factory Sealed Trip Unit Suitable for Reverse Connection ■▲

Current Rating @ 40° C	AC Magnetic Trip Setting		D Interrupting	G Interrupting	J Interrupting ▼	L Interrupting ▼	Terminal Wire Range
	Hold	Trip	Catalogue Number ▲	Catalogue Number ▲	Catalogue Number ▲	Catalogue Number ▲	
2-pole, 600 Vac 50/60 Hz							
15	350	750	HDL26015	HGL26015	HJL26015	HLL26015	AL150HD #14-#3/0 AWG Cu or Al
20	350	750	HDL26020	HGL26020	HJL26020	HLL26020	
25	350	750	HDL26025	HGL26025	HJL26025	HLL26025	
30	350	750	HDL26030	HGL26030	HJL26030	HLL26030	
35	400	850	HDL26035	HGL26035	HJL26035	HLL26035	
40	400	850	HDL26040	HGL26040	HJL26040	HLL26040	
45	400	850	HDL26045	HGL26045	HJL26045	HLL26045	
50	400	850	HDL26050	HGL26050	HJL26050	HLL26050	
60	800	1450	HDL26060	HGL26060	HJL26060	HLL26060	
70	800	1450	HDL26070	HGL26070	HJL26070	HLL26070	
80	800	1450	HDL26080	HGL26080	HJL26080	HLL26080	
90	800	1450	HDL26090	HGL26090	HJL26090	HLL26090	
100	900	1700	HDL26100	HGL26100	HJL26100	HLL26100	
110	900	1700	HDL26110	HGL26110	HJL26110	HLL26110	
125	900	1700	HDL26125	HGL26125	HJL26125	HLL26125	
150	900	1700	HDL26150	HGL26150	HJL26150	HLL26150	
3-pole, 600 Vac 50/60 Hz							
15	350	750	HDL36015	HGL36015	HJL36015	HLL36015	AL150HD #14-#3/0 AWG Cu or Al
20	350	750	HDL36020	HGL36020	HJL36020	HLL36020	
25	350	750	HDL36025	HGL36025	HJL36025	HLL36025	
30	350	750	HDL36030	HGL36030	HJL36030	HLL36030	
35	400	850	HDL36035	HGL36035	HJL36035	HLL36035	
40	400	850	HDL36040	HGL36040	HJL36040	HLL36040	
45	400	850	HDL36045	HGL36045	HJL36045	HLL36045	
50	400	850	HDL36050	HGL36050	HJL36050	HLL36050	
60	800	1450	HDL36060	HGL36060	HJL36060	HLL36060	
70	800	1450	HDL36070	HGL36070	HJL36070	HLL36070	
80	800	1450	HDL36080	HGL36080	HJL36080	HLL36080	
90	800	1450	HDL36090	HGL36090	HJL36090	HLL36090	
100	900	1700	HDL36100	HGL36100	HJL36100	HLL36100	
110	900	1700	HDL36110	HGL36110	HJL36110	HLL36110	
125	900	1700	HDL36125	HGL36125	HJL36125	HLL36125	
150	900	1700	HDL36150	HGL36150	HJL36150	HLL36150	

J-frame 250 A Thermal-magnetic (600 Vac) Factory Sealed Trip Unit Suitable for Reverse Connection ■▲

Current Rating @ 40° C	AC Magnetic Trip Setting		D Interrupting	G Interrupting	J Interrupting ▼	L Interrupting ▼	R Interrupting ▼	Terminal Wire Range
	Low	High	Catalogue Number ▲	Catalogue Number ▲	Catalogue Number ▲	Catalogue Number ▲	Catalogue Number ▲	
2-pole, 600 Vac 50/60 Hz								
150	750	1500	JDL26150	JGL26150	JJL26150	JLL26150	-	AL175JD #4-4/0 AWG Al or Cu
175	875	1750	JDL26175	JGL26175	JJL26175	JLL26175	-	
200	1000	2000	JDL26200	JGL26200	JJL26200	JLL26200	-	AL250JD #3/0-350 kcmil Al or Cu
225	1125	2250	JDL26225	JGL26225	JJL26225	JLL26225	-	
250	1250	2500	JDL26250	JGL26250	JJL26250	JLL26250	-	
3-pole, 600 Vac 50/60 Hz								
150	750	1500	JDL36150	JGL36150	JJL36150	JLL36150	JRL36150	AL175JD #4-4/0 AWG Al or Cu
175	875	1750	JDL36175	JGL36175	JJL36175	JLL36175	JRL36175	
200	1000	2000	JDL36200	JGL36200	JJL36200	JLL36200	JRL36200	AL250JD #3/0-350 kcmil Al or Cu
225	1125	2250	JDL36225	JGL36225	JJL36225	JLL36225	JRL36225	
250	1250	2500	JDL36250	JGL36250	JJL36250	JLL36250	JRL36250	

- See catalogue for circuit breakers with field interchangeable trip units.
- ▲ For 100% rated circuit breakers, add a "C" in the 9th character place (for example, HDL36015C or JDL26150C). 100% rated circuit breakers have copper lugs and can only be used with copper wire.
- ▼ Circuit breakers with J, L, and R interrupting ratings are CSA/UL certified as current limiting.

H- and J-frame Termination Options

Interrupting Ratings (kA)

Voltage	D	G	J	L	R
240 V	25	65	100	125	200
480 V	18	35	65	100	200
600 V	14	18	25	50	100

- A-I-Line (see Section 5)
- F = No Lugs (includes terminal nut kit)
- L = Lugs both ends
- M = Lugs "ON" end Terminal Nut Kit "Off" end
- P = Lugs "OFF" end Terminal Nut Kit "On" end
- N = Plug-in ♦
- D = Drawout ♦
- S = Rear Connected ♦

♦ For N, D, and S details see page DE3-45, DE3-41



Accessories - DE3-39
Dimensions - DE3-55
Enclosures - DE3-56

H-Frame 150 A and J-Frame 250 A Electronic Trip CSA/UL Current-Limiting▲ Circuit Breakers (600 Vac) With Factory Sealed Trip Unit■ Suitable for Reverse Connection □

Electronic Trip Unit			Sensor Rating	Interrupting Rating (2nd Letter of Catalog Number)					Terminal
Type	Function	Trip Unit		D	G	J▲	L▲	R▲	
				Catalogue Number▼	Catalogue Number▼	Catalogue Number▼	Catalogue Number▼	Catalogue Number▼	
600 Vac, 50/60 Hz, 3P									
Micrologic Standard	LI	3.2Δ	60 A	HDL36060U31X	HGL36060U31X	HJL36060U31X	HLL36060U31X	HRL36060U31X	AL150HD★
			100 A	HDL36100U31X	HGL36100U31X	HJL36100U31X	HLL36100U31X	HRL36100U31X	
Micrologic Standard	LSI	3.2SΔ	60 A	HDL36060U33X	HGL36060U33X	HJL36060U33X	HLL36060U33X	HRL36060U33X	AL150HD★
			100 A	HDL36100U33X	HGL36100U33X	HJL36100U33X	HLL36100U33X	HRL36100U33X	
Micrologic Ammeter	LSI	5.2A	60 A	HDL36060U43X	HGL36060U43X	HJL36060U43X	HLL36060U43X	HRL36060U43X	AL150HD★
			100 A	HDL36100U43X	HGL36100U43X	HJL36100U43X	HLL36100U43X	HRL36100U43X	
Micrologic Energy	LSI	5.2E	60 A	HDL36060U53X	HGL36060U53X	HJL36060U53X	HLL36060U53X	HRL36060U53X	AL150HD★
			100 A	HDL36100U53X	HGL36100U53X	HJL36100U53X	HLL36100U53X	HRL36100U53X	
Micrologic Ammeter	LSIG	6.2A	60 A	HDL36060U44X	HGL36060U44X	HJL36060U44X	HLL36060U44X	HRL36060U44X	AL150HD★
			100 A	HDL36100U44X	HGL36100U44X	HJL36100U44X	HLL36100U44X	HRL36100U44X	
Micrologic Energy	LSIG	6.2E	60 A	HDL36060U54X	HGL36060U54X	HJL36060U54X	HLL36060U54X	HRL36060U54X	AL150HD★
			100 A	HDL36100U54X	HGL36100U54X	HJL36100U54X	HLL36100U54X	HRL36100U54X	
			250 A	JDL36250U31X	JGL36250U31X	JJL36250U31X	JLL36250U31X	JRL36250U31X	AL250JD▼

- ▲ Circuit breakers with J, L, and R interrupting ratings are CSA/UL certified as current limiting.
- Refer to catalogue 0611CT1001 for circuit breakers with field-interchangeable trip units
- ◆ For 100% rated circuit breakers, add a "C" in the 9th character place (for example, HGL36150CU31X, JGL36250CU43X) 100% rated H- and J-frame circuit breakers have copper lugs and can only be used with copper wire.
- ★ AL150HD wire range is 14–3/0 AWG Al or Cu.
- ▼ AL250JD wire range is 3/0 AWG–350 kcmil Al or Cu. For smaller wire range (4–4/0 AWG Al or Cu), replace the lug's wire binding screws with the larger binding screws provided.
- △ 3P circuit breakers with this trip unit can be used for 2P applications.
- For applications requiring communications see page DE3-49.

H- and J-Frame Termination Options

Termination Letter	Description
A	I-Line (See Section 5)
F	No Lugs (includes terminal nut kit on both ends)
L	Lugs both ends
M	Lugs ON end Terminal Nut Kit OFF end
P	Lugs OFF end Terminal Nut Kit ON end
N	Plug-in ◆
D	Drawout ◆
S	Rear Connected ◆

For factory-installed termination, place termination letter in the third block of the circuit breaker catalog number.

HDL36015T

Termination Letter

◆ For N and D details, refer to page DE3-45. For S details, refer to page DE3-41.



H-Frame Micrologic™ Trip Unit

H- and J-Frame Interrupting Ratings

Voltage	Interrupting Rating				
	D	G	J	L	R
240 Vac	25 kA	65 kA	100 kA	125 kA	200 kA
480 Vac	18 kA	35 kA	65 kA	100 kA	200 kA
600 Vac	14 kA	18 kA	25 kA	50 kA	100 kA



J-Frame Micrologic™ Trip Unit

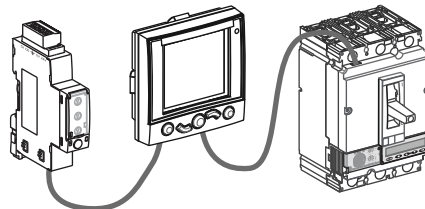

H-Frame Circuit Breaker with Optional FDM and IFM Modules

- Accessories Page DE3-39
- Optional Lugs Page DE3-42
- Dimensions Page DE3-55
- Enclosures Page DE3-56

DE3 CIRCUIT BREAKERS

PowerPact™ Circuit Breaker

Q-Frame Circuit Breakers

Class 0734 / Refer to Catalogs: 0734CT0201



QBL 2P
70–250 A



QBL 3P
70–250 A

POWERPACT Q-frame—250 A, Thermal-magnetic Circuit Breaker (240 Vac)

Ampere Rating	AC Magnetic Trip Settings		B Interrupting	D Interrupting	G Interrupting	J Interrupting ★	Terminal Wire Range ■
	Hold	Trip	Catalogue Number	Catalogue Number	Catalogue Number	Catalogue Number	
2-pole, 240 Vac							
70	1000	1800	QBL22070	QDL22070	QGL22070	QJL22070	#4 AWG - 300 kcmil Al/Cu
80	1000	1800	QBL22080	QDL22080	QGL22080	QJL22080	
90	1000	1800	QBL22090	QDL22090	QGL22090	QJL22090	
100	1200	2400	QBL22100	QDL22100	QGL22100	QJL22100	
110	1200	2400	QBL22110	QDL22110	QGL22110	QJL22110	
125	1200	2400	QBL22125	QDL22125	QGL22125	QJL22125	
150	1200	2400	QBL22150	QDL22150	QGL22150	QJL22150	
175	1200	2400	QBL22175	QDL22175	QGL22175	QJL22175	
200	1200	2400	QBL22200	QDL22200	QGL22200	QJL22200	
225	1200	2400	QBL22225	QDL22225	QGL22225	QJL22225	
250	1200	2400	QBL22250■	QDL22250■	QGL22250■	QJL22250■	
3-pole, 240 Vac							
70	1000	1800	QBL32070	QDL32070	QGL32070	QJL32070	#4 AWG - 300 kcmil Al/Cu
80	1000	1800	QBL32080	QDL32080	QGL32080	QJL32080	
90	1000	1800	QBL32090	QDL32090	QGL32090	QJL32090	
100	1200	2400	QBL32100	QDL32100	QGL32100	QJL32100	
110	1200	2400	QBL32110	QDL32110	QGL32110	QJL32110	
125	1200	2400	QBL32125	QDL32125	QGL32125	QJL32125	
150	1200	2400	QBL32150	QDL32150	QGL32150	QJL32150	
175	1200	2400	QBL32175	QDL32175	QGL32175	QJL32175	
200	1200	2400	QBL32200	QDL32200	QGL32200	QJL32200	
225	1200	2400	QBL32225	QDL32225	QGL32225	QJL32225	
250	1200	2400	QBL32250■	QDL32250■	QGL32250■	QJL32250■	

▲ Replacement lugs and electrical accessories are not available for POWERPACT Q-frame circuit breakers.

- 250 A lugs are suitable for copper conductors only.
- Refer to Catalogue 0734CT0201 for details.

Q-Frame Termination Options

Termination Letter	
A = I-Line (See Section 5)	For factory-installed termination, place termination letter in the third block of the circuit breaker catalog number. QGL32200 Termination Letter
E = Bolt-on I-Line (See Section 5)	
F = No lugs	
L = Lugs both ends	
M = Lugs ON end, studs on OFF end	
P = Lugs OFF end, studs on ON end	
– Add TS suffix for studs on both ends without nuts and washers. See Catalogue 0734CT0201 for additional information.	

Q-Frame Interrupting Ratings (kA)

Voltage	QB	QD	QG	QJ
240 V	10	25	65	100★
480 V
600 V

★ 3-pole QJ circuit breakers are rated at 208Y/120 Vac only.

Dimensions DE3-55
Enclosures DE3-56

DE3 CIRCUIT BREAKERS

PowerPact™ Circuit Breakers

L-Frame Circuit Breakers

Class 611 / Refer to Catalogs: 0611CT1001

L-Frame 600 A Circuit Breakers with Lugs and Factory-Sealed Electronic Trip Units Suitable for Reverse Connection Δ *

Electronic Trip Unit			Sensor Rating	Interrupting Rating (2nd Letter of Catalog Number)					Terminal
Type	Function	Trip Unit		D	G	J \diamond	L \diamond	R \diamond	
				Catalogue Number \square	Catalogue Number \square	Catalogue Number \square	Catalogue Number \square	Catalogue Number \square	
Micrologic Standard	LI	3.3 \star	250 A	LDL36250U31X	LGL36250U31X	LJL36250U31X	LLL36250U31X	LRL36250U31X	AL400L61K3 ∇
			400 A	LDL36400U31X	LGL36400U31X	LJL36400U31X	LLL36400U31X	LRL36400U31X	AL600LS52K3 \circ
			600 A	LDL36600U31X	LGL36600U31X	LJL36600U31X	LLL36600U31X	LRL36600U31X	
Micrologic Standard	LSI	3.3S \star	250 A	LDL36250U33X	LGL36250U33X	LJL36250U33X	LLL36250U33X	LRL36250U33X	AL400L61K3 ∇
			400 A	LDL36400U33X	LGL36400U33X	LJL36400U33X	LLL36400U33X	LRL36400U33X	AL600LS52K3 \circ
			600 A	LDL36600U33X	LGL36600U33X	LJL36600U33X	LLL36600U33X	LRL36600U33X	
Micrologic Ammeter	LSI	5.3A	400 A	LDL36400U43X	LGL36400U43X	LJL36400U43X	LLL36400U43X	LRL36400U43X	AL600LS52K3 \circ
Micrologic Energy	LSI	5.3E	400 A	LDL36400U53X	LGL36400U53X	LJL36400U53X	LLL36400U53X	LRL36400U53X	
Micrologic Ammeter	LSIG	6.3A	400 A	LDL36400U44X	LGL36400U44X	LJL36400U44X	LLL36400U44X	LRL36400U44X	
Micrologic Energy	LSIG	6.3E	400 A	LDL36400U54X	LGL36400U54X	LJL36400U54X	LLL36400U54X	LRL36400U54X	
600 Vac, 50/60 Hz, 4P									
Micrologic Standard	LI	3.3	250 A	LDL46250U31X	LGL46250U31X	LJL46250U31X	LLL46250U31X	LRL46250U31X	AL400L61K4 ∇
			400 A	LDL46400U31X	LGL46400U31X	LJL46400U31X	LLL46400U31X	LRL46400U31X	AL600LS52K4 \circ
			600 A	LDL46600U31X	LGL46600U31X	LJL46600U31X	LLL46600U31X	LRL46600U31X	
Micrologic Standard	LSI	3.3S	250 A	LDL46250U33X	LGL46250U33X	LJL46250U33X	LLL46250U33X	LRL46250U33X	AL400L61K4 ∇
			400 A	LDL46400U33X	LGL46400U33X	LJL46400U33X	LLL46400U33X	LRL46400U33X	AL600LS52K4 \circ
			600 A	LDL46600U33X	LGL46600U33X	LJL46600U33X	LLL46600U33X	LRL46600U33X	
Micrologic Ammeter	LSI	5.3A	400 A	LDL46400U43X	LGL46400U43X	LJL46400U43X	LLL46400U43X	LRL46400U43X	AL600LS52K4 \circ
Micrologic Energy	LSI	5.3E	400 A	LDL46400U53X	LGL46400U53X	LJL46400U53X	LLL46400U53X	LRL46400U53X	
Micrologic Ammeter	LSIG	6.3A	400 A	LDL46400U44X	LGL46400U44X	LJL46400U44X	LLL46400U44X	LRL46400U44X	
Micrologic Energy	LSIG	6.3E	400 A	LDL46400U54X	LGL46400U54X	LJL46400U54X	LLL46400U54X	LRL46400U54X	

- Δ Refer to catalogue 0611CT1001 for circuit breakers with field-interchangeable trip units
- \square For 100% rated circuit breakers (250 A and 400 A only), add a "C" in the 9th character place (for example, LGL36400CU31X)
- \diamond Circuit breakers with J, L, and R interrupting ratings are CSA/UL certified as current limiting.
- \star 3P circuit breakers with this trip unit can be used for 2P applications.
- ∇ AL400L61K3 terminal wire ranges are (1) 2 AWG–600 kcmil Cu or 1) 2 AWG–500 kcmil Al.
- \circ AL600LS52K3 terminal wire range is (2) 2/0 AWG–500 kcmil Al/Cu.
- \ast For applications requiring communications see page DE3-49.

DE3 CIRCUIT BREAKERS



L-Frame Circuit Breaker

Termination Options

Termination Letter	Termination Option
A	I-Line (See Section 5)
F	No lugs
L	Lugs both ends
M	Lugs ON end, terminal nut kit OFF end
P	Lugs OFF end, terminal nut kit ON end
N \diamond	Plug In
D \diamond	Drawout
S \diamond	Rear Connected

For factory-installed termination, place termination letter in the third block of the circuit breaker catalog number.

LGL36600U44X
└─ Termination Letter

- \diamond For N and D details, please refer to page DE3-45. For S details, please refer to page DE3-41.

Interrupting Ratings

Voltage	Interrupting Rating				
	D	G	J	L	R
240 Vac	25 kA	65 kA	100 kA	125 kA	200 kA
480 Vac	18 kA	35 kA	65 kA	100 kA	200 kA
600 Vac	14 kA	18 kA	25 kA	50 kA	100 kA

- Accessories page DE3-39
- Optional Lugs page DE3-42
- Dimensions page DE3-55
- Enclosures page DE3-56

PowerPact™ Circuit Breakers

M-Frame Circuit Breakers

Class 612 / Refer to Catalog 0612CT0101



M-Frame Circuit Breaker

Frame—800 A, Standard Rated, Basic Electronic Trip System Type ET 1.0 ◦Factory Sealed Trip Unit

Ampere Rating	Adjustable Instantaneous Trip Range		G Interrupting	J Interrupting		Terminal Wire Range
	Low	High	Catalogue Number	Catalogue Number	Price	
2-pole, 600 Vac 50/60 Hz						
300	600	3000	MGL26300	MJL26300		AL800M23K 3-3/0 through 500 kcmil Al/Cu
350	700	3500	MGL26350	MJL26350		
400	800	4000	MGL26400	MJL26400		
450	900	4500	MGL26450	MJL26450		
500	1000	5000	MGL26500	MJL26500		
600	1200	6000	MGL26600	MJL26600		
700	1400	7000	MGL26700	MJL26700		
800	1600	8000	MGL26800	MJL26800		
3-pole, 600 Vac 50/60 Hz						
300	600	3000	MGL36300	MJL36300		AL800M23K 3-3/0 through 500 kcmil Al/Cu
350	700	3500	MGL36350	MJL36350		
400	800	4000	MGL36400	MJL36400		
450	900	4500	MGL36450	MJL36450		
500	1000	5000	MGL36500	MJL36500		
600	1200	6000	MGL36600	MJL36600		
700	1400	7000	MGL36700	MJL36700		
800	1600	8000	MGL36800	MJL36800		

- The ET 1.0 trip unit cannot be field replaced or have the long-time trip point setting adjusted. It is considered an electronic equivalent of a thermal-magnetic circuit breaker.

Termination Options

Termination Letter	Termination Option
A	I-Line (See Section 5)
F	No lugs
L	Lugs both ends
M	Lugs ON end, terminal nut kit OFF end
P	Lugs OFF end, terminal nut kit ON end

For factory-installed termination, place termination letter in the third block of the circuit breaker catalog number.

MGL36400
 L Termination Letter

M-Frame Interrupting Ratings (kA)

Voltage	G	J
240 V	65	100
480 V	35	65
600 V	18	25

Accessories page DE3-39
 Optional Lugs page DE3-42
 Dimensions page DE3-55
 Enclosures page DE3-56

P Frame - 1200A, (600 Vac, 50/60 Hz) 3P ▲ Circuit Breaker with Electronic Trip Unit

Electronic Trip Unit			Sensor Rating	G Interrupting		J Interrupting		L Interrupting		K Interrupting		Terminal Wire Range
Type	Function	Trip Unit		Catalogue Number	Catalogue Number	Catalogue Number	Price	Catalogue Number	Catalogue Number			
Basic Electronic Trip Unit (Not Interchangeable)	Fixed long-time, Adjustable Instantaneous	ET1.0I	600 A	PGL36060	PJL36060	PLL34060		PKL36060	AL800M23K			
			800 A	PGL36080	PJL36080	PLL34080		PKL36080	(3) 3/0 AWG-500 kcmil Al or Cu			
Micrologic Interchangeable Standard Trip Unit	LI	3.0	1000 A	PGL36100	PJL36100	PLL34100		PKL36100	AL1200P25K			
			1200 A	PGL36120	PJL36120	PLL34120		PKL36120	(4) 3/0 AWG-500 kcmil Al or Cu			
			250	PGL36025U31A	PJL36025U31A	PLL34025U31A		PKL36025U31A	(3) 3/0 AWG-500 kcmil Al or Cu			
			400	PGL36040U31A	PJL36040U31A	PLL34040U31A		PKL36040U31A				
			600	PGL36060U31A	PJL36060U31A	PLL34060U31A		PKL36060U31A				
			800	PGL36080U31A	PJL36080U31A	PLL34080U31A		PKL36080U31A				
	1000	PGL36100U31A	PJL36100U31A	PLL34100U31A		PKL36100U31A						
	1200	PGL36120U31A	PJL36120U31A	PLL34120U31A		PKL36120U31A						
	LSI	5.0	250	PGL36025U33A	PJL36025U33A	PLL34025U33A		PKL36025U33A	(3) 3/0 AWG-500 kcmil Al or Cu			
			400	PGL36040U33A	PJL36040U33A	PLL34040U33A		PKL36040U33A				
			600	PGL36060U33A	PJL36060U33A	PLL34060U33A		PKL36060U33A				
			800	PGL36080U33A	PJL36080U33A	PLL34080U33A		PKL36080U33A				
1000			PGL36100U33A	PJL36100U33A	PLL34100U33A		PKL36100U33A					
1200			PGL36120U33A	PJL36120U33A	PLL34120U33A		PKL36120U33A					
Micrologic Interchangeable Ammeter Trip Unit	LI	3.0A	250	PGL36025U41A	PJL36025U41A	PLL34025U41A		PKL36025U41A	(3) 3/0 AWG-500 kcmil Al or Cu			
			400	PGL36040U41A	PJL36040U41A	PLL34040U41A		PKL36040U41A				
			600	PGL36060U41A	PJL36060U41A	PLL34060U41A		PKL36060U41A				
			800	PGL36080U41A	PJL36080U41A	PLL34080U41A		PKL36080U41A				
			1000	PGL36100U41A	PJL36100U41A	PLL34100U41A		PKL36100U41A				
			1200	PGL36120U41A	PJL36120U41A	PLL34120U41A		PKL36120U41A				
	LSI	5.0A	250	PGL36025U43A	PJL36025U43A	PLL34025U43A		PKL36025U43A	(3) 3/0 AWG-500 kcmil Al or Cu			
			400	PGL36040U43A	PJL36040U43A	PLL34040U43A		PKL36040U43A				
			600	PGL36060U43A	PJL36060U43A	PLL34060U43A		PKL36060U43A				
			800	PGL36080U43A	PJL36080U43A	PLL34080U43A		PKL36080U43A				
			1000	PGL36100U43A	PJL36100U43A	PLL34100U43A		PKL36100U43A				
			1200	PGL36120U43A	PJL36120U43A	PLL34120U43A		PKL36120U43A				
LSIG	6.0A	250	PGL36025U44A	PJL36025U44A	PLL34025U44A		PKL36025U44A	(3) 3/0 AWG-500 kcmil Al or Cu				
		400	PGL36040U44A	PJL36040U44A	PLL34040U44A		PKL36040U44A					
		600	PGL36060U44A	PJL36060U44A	PLL34060U44A		PKL36060U44A					
		800	PGL36080U44A	PJL36080U44A	PLL34080U44A		PKL36080U44A					
		1000	PGL36100U44A	PJL36100U44A	PLL34100U44A		PKL36100U44A					
		1200	PGL36120U44A	PJL36120U44A	PLL34120U44A		PKL36120U44A					
Micrologic Interchangeable Power Trip Unit	LSI	5.0P	250	PGL36025U63AE1	PJL36025U63AE1	PLL34025U63AE1		PKL36025U63AE1	(3) 3/0 AWG-500 kcmil Al or Cu			
			400	PGL36040U63AE1	PJL36040U63AE1	PLL34040U63AE1		PKL36040U63AE1				
			600	PGL36060U63AE1	PJL36060U63AE1	PLL34060U63AE1		PKL36060U63AE1				
			800	PGL36080U63AE1	PJL36080U63AE1	PLL34080U63AE1		PKL36080U63AE1				
			1000	PGL36100U63AE1	PJL36100U63AE1	PLL34100U63AE1		PKL36100U63AE1				
			1200	PGL36120U63AE1	PJL36120U63AE1	PLL34120U63AE1		PKL36120U63AE1				
	LSIG	6.0P	250	PGL36025U64AE1	PJL36025U64AE1	PLL34025U64AE1		PKL36025U64AE1	(3) 3/0 AWG-500 kcmil Al or Cu			
			400	PGL36040U64AE1	PJL36040U64AE1	PLL34040U64AE1		PKL36040U64AE1				
			600	PGL36060U64AE1	PJL36060U64AE1	PLL34060U64AE1		PKL36060U64AE1				
			800	PGL36080U64AE1	PJL36080U64AE1	PLL34080U64AE1		PKL36080U64AE1				
			1000	PGL36100U64AE1	PJL36100U64AE1	PLL34100U64AE1		PKL36100U64AE1				
			1200	PGL36120U64AE1	PJL36120U64AE1	PLL34120U64AE1		PKL36120U64AE1				
Micrologic Interchangeable Harmonic Trip Unit	LSI	5.0H	250	PGL36025U73AE1	PJL36025U73AE1	PLL34025U73AE1		PKL36025U73AE1	(3) 3/0 AWG-500 kcmil Al or Cu			
			400	PGL36040U73AE1	PJL36040U73AE1	PLL34040U73AE1		PKL36040U73AE1				
			600	PGL36060U73AE1	PJL36060U73AE1	PLL34060U73AE1		PKL36060U73AE1				
			800	PGL36080U73AE1	PJL36080U73AE1	PLL34080U73AE1		PKL36080U73AE1				
			1000	PGL36100U73AE1	PJL36100U73AE1	PLL34100U73AE1		PKL36100U73AE1				
			1200	PGL36120U73AE1	PJL36120U73AE1	PLL34120U73AE1		PKL36120U73AE1				
	LSIG	6.0H	250	PGL36025U74AE1	PJL36025U74AE1	PLL34025U74AE1		PKL36025U74AE1	(3) 3/0 AWG-500 kcmil Al or Cu			
			400	PGL36040U74AE1	PJL36040U74AE1	PLL34040U74AE1		PKL36040U74AE1				
			600	PGL36060U74AE1	PJL36060U74AE1	PLL34060U74AE1		PKL36060U74AE1				
			800	PGL36080U74AE1	PJL36080U74AE1	PLL34080U74AE1		PKL36080U74AE1				
			1000	PGL36100U74AE1	PJL36100U74AE1	PLL34100U74AE1		PKL36100U74AE1				
			1200	PGL36120U74AE1	PJL36120U74AE1	PLL34120U74AE1		PKL36120U74AE1				

- ▲ For 2P and 4P information see Catalog 0612CT0101.
- For 100% rated circuit breakers add a "C" in the 9th character place. For example, the catalog number for a 100% trip unit with LI trip functions at 250A would be PGL36025CU31A. 100% ratings are not available for circuit breakers with ET1.0 Trip Units.
- ◆ P-frame L-interrupting is available in 480 Vac only.

P-Frame Termination Options

Termination Letter	
F = No Lugs (Includes terminal nut kit on both ends)	For factory-installed termination, place termination letter in the third block of the circuit breaker catalog number.
L = Lugs both ends	
M = Lugs ON end, terminal nut kit OFF end	
P = Lugs OFF end, terminal nut kit ON end	
D = Drawout	
A = I-Line (See Section 5)	

PGL36040U41A
 L Termination Letter

P-Frame and R-Frame Interrupting Ratings

Voltage	P-Frame Interrupting Rating				R-Frame Interrupting Rating			
	G	J	K	L	G	J	K	L
240 Vac	65 kA	100 kA	65 kA	125 kA	65 kA	100 kA	65 kA	125 kA
480 Vac	35 kA	65 kA	50 kA	100 kA	35 kA	65 kA	65 kA	100 kA
600 Vac	18 kA	25 kA	50 kA		18 kA	25 kA	65 kA	50 kA

- R-frame catalog numbers Page DE3-28
- Dimensions Page DE3-55
- Trip Unit Options Page DE3-47
- Optional Lugs Page DE3-42
- Alternate Rating Plugs Page DE3-48
- Enclosure Page DE3-56
- Accessories Page DE3-39

DE3 CIRCUIT BREAKERS

PowerPact™ Circuit Breakers

R-Frame Circuit Breakers

Class 612 / Refer to Catalog 0612CT0101

R-frame—3000 A (600 Vac, 50/60 Hz) 3P Δ Circuit Breaker with Electronic Trip Unit

Electronic Trip Unit			Sensor Rating	G Interrupting \blacklozenge	J Interrupting \blacklozenge	L Interrupting \blacklozenge	K Interrupting \blacklozenge
Type	Function	Trip Unit		Catalogue Number \blacksquare	Catalogue Number \blacksquare	Catalogue Number \blacksquare	Catalogue Number \blacksquare
Basic Electronic Trip Unit (Not Interchangeable)	Fixed long-time, Adjustable Instantaneous	ET1.0I	1200 A	RGF36120	RJF36120	RLF36120	RKF36120
			1600 A	RGF36160	RJF36160	RLF36160	RKF36160
			2000 A	RGF36200	RJF36200	RLF36200	RKF36200
			2500 A	RGF36250	RJF36250	RLF36250	RKF36250
Micrologic Interchangeable Standard Trip Unit	LI	3.0	600	RGF36060U31A	RJF36060U31A	RLF36060U31A	RKF36060U31A
			800	RGF36080U31A	RJF36080U31A	RLF36080U31A	RKF36080U31A
			1000	RGF36100U31A	RJF36100U31A	RLF36100U31A	RKF36100U31A
			1200	RGF36120U31A	RJF36120U31A	RLF36120U31A	RKF36120U31A
			1600	RGF36160U31A	RJF36160U31A	RLF36160U31A	RKF36160U31A
			2000	RGF36200U31A	RJF36200U31A	RLF36200U31A	RKF36200U31A
	LSI	5.0	2500	RGF36250U31A	RJF36250U31A	RLF36250U31A	RKF36250U31A
			3000	RGF36300U31A	RJF36300U31A	RLF36300U31A	RKF36300U31A
			600	RGF36060U33A	RJF36060U33A	RLF36060U33A	RKF36060U33A
			800	RGF36080U33A	RJF36080U33A	RLF36080U33A	RKF36080U33A
			1000	RGF36100U33A	RJF36100U33A	RLF36100U33A	RKF36100U33A
			1200	RGF36120U33A	RJF36120U33A	RLF36120U33A	RKF36120U33A
Micrologic Interchangeable Ammeter Trip Unit	LI	3.0A	1600	RGF36160U41A	RJF36160U41A	RLF36160U41A	RKF36160U41A
			2000	RGF36200U41A	RJF36200U41A	RLF36200U41A	RKF36200U41A
			2500	RGF36250U41A	RJF36250U41A	RLF36250U41A	RKF36250U41A
			3000	RGF36300U41A	RJF36300U41A	RLF36300U41A	RKF36300U41A
			600	RGF36060U43A	RJF36060U43A	RLF36060U43A	RKF36060U43A
			800	RGF36080U43A	RJF36080U43A	RLF36080U43A	RKF36080U43A
	LSI	5.0A	1000	RGF36100U43A	RJF36100U43A	RLF36100U43A	RKF36100U43A
			1200	RGF36120U43A	RJF36120U43A	RLF36120U43A	RKF36120U43A
			1600	RGF36160U43A	RJF36160U43A	RLF36160U43A	RKF36160U43A
			2000	RGF36200U43A	RJF36200U43A	RLF36200U43A	RKF36200U43A
			2500	RGF36250U43A	RJF36250U43A	RLF36250U43A	RKF36250U43A
			3000	RGF36300U43A	RJF36300U43A	RLF36300U43A	RKF36300U43A
LSIG	6.0A	600	RGF36060U44A	RJF36060U44A	RLF36060U44A	RKF36060U44A	
		800	RGF36080U44A	RJF36080U44A	RLF36080U44A	RKF36080U44A	
		1000	RGF36100U44A	RJF36100U44A	RLF36100U44A	RKF36100U44A	
		1200	RGF36120U44A	RJF36120U44A	RLF36120U44A	RKF36120U44A	
		1600	RGF36160U44A	RJF36160U44A	RLF36160U44A	RKF36160U44A	
		2000	RGF36200U44A	RJF36200U44A	RLF36200U44A	RKF36200U44A	
Micrologic Interchangeable Power Trip Unit	LSI	5.0P	2500	RGF36250U63AE1	RJF36250U63AE1	RLF36250U63AE1	RKF36250U63AE1
			3000	RGF36300U63AE1	RJF36300U63AE1	RLF36300U63AE1	RKF36300U63AE1
			600	RGF36060U64AE1	RJF36060U64AE1	RLF36060U64AE1	RKF36060U64AE1
			800	RGF36080U64AE1	RJF36080U64AE1	RLF36080U64AE1	RKF36080U64AE1
			1000	RGF36100U64AE1	RJF36100U64AE1	RLF36100U64AE1	RKF36100U64AE1
			1200	RGF36120U64AE1	RJF36120U64AE1	RLF36120U64AE1	RKF36120U64AE1
	LSIG	6.0P	1600	RGF36160U64AE1	RJF36160U64AE1	RLF36160U64AE1	RKF36160U64AE1
			2000	RGF36200U64AE1	RJF36200U64AE1	RLF36200U64AE1	RKF36200U64AE1
			2500	RGF36250U64AE1	RJF36250U64AE1	RLF36250U64AE1	RKF36250U64AE1
			3000	RGF36300U64AE1	RJF36300U64AE1	RLF36300U64AE1	RKF36300U64AE1
			600	RGF36060U73AE1	RJF36060U73AE1	RLF36060U73AE1	RKF36060U73AE1
			800	RGF36080U73AE1	RJF36080U73AE1	RLF36080U73AE1	RKF36080U73AE1
Micrologic Interchangeable Harmonic Trip Unit	LSI	5.0H	1000	RGF36100U73AE1	RJF36100U73AE1	RLF36100U73AE1	RKF36100U73AE1
			1200	RGF36120U73AE1	RJF36120U73AE1	RLF36120U73AE1	RKF36120U73AE1
			1600	RGF36160U73AE1	RJF36160U73AE1	RLF36160U73AE1	RKF36160U73AE1
			2000	RGF36200U73AE1	RJF36200U73AE1	RLF36200U73AE1	RKF36200U73AE1
			2500	RGF36250U73AE1	RJF36250U73AE1	RLF36250U73AE1	RKF36250U73AE1
			3000	RGF36300U73AE1	RJF36300U73AE1	RLF36300U73AE1	RKF36300U73AE1
	LSIG	6.0H	600	RGF36060U74AE1	RJF36060U74AE1	RLF36060U74AE1	RKF36060U74AE1
			800	RGF36080U74AE1	RJF36080U74AE1	RLF36080U74AE1	RKF36080U74AE1
			1000	RGF36100U74AE1	RJF36100U74AE1	RLF36100U74AE1	RKF36100U74AE1
			1200	RGF36120U74AE1	RJF36120U74AE1	RLF36120U74AE1	RKF36120U74AE1
			1600	RGF36160U74AE1	RJF36160U74AE1	RLF36160U74AE1	RKF36160U74AE1
			2000	RGF36200U74AE1	RJF36200U74AE1	RLF36200U74AE1	RKF36200U74AE1
2500	RGF36250U74AE1	RJF36250U74AE1	RLF36250U74AE1	RKF36250U74AE1			
3000	RGF36300U74AE1	RJF36300U74AE1	RLF36300U74AE1	RKF36300U74AE1			

Note: R-frame circuit breakers can be bus- or cable-connected. For cable connections, optional terminal pad kit RLTB or equivalent bus structure is required. Each RLTB kit contains terminal pads for one end of the circuit breaker only and has provisions for mounting a maximum of 8 lugs per phase (9 lugs for 3000 A). RLTB kits are included with 2500 A 100% rated circuit breakers. The RL3TB kits are included with the 3000 A, 80% and 100% rated circuit breakers. For other circuit breakers, order terminal pad kit (RLTB) and optional lugs separately. See pages DE3-42–DE3-44.

▲ For 2P and 4P information see Catalog 0612CT0101.

■ Listed catalogue numbers are for 80% rated circuit breakers. For 100% rated circuit breakers add a "C" in the 9th character place. For example, the catalogue number for a 100% standard trip unit with LI trip functions at 2500A would be RGF36250CJ31A. 100% ratings are not available for circuit breakers with ET1.0 Trip Units.

◆ See page DE3-27 for interrupting ratings table.

Motor Circuit Protectors and Motor Protector Circuit Breakers

H-Frame and J-Frame MCP Selector

Class 611 / Refer to Catalog 0611CT1001

Application of PowerPact® H-frame and J-frame Electronic Motor Circuit Protectors (MCP)

Horsepower Rating of Induction-type Squirrel-cage and Wound-rotor Motors 3Ø 60 Hz					NEC Full Load Amperes	PowerPact H-frame and J-frame Electronic MCP	
Starter Size	200 Vac	230 Vac	480 Vac	575 Vac			
00	1/2	1/2	1/2	1/2	0.9 A	HJL36030M71 and HLL36030M71	1/2–10 hp
			3/4	1	1.1 A		
			1	1	1.3 A		
			1	1	1.7 A		
			1	1	2.1 A		
			1	1	2.2 A		
			1	1	2.4 A		
			1	1	2.5 A		
			1	1	2.7 A		
			1	1	3 A		
			1	1	3.2 A		
			1	1	3.4 A		
			1	1	3.7 A		
			1	1	3.9 A		
			0	3/4	3/4		
2	2	4.8 A					
2	2	4.8 A					
2	2	6 A					
2	2	6.1 A					
2	2	6.8 A					
2	2	6.9 A					
2	2	7.6 A					
2	2	7.8 A					
2	2	9 A					
2	2	9.6 A					
2	2	11 A					
2	2	14 A					
2	2	15.2 A					
1	1	1				3	3
			3	3	17.5 A		
			3	3	21 A		
			3	3	22 A		
			3	3	25.3 A		
			3	3	27 A		
			3	3	32 A		
			3	3	32.2 A		
			3	3	34 A		
			3	3	40 A		
			3	3	41 A		
			3	3	42 A		
			3	3	48.3 A		
			3	3	52 A		
			2	1-1/2	1-1/2	5	5
5	5	62 A					
5	5	65 A					
5	5	68 A					
5	5	77 A					
5	5	78.2 A					
5	5	80 A					
5	5	92 A					
5	5	96 A					
5	5	99 A					
5	5	104 A					
5	5	120 A					
5	5	124 A					
5	5	125 A					
3	2	2				7-1/2	7-1/2
			7-1/2	7-1/2	144 A		
			7-1/2	7-1/2	150 A		
			7-1/2	7-1/2	154 A		
			7-1/2	7-1/2	156 A		
			7-1/2	7-1/2	177.1 A		
			7-1/2	7-1/2	180 A		
			7-1/2	7-1/2	192 A		
			7-1/2	7-1/2	192 A		
			7-1/2	7-1/2	221 A		
			7-1/2	7-1/2	240 A		
			7-1/2	7-1/2	240 A		
			7-1/2	7-1/2	248 A		
			7-1/2	7-1/2	248 A		

Shaded area is not covered by J-frame electronic motor circuit protector.

DE3 CIRCUIT BREAKERS



Motor Circuit Protector



Motor Protector Circuit Breaker

Motor Circuit Protectors

Mag-Gard™ Motor Circuit Protectors (MCP) are instantaneous-trip magnetic-only circuit breakers. They have a single adjustment which simultaneously sets the magnetic trip level of each individual pole. Mag-Gard™ circuit breakers comply with CEC/NEC requirements for providing motor circuit protection when installed as part of a UL Listed combination controller having motor overload protection. Interrupting ratings are established for these CSA/UL Recognized Components only when they are used in combination with motor starters with properly sized overload relays and contactors.

All Mag-Gard circuit breakers will accept the same lugs and accessories as equivalent circuit breakers. Mag-Gard circuit breakers are available with I-Line construction. ★ High-interruption (H) construction Mag-Gard circuit breakers (LHL) are also available.

Magnetic Only 3 Pole, 600 Vac, 50/60 Hz—Three Device Solutions■

Ampere Rating	Trip Unit	Adjustable Trip Range (A)	250 Vdc Multiplier	Cat. No.
LAL	400	500–1000 A	High = 1.2 Low = 1.4	LAL3640022M
		750–1600 A		LAL3640028M
		1000–2000 A		LAL3640030M
		1125–2250 A		LAL3640031M
		1250–2500 A		LAL3640032M
		1500–3000 A		LAL3640033M
		1750–3500 A		LAL3640035M
		2000–4000 A		LAL3640036M

For PowerPact L- and P-Frames, an instantaneous-only version of the electronic trip circuit breaker is also available for motor circuit protection. These MCPs comply with CEC/NEC® requirements for providing short-circuit protection when installed as part of a Listed combination controller having motor overload protection.

Magnetic Only 3 Pole, 600 Vac, 50/60 Hz—Three Device Solutions■

Sensor Rating	Trip Unit	Adjustable Trip Range (A)	Interrupting Rating			
			G	J	L	R
			Cat. No.	Cat. No.	Cat. No.	Cat. No.
PowerPact L-Frame★	400	500–1200%	LGL36400M37X	LJL36400M37X	LLL36400M37X	LRL36400M37X
	600	500–1200%	LGL36600M37X	LJL36600M37X	LLL36600M37X	LRL36600M37X
PowerPact PjL, PLL★	600	1200–10000 A	—	PJL36060M68	PLL34060M68	—
	800	1200–10000 A	—	PJL36080M68	PLL34080M68	—
	1000	1500–10000 A	—	PJL36100M69	PLL34100M69	—
	1200	1800–10000 A	—	PJL36120M70	PLL34120M70	—

- ▲ CSA/UL magnetic trip tolerances are -20%/+30% from the nominal values shown.
- Three-device solutions are the traditional solutions: motor circuit protector plus motor starter plus overload relay.
- ◆ 250 Vdc ratings are available. No CSA/UL component recognition
- ★ These electronic magnetic only motor circuit protectors are available with I-Line constructions. Consult the factory.

Motor Protector Circuit Breakers

Motor protection circuit breakers provide built-in thermal and magnetic protection. They are used in two-device motor feeder solutions to provide protection against short-circuits, overloads, and phase unbalance.

H-Frame (150 A), J-Frame (250 A) and L-Frame (600 A) Electronic Trip Motor Protector Circuit Breakers (CSA/UL Ratings)—

Two Device Solutions▼

Electronic Trip Unit Type	Frame	Sensor Rating	Trip Unit	Full Load Amperes Range (FLA)	Isd (x FLA)	Interrupting Rating			
						G	J	L	R
						Cat. No.	Cat. No.	Cat. No.	Cat. No.
Standard△	H-Frame	30	2.2 M	14–25	5-13 x FLA	HGL36030M38X	HJL36030M38X	HLL36030M38X	HRL36030M38X
		50		14–42	5-13 x FLA	HGL36050M38X	HJL36050M38X	HLL36050M38X	HRL36050M38X
		100		30–80	5-13 x FLA	HGL36100M38X	HJL36100M38X	HLL36100M38X	HRL36100M38X
		150		58–130	5-13 x FLA	HGL36150M38X	HJL36150M38X	HLL36150M38X	HRL36150M38X
	L-Frame	250	2.3 M	114–217	5-13 x FLA	JGL36250M38X	JJL36250M38X	JLL36250M38X	JRL36250M38X
		400		190–348	5-13 x FLA	LGL36400M38X	LJL36400M38X	LLL36400M38X	LRL36400M38X
		600		312–520	5-13 x FLA	LGL36600M38X	LJL36600M38X	LLL36600M38X	LRL36600M38X

- ▼ Two-device solutions (these electronic motor protector circuit breakers include short circuit and overload protection)
 - 1 electronic motor circuit protector with a Micrologic 2.2 M plus
 - 1 contactor
- △ The standard trip unit offers Class 5, 10 and 20 and phase unbalance or phase loss protection.

Accessories	Page DE3-39
Optional Lugs	Page DE3-42
Dimensions	Pages DE3-54 and DE3-55
Enclosures	Page DE3-56



Adjustable Instantaneous Trip Circuit Breakers For Single Motor Circuit Protection

Adjustable instantaneous trip circuit breakers are intended for use in combination with motor starters with overload relays for the protection of motor circuits from short circuits. Other specific applications include rectifiers and resistance welders. These C/B's contain a magnetic trip element in each pole with the trip point adjustable from the front. Interrupting ratings are determined by testing the instantaneous trip C/B in combination with a contactor and overload relay. Refer to C.E.C. 28-210.

Select instantaneous trip C/B's as follows:

1. This selection table is suitable for motors with Locked-Rotor Indicating Code Letters as follows;

Horsepower	Motor Code Letters
1/2 or less	A-L
3/4 to 1 1/2	A-K
2 to 3	A-J
5 to 25	A-H
30 to 125	A-G
150 or more	A-F

For other motors order a special thermal-magnetic circuit breaker with magnetic trip settings for the specific motor - specify motor horsepower, voltage, frequency, full load current and code letter or locked rotor current.

- Determine motor HP rating from the motor nameplate.
- Refer to the table at right and select an instantaneous trip C/B with an ampere rating recommended for the HP and voltage involved.
- Select an adjustable trip setting of at least 700%, not to exceed 1300%, of the motor full load amperes. (FLA).
- The 1300% maximum setting may be inadequate for instantaneous trip circuit breakers to withstand current surges typical of the magnetization current of auto-transformer type reduced voltage starters, or open transition wye-delta starters during transfer from "start" to "run", constant HP multi-speed motors, and motors labeled "high efficiency". Select thermal-magnetic circuit breakers from page DE3-5 for those applications.
- Part-winding motors, should have two circuit breakers selected from the above at not more than one half the allowable trip setting for the horsepower rating. The two circuit breakers should operate simultaneously as a disconnecting means.
- Motor full load currents, 1/2 HP thru 200 HP are taken from Table 44 of the C.E.C. & Table 430-150 of the NEC. Above 200 HP from UL 98, Table 18.2. Select wire and circuit breakers on basis of horsepower rather than nameplate full load current for General Motor Applications. **Do not use these values to select overload relay thermal units. See Book CP2 for selection of thermal units when actual full load is not known.** The voltages listed are rated motor voltages. Corresponding nominal system voltages are 200 to 208, 220 to 240, 440 to 480 and 550 to 600 volts.

Based on 1990 CEC Section 28-210 & Table 44, and 1990 NEC Article 430-52 and Table 430-150.

HP Ratings of Induction Type Squirrel-Cage and Wound Rotor Motors				Full Load Amps. (Note7) ▲	Standard MAG-GARD® Circuit Breaker Catalogue No. ■	Magnetic Trip Settings ♦	
Three Phase 60 Hz ac						LO	HI
200 Volts	230 Volts	460 Volts	575 Volts				
5	5	10	15	14	H(L)36030M38X	500%	1300%
				15.2	H(L)36030M38X		
		17	H(L)36030M38X				
7-1/2	7-1/2	15	20	17.5	H(L)36030M38X		
				21	H(L)36030M38X		
		22	H(L)36030M38X				
		25.3	H(L)36030M38X				
10	10	20	25	27	H(L)36050M38X		
				28	H(L)36050M38X		
		30	32	H(L)36050M38X			
		25	32.2	H(L)36050M38X			
15	15	30	40	34	H(L)36050M38X		
				40	H(L)36050M38X		
		40	41	H(L)36050M38X			
		42	42	H(L)36050M38X			
20	20	40	50	48.3	H(L)36100M38X		
				52	H(L)36100M38X		
		54	H(L)36100M38X				
		55	H(L)36100M38X				
75	50	60	250	65	H(L)36100M38X		
				221	L(L)36400M38X		
	100	200	240	L(L)36400M38X			
			242	L(L)36400M38X			
100	125	250	300	248	L(L)36400M38X		
				285	L(L)36400M38X		
		289	L(L)36400M38X				
		302	L(L)36400M38X				
125	150	300	350	312	L(L)36400M38X		
				336	L(L)36400M38X		
		359	L(L)36600M38X				
		360	L(L)36600M38X				
150	200	350	400	361	L(L)36600M38X		
				382	L(L)36600M38X		
		414	L(L)36600M38X				
		472	L(L)36600M38X				
200	400	500	477	L(L)36600M38X			
		480	480	L(L)36600M38X			

- ▲ Motor full-load currents are taken from NEC Table 430.150. Select wire and circuit breakers on basis of horsepower rather than nameplate full-load current per NEC 430.6 (A) for general motor applications. Do not use these values to select overload relay thermal units. The voltages listed are rated motor voltages. Corresponding nominal system voltages are 200-208, 220-240, 440-480 and 550-600 V.
- To complete catalog number, replace the blank with the appropriate rating (G, J, or L). M38X is for standard trip units. For advanced trip units (LCD display, metering and communication, replace with M58X).
- ♦ Only MIN and MAX settings are shown, intermediate settings are available on all circuit breakers.
- ★ See NEC 430.52(A) for circuit breaker settings above 800%.
- ▼ If due to motor starting characteristics, trip settings at the 1300% maximum permitted level are needed, the next size Mag-Gard circuit breaker should be chosen.

Motor Circuit Protectors

Class 601

Motor Protection Selection Tables

Selection Tables for Conductors, Safety Switches and Thermal-Magnetic Circuit Breakers Based on 2005 NEC® Tables 430.147, 430.148 & 430.150



▲ 8 XHHW requires 3/4 in. conduit for 3W.
 ■ 200 V motors are commonly used on 208 V services.
 ◆ Ordinary service for normal starting duty only, acceleration time of 10 sec. or less.
 ★ Heavy service is jogging or plugging duty or cycling load with over 25 starts per hour or over 5 starts per minute. Energy efficient motors are polyphase motors defined in NEMA Standard MG1 and exhibit high starting current.
 ▼ NEC 430.22 for Single Motor, Smaller conductors may be permitted for light duty-cycle service per 430.22 (B) Exception No. 1. DC motors operating from rectified 1Ø power supply will require larger conductors per 430.22 (A) Exception No. 1. For motor-generator arc welders, see 630.11.
 Δ Motor full load currents thru 200 hp are taken from NEC Tables 430.147, 148 and 150. Above 200 hp from UL 98. Select wire size, circuit breakers, or fuses on basis of hp rather than nameplate full load current per NEC 430.6. **Do not use these values to select overload relay thermal units.** Voltages listed are rated motor voltages. Corresponding nominal system voltages are 110–120 V, 200–208 V, 220–240 V, 440–480 V and 550–600 V.
 □ Switch size only is shown in table. Selected fuses should not exceed maximum percent of full-load current as given in NEC Table 430.52. Above 50 hp dc switches are not hp rated by UL as Motor Circuit Switches, but as General Use Switches only and are not necessarily capable of interrupting the max. operating overload current of a motor. See NEC 100 for definition of General Use Switch. When protecting a 3Ø, Design E energy efficient motor, the switch is required by NEC 430.109 to have a hp rating of not less than 1.4 times that of a motor rated 3–100 hp, or not less than 1.3 times that of a motor rated over 100 hp. Switches shown in this table do not necessarily comply with that requirement.
 ◇ Thermal-magnetic circuit breaker ampere ratings recommended are approximate for average conditions, based on trip characteristics of Square D circuit breakers and NEC Table 430.52. Under some conditions, the next size larger switch or circuit breaker rating may be necessary to accommodate the motor starting current and is permitted by NEC 430.52(C)(1) Exception 2. High starting currents are anticipated with Design E and other energy efficient motors. For explanation of Code letter markings, see NEC 430.7(B). For Busway Plug-in units, see Section DEB.
 ★ Thermal-magnetic breaker ampere ratings recommended are approximate for average conditions and based on trip characteristics of Square D circuit breakers and NEC Tables 430.7(B) and 430.52.
 ∇ Type LC, LI, LX, LXI, and LE circuit breakers are NOT recommended for use on single motor branch circuits.
Contact your local Field Office for circuit breaker selection on constant horsepower multi-speed motors.

Horsepower Ratings										Amperage of Thermal-Magnetic Inverse Time Circuit Breaker			Minimum Size metallic Conduit 75° C, C Wire Field-Installed Sized for 125% FLA			
Squirrel-Cage and Wound-Rotor Motors with Norm. Torque Characteristics Operating at usual Speeds				1Ø 10 Hz ac		Average Direct Current Motors Operating at Base Speed		Full Load Amperage Δ	For Motor Code Letter B to E		For Motor Code Letter F to V★	QMB and Heavy Duty Switch with Time Delay Fuses □	Conduit 3 W			
3Ø 60 Hz				115 Vac	200 Vac	230 Vac	120 Vdc		240 Vdc	Ordinary Service ◆			Heavy Service and Energy Efficient ★	AWG kcmil	THHN THWN XHHW	THW
2	5	7-1/2	1/3	3/4	1	3/4	3.4	2	1	6.9 A	15 A	20 A	30 A	14	1/2 in.	N/A
										7.2 A						
3	7-1/2	10	1/2	1-1/2	2	1-1/2	1-1/2	3	1	7.6 A	20 A	30 A	60 A	8	1/2 in.▲	N/A
										7.8 A						
										7.9 A						
										8.0 A						
										8.5 A						
										9.0 A						
										9.2 A						
										9.5 A						
										9.6 A						
										9.8 A						
5	7-1/2	15	1-1/2	3	2	3	2	5	3	10.0 A	35 A	40 A	100 A	6	3/4 in.	1 in.
										11.0 A						
										11.5 A						
										12.0 A						
										12.2 A						
										13.2 A						
										13.8 A						
										14.0 A						
										15.2 A						
										16.0 A						
7-1/2	20	25	5	7-1/2	5	7-1/2	5	10	7-1/2	17.0 A	40 A	50 A	200 A	4	1 in.	1 in.
										17.5 A						
										19.6 A						
										20.0 A						
										21.0 A						
										22.0 A						
										24.0 A						
										25.0 A						
										25.3 A						
										27.0 A						
10	25	30	3	7-1/2	7-1/2	5	10	25	10	28.0 A	50 A	60 A	400 A	2	1 in.	1-1/4 in.
										29.0 A						
										32.0 A						
										32.2 A						
										34.0 A						
										38.0 A						
										40.0 A						
										41.0 A						
										42.0 A						
										46.0 A						
15	40	50	5	10	10	7-1/2	15	7-1/2	15	48.3 A	60 A	70 A	600 A	1	1-1/4 in.	1-1/2 in.
										50.0 A						
										52.0 A						
										54.0 A						
										55.0 A						
										56.0 A						
										57.5 A						
										58.0 A						
										62.0 A						
										62.1 A						
20	50	60	60	10	10	7-1/2	20	25	20	65.0 A	70 A	80 A	800 A	1/0	1-1/4 in.	1-1/2 in.
										68.0 A						
										72.0 A						
										76.0 A						
										77.0 A						
										78.2 A						
										80.0 A						
										89.0 A						
										92.0 A						
										96.0 A						
25	60	75	7-1/2	10	10	7-1/2	25	40	25	100.0 A	80 A	90 A	1200 A	(2) 3/0	(2) 2-1/2 in.	(2) 2 in.
										104.0 A						
										106.0 A						
										120.0 A						
										124.0 A						
										125.0 A						
										130.0 A						
										140.0 A						
										144.0 A						
										150.0 A						
30	75	100	10	10	10	7-1/2	40	50	40	156.0 A	90 A	100 A	1600 A	(2) 3/0	(2) 2 in.	(2) 2-1/2 in.
										157.3 A						
										173.0 A						
										177.0 A						
										180.0 A						
										192.0 A						
										221.0 A						
										240.0 A						
										242.0 A						
										248.0 A						
40	100	125	150	150	150	7-1/2	50	75	50	285.0 A	100 A	1200 A	600 A	(2) 3/0	(2) 2 in.	(2) 2-1/2 in.
										289.0 A						
										302.0 A						
										312.0 A						
										336.0 A						
										359.0 A						
										360.0 A						
										361.0 A						
										382.0 A						
										414.0 A						
50	125	150	200	200	200	7-1/2	75	100	75	472.0 A	120 A	1400 A	800 A	(2) 3/0	(2) 2-1/2 in.	(2) 2-1/2 in.
										477.0 A						
										480.0 A						
										552.0 A						
										590.0 A						
										602.0 A						
										602.0 A						
										602.0 A						
										602.0 A						
										602.0 A						
602.0 A																

DE3 CIRCUIT BREAKERS

Automatic molded case switches open instantaneously at a factory preset magnetic trip point, calibrated to protect only the molded case switch itself, when it is subjected to high fault currents. The trip point is nonadjustable and provides no overload or low level fault protection.

Molded case switches open when the handle is switched to the OFF position or in response to an auxiliary tripping device such as a shunt trip.

All molded case switches will accept the same lugs and accessories as equivalent thermal-magnetic circuit breakers, with the exception of Q-frame switches which do not have electrical accessories available.

Automatic molded case switches are UL Listed per UL 489 and are CSA Certified.



J-Frame Switch

L-Frame Switch

H-Frame, J-Frame, and L-Frame PowerPact™ Automatic Molded Case Switches, 600 Vac

Circuit Breaker	Poles	Ampere Rating	G Withstand		L Withstand		R Withstand		Terminal	Wire Range
			Cat. No.	Trip Point	Cat. No.	Trip Point	Cat. No.	Trip Point		
H-Frame J-Frame	2	150 A	HGL26000S15▲	2250 A	HLL26000S15	2250 A	—	—	AL150HD	14 AWG–3/0 AWG Al/Cu
		175 A	JGL26000S17	3125 A	JLL26000S17	3125 A	—	—	AL175JD	4–4/0 AWG Al/Cu
		250 A	JGL26000S25	3125 A	JLL26000S25	3125 A	—	—	AL250JD	3/0 AWG–350 kcmil Al/Cu
	3	150 A	HGL36000S15	2250 A	HLL36000S15	2250 A	—	—	AL150HD	14 AWG–3/0 AWG Al/Cu
		175 A	JGL36000S17	3125 A	JLL36000S17	3125 A	JRL36000S17	3125 A	AL175JD	4–4/0 AWG Al/Cu
		250 A	JGL36000S25	3125 A	JLL36000S25	3125 A	JRL36000S25	3125 A	AL250JD	3/0 AWG–350 kcmil Al/Cu
L-Frame	3	400 A	LGL36000S40X	4800 A	LLL36000S40X	4800 A	LRL36000S40X	4800 A	AL150HD	AL600LS2K3
		600 A	LGL36000S60X	6600 A	LLL36000S60X	6600 A	LRL36000S60X	6600 A	AL250JD	(2) 2/0 AWG–500 kcmil Al/Cu
		250 A	LGL46000S40X	4800 A	LLL46000S40X	4800 A	LRL46000S40X	4800 A	AL150HD	AL600LS2K4
	4	400 A	LGL46000S60X	6600 A	LLL46000S60X	6600 A	LRL46000S60X	6600 A	AL250JD	(2) 2/0 AWG–500 kcmil Al/Cu

▲ True 2P device. Others are a 2P in a 3P module.

Q-Frame (240 Vac) PowerPact™ Automatic Molded Case Switches

Circuit Breaker	Poles	Ampere Rating	J Withstand		Wire Range
			Cat. No.	Trip Point	
Q-Frame■	2	225 A	QBL22000S22	4500 A	4 AWG–300 kcmil
	3	225 A	QBL32000S22	4500 A	

■ Withstand rating of 10 kA at 240 Vac.

P-Frame and R-Frame PowerPact™ Automatic Molded Case Switches*, 600 Vac

Frame	Poles	Ampere Rating	J Withstand		K Withstand		L Withstand		Terminal	Wire Range
			Cat. No.	Trip Point	Cat. No.	Trip Point	Cat. No.	Trip Point		
P	2	600 A	PJL26000S60	10 kA	PKL26000S60	24 kA	PLL24000S60◆	10 kA	AL800M23K	(3) 3/0 AWG–500 kcmil Al or Cu
		800 A	PJL26000S80	10 kA	PKL26000S80	24 kA	PLL24000S80◆	10 kA		
		1000 A	PJL26000S10	10 kA	PKL26000S10	24 kA	PLL24000S10◆	10 kA	AL1200P25K	(4) 3/0 AWG–500 kcmil Al or Cu
		1200 A	PJL26000S12	10 kA	PKL26000S12	24 kA	PLL24000S12◆	10 kA		
	3	600 A	PJL36000S60	10 kA	PKL36000S60	24 kA	PLL34000S60◆	10 kA	AL800M23K	(3) 3/0 AWG–500 kcmil Al or Cu
		1000 A	PJL36000S10	10 kA	PKL36000S10	24 kA	PLL34000S10◆	10 kA		
R	2	1200 A	—	—	RKF26000S12	57 kA	RLF26000S12	48 kA	R-frame circuit breakers can be bus-connected or cable-connected. For cable connections, RLTB kit or equivalent bus structure is required. Kit is included with 3000 A switches. For all others, see page DE3-44.	
		1600 A	—	—	RKF26000S16	57 kA	RLF26000S16	48 kA		
		2000 A	—	—	RKF26000S20	57 kA	RLF26000S20	48 kA		
		2500 A	—	—	RKF26000S25	57 kA	RLF26000S25	48 kA		
	3	1200 A	—	—	RKF36000S12	57 kA	RLF36000S12	48 kA		
		1600 A	—	—	RKF36000S16	57 kA	RLF36000S16	48 kA		
		2000 A	—	—	RKF36000S20	57 kA	RLF36000S20	48 kA		
		2500 A	—	—	RKF36000S25	57 kA	RLF36000S25	48 kA		
		3000 A	—	—	RKF36000S30	57 kA	RLF36000S30	48 kA		

◆ P-frame L-interrupting is available in 480 Vac only.

* UL magnetic trip tolerances are -20% / +30% from the nominal values shown.

H-, J-, L-, P-, and R-Frame Withstand Ratings▼

Voltage	Withstand				
	G	J	K	L	R
240 Vac	65 kA	100 kA	65 kA	125 kA	200 kA
480 Vac	35 kA	65 kA	50 kA *	100 kA	200 kA
600 Vac	18 kA	25 kA	50 kA *	50 kA	100 kA

▼ The withstand rating is the fault current at rated voltage that the molded case switch will withstand without damage when protected by a circuit breaker with an equal continuous current rating.

* R-Frame withstand rating is 65kA.

Accessories Page DE3-39
 Optional Lugs Page DE3-42
 Dimensions Pages DE3-54 and DE3-55
 Enclosures Pages DE3-56–DE3-58

The CSA/UL Listed thermal-magnetic molded case circuit breakers shown below are specifically designed for use on ungrounded dc systems having a maximum short-circuit voltage of 500 Vdc or a maximum floating (unloaded) voltage of 600 Vdc. The circuit breakers are suitable for use only with UPS (uninterruptible power supplies) and ungrounded systems.

This two-level voltage rating allows these circuit breakers to be applied to battery sources having a short-circuit availability of 20,000 amperes for LH, and MH circuit breakers and 25,000 amperes for PAF circuit breakers at 500 Vdc.

LH and MH circuit breakers are provided with an adjustable magnetic trip that is readily accessible by means of a single adjustment on the face of the circuit breaker. PAF circuit breakers have a fixed magnetic trip range.

These circuit breakers are CSA/UL Listed for the interrupting ratings shown only if applied with three poles connected in series (series connection is external to circuit breaker). See diagram below.

NOTE: Due to external series connection, I-Line™ circuit breakers are not available for this application.

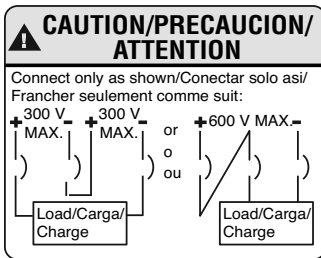

Source = 600 Vdc max. (floating)
500 Vdc max. (loaded)

DC Circuit Breaker Label

DC Molded Case Circuit Breakers

Ampere Rating	Circuit Breaker Cat. No.	Adjustable Magnetic Trip Range—DC Amperes ▲		Interrupting Rating @ 500 Vdc
		Low	High	
100 A	JGL37100D81	400	600	20 k AIR
125 A	JGL37125D81	400	600	
150 A	JGL37150D81	400	600	
175 A	JGL37175D81	400	600	
200 A	JGL37200D82	500	850	
225 A	JGL37225D82	500	850	20 k AIR
250 A	JGL37250D82	500	850	
250 A	LHL3625025DC	625	1250	20 k AIR
300 A	LHL3630026DC	750	1500	
350 A	LHL3635029DC	875	1750	
400 A	LHL3640030DC	1000	2000	
450 A	MHL3645031DC	1125	2250	
500 A	MHL3650032DC	1250	2500	
600 A	MHL3660033DC	1500	3000	
700 A	MHL3670035DC	1750	3500	
800 A	MHL3680036DC	2000	4000	
900 A	MHL3690039DC	2500	5000	
1000 A	MHL36100040DC	2500	5000	25 k AIR
1200 A	MHL36120040DC■	2500	5000	
450 A	MHL3645031DCH	1125	2250	50 k AIR
500 A	MHL3650032DCH	1250	2500	
600 A	MHL3660033DCH	1500	3000	
700 A	MHL3670035DCH	1750	3500	
800 A	MHL3680036DCH	2000	4000	
900 A	MHL3690039DCH	2500	5000	
1000 A	MHL36100040DCH	2500	5000	
1200 A	MHL36120040DCH■	2500	5000	

- ▲ Magnetic trip tolerances are -20%/+30% from the nominal values shown.
- Suitable for use only in a ventilated enclosure. Minimum enclosure dimensions are 38" h x 20" w x 7" d with a minimum of 300 square inches of ventilation near the top and bottom of the enclosure.

Ampere Rating	Circuit Breaker Cat. No.	Fixed Magnetic Trip Range—DC Amperes ▲		Interrupting Rating @ 500 Vdc
		Hold	Trip	
1200 A	PAF361200DC	1200	1620	25 k AIR
1600 A	PAF361600DC	1600	2160	
2000 A	PAF362000DC	2000	2700	
2500 A	PCF362500DC	2500	3375	25 k AIR

Accessories Page DE3-39
 Optional Lugs Page DE3-42
 Dimensions Pages DE3-54 and DE3-55
 Enclosures Pages DE3-56–DE3-58

DE3 CIRCUIT BREAKERS

500 Vdc Circuit Breakers

CSA/UL Listed 500 Vdc NW Circuit Breakers Class 0613DC / Refer to catalog 0613CT0501



Masterpact NW DC Circuit Breaker

CSA/UL Listed Masterpact NW DC circuit breakers are for use on ungrounded systems rated 500 Vdc (600 Vdc unloaded) or less. IEC Rated circuit breakers are for use on ungrounded, grounded middle point, or grounded negative systems. Please refer to catalog 0613CT0501 for details.

DE3 CIRCUIT BREAKERS

Masterpact NW DC Circuit Breakers

Ampere Rating	Circuit Breaker Cat. No.	Interrupting Rating 500 Vdc (max 600 Vdc unloaded)	Fixed Circuit Breaker		Drawout Circuit Breaker		Cradle	
			Version C	Version C1	Version C	Version C1	Version C	Version C1
800 A	NW08NDC	35 kA						
1200 A	NW12NDC	35 kA						
1600 A	NW16NDC	35 kA						
2000A	NW20NDC	35 kA						
2500 A	NW25NDC	35 kA						
3000 A	NW30NDC	35 kA						
4000 A	NW40NDC	35 kA						
800 A	NW08HDC	85 kA						
1200 A	NW12HDC	85 kA						
1600 A	NW16HDC	85 kA						
2000A	NW20HDC	85 kA						
2500 A	NW25HDC	85 kA						
3000 A	NW30HDC	85 kA						
4000 A	NW40HDC	85 kA						

Mission Critical Circuit Breakers

Selective Coordination

208 Y/120 V 3 Phase Panel

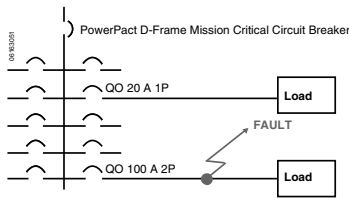

Designed for selectively coordinated systems, mission critical circuit breakers maximize continuity of the electrical service by allowing the branch circuit breaker to clear the fault.

Mission critical circuit breakers are engineered with technology that optimizes current, time and energy selectivity so the fault is cleared by the circuit breaker immediately upstream of the occurrence. This technology (see figure below) allows the remaining areas of the electrical system to continue operation without disruption. In addition to unique design attributes, Square D mission critical circuit breakers have also undergone rigorous testing procedures to certify the coordination with downstream circuit breakers—combining innovative engineering with validated test results.

Apply Square D mission critical circuit breakers in emergency power distribution systems, data centers, hospitals or anywhere continuity of service is desired.

The PowerPact™ J- and L-Frame Mission Critical circuit breakers deliver high levels of selective coordination in a flexible design that can be easily configured for a variety of applications. Tested to be selectively coordinated with the QO™ family of miniature circuit breakers and the ED, EG, and EJ circuit breakers, this solution provides peace of mind when power availability is critical.

An electronic trip unit provides adjustable long-time settings in four sensor sizes, allowing coverage from 70 A through 600 A on a 120–240, 208Y/120, 240, 480Y/277, and 480 V systems.

PowerPact J- and L-Frame Mission Critical Circuit Breakers

Ratings	Available Configurations
UL 489 Listed CSA Certified Voltage: 480 V	I-Line mounting Main circuit breaker in NQ and NF panelboards Unit mount for OEM users Plug-in base for OEM users Drawout base for OEM users

J-Frame 250 A Electronic Trip Mission Critical Circuit Breakers (480/277 Vac) with Factory Sealed Trip Units Suitable for Reverse Connection▲

Electronic Trip Unit Type	Trip Function	Trip Unit	Continuous Current	D Interrupting	G Interrupting	J Interrupting	L Interrupting	Terminal
				Cat. No.	Cat. No.	Cat. No.	Cat. No.	
Standard	LI	3.2 W	250	JDL34250WU31X	JGL34250WU31X	JJL34250WU31X	JLL34250WU31X	AL250JD■
Standard	LSI	3.2S-W	250	JDL34250WU33X	JGL34250WU33X	JJL34250WU33X	JLL34250WU33X	AL250JD■
High Perf. Ammeter	LSI	5.2A-W	250	JDL34250WU43X	JGL34250WU43X	JJL34250WU43X	JLL34250WU43X	AL250JD■
High Perf. Energy	LSI	5.2E-W	250	JDL34250WU53X	JGL34250WU53X	JJL34250WU53X	JLL34250WU53X	AL250JD■
High Perf. Ammeter	LSIG	6.2A-W	250	JDL34250WU44X	JGL34250WU44X	JJL34250WU44X	JLL34250WU44X	AL250JD■
High Perf. Energy	LSIG	6.2E-W	250	JDL34250WU54X	JGL34250WU54X	JJL34250WU54X	JLL34250WU54X	AL250JD■

- ▲ Standard rated (80%). Not available in 100% rated.
- AL250JD terminal wire range is (1) 3/0 AWG–350 kcmil Al or Cu.

L-Frame 600 A Electronic Trip Mission Critical Circuit Breakers (480/277 Vac) with Factory Sealed Trip Units Suitable for Reverse Connection▲

Electronic Trip Unit Type	Trip Function	Trip Unit	Continuous Current	D Interrupting	G Interrupting	J Interrupting	L Interrupting	Terminal
				Cat. No.	Cat. No.	Cat. No.	Cat. No.	
480/277 Vac, 50/60 Hz, 3P								
Standard	LI	3.3 W	250	LDL34250WU31X	LGL34250WU31X	LJL34250WU31X	LLL34250WU31X	AL400L61K3■
			400	LDL34400WU31X	LGL34400WU31X	LJL34400WU31X	LLL34400WU31X	AL600LS52K3◆
Standard	LSI	3.3S-W	250	LDL34250WU33X	LGL34250WU33X	LJL34250WU33X	LLL34250WU33X	AL400L61K3■
			400	LDL34400WU33X	LGL34400WU33X	LJL34400WU33X	LLL34400WU33X	AL600LS52K3◆
High Perf. Ammeter	LSI	5.3A-W	400	LDL34400WU43X	LGL34400WU43X	LJL34400WU43X	LLL34400WU43X	AL600LS52K3◆
			600	LDL34600WU43X	LGL34600WU43X	LJL34600WU43X	LLL34300WU43X	AL600LS52K3◆
High Perf. Energy	LSI	5.3E-W	400	LDL34400WU53X	LGL34400WU53X	LJL34400WU53X	LLL34400WU53X	AL600LS52K3◆
			600	LDL34600WU53X	LGL34600WU53X	LJL34600WU53X	LLL34300WU53X	AL600LS52K3◆
High Perf. Ammeter	LSIG	6.3A-W	400	LDL34400WU44X	LGL34400WU44X	LJL34400WU44X	LLL34400WU44X	AL600LS52K3◆
			600	LDL34600WU44X	LGL34600WU44X	LJL34600WU44X	LLL34300WU44X	AL600LS52K3◆
High Perf. Energy	LSIG	6.3E-W	400	LDL34400WU54X	LGL34400WU54X	LJL34400WU54X	LLL34400WU54X	AL600LS52K3◆
			600	LDL34600WU54X	LGL34600WU54X	LJL34600WU54X	LLL34300WU54X	AL600LS52K3◆
480/277 Vac, 50/60 Hz, 4P								
Standard	LI	3.3 W	250	LDL44250WU31X	LGL44250WU31X	LJL44250WU31X	LLL44250WU31X	AL400L61K4■
			400	LDL44400WU31X	LGL44400WU31X	LJL44400WU31X	LLL44400WU31X	AL600LS52K4◆
Standard	LSI	3.3S-W	250	LDL44250WU33X	LGL44250WU33X	LJL44250WU33X	LLL44250WU33X	AL400L61K4■
			400	LDL44400WU33X	LGL44400WU33X	LJL44400WU33X	LLL44400WU33X	AL600LS52K4◆
High Perf. Ammeter	LSI	5.3A-W	400	LDL44400WU43X	LGL44400WU43X	LJL44400WU43X	LLL44400WU43X	AL600LS52K4◆
			600	LDL44600WU43X	LGL44600WU43X	LJL44600WU43X	LLL44300WU43X	AL600LS52K4◆
High Perf. Energy	LSI	5.3E-W	400	LDL44400WU53X	LGL44400WU53X	LJL44400WU53X	LLL44400WU53X	AL600LS52K4◆
			600	LDL44600WU53X	LGL44600WU53X	LJL44600WU53X	LLL44300WU53X	AL600LS52K4◆
High Perf. Ammeter	LSIG	6.3A-W	400	LDL44400WU44X	LGL44400WU44X	LJL44400WU44X	LLL44400WU44X	AL600LS52K4◆
			600	LDL44600WU44X	LGL44600WU44X	LJL44600WU44X	LLL44300WU44X	AL600LS52K4◆
High Perf. Energy	LSIG	6.3E-W	400	LDL44400WU54X	LGL44400WU54X	LJL44400WU54X	LLL44400WU54X	AL600LS52K4◆
			600	LDL44600WU54X	LGL44600WU54X	LJL44600WU54X	LLL44300WU54X	AL600LS52K4◆

- ▲ 250A and 400A MCCB are 100% rated. 600A MCCB are standard (80%) rated.
- AL400L61K3 terminal wire ranges are (1) #2 AWG–500 kcmil Al or (1) #2 AWG–600 kcmil Cu.
- ◆ AL600LS52K3 terminal wire ranges are (2) 2/0 AWG–500 kcmil Al or Cu.

J-Frame Termination Options

Termination Letter

- A = I-Line (See Section 9)
- F = No Lugs (includes terminal nut kit on both ends)▲
- L = Lugs both ends
- M = Lugs ON end Terminal Nut Kit OFF end
- P = Lugs OFF end Terminal Nut Kit ON end
- N = Plug-in ■
- D = Drawout ■
- S = Rear Connected ■

For factory-installed termination, place termination letter in the third block of the circuit breaker catalog number.

H, G, L, 3, 6, 1, 0, 0

Termination Letter



- ▲ Add TS suffix for circuit breaker without terminal nut kit.
- For N and D termination please refer to page DE3-45. For S termination please refer to page DE3-41.

H- and J-Frame Interrupting Ratings

Voltage	Interrupting Rating			
	D	G	J	L
240 Vac	25 kA	65 kA	100 kA	125 kA
480 Vac	18 kA	35 kA	65 kA	100 kA

Accessories	Page DE3-39
Optional Lugs	Page DE3-42
Dimensions	Page DE3-55
Enclosures	Page DE3-56

Mission Critical Circuit Breakers

Selective Coordination

LA Mission Critical Circuit Breakers

The LA High Magnetic Withstand MC Circuit Breakers are designed to trip at a higher magnetic trip level (18–20 times handle rating) than typical molded case circuit breakers (MCCBs) (which trip at 5–10 times the handle rating).

The high magnetic withstand value of these LA circuit breakers allow the downstream branch circuit breaker to clear the fault.

L-Frame—400 A, Thermal-Magnetic, High Magnetic Withstand Circuit Breakers For Mission Critical Loads





Ampere Rating	AC Magnetic Level Factory Set		Standard Interrupting	High Interrupting	Terminal	
	Hold	Trip	Cat. No.	Cat. No.	Cat. No.	Wire Range
LA/LH MC Circuit Breaker, 3P, 480 Vac						
200 A	3400 A	4000 A	LAL34200MC	LHL34200MC	AL250LAMC	(1) 250–350 kcmil Al (1) 3/0 AWG–350 kcmil Cu
225 A	3825 A	4500 A	LAL34225MC	LHL34225MC		
250 A	4250 A	5000 A	LAL34250MC	LHL34250MC		
400 A	6000 A	7200 A	LAL34400MC	LHL34400MC	AL400LA	(1) 1 AWG–600 kcmil Al or (2) 1 AWG–250 kcmil Al

L-Frame Interrupting Table

	LAL	LHL
240 Vac	42 kA	65 kA
480 Vac	30 kA	35 kA

Dimensions Page DE3-54
Enclosures Page DE3-56

Electrical Accessories

Accessory	Description	Rated Voltage	H-, J-, and L-Frame			M-, P-, and R-Frame				
			Factory-Installed Cat. Suffix	H- and J-Frame	L-Frame	Factory Installed Cat. Suffix	Field-Installable Cat. No.			
				Field-Installable Cat. No.	Field-Installable Cat. No.					
Auxiliary and Alarm Switches (OF, SD, SDE)  H-, J-, L-, M-, P, and R-Frame	Provides circuit breaker contact status. Note: The location of the accessory in the circuit breaker determines its function.	Standard Min Load = 10mA with 24V	1 auxiliary switch (OF) 1a1b	AA	S29450	S29450	AA	S29450		
			2 auxiliary switch (OF) 2a2b	AB	2x S29450	2x S29450	AB	2x S29450		
			3 auxiliary switch (OF) 3a3b	AC	—	3x S29450	AC	3x S29450		
			Alarm Switch (SD) 1a1b	BC	S29450	S29450	BC	S29450		
			Overcurrent trip switch (SDE) 1a1b	BD	—	S29450	BD	S29450		
			Consisting of: OF Switch SDE Adapter	—	S29450	—	—	—		
		Alarm switch and Overcurrent trip switch	BE	—	2x S29450	2x S29450	BE	2x S29450		
		Consisting of: OF Switch SDE Adapter	—	S29450	—	—	—			
		Auxiliary Switch/Alarm Switch/Adapter (OF/SD/SDE) Kit	—	—	—	—	—	S33801■		
		Low Level Min Load = 1mA with 24V	One auxiliary switch (OF) 1a1b	AE	S29452	S29452	AE	S29452		
			Two auxiliary switches (OF) 2a2b	AF	2x S29452	2x S29452	AF	2x S29452		
			3 auxiliary switches (OF) 3a3b	AG	—	3x S29452	AG	3x S29452		
Alarm Switch (SD) 1a1b	BH		S29452	S29452	BH	S29452				
Overcurrent trip switch (SDE) 1a1b	BJ		—	S29452	BJ★	S29452				
Consisting of: OF Switch SDE Adapter	—		S29452	—	—	—				
Alarm switch and Overcurrent trip switch	BK	—	2x S29452	2x S29452	BK★	2x S29452				
Consisting of: OF Switch SDE Adapter♦	—	S29452	—	—	—					
Shunt Trip (MX)  H-, J-, and L-Frame	Trips the circuit breaker from a remote location by means of a trip coil energized from a separate supply voltage circuit.	AC	24	SK	S29384	S29384	SK	S33659		
			48	SL	S29385	S29385	SL	S33660		
			110-130	SA	S29386	S29386	SA	S33661		
			220-240	—	—	—	SC	S33662		
			208-277	SD	S29387	S29387	SD	S33663		
			380-480	SH	S29388	S29388	SH	S33664		
		525-600	SJ	S29389	S29389	—	—			
		DC	12	SN	S29382	S29382	SN	S33658		
			24	SO	S29390	S29390	SK	S33659		
			30	SU	S29391	S29391	SK	S33659		
			48	SP	S29392	S29392	SL	S33660		
			60	SV	S29383	S29383	SL	S33660		
			125	SR	S29393	S29393	SA	S33661		
		250	SS	S29394	S29394	SC	S33662			
		Undervoltage Trip (MN)  H-, J-, and L-Frame	Instantaneously opens the circuit breaker when the under-voltage trip supply voltage drops to a value between 35% and 70% of its rated voltage. Closing is allowed when the supply voltage of the undervoltage trip reaches 85% of rated voltage.	AC	24	UK	S29404	S29404	UK	S33668
					48	UL	S29405	S29405	UL	S33669
					110-130	UA	S29406	S29406	UA	S33670
					220-240	—	—	—	UC	S33671
208-277	UD				S29407	S29407	—	—		
380-480	UH				S29408	S29408	UH	S33673		
525-600	UJ			S29409	S29409	—	—			
DC	12			UN	S29402	S29402	—	—		
	24			UO	S29410	S29410	UK	S33668		
	30			UU	S29411	S29411	UK	S33668		
	48			UP	S29412	S29412	UL	S33669		
	60			UV	S29403	S29403	UL	S33669		
	125			UR	S29413	S29413	UA	S33670		
250	US			S29414	S29414	UC	S33671			
Time Delay Unit 	Undervoltage trip with externally mounted adjustable time delay unit for UVR of 0.5, 0.9, 1.5, 3.0 seconds before circuit breaker trips.			AC/DC	48	—	S33680	S33680	—	S33680▲
					100-130	—	S33681	S33681	—	S33681▲
					220-250	—	S33682	S33682	—	S33682▲
					380-480	—	—	—	—	S33683▲
	Undervoltage trip with externally mounted non-adjustable time delay unit of 0.25 sec before circuit breaker trips.	AC/DC	48	—	S29426	S29426	—	—		
			100-130	—	—	—	—	S33684▲		
			200-250	—	—	—	—	S33685▲		
			220-240	—	S29427	S29427	—	—		

- ▲ Field-installable kit includes time delay module only. Order undervoltage trip separately.
- P-frame drawout circuit breaker only.
- ♦ SDE Adapter used for H- and J-frame only.
- ★ Not available on electrically operated P-frame.

PowerPact™ Circuit Breaker Accessories

Motor Operators and Rotary Handles

Class 0611, 612 / Refer to Catalogs 0611CT1001, 0612CT0101

Motor Operators for H-, J-, and L-Frame Circuit Breakers

Description	Rated Voltage	Factory Installed Cat. No. Suffix	Field-Installable Kit			
			H-Frame ▲	J-Frame	L-Frame 600 A	
			Cat. No.	Cat. No.	Cat. No.	
 <p>Standard motor for electrically-operated circuit breakers ■</p>	AC	48-60	ML	S29440	S31548	S432639
		110-130	MA	S29433	S31540	S432640
		208-277 220-240	MD	S29434	S31541	S432641
		380-415	MF	—	—	S432642
		440-480	MH	S29435	S31542	S432647
	DC	24-30	MO	S29436	S31543	S432643
		48-60	MV	S29437	S31544	S432644
		110-130	MR	S29438	S31545	S432645
		250	MS	S29439	S31546	S432646
		Communicating motor for electrically-operated circuit breakers ♦	AC	220-240	NC	S429441
Locking device	Mounting hardware		—	—	—	S32649
	Ronis lock		—	S41940	S41940	S41940
	Profalux lock		—	S42888	S42888	S42888
	Mounting hardware plus Ronis lock		—	S429449	S429449	—
Operations counter			—	—	—	S32648
Adapter for I-Line circuit breaker			—	S37420	S37420	—

Spring-Charging Motors for Electrically-Operated P-Frame Circuit Breakers

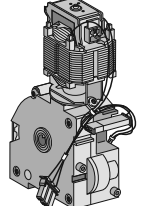
Description	Rated Voltage	Factory Installed	P-Frame (For Field-replacement Only)	Replacement Coils	
		Cat. No. Suffix	Spring Charging Motor Cat. No.	Opening/Closing Coil Cat. No.	
 <p>Standard motor for electrically-operated circuit breakers. Factory-installed includes motor and opening/closing coils.</p>	AC	48	ML	S47391	S33660
		100-130	MA	S47395	S33661
		220-240	MC	S47396	S33662
		380-415	MF	S47398	S33664
		24-30	MO	S47390	S33659
	DC	48-60	MV	S47391	S33660
		110-130	MR	S47392	S33661
		200-250	MS	S47393	S33662
		48	NL	S47391	S33034
		100-130	NA	S47395	S33035
<p>Communicating motor mechanism for electrically operated circuit breakers. Factory-installed includes motor and opening/closing coils.</p>	AC	220-240	NC	S47396	S33036
		380-415	NF	S47398	S33038
		24-30	NO	S47390	S33033
	DC	48-60	NV	S47391	S33034
		110-130	NR	S47392	S33035
		200-250	NS	S47393	S33036

Rotary Operated Handles

Device	Description	H- and J-Frame ▲		L-Frame		P-Frame	
		Factory Installed Cat. No. Suffix	Field Installable Cat. No.	Factory Installed Cat. No. Suffix	Field Installable Cat. No.	Factory Installed Cat. No. Suffix	
Direct Mounted	Standard black handle	Handle only	RD10	S29337	RD10	S32597	RD10
	Standard black handle with	Two early-break and two early make switches	—	—	—	—	RD16
		One early-break switch	RD12	S29337 + S29345	RD12	S32597 + S32605	—
	Red handle on yellow bezel	Two early-make switches	RD13	S29337 + S29346	RD13	S32597 + S29346	—
		Handle only	RD20	S29339	RD20	S32599	—
		One early-break switch	RD22	S29339 + S29345	RD22	S32599 + S32605	—
	Two early-make switches	RD23	S29339 + S29346	RD23	S32599 + S29346	—	
MCC conversion accessory	—	—	—	S32606	—		
CNOMO conversion accessory	—	—	—	S32602	—		
Door Mounted	Standard black handle	Handle only	RE10	S29338	RE10	S32598	RE10
	Standard black handle with:	Two early-break and two early make switches	—	—	—	—	RE16
		Two early make switches	RE13	S29338 + S29346	RE13	S32598 + S29346	—
	Red handle on yellow bezel	Handle only	RE20	S29340	RE20	S32600	—
Rotary Handle Replacement Kit	—	—	—	—	—	S33875	
Telescoping	—	—	—	—	—	—	
Accessories	Key lock adapter	—	S429344	—	S32604	—	
	Key locks	Ronis 1351.500	—	S41940	—	S41940	—
		Profalux KS5 B24 D4Z	—	S42888	—	S42888	—
		2 Ronis keylocks with 1 key	—	S41950	—	S41950	—
		2 Profalux keylocks with 1 key	—	S42878	—	S42878	—
	Indication Auxiliary Switch	One early-break switch	—	S29445	—	S32605	—
		Two early-make switches	—	S29346	—	S29346	—

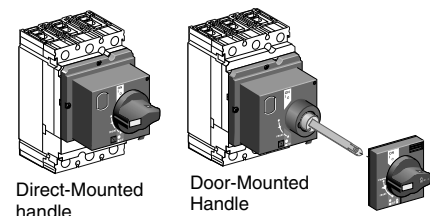

- ▲ Not available in H-frame 2P modules.
- Factory and field-installed standard motor operators for H- and J-frame circuit breakers require the SDE switch and SDE adapter (both included). Factory and field-installed standard motor operators for L-frame circuit breakers require the SDE switch (included).
- ♦ Installation requires BSCM with NSX Cord. See page DE3-49 for ordering information.

Locks, Interlocking

Device	Description	H- and J-Frame		Q-Frame		L-Frame		M- and P-Frame		R-Frame		
		Factory Installed Cat. No. Suffix	Field-Installed Cat. No.	Factory Installed Cat. No. Suffix	Field-Installed Cat. No.	Factory Installed Cat. No. Suffix	Field-Installed Cat. No.	Factory Installed Cat. No. Suffix	Field-Installed Cat. No.	Factory Installed Cat. No. Suffix	Field-Installed Cat. No.	
Handle Padlocking Device	Removable (lock OFF only)	—	S29370	—	—	—	S29370	—	S44936	—	S33996	
	Fixed (lock OFF or ON)	YP	S29371	YP	QBPA	YP	S32631	YP	S32631	YP	S32631	
	Fixed (lock OFF only)-2P	YQ	H2PHLA	—	—	—	—	—	—	—	—	
	Fixed (lock OFF only)▲	YQ	S37422	YQ	QBPAF	YQ	NJPAF	YQ	MPRPAF	YQ	MPRPAF	
Interlocking (Not UL listed)	Mechanical for circuit breakers with rotary handles▲	—	S29369	—	—	—	S32621	—	S33890	—	—	
	Mechanical for circuit breakers with toggles▲	—	S29354	—	QBMIK	—	S32614	—	—	—	—	
Key Locking	Provision only, vertical mount, 1 or 2 locks	Kirk	—	—	—	—	—	JA	—	—	—	
	Provisions only, vertical mounting one key interlock including padlock provision, open position only.	Kirk	—	—	—	—	—	JE▲◆	—	JE◆	—	
	Provision only, horizontal mount 1 lock, M- and P-frame 1 or 2 locks, R-frame	Kirk	—	—	—	—	—	—	JK	—	JK	—
		Ronis	—	—	—	—	—	—	JB★	—	JB	—
	Provision and 1 lock, vertical mount	Profalux	—	—	—	—	—	—	JD★	—	JD	—
		Kirk	—	—	—	—	—	—	JG	—	—	—
	Provision and 1 lock, horizontal mount	Kirk	—	—	—	—	—	—	JL	—	JL	—
		Ronis	—	—	—	—	—	—	JC★	—	JC	—
		Profalux	—	—	—	—	—	—	JF★	—	JF	—
	Provision and 2 locks keyed alike	Kirk	—	—	—	—	—	JN	—	JN	—	
Provision and 2 locks keyed differently	Kirk	—	—	—	—	—	JP	—	JP	—		

- ▲ Not available in M frame or HD and HG 2P modules.
- ◆ Not available for M, P or P frame drawout. Only available on P frame electronic.
- ◆ Not available on I-Line

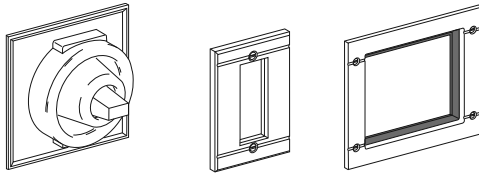

Handle Rubber Boot Door Escutcheon

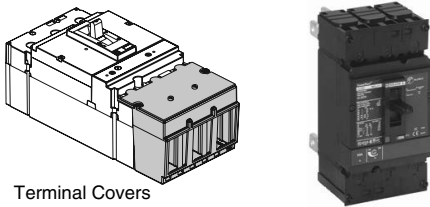

Terminal Covers Rear Connection

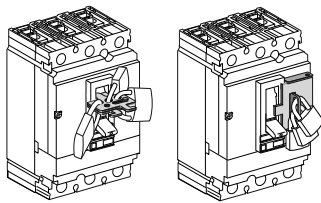

Removable Padlock Attachment Fixed Padlock Attachment

Rear Connections

Device	Description	H-Frame			J-Frame			L-Frame		
		Poles	Factory-Installed Termination No.	Field-Installable Cat. No.	Poles	Factory-Installed Termination No.	Field-Installed Cat. No.	Poles	Factory-Installed Termination No.	Field-Installed Cat. No.
Mixed Rear Connection Kit▼		2	S	—	2	S	—	3	S	S32477
		3	S	S37432	3	S	S37437	4	S	S32478
Consisting of:	Short rear connections (set of 2)	2 or 3	—	2x S37433	2 or 3	—	2x S37438	3	—	2x S432475
	Long rear connections (set of 2)		—	S37434		—	S37439Δ		—	2x S432476
	Short terminal cover (3P)	3	—	S37436	3	—	S37440	3	—	2x S32562
	Short terminal cover (4P)	4	—	—	—	—	—	4	—	2x S32563

- ▼ Kit contains 4 short rear connections, 2 long rear connections (4 long rear connections for 4P), hardware, and 2 terminal covers..
- Δ For use with 3P circuit breakers only.

Installation Accessories for H-, J-, and L-Frame Circuit Breakers

Description	H- and J-Frame	L-Frame
	Field-Installed Cat. No.	Field-Installed Cat. No.
Front Panel Escutcheon for Toggle Breakers	S29315	32556
Front Panel Escutcheon for Rotary Handle, Motor Operator, or extended escutcheon	S29317	S32558
Phase Barriers (set of 6)	S29329	32570
Handle Rubber Boot★	S29319	S32560
Sealing Accessories (for front cover screws)	S29375	S29375
DIN rail mounting kit (requires 15 mm depth on a 35 mm DIN rail)★	S29305	—
DIN rail adapter	—	—
Handle Extensions (set of 5)	S29313	S432553

- ★ Not available in HD and HG 2P modules.

Installation Accessories for M-, P-, and R-Frame Circuit Breakers

Description	Frame	Field-Installed Cat. No.
	Door Escutcheon	Accessory Cover
Toggle Handle		M-, P-Frame S33717
Drawout		P-Frame S33857
Terminal Covers	P-Frame	Short lug cover 3P S33932
		Short lug cover 4P S33933
		Long lug cover 3P S33934
		Long lug cover 4P S33935
Replacement Handle	Standard	R-Frame S33997
	Standard Short	M-, P-Frame S46998
	Long	M-, P-Frame S46996

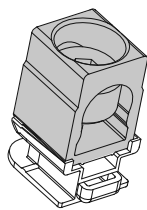

J-Frame Lug

Mechanical Lug Kits for H-Frame and J-Frame Circuit Breakers▲

Description	Circuit Breaker Application			Ampere Rating	Number of Wires Per Lug and Wire Range	Kit Cat. No.	Qty Per Kit
	Standard	Ampere Rating	Optional				
Al Lugs for Use with Al or Cu Wire	HD, HG, HJ, HL	15–150 A		150–175 A	(1) 14–3/0 AWG Al or Cu	AL150HD	3
	JD, JG, JJ, JL	150–175 A			(1) 4–4/0 AWG Al or Cu	AL175JD	3
	JD, JG, JJ, JL	200–250 A	JD,JG,JJ,JL		(1) 3/0–350 kcmil Al or Cu	AL250JD	3
Cu Lugs for Use with Cu Wire Only			HD,HG,HJ,HL	15–150 A	(1) 14–2/0 AWG Cu	CU150HD	3
			JD,JG,JJ,JL	150–250 A	(1) 1/0–300 kcmil Cu	CU250JD	3
Control Wire Terminal for H-frame lug kit						S37423	2
Control Wire Terminal for J-frame lug kit						S37424	2

▲ See page DE3-44 for terminal nuts/bus bar connections.

New!

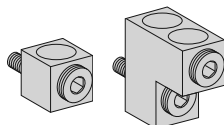

L-Frame Lugs

Mechanical Lug Kits for L-Frame Circuit Breakers

Description	Circuit Breaker Application				Number of Wires Per Lug and Wire Range	Kit Cat. No.	Qty Per Kit
	Ampere Rating	Poles	Unit Mount	I-Line			
Al Lugs for Use with Al or Cu Wire	250	3	X	X	(1) 2 AWG–500 kcmil Al (1) 2 AWG–600 kcmil Cu	AL400L61K3	3
		4	X	—		AL400L61K4	4
	400/600	3	X	—	(2) 2/0 AWG–500 kcmil Al or Cu	AL600LS52K3	3
		4	X	—		AL600LS52K4	4
Cu Lugs for Use with Cu Wire Only	400/600	3	X	X	(2) 3/0 AWG–500 kcmil Al or Cu	AL600LF52K3	3
		4	X	—		CU400L61K3	3
	250/400	3	X	X	(1) 2 AWG–600 kcmil Cu	CU400L61K4	4
		4	X	—		CU600LS52K3	3
	400/600	3	X	—	(2) 2/0 AWG–500 kcmil Cu	CU600LS52K4	4
		4	X	—		CU600LF52K3	3
400/600	3	X	X	(2) 3/0 AWG–500 kcmil Cu	CU600LF52K3	3	

DE3 CIRCUIT BREAKERS

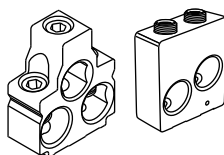

M- and P-Frame Lugs (800 A and below)

Mechanical Lug Kits for M-Frame, P-Frame and R-Frame Circuit Breakers▼

Description	Circuit Breaker Application				Wires per Lug and Wire Range	Cat. No.	Lugs Per Kit	
	Standard	Rating	Optional	Ampere Rating				
Al Lugs for AL or Cu Wire	M-, P-Frame	800 A	—	800 A	(3) 3/0 AWG-500 kcmil	AL800M23K	3	
		1200 A	PG, PJ, PL, MG, MJ	800 A	(4) 3/0 AWG-500 kcmil	AL1200P24K■	1	
		—	PG, PJ, PL, MG, MJ	800 A	(2) 3/0 AWG-600 kcmil	AL800P6K■	3	
		—	PG, PJ, PL, MG, MJ	800 A	(2) 3/0 AWG-600 kcmil	AL800P6K4■	4	
		—	PG, PJ, PL, MG, MJ	800 A	(2) 3/0 AWG-750 kcmil 750 kcmil: compact AL only	AL800P7K■	3	
		—	PG, PJ, PL, MG, MJ	800 A	(2) 3/0 AWG-750 kcmil 750 kcmil: compact AL only	AL800P7K4■	4	
	P-Frame	1200 A	PG, PJ, PL	800 A	(4) 3/0 AWG-500 kcmil	AL1200P25K◆	3	
		—	PG, PJ, PL	800–1200 A	(3) 350-600 kcmil	AL1200P25K4◆	4	
		PG,PJ,PL	—	PG, PJ, PL	1200 A	(3) 3/0 AWG-750 kcmil 750 kcmil: compact AL only	AL1200P6KU◆	3
		—	PG, PJ, PL	1200 A	(3) 3/0 AWG-750 kcmil 750 kcmil: compact AL only	AL1200P7KU◆	4	
		1200 A	I-Line	—	(4) 3/0 AWG-600 kcmil	AL1200R53K	1	
		2500 A	Unit Mount	—	(1) 3/0 AWG-750 kcmil	AL2500RK★	2	
Cu Lugs for Cu Wire Only□	M-, P-Frame	—	PJ	100–150 A	(1) 1-1/0 AWG	CU250P1K△	3	
		800 A	MG, MJ, PG, PJ, PL	—	(3) 3/0 AWG-500 kcmil	CU800M23K	3	
	1200 A	MG, MJ, PG, PJ, PL	800–1200 A	(4) 3/0 AWG-500 kcmil	CU1200P24K■	4		
	P-Frame	1200 A	PG, PJ, PL	800–1200 A	(4) 3/0 AWG-500 kcmil	CU1200P25K◆	3	
		1200 A	PG, PJ, PL	800–1200 A	(4) 3/0 AWG-500 kcmil	CU1200P25K4	4	
	R-Frame	1200 A	I-Line	—	(4) 3/0 AWG-500 kcmil	CU1200R53K	1	

■ Does not fit onto ON end of unit-mount P-frame circuit breakers.

◆ For unit-mount circuit breaker only.

★ All unit-mount R-frame circuit breakers require terminal pads for mounting lugs of any type. See page DE3-44.

▼ For lug with a tapped hole for control wire, add a "T" before the "K" in the catalog number (for example, AL800P6TK).

△ This lug can only be used on low amp PJ frame breakers where the Instantaneous setting must not be turned OFF. The cables must be laced with rope per lug instructions.

□ Not available with tapped hole for control wire.

PowerPact™ Circuit Breaker Accessories

Compression Lugs and Power Distribution Connectors (PDC)

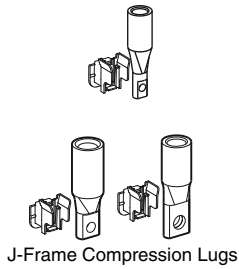

Compression Lug Kits for PowerPact™ Circuit Breakers

Description	Circuit Breaker Type	Ampere Rating	System Range	Mounting Type	Dimension A (in)	Max. Lugs per Terminal	Cat. No.	Qty. Per Kit
Compression Lug Kits for H-Frame and J-Frame Circuit Breakers								
Aluminum Compression Lug Kits	H-frame	60 A	6-2 AWG Al or Cu	Unit	1.2	1	YA060HD	3
		150 A	1/0-4/0 AWG Al or Cu		2.5	1	YA150HD	3
	J-frame	150 A	1-3/0 AWG Al or Cu		1.2	1	YA150JD	3
		250 A	3/0-350 kcmil Al or Cu		2.5	1	YA250J35	3
Copper Compression Lug Kits	H-frame	60 A	6-1/0 AWG Cu	Unit	1.0	1	CYA060HD	3
		150 A	4-2/0 AWG Cu		1.2	1	CYA150HD	3
	J-frame	150 A	6-1/0 AWG Cu		0.7	1	CYA150JD	3
		250 A	2/0-300 kcmil Cu		1.1	1	CYA250J3	3
Compression Lug Kits for L-Frame Circuit Breakers								
Aluminum Compression Lug Kits	L-frame	400 A	4-300 kcmil Al/Cu	Unit	1.2	1	YA400L31K3	3
		600 A	4-300 kcmil Al/Cu		2.5	2	YA600L32K3	6
		400 A	2/0-500 kcmil Al/Cu		1	1	YA400L51K3	3
		600 A	2/0-500 kcmil Al/Cu		2	2	YA600L52K3	6
		400 A	500-750 kcmil Al		1	1	YA400L71K3	3
		500 kcmil Cu	1		1	YA400L71K3	3	
		400 A	4-300 kcmil Al/Cu		1	1	YA400L31K4	4
		600 A	4-300 kcmil Al/Cu		2	2	YA600L32K4	8
		400 A	2/0-500 kcmil Al/Cu		1	1	YA400L51K4	4
		600 A	2/0-500 kcmil Al/Cu		2	2	YA600L52K4	8
Copper Compression Lug Kits	L-frame	400 A	500-750 kcmil Al	Unit	2.5	1	YA400L71K4	4
		500 kcmil Cu	1		1	YA400L71K4	4	
		400 A	2/0-300 kcmil Cu		1.2	1	CYA400L31K3	3
		600 A	2/0-300 kcmil Cu		2.5	2	CYA600L32K3	6
		400 A	250-500 kcmil Cu		1	1	CYA400L51K3	3
		600 A	250-500 kcmil Cu		2	2	CYA600L52K3	6
		400 A	2/0-300 kcmil Cu		1	1	CYA400L31K4	4
		600 A	2/0-300 kcmil Cu		2	2	CYA600L32K4	8
		400 A	250-500 kcmil Cu		1	1	CYA400L51K4	4
		600 A	250-500 kcmil Cu		2	2	CYA600L52K4	8
Compression Lug Kits for M-Frame, P-Frame, and R-Frame Circuit Breakers								
Aluminum Compression Lug Kits	M-, P-frame ♦	250 A	2/0-300 kcmil	Unit	3.7	2	YA250P3	1
		300 A	4/0-500 kcmil		3.9	2	YA300P5	1
		400 A	2/0-300 kcmil		4.3	2	YA400P3	2
		400 A	500-750 kcmil		3.7	2	YA400P7	1
		600 A	4/0-500 kcmil		3.9	2	YA600P5	2
		800 A	500-750 kcmil		4.3	2	YA800P7	2
	R-frame ▲♦	1200 A	2/0-300 kcmil	I-line	3.8	4	YA1200R3	4
		1200 A	4/0-500 kcmil		4.0	4	YA1200R5	4
		1200 A	500-750 kcmil		4.4	4	YA1200R7	4
		2000 A	2/0-300 kcmil		▲	8	YA2000R3	2
Copper Compression Lug Kits	M-, P-frame ♦	400 A	4/0-500 kcmil	Unit	3.3	2	CYA400P5	1
		600 A	4/0-500 kcmil		3.3	2	CYA600P5	2
		800 A	500-750 kcmil		3.6	2	CYA800P7	2
		1200 A	4/0-500 kcmil		3.5	4	CYA1200R5	4
R-frame ♦	1200 A	500-750 kcmil	I-Line	3.8	4	CYA1200R7	4	

New!

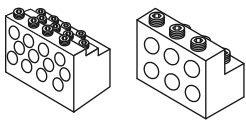
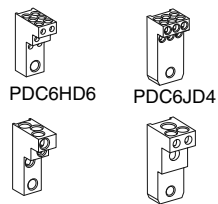
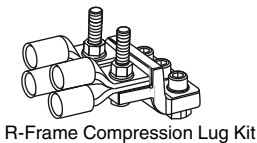
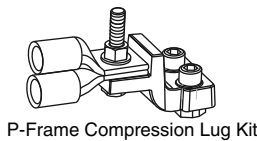

Crimp lug or PDC connectors extension past end of circuit breaker "A" See Table

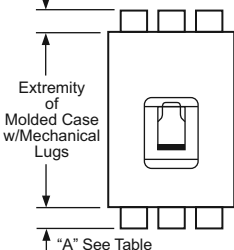

- ▲ All unit-mount R-frame circuit breakers require terminal pads for mounting lugs of any type. See page DE3-44.
- ♦ 9 lugs for 3000 A circuit breakers
- ◆ Not for use on I-Line™ circuit breakers unless wire bending space is adequate.

Power Distribution Connectors for H-Frame, J-Frame and L-Frame Circuit Breakers

Use with Circuit Breaker Type	Circuit Breaker Ampere Rating	Wires Per Terminal & Wire Range	Dimension A (in.)	Cat. No.	Qty. Per Kit
HD, HG, HJ, HL★	15-150	(6) 14-6 AWG Cu	1.0	PDC6HD6	3
	15-150	(3) 14-2 AWG Cu	1.2	PDC3HD2	3
JD, JG, JJ, JL★	150-250	(6) 14-4 AWG Cu	1.0	PDC6JD4	3
	150-250	(2) 14-1 AWG and (1) 3-2/0 AWG Cu	1.5	PDC3JD20	3
LD, LG, LJ, LL	150-600	(3) 14-1 AWG and (2) 3-2/0 AWG	1.28Δ	PDC5DG20L3	3
	150-600	(12) 14-4 AWG	1.31Δ	PDC12DG4L3	3

★ OFF end only when OFF end is the load end.

Power Distribution Connectors for M-Frame and P-Frame Circuit Breakers

Use for multiple load connections on one circuit breaker in place of standard distribution block to save space and time.	Ampere Rating	(Wires Per Terminal) Wire Range	Cat. No.	Qty Per Kit
• Use on load end of circuit breaker only. • Use in UL508 Industrial Control applications only. • Use in UL1995/CSA C22.2 No. 236 heating and cooling equipment. • For Cu wire only.	250-1200 A	(6) 12-2/0 AWG Cu	PDC6P20	3
		(6) 12-2/0 AWG Cu	PDC6P204	4
• Not for use with I-Line™ circuit breakers. • Kit includes long terminal shield and cover, which adds 1.65 inches to standard lug with short terminal shield.	250-1200 A	(12) 10-4 AWG Cu	PDC12P4	3
			PDC12P44	4

- ▼ Not for use with I-Line™ circuit breakers.
- Δ Kit includes long terminal shield and cover, which adds 1.65 inches to standard lug with short terminal shield.

DE3 CIRCUIT BREAKERS

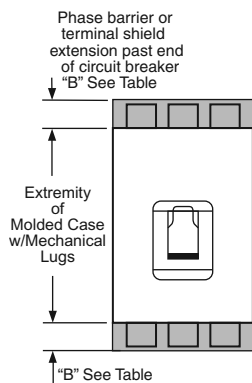
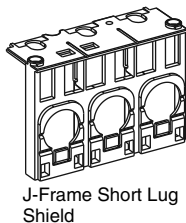
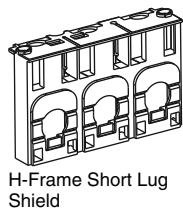
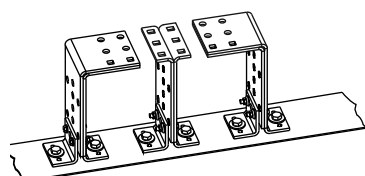
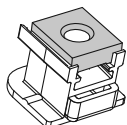
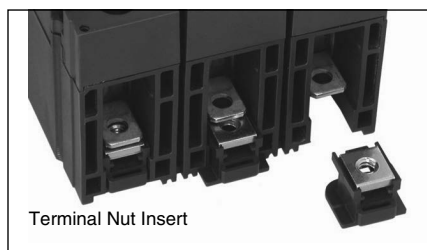

Terminal Nuts for Bus Bar Connection of H-Frame and J-Frame Circuit Breakers

Description	Frame	Tap	Cat. No.	Qty Per Kit
H-Frame Terminal Nut Insert-English	HD/HG/HJ/HL	1/4-20	S37425	2
H-Frame Terminal Nut Insert-English	HD/HG/HJ/HL	1/4-20	S37444	3
H-Frame Terminal Nut Insert-Metric	HD/HG/HJ/HL	M6	S37426	2
J-Frame Terminal Nut Insert-English	JD/JG/JJ/JL	1/4-20	S37427	2
J-Frame Terminal Nut Insert-English	JD/JG/JJ/JL	1/4-20	S37445	3
J-Frame Terminal Nut Insert-Metric	JD/JG/JJ/JL	M8	S37428	2
Control Wire Terminal for H-Frame Terminal Nut	HD/HG/HJ/HL		S37429	2
Control Wire Terminal for J-Frame Terminal Nut	JD/JG/JJ/JL		S37430	2

Bus Bar Connections Hardware for L-Frame, M-Frame and P-Frame Circuit Breakers

Frame	Description	Term. No.	Poles	Cat. No.
L-Frame	Set of 4 terminal screws and washers for one side	F	4	S36967
M- and P-Frame	Bus Connector Kit for one pole, one end		1	S33928

Terminal Pad Kits for R-Frame Circuit Breakers

R-Frame Circuit Breaker	Terminal Pad Kit		Field-Installable Kits	
	Usage	Lugs per Phase	3P Kit (One End Only)	4P Kit (One End Only)
			Cat. No.	Cat. No.
3000 A, 100% Rated	Required for cable or bus	9	RL3TB	RL3TB4
3000 A, Standard (80% Rated)	Required for cable or bus	8	RLTB	RLTB4
2500 A, 100% Rated	Required for cable or bus			
2500 A, Standard (80% Rated)	Required for cable, optional for bus			
All Other R-Frame Circuit Breakers	Required for cable, optional for bus			

For cable connection to RLTB, use AL2500RK lug. See page DE3-43.

Terminal Shields and Phase Barriers

Used With	Description			Dimension B (in.)	Cat. No.	Qty Per Kit					
H- and J-Frame Mechanical Lugs	Short Lug Shield▲	Frame	Max. Wire Size	0.50	S37446	1					
		H-Frame 60 A	3 AWG								
		H-Frame 150 A	3/0 AWG				0.50	S37447	1		
		J-Frame	350 kcmil				0.24	S37448	1		
H- and J-Frame Power Distribution Connectors and Compression Lugs	Compatible with:	PDC	Compression Lugs		2.24	S37449	1				
			Aluminum	Copper							
		H-Frame Long Lug Shield	PDC6HD6	YA060HD				CYA060HD	1.68	S37450	1
			PDC3HD2	YA150HD				CYA150HD			
		J-Frame Long Lug Shield	PDC6JD4	YA150JD				CYA150JD	1.68	S37450	1
			PDC3JD2	■				CYA250J3			
M-, P-Frame	Phase Barriers				S33646	3					
R-Frame	Phase Barriers				S33998						

- ▲ Short lug shields provide IP20 protection for mechanical lugs and are compatible with control wire terminals.
- J-frame terminal shield is not compatible with the YA250J35 compression terminal.

Miscellaneous H-, J-, and L-Frame Circuit Breaker Accessories

Accessory	Description	Field-Installed Cat. No.
Spare Parts	Bag of screws for accessory cover, L-frame	S432552
	1 spare toggle extension, L-frame	32595
	Set of 10 identification labels	LV429226

PowerPact™ Circuit Breaker Accessories

Class 611, 612 / Refer to Catalogs 0611CT1001, 0612CT0101

Plug-In and Drawout Mountings



H-Frame and J-Frame Plug-in Mounting



H-Frame and J-Frame Drawout Mounting

Plug-In and Drawout Mountings for H- and J-Frame Circuit Breakers (3P or 2P in a 3P module)

Description		Factory Installed Cat. No.	Field-Installed Cat. No.	
Complete Factory-Assembled Circuit Breakers	Plug-in base shipped with circuit breaker	N		
	Drawout cradle shipped with circuit breaker	D		
Special Order Options for Plug-In and Drawout Circuit Breakers	Plug-In Base	Circuit breaker Only Plug-in base kit	HJ00 S29278	
	Drawout Cradle	Circuit breaker only Plug-in base kit	HJ00 S29278	
		Cradle side plates (fixed part of chassis) Circuit breaker side plates (moving part of chassis)	S29282 S29283	
Accessories for Plug-In and Drawout	H-Frame Shutter Kit (set of two)		S37442	
	J-Frame Shutter Kit (set of two)		S37443	
	Secondary Disconnect Blocks	Fixed part 9-wire connector (mounted on base)		S29273
		Moving part 9-wire connector (mounted on circuit breaker)		S29274
		Support for 2-moving connectors		S29275
	Extended escutcheon with extended toggle handle		S29284	
Two position indicating switches (connected/disconnected)		S29287		
H-Frame Short Terminal Cover (3P)		S37436		
J-Frame Short Terminal Cover (3P)		S37440		



L-Frame Plug-In Mounting

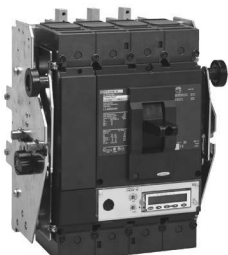

L-Frame Drawout Mounting

New!

Plug-In and Drawout Mountings for L-Frame Circuit Breakers

Description	Poles	Plug-in Mounting		Drawout Mounting		
		Factory Installed Cat. No.	Field-Installed Cat. No.	Factory Installed Cat. No.	Field-Installed Cat. No.	
Kit (stationary and moving parts)	3	N		D		
	4	N		D		
Stationary Part	Plug-in base		S32514		S32514	
	Fixed part of chassis		S32515		S32515	
Moving Part	Circuit breaker only		HJ00	HJ00		
	Moving part of chassis				S32533	
	Short terminal covers	3	2x	S32562	2x	S32562
		4	2x	S32563	2x	S32563

▲ Price shown is for quantity of 1.

Plug-In and Drawout Accessories for L-Frame Circuit Breakers

Description	Field-Installed Cat. No.		
Secondary Disconnecting Blocks	Fixed Part	9-wire connector	S29273
	Moving Part	9-wire connector	S32523
		Support for 3 moving connectors	S32525
	Fixed + Moving	9-wire manual auxiliary connector	S29272
Shutters	Two shutters for plug-in base	32521	
Chassis Accessories	Extended escutcheon for toggle	S32534	
	Locking device (key lock is not included)	S29286	
	Two position indicating switches (connected/disconnected)	29287	

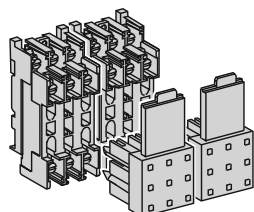

L-Frame Disconnecting Blocks

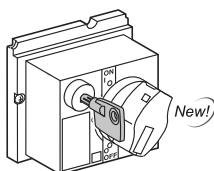

L-Frame Locking Device

New!

Termination Options

Termination Letter For factory-installed termination, place termination letter in the third block of the circuit breaker catalog number.

N = Plug-in
D = Drawout

L G L 3 6 4 0 0 U 3 1 X

L Termination No.

Drawout Cradle and Accessories for P-Frame Circuit Breakers

Description	Cat. No.
Drawout Cradle	Product Selector
Cradle	Front Connected Flat (FCF)
Connectors	SFCF12■
	Rear Connected T Horizontal/Vertical (RCTH/RCTV)
	SRCTV12■
	Modbus™ cradle communication module
	S33852
	Safety shutters
	S48933
	Secondary disconnects terminal shield
	S33763
	Cradle position switch 1a/1b Form C— Connected/test/disconnected
	S33170
	Low level cradle position switch 1a/1b Form C—Connected/test/disconnected
	S33171
	Cell keying kit
	S33767
	Disconnected position key locking—provision for Kirk or Federal Pioneer Lock
	S33772
	Door interlock kit
	S33786
	Racking interior kit
	S33788
	Door escutcheon (for replacement only, included with circuit breaker)
	S33857
	Transparent cover
	S33859
	Push-in terminal kit (3 wires)
	S33098
	Push-in terminal kit (6 wires)
	S33099
	Finger cluster
	S33166
	Cluster grease (12 oz. tube)
	S48899

■ Needs 2 kits per cradle.

DE3 CIRCUIT BREAKERS

DE3

New!

PowerPact™ H-, J-, and L-Frame Micrologic™ Trip Units

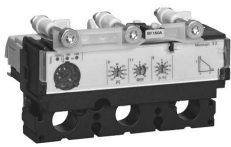

Micrologic Standard Trip Unit



Micrologic Ammeter and Energy Trip Unit

PowerPact™ H-, J-, and L-frame molded case circuit breakers may be specified with any of the following Micrologic Electronic Trip Units.

Micrologic Standard 3.2/3.3 Trip Units

- True RMS sensing
- LI, LSI trip configurations
- Field-interchangeable trip units
- LED long-time pickup and trip indication
- Test kits available
- Thermal imaging

Micrologic Ammeter 5.2A/5.3A/6.2A/6.3A Trip Units

Includes all features listed for Micrologic standard trip unit, as well as:

- Advanced user interface
- Neutral protection
- Incremental fine tuning of settings
- Up to 12 alarms
- Digital ammeter—phase and neutral (4-pole only)
- Phase loading bar graph
- Maintenance indicators including contact wear, number of operations, operating hours, and load profiles
- Cause of trip information for troubleshooting assistance
- LCD Display
- Zone-selective interlocking (ZSI) (short-time & ground-fault)
- Optional Modbus™ communications—PowerLogic™ compatible

Micrologic Energy 5.2E/5.3E/6.2E/6.3E Trip Units

Includes all features listed for Micrologic ammeter trip unit, as well as:

- Ground-fault trip with programmable ground fault alarm (available on 6.2E/6.3E only)
- Power and energy measurement
- Power quality measurements
- Current demand and power demand measurements

Micrologic Trip Units^Δ for PowerPact H-, J-, and L-Frame Circuit Breakers

x – Standard Feature o – Available Option

Features	Standard		Ammeter		Energy	
	3.2/3/3	3.2S/3.3S	5.2A/5.3A	6.2A/6.3A	5.2E/5.3E	6.2E/6.3E
LI	x					
LSI [▲]		x	x		x	
LSIG / Ground-Fault Trip [■]				x		x
Ground-Fault Alarm/Trip [■]				x		x
Current Setting Directly in Amperes	x	x	x	x	x	x
True RMS Sensing	x	x	x	x	x	x
UL Listed	x	x	x	x	x	x
Thermal Imaging	x	x	x	x	x	x
LED for Long-time Pickup	x	x	x	x	x	x
LED for Green "Ready"	x	x	x	x	x	x
Up to 12 Alarms Used Together			x	x	x	x
Digital Ammeter			x	x	x	x
Zone-selective Interlocking [◆]			x	x	x	x
Communications	o	o	o	o	o	o
LCD Display			x	x	x	x
Front Display Module FDM121			o	o	o	o
Advanced User Interface			x	x	x	x
Neutral Protection [■]			x	x	x	x
Contact Wear Indication [★]			x	x	x	x
Incremental Fine Tuning of Settings			x	x	x	x
Load Profile ^{★,▼}			x	x	x	x
Power Measurement					x	x
Power Quality Measurements					x	x

- ▲ The LSI with 3.2S/3.3S trip units have fixed short time and long time delays.
- Requires neutral current transformer on the three-phase four-wire loads
- ◆ ZSI for H/J frames is only OUT. for L-frame ZSI is In and OUT.
- ★ Indication available using the communication system only.
- ▼ % of hours in 4 current ranges: 0–49%, 50–79%, 80–89%, and >90% In.
- Δ DC not available with electronic trip units.

Micrologic Trip Unit Settings for H- and J-Frame

Model	Trip Function	Trip Unit	Ampere Setting
Standard	LI	3.2	15-20-25-30-35-40-45-50-60 35-40-45-50-60-70-80-90-100 50-60-70-80-90-100-110-125-150 70-80-100-125-150-175-200-225-250
			LSI
Ammeter	LSI	5.2A	
			LSIG
Energy	LSI	5.2E	
			LSIG

Micrologic Trip Unit Settings for L-Frame

Model	Trip Function	Trip Unit	Ampere Setting
Standard	LI	3.3	70-80-100-125-150-175-200-225-250 125-150-175-200-225-250-300-350-400 200-225-250-300-350-400-450-500-600
			LSI
Ammeter	LSI	5.3A	
			LSIG
Energy	LSI	5.3E	
			LSIG

Powerpact P- and R-Frame, and Masterpact Micrologic Electronic Trip Units

Each adjustment times the sensor rating (I_n X In) or the circuit breaker sets the long-time pickup value of the circuit breaker.



Powerpact® circuit breakers may be specified with any of the following Micrologic Electronic Trip Units.

Micrologic (Standard) 3.0 and 5.0 Trip Units

- True RMS sensing
- LI, LSI trip configurations
- Field-interchangeable long-time rating plugs
- LED long-time pickup indication
- Test kits available
- Thermal imaging

Micrologic (Ammeter) 3.0A, 5.0A and 6.0A Trip Units

Includes all features listed for Micrologic standard trip unit, as well as:

- LSI trip configurations
- Digital ammeter—phase and neutral
- Phase loading bar graph
- LED trip indication
- Zone-selective interlocking (ZSI) (short-time & ground-fault)
- Optional Modbus™ communications—PowerLogic® compatible

Micrologic (Power) 5.0P and 6.0P Trip Units

Power measurement and advanced protection features includes all features listed for Micrologic ammeter trip unit, as well as:

- LSI trip configuration with programmable ground fault alarm
- LSI (Ground-fault trip) with programmable ground fault alarm
- Incremental “fine tuning” of L, S, I, and G pickup and delay settings
- LCD dot matrix display and LED trip indication
- Advanced user interface
- Advanced protection IDMTL—selectable long-time delay bands
- Neutral protection
- Power measurement
- Contact wear indication
- Modbus communications—PowerLogic compatible
- Local and remote settings

Micrologic (Harmonic) 5.0H and 6.0H Trip Units

Power quality measurement and advanced protection features. Includes all features listed for the Micrologic power trip unit, as well as:

- Enhanced power measurements functions
- Power quality measurements

Adjustable Rating Plugs—Selection

To provide maximum design flexibility, system protection, and field upgradeability, each Micrologic® trip unit is equipped with an interchangeable long-time rating plug. Each trip unit requires an adjustable rating plug to determine the long-time pickup range of the circuit breaker. These plugs are factory-installed on new trip units, or can be ordered separately for field-installable upgrades.

Adjustable rating plugs are offered in eight different ranges of long-time pickup adjustments. The following chart show the ranges of adjustments.

Long-time Pickup Settings

Rating Plug	Long-time Pickup Settings								
A	1.0	.90	.80	.70	.63	.60	.50	.45	.40
B	1.0	.95	.88	.75	.63	.56	.50	.44	.40
C	1.0	.95	.83	.75	.67	.56	.53	.50	.42
D	1.0	.95	.93	.90	.80	.70	.64	.48	.40
E	1.0	.95	.93	.90	.85	.80	.75	.70	.60
F	1.0	.98	.96	.94	.92	.90	.88	.86	.84
G	.82	.80	.78	.76	.74	.72	.70	.68	.66
H	.64	.62	.60	.58	.56	.54	.52	.50	.48

Micrologic Trip Units ✓ – Standard Feature ○ – Available Option

Features	Standard		Ammeter			Power		Harmonic	
	3.0	5.0	3.0A	5.0A	6.0A	5.0P	6.0P	5.0H	6.0H
LI	✓		✓						
LSI (Instantaneous can be turned off)		✓		✓		✓			✓
LSIG / Ground-Fault Trip					✓	✓			✓
Ground-Fault Alarm (No Trip) ▲■						✓		✓	
Ground-Fault Alarm and Trip ▲■							✓		✓
Adjustable Rating Plugs	✓	✓	✓	✓	✓	✓	✓	✓	✓
True RMS Sensing	✓	✓	✓	✓	✓	✓	✓	✓	✓
UL Listed	✓	✓	✓	✓	✓	✓	✓	✓	✓
Thermal Imaging	✓	✓	✓	✓	✓	✓	✓	✓	✓
Phase Loading Bar Graph			✓	✓	✓	✓	✓	✓	✓
LED for Long-time Pickup	✓	✓	✓	✓	✓	✓	✓	✓	✓
LED for Trip Indication			✓	✓	✓	✓	✓	✓	✓
Digital Ammeter			✓	✓	✓	✓	✓	✓	✓
Zone-selective Interlocking			✓	✓	✓	✓	✓	✓	✓
Communications			○	○	○	✓	✓	✓	✓
LCD Dot Matrix Display						✓	✓	✓	✓
Advanced User Interface						✓	✓	✓	✓
Protective Relay Functions						✓	✓	✓	✓
Neutral Protection ▲						✓	✓	✓	✓
Contact Wear Indication						✓	✓	✓	✓
Incremental Fine Tuning of Settings						✓	✓	✓	✓
Selectable Long-time Delay Bands						✓	✓	✓	✓
Power Measurement						✓	✓	✓	✓
Power Quality Measurements								✓	✓
Waveform Capture								✓	✓

- ▲ Requires neutral current transformer in 3Ø4W systems.
- Requires M2C or M6C Programmable Contact Module.

Micrologic Trip Unit and Options

Model	Protection	Additional Features	Field-Installable Cat. No.♦	Kit \$ Price / Circuit Breaker \$ Price Adder
2.0 (IEC only)	LSO		S132R	
3.0 (UL/ANSI only)	LI	None	S131A	
5.0	LSI		S133A	
2.0A (IEC only)	LSO		S142R★	
3.0A (UL/ANSI only)	LI	Ammeter	S141A★	
5.0A	LSI		S143A★	
6.0A	LSIG		S144A★	
5.0P	LSI	Metering, Adv. Protection	S163A★▼	
6.0P	LSIG	Metering, Adv. Protection	S164A★▼	
5.0H	LSI	Metering, Adv. Protection & Harmonic Analysis	S173A★▼	
6.0H	LSIG	Metering, Adv. Protection & Harmonic Analysis	S174A★▼	

- ♦ The standard rating plug supplied with a trip unit will be the “A” rating plug. To specify an alternative adjustable rating plug, please add the letter designation to the end of the catalog number. Please refer to page DE3-48 for a complete listing of adjustable settings available with each plug. (Example: S143B would specify a “B” rating plug instead of the standard “A” plug.) Use suffix “N” if no rating plug is required.
- ★ When replacing a standard trip unit with Type A (Ammeter), P (Power metering) or H (Harmonic analysis) trip unit, order the 12-pin connector kit S33101 for the Masterpact NW and NT and the PowerPact P-frame drawout circuit breakers or kit S33100 for PowerPact P-frame and R-frame unit-mount and I-Line circuit breakers. See page DE3-48.
- ▼ Requires Circuit Breaker Communications Module.

Special Options

Description	Factory-Installed Suffix	Field-Installable Cat. No.
Ship circuit breaker in closed position	YK	N/A
CT Characterization (Calibrated trip system)	Q	N/A

DE3 CIRCUIT BREAKERS

Micrologic™ Electronic Trip Unit

Micrologic™ Trip Unit Accessories

Class 612 / Refer to Catalog 0612CT0101



Full Function Test Kit

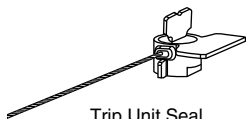

Trip Unit Seal



Sensor Plug

Adjustable rating plug "A" is installed as standard on all Micrologic trip unit orders. However, an alternative selection may be specified from the "Assembled" table below, and factory-installed with your trip unit order at no additional charge. To order, please attach the appropriate catalog suffix to the end of the trip unit catalog number (after specifying trip unit options). Adjustable rating plugs may also be purchased as field-installable components from the table below.

Rating Plugs

Rating Plug ▲	Factory-Installed	Field-Installable
	Cat. Suffix	Cat. No.
A	A (standard)	S48818
B	B	S48819
C	C	S48820
D	D	S48836
E	E	S48837
F	F	S48838
G	G	S48839
H	H	S48840

▲ Long-time pickup amperes (I_r) = Sensor Rating (In) X Setting of rating plug.

- "Fine adjustment tuning" is included on Micrologic Power and Harmonic trip units, allowing for incremental settings of 1 ampere between the plug setting and .40 X Sensor Rating.

Neutral Current Transformers

For Use with Circuit Breaker	Cat. No.	Sensor
H-Frame	S429521	60-100
	S430562	150
J-Frame	S430563	250
L-Frame	S432575	400-600
P-Frame	S33575 ■	250
	S33576 ■	400-1600
R-Frame	S48916 ■	250
	S34036 ■	400-1600
	S48896 ■	2000
	S48182 ■	3000
All	NCTWIRING	All

■ Includes NCTWIRING kit.

Trip Unit Accessories

Device	Frame	Cat. No.
Pocket Tester		S434206
UTA Tester		STRV00910
Spare UTA Tester		STRV00911
Bluetooth/Modbus for UTA Tester	H/J/L	SVW3A8114
Spare Power Supply for UTA Tester 110-120 Vac		TRV00915
Micrologic Cord for UTA Tester		TRV00917
Micrologic 5/6 Cover, Transparent	H/J	S429478
Micrologic 2/3 Cover, Transparent		S429481
Micrologic 5/6 Cover, Transparent	L	S432459
Micrologic 2/3 Cover, Transparent		S432461
LCD Display for Micrologic 5		S429483
LCD Display for Micrologic 6	H/J/L	S429484
Hand-held Test Kit		S33594
Primary Injection Test Adaptor		S33937
Full-function Adapter Kit		S48981
Full-function Test Kit	P/R	S33595
Seven-pin Test Cable (for connection between test kit and trip unit) ◆		S48907
Two-pin Test Cable (for connection between test kit and trip unit) ★		S48908
230 Vac Filtered Power Cord ▼		S48856
120 Vac Filtered Power Cord ▼	P/R	S48855
Trip Unit Battery for Trip Indicator Lights		S33593
Power supply with:		
24-30 Vdc input		685823
48/60 Vdc input		685824
125 Vdc input	H/J/L/P/R	685825
110-130 Vac input		685826
200-240 Vac input		685827
380-415 Vac input		685829
Micrologic A Trip Unit Cover, clear		S33592
Micrologic P/H Trip Unit Cover, opaque gray	P/R	S47067
Trip Unit Seal (6 pieces) for compliance with NEC 240.6(c)	H/J/L/P/R	MICROTUSEAL
12-pin Trip Unit Connector for NT/NW Masterpact Circuit Breakers		S33101
12-pin Trip Unit Connector for P- and R-Frame Circuit Breakers	P/R	S33100
Battery Back-up (12 Hours)		685831

◆ Used for testing Micrologic trip units. Included in the price of the Hand-held/Full-function Test Kits. Kit for replacement only.

★ Used for testing STR trip units. Included in the price of the Hand-held/Full-function Test Kits. Kit for replacement only.

▼ Included in the price of the Full-function Test Kit. Kit for replacement only.

Sensor Plugs for P- and R-Frame Circuit Breakers ▲ ◇

Circuit Breaker	Sensor Plug Range	Sensor Plug Catalog No.	Circuit Breaker Frames Accepting Sensor Plug											
			250 A	400 A	600 A	630 A □	800 A	1000 A	1200 A	1250 A □	1600 A			
P-Frame Circuit Breaker														
UL	250 A	S47052	X											
	400 A	S47053		X	X		X							
	600 A	S48823			X		X	X	X					
	800 A	S33092					X	X	X					
	1000 A	S33093							X	X				
	1200 A	S48824								X				
IEC	630 A	S33091				X	X	X			X	X		
	800 A	S33092					X	X			X	X		
	1000 A	S33093						X			X	X		
	1250 A	S33094									X	X		
	1600 A	S33095										X	X	
R-Frame Circuit Breaker			600 A	800 A	1000 A	1200 A	1600 A	2000 A	2500 A	3000 A	3200 A			
UL	600 A	S48823	X	X	X	X								
	800 A	S33092		X	X	X	X							
	1000 A	S33093			X	X	X	X						
	1200 A	S48824				X	X	X	X					
	1600 A	S33095					X	X	X	X	X			
	2000 A	S33982						X	X	X	X			
	2500 A	S33983							X	X	X			
IEC	3000 A	S48825									X			
	1600 A	S33095					X	X	X	X	X	X		
	2000 A	S33982						X	X	X	X	X		
	2500 A	S33983							X	X	X	X		
	3200 A	S33984								X	X	X	X	

▲ For use only with circuit breakers with date codes later than 07011.

□ IEC Only.

◇ See rating plug for long-time pickup range on page DE3-47.

Trip Unit Field-Installable Accessories for P- and R-Frame Circuit Breakers

Description	Factory-Installed Cat. No. Suffix	Field-Installable Kit Cat. No.						
		P-Frame					R-Frame	
		Unit Mount	I-Line	Motor Operated	Drawout	With Rotary Handle	Unit Mount	I-Line
Circuit Breaker Communication Module (BCM) (Modbus)	E1	S64205	S64205	S64207	S64206	S64205	S64205	S64205
Two Programmable Contacts Module (M2C)	V	S64273	S64273	S64273	S64273	S64273	S64273	S64273
Six Programmable Contacts Module (M6C)	W	S64204	S64204	S64204	S64202	S64204	S64201	S64201
External Voltage Sensing (EVS)	YV	S64203	S64203	S64210	S64209	S64210	S64208	S64208

New!

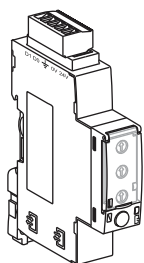

Modbus Interface Module (IFM)

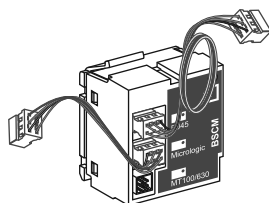

Breaker Status and Control Module (BSCM)

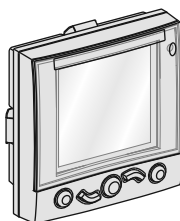

Front Display Module (FDM)

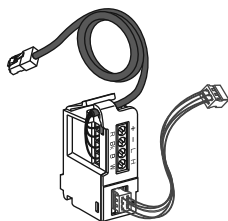

NSX Cord for Modbus Communications

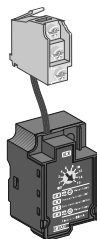

SDTAM Module (Remote indication relay for motor applications)

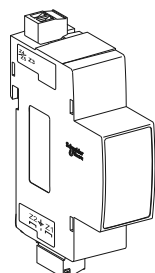

ZSI Interface Module (Connects PowerPact H/J/L circuit breakers to PowerPact P/R and Masterpact NT/NW circuit breakers)

Trip Unit Field-Installable Accessories for H-, J-, and L-Frame Circuit Breakers

Description	Factory-Installed	Field-Installable Kit
	Cat. No. Suffix	Cat. No.
External Accessories		
Modbus Interface Module IFM▲	—	STRV00210
Stacking Connections for IFM (10)	—	TRV00217
Front Display Module FDM121▲	—	STRV00121
FDM Mounting Accessory (Dia. 22 mm)	—	TRV00128
Isolated Modbus Repeater Module	—	STRV00211
ZSI Interface Module	—	S434212
Internal Accessories		
NSX Cord ■ (for Modbus Communication)	L = 1.3 m L = 3 m	EA EB
BSCM (Breaker Status and Control Module) with NSX Cord■	L = 1.3 m L = 3 m	EGΔ EHΔ
Replacement BSCM	—	S434205
NSX Cord for V > 480 Vac■	L = 1.3 m L = 3 m	ED EE
BSCM with NSX Cord for V > 480 Vac■	L = 1.3 m L = 3 m	EKΔ ELΔ
24 Vdc Terminal Block	—	EN
SDTAM 24/415 Vac/dc Module♦	—	V
SDX Module 24/415 Vac/dc★	—	V

- ▲ Require NSX Cord
- Installation requires IFM (STRV00210) for Modbus communication and/or FDM (STRV00121) for external display
- ♦ Remote indication relay for motor applications
- ★ Remote indication relay
- ▼ For proper selection, see catalog 0611CT1001.
- Δ If using with motor operator requires communicating motor operator (suffix NC).

Wire Harness□ and ULP Cords for H-, J-, and L-Frame Circuit Breakers

Description	Factory-Installed	Field-Installable Kit Cat. No.
	Cat. No. Suffix	Cat. No.
ZSI Wire Harness, H/J Frame	YH3	S434300
ZSI Wire Harness, L-Frame	YH3	S434301
ENCT Wire Harness	YH2	S434302
OF Wire Harness	YH1	S434500
SD/SDE Wire Harness	YH1	S434501
SDx/SDTAM Wire Harness	YH1	S434502
MN Wire Harness	YH1	S434503
MX Wire Harness	YH1	S434504
24 Vdc Terminal Block Wire Harness♦	YH1	S434505
Motor Operator Wire Harness	YH1	S434506
Communicating Motor Operator Wire Harness	YH1	S434507
NSX Wire Harness♦	YH1	S434508
ENCT and ZSI Wire Harness	YH4	—
10 RJ45 Connectors female/female	—	TRV00870
10 ULP Line Terminations	—	TRV00880
10 RJ45/RJ45 Male Cords	L = 0.3 m	TRV00803
	L = 0.6 m	TRV00806
	L = 1 m	TRV00810
5 RJ45/RJ45 Male Cords	L = 2 m	TRV00820
	L = 3 m	TRV00830
	L = 5 m	TRV00850

- Wire harness is required for I-Line applications, optional for unit-mount applications
 - YH1 = all installed accessories but ZSI and ENCT
 - YH2 = ENCT and all installed accessories
 - YH3 = ZSI and all installed accessories
 - YH4 = ZSI, ENCT and all installed accessories
- ♦ I-Line wire harness is included for communication network accessories. Optional wire harness for unit mount requires YH1 suffix.

Masterpact™ Universal Power Circuit Breakers

Masterpact™ NT/NW Circuit Breakers

Class 613 / Refer to Catalog 0613CT0001



Masterpact NT

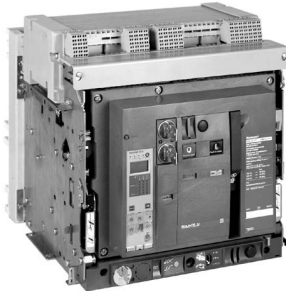

Masterpact NW

The Masterpact universal power circuit breaker offers a family of circuit protection products meeting the most common world standards, ANSI, CSA/UL and IEC. The basic design platform for each is common. The final result is CSA/UL, ANSI and IEC circuit breakers with the same basic external dimensions, features and accessories.

Full-Featured Performance

- Complete product offering
- Circuit breakers tested to show arc flash hazard risk category as referenced by NFPA70E
- 800 A to 6000 A frames, fixed and draw-out
- Rated for AC voltage systems through 600 V (635 V ANSI)
- Short-time withstand ratings up to 100 kA
- Cradle position indicator: connected, test and disconnected
- Simple, visual contact wear indicators
- Full complement of field-installable accessories common to all standards
- Four interchangeable Micrologic trip units to choose from
- Available PowerLogic™ based power metering and monitoring capabilities
- Available protective relay functions as defined by ANSI C37.2 and C37.90

The following charts show the Masterpact NW and NT ratings for ANSI and CSA/UL 489. For details, please refer to Catalog 0613CT0001.

Masterpact NW Circuit Breaker Ratings

Standard	ANSI C37 Certified/UL 1066 Listed																UL 489 Listed																									
	800–1600 A						2000 A				3200/4000 A Δ			4000/5000 A			800/1200/1600/2000 A				2500/3000 A		4000/5000/6000 A																			
Frame Rating	N1		H1		H2		H3		L1 □		L1F □		H1		H2		H3		L1 □		H2		H3		L1 □		N		H		L □		LF □		H		L □		H		L □	
Interrupting Current (kA RMS) 50/60 Hz	240 Vac		42	65	85	100	200	200	65	85	100	200	200	65	85	100	200	85	100	200	65	100	200	200	100	200	100	200	100	200	100	200	100	200	100	200	100	200	100	200		
	480 Vac		42	65	85	100	200	200	65	85	100	200	200	65	85	100	200	85	100	200	65	100	150	150	100	150	100	150	100	150	100	150	100	150	100	150	100	150	100	150		
	600 Vac		42	65	85	85	130	130	65	85	85	130	130	65	85	85	130	130	85	85	130	50	85	100	100	85	100	85	100	85	100	85	100	85	100	85	100	85	100	85	100	
Short-time Withstand Current (kA RMS)	42		65	85	85	30	22	65	85	85	30	22	65	85	85	100	85	85	100	42▲	65▲	30▲■	22	65	65	85	100															
Built-in Instantaneous Override (kA RMS ±10%)	◆		◆	◆	85	35◆	24	—	—	85	35	24	—	—	85	117	—	—	117	40	40	35▲■	24	65	65	75	75															
Close and latch rating (kA RMS)	42		65	40	40	25	22	65	40	40	25	22	65	40	40	40	85	75	40	40	40	25★	22	40	40	40	40															
Tested to show the arc flash hazard risk category as referenced by NFPA70E	—		—	—	—	—	Yes	—	—	—	—	Yes	—	—	—	—	—	—	—	—	—	—	Yes	—	—	—	—															
Breaking time	25–30 ms with no intentional delay (9 ms for L1, L1F, L and LF)																																									
Closing time	70 ms																																									
Sensor Rating	100–250 A 400–800 A 800–1600 A						1000–2000 A				1600–3200 A			2000–4000 A 2500–5000 A			100–250 A 400–800 A 600–1200 A 800–1600 A 1000–2000 A				1200–2500 A 1600–3000 A		2000–4000 A 2500–5000 A 3000–6000 A																			
Endurance Rating (C/O Cycles) With No Maintenance	Mechanical		12,500		2800		10,000				10,000			5k 1k			5,000			12,500▼ 2800▼				10,000		5,000		1,000		1,000		1,000		1,000		1,000		1,000		1,000		

- ▲ 24 kA RMS for 800 A circuit breaker frame with 100 A or 250 A sensor.
- 65 kA RMS for 2000 A.
- ◆ None except 24 kA RMS for 800 A circuit breaker frame with 100 A or 250 A sensor.
- ★ 40 kA RMS for 2000 A.
- ▼ The endurance rating for 2000 A, N/H/L/LF is 10,000 for mechanical and 1000 for electrical.
- Δ 4000 A standard width circuit breaker is not available in L1 interrupting rating code or drawout construction (fixed mounting only).
- Drawout mounted only.

Masterpact NT Circuit Breaker Ratings

Standard	ANSI C37 Certified/UL 1066 Listed						UL 489 Listed																															
	800 A						800 A				1200 A				1600 A ◇																							
Frame Rating	N1		N		H		L1		L		LF★		N		H		L1		L		LF★		N		H		L1		L									
Interrupting Current (kA RMS) 50/60 Hz	240 Vac		42		50		65		100		200		200		50		65		100		200		50		65		100		200									
	480 Vac		42		50		50		65		100		100		50		50		65		100		50		50		65		100									
	600 Vac		—		35		50		—		—		—		35		50		—		—		—		35		50		N/A		N/A							
Short-time Withstand Current (kA RMS)	42		35		35		10		10		10		10		35		35		10		10		10		35		35		10		10							
Built-in Instantaneous Override (kA RMS ±10%)	—		40		40		10		10		10		10		40		40		10		10		10		40		40		10		10							
Close and latch rating (kA RMS)	40		25		25		10		10		10		10		25		25		10		10		10		25		25		10		10							
Tested to show the arc flash hazard risk category as referenced by NFPA70E	—		—		—		—		—		Yes		—		—		—		—		—		Yes		—		—		—		—							
Breaking time	25–30 ms with no intentional delay																		25–30 ms with no intentional delay (9 ms for L and LF)																			
Closing time	< 50 ms																																					
Sensor Rating	100–250 A 400–800 A						100–250 A 400–800 A				600–1200 A				800–1600 A																							
Endurance Rating (C/O Cycles) With No Maintenance	Mechanical		12,500		2800		12,500				2800			12,500				2800																				

- ◇ Fixed-mounted only.
- ★ Drawout mounted only.



NWMPRRT

Masterpact NW/NT Circuit Breaker Remote Racking

Description	Cat. No.
Masterpact NW/NT Remote Racking Devices▽	NWNTMPRRT
Masterpact NW Remote Racking Device▽	NWMPRRT
Masterpact NT Remote Rackign Device▽	NTMPRRT
Mounting Bracket Kit for NW Remote Racking (contains 10 mounting brackets)●	S47100
Mounting Bracket Kit for NT Remote Racking (contains 10 mounting brackets)●	S47104
Control Unit for NW Remote Racking●	S47101
30 ft Control Cable for NW Remote Racking●	S47102
Drive Shaft for NW Remote Racking●	S47103
Drive Shaft for NT Remote Racking●	S47105

- ▽ Unit comes with 10 mounting brackets included.
- For replacement only.

Ground-Fault Protection GC-200 Ground-Fault Relay System

Class 931, 940, 9600

GC-200 Ground-fault Relay System

The GC-200 Ground-fault relay system protects a grounded distribution system from low-level arcing ground faults. The system includes the GC-200 relay, a sensor (current transformer) and optional GC DSP display and is used with a bolted pressure switch or circuit breaker to open a circuit upon detection of a ground fault.

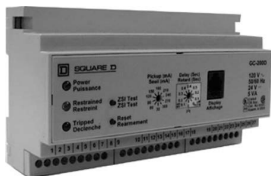

GC-200 Relays Features

- Five models with sensitivities suitable for main, feeder or branch circuits
- Adjustable Pickup and Time Delay settings
- I2t -- Inverse Time Characteristics
- ZSI -- Zone Selective Interlocking
- ZSI Push-to-Test with Signal Indication
- Two sets of Contacts (1 Form A ;10A @ 120Vac. and 1 Form C; 5A @ 120Vac.N/O, 1 N/C)
- Auxiliary Trip Input Terminals
- External Battery Backup Connection
- Small non-metallic enclosure mounts on DIN rail

GC DSP Display (Optional) Features

- LCD Back Lit Display
- Surface (Panel) Mounted
- Local Display of System Parameters
- "Fine tuning" Adjustment of Ground Fault Relay Settings
- Remote Testing of Ground Fault Relay
- Remote Resetting of Ground Fault Relay

Sensors

- Zero sequence sensing current transformers for all phases and neutral
- Several sizes of toroids and rectangular CTs
- Many are split-core or open frame for ease of installation.

Catalogue Number	Pickup Settings									
GC-200D	30A	90A	90A	120A	150A	180A	210A	240A	270A	300A
GC-200E	120A	240A	360A	480A	600A	720A	840A	960A	1080A	1200A

Catalogue Number	Time Delay Settings (Sec)					
All Types	Inst.	0.10	0.20	0.30	0.40	

Catalogue Number	Description	Price
GC-200D	30A - 300A Relay	
GC-200E	120A - 1200A Relay	
GC-DSP**	GC-200 Display	
VW3A1104R10	1m display cable	
VW3A1104R30	3m display cable	
VW3A1104R5	5m display cable	
VW3A1104R100	10m display cable	

** Note: GC12 12' cable shipped standard with GC DSP display units.



T3B Toroid Sensor



GT912 Rectangular Sensor

Relay Catalogue Number	Sensor Catalogue Number	Type	CT Ratio	Window Dimensions		Price
				IN	mm	
GC200C GC200D	T2A T3A T3AS T6A T6AS T9A	Toroid Toroid Toroid, split-core Toroid Toroid, split-core Toroid	1000:1	1.875 dia. 2.75 dia. 2.625 dia. 5.75 dia. 5.75 dia. 8.75 dia.	48 dia. 70 dia. 67 dia. 146 dia. 146 dia. 222 dia.	
	R713A R417A R826A	Rectangular		7.5 x 13.5 4.25 x 17.625 8 x 26.5	191 x 343 108 x 448 203 x 674	
All "A" type sensors above, plus:						
GC200E	RZ511 RZ521 RZ531 RZ535	Rectangular, Open Frame	1000:1 1000:1 1000:1 1000:1	4.5 x 11 4.5 x 21 4.5 x 31 4.5 x 35	114 x 280 114 x 534 114 x 788 114 x 890	
	RZ1011 RZ1021 RZ1031	Rectangular, Open Frame	1000:1 1000:1 1000:1	10.5 x 11 10.5 x 21 10.5 x 31	267 x 280 267 x 514 114 x 788	
	GT912 GT918 GT930	Rectangular, Open Frame	600:1 600:1 600:1	5.5 x 8.5 5.5 x 14.5 5.5 x 26.5	140 x 216 140 x 368 140 x 673	
	GT1218 GT1224 GT1230	Rectangular, Open Frame	600:1 600:1 600:1	8.5 x 14.5 8.5 x 20.5 8.5 x 26.5	216 x 368 216 x 521 292 x 673	
	GT1327 GT1330	Rectangular, Open Frame	600:1 600:1	9.5 x 24 9.5 x 27	241 x 610 241 x 686	
	GT1530	Rectangular, Open Frame	600:1	11.5 x 26.5	292 x 673	

DE3 CIRCUIT BREAKERS

Vigirex™ Ground-Fault Relay System

The Vigirex ground-fault relays, with associated sensors (current transformers), measure the residual current in an electrical installation to detect levels which may be damaging. When used for protection, they cause an associated circuit breaker or switch to interrupt the supply of power to the protected system. They may also be used for monitoring only, with output to an alarm. The product line includes fixed sensitivities from 30 mA to 1 A and adjustable sensitivities up to 30 A.

The Vigirex relays may be easily mounted on DIN rail or may be panel mounted in a meter cutout. Sensors for conductors range from a little more than an inch diameter toroids, to large rectangular sensors measuring 6 x 18 inches. The compact size of the relay and its sensor make it ideal for protection of OEM equipment as well as branch circuits.



RH99M



RH99P



PA50



SA200

Vigirex Ground-Fault Relays (cUL Listed)

Model	Delay	Reset	Control Voltage	Sensitivity	Catalogue No.
DIN Rail Mounted					
RH10M	Instantaneous	Manual	12–24 Vac/12–48 Vdc	30 mA 100 mA 300 mA 500 mA 1 A	56300 56302 56305 56306 56307
			110–130 Vac	30 mA 100 mA 300 mA 500 mA 1 A	56320 56322 56325 56326 56327
			220–240 Vac	30 mA 100 mA 300 mA 500 mA 1 A	56330 56332 56335 56336 56337
RH21M	Instantaneous or 60 mSec (2 settings)	Manual	12–24 Vac/12–48 Vdc 110–130 Vac 220–240 Vac	30 mA or 300 mA (2 settings)	56360 56362 56363
RH99M	Adjustable (9 settings): 0, 0.06, 0.15, 0.23, 0.31, 0.5, 0.8, 1.0, 4.5 sec	Manual	12–24 Vac/12–48 Vdc 110–130 Vac 220–240 Vac	Adjustable (9 settings): 0.03, 0.1, 0.3, 0.5, 1, 3, 5, 10, 30 A	56370TD 56372TD 56373TD
		Automatic	12–24 Vac/12–48 Vdc 110–130 Vac 220–240 Vac		56390TD 56392TD 56393TD
Panel Mounted					
RH10P	Instantaneous	Manual	12–24 Vac/12–48 Vdc	30 mA 100 mA 300 mA 500 mA 1 Amp	56400 56402 56405 56406 56407
			110–130 Vac	30 mA 100 mA 300 mA 500 mA 1 Amp	56420 56422 56425 56426 56427
			220–240 Vac	30 mA 100 mA 300 mA 500 mA 1 A	56430 56432 56435 56436 56437
RH21P	Instantaneous or 60 mSec (2 settings)	Manual	12–24 Vac/12–48 Vdc 110–130 Vac 220–240 Vac	30 mA or 300 mA (2 settings)	56460 56462 56463
RH99P	Adjustable (9 settings): 0, 0.06, 0.15, 0.23, 0.31, 0.5, 0.8, 1.0, 4.5 sec	Manual	12–24 Vac/12–48 Vdc 110–130 Vac 220–240 Vac	Adjustable (9 settings): 0.03, 0.1, 0.3, 0.5, 1, 3, 5, 10, 30 A	56470TD 56472TD 56473TD
		Automatic	12–24 Vac/12–48 Vdc 110–130 Vac 220–240 Vac		56490TD 56492TD 56493TD

Sensors for Vigirex Ground-Fault Relays

Sensors	Type	Inside Diameter		Catalogue No.
		IN	mm	
Closed Toroids, type A	TA30	1.18	30	50437
	PA50	1.97	50	50438
	IA80	3.15	80	50439
	MA120	4.72	120	50440
	SA200	7.87	200	50441
	GA300	11.81	300	50442
Split toroids, type OA	POA▲	1.81	46	50485
	GOA▲	4.33	110	50486
Rectangular sensors	280 x 115	11.02 x 4.53	280 x 115	56053
	470 x 160	18.50 x 6.30	470 x 160	56054

▲ POA and GOA are not cUL recognized

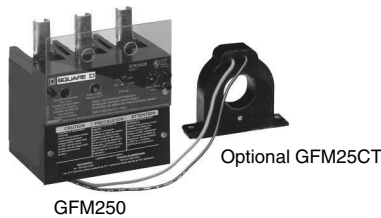

The Micrologic ground-fault module (GFM) is a CSA certified and UL Listed circuit breaker accessory which protects equipment from damage caused by ground faults. It is an add-on module which, when connected to a PowerPact H- or J-frame thermal-magnetic circuit breaker only, provides ground-fault sensing and ground-fault relay functions.

HD/JD Add-on Ground-fault Module Features:

- Adjustable ground-fault pickup levels
- Adjustable ground-fault time delays
- Integral ground fault push-to-test feature and ground-fault indicator
- All GFMs are supplied for I-Line[®] mounting, easily convertible to unit mount by removing the I-Line brackets
- Fault-powered (through the sensing current transformer) for electronics, shunt trip, and integral test feature.
- Optional neutral current transformer GFM25CT for 3-phase 4-wire applications. Refer to instructions for proper installation
- Shunt trip S29382 (12 Vdc): is required for circuit breaker. This may be factory-installed (suffix SN) or field-installed

NOTE: Ground-fault modules cannot be used for alarming only.

Module/Enclosure Selection Chart ▲

Companion Circuit Breaker Prefix	Catalogue Number ▲	Enclosure Space Required		Ground-fault Pickup Adjustment Range
		I-Line Switchboard		
HD, HG, HJ, HL	GFM150HD	LA		20–100 A
JD, JG, JJ, JL	GFM250JD	LA		40–200 A

Accessories

H & J	GFM25CT	Optional Neutral Current Transformer (required for 4-wire systems)		
-------	---------	--	--	--

▲ At 250 A, the GFM250JD can be used with 80% rated circuit breakers only.

Earth Leakage Module (ELM) for PowerPact H- and J-Frame MCCBs

The Earth Leakage Module (ELM) is an add-on module which, when connected to a PowerPact H- or J-frame MCCB, provides low-level ground-fault sensing and ground-fault relay functions.

Because these ELMs are highly sensitive (30 mA to 3 A), they provide much greater protection than GFMs (20 Amps to 200 Amps sensitivity). The ELMs provide greater protection of control circuits and other sensitive equipment. The associated circuit breaker must have a 48 Vdc shunt trip, which may be field-installed (kit S29392) or factory-installed (suffix –SP) in the H- or J-Frame circuit breaker.

Add-on Earth Leakage Module (ELM) Features:

- Adjustable ground-fault pickup levels as low as 30 mA
- Adjustable ground-fault time delays from instantaneous to 500 msec (Time delay can be applied to the 30 mA setting)
- Integral ground fault push-to-test feature
- Ground-fault indicator (LED for local status; contacts for remote indication)
- All ELMs are supplied for I-Line[™] mounting and are easily convertible to unit-mount by removing the I-Line brackets
- Three poles; 240 to 600 Vac maximum: 3-wire applications only (no neutral)
- Line-power obtained through internal bus to provide power for electronics, shunt trip, and integral test feature.
- A shunt trip is required in the circuit breaker; it may be field-installed or factory-installed in the PowerPact H and J circuit breakers.
- UL 1053 – Ground-fault Sensing and Relaying Equipment

ELM Selection Chart■

Companion Circuit Breaker◆	Enclosure Space Required I-Line Switchboard	Pick-Up Adjustment Range	Catalog Number
HD, HG, HJ, HL	LA	30 mA–3 A	ELM150HD
JD, JG, JJ, JL	LA	30 mA–3 A	ELM250JD

- At 250 A, the ELM250JD can be used with 80% rated circuit breakers only.
- ◆ For Factory Installation of ELM Module: For termination designation (3rd letter of catalog number) use ONLY "M". Add factory installed 48 Vdc shunt trip (suffix SP) to breaker plus suffix VL or VM. Use VL for H frame. Use VM for J frame.



I-Line[™] J-Frame with ELM installed

Dimensions and Shipping Weights

Miniature and Molded Case Circuit Breakers

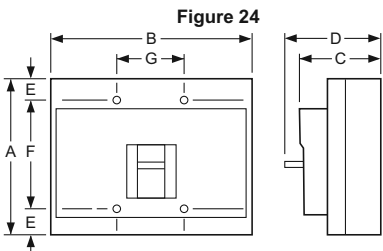
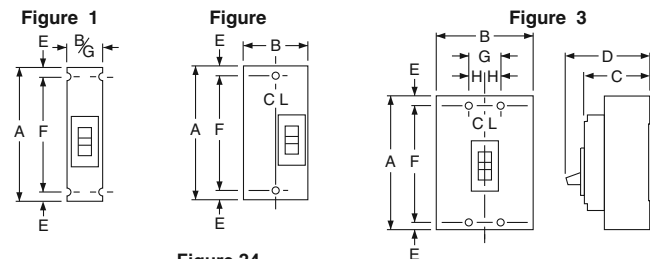
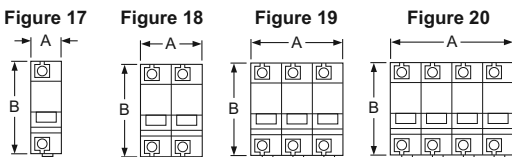
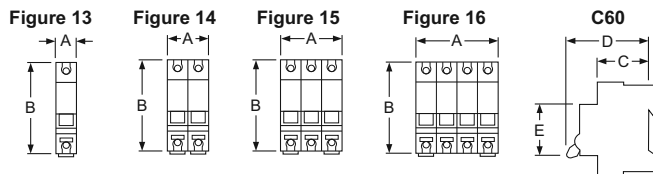
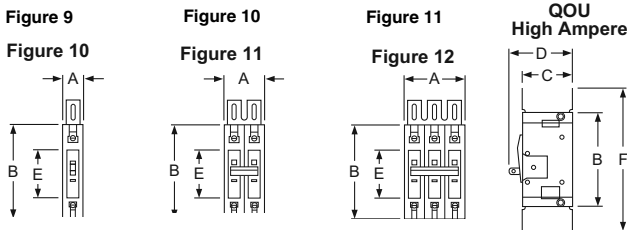
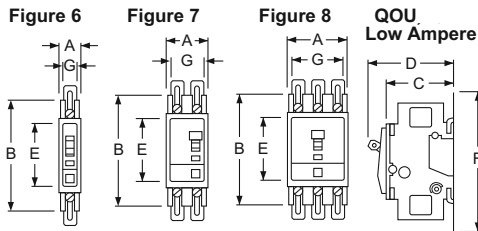
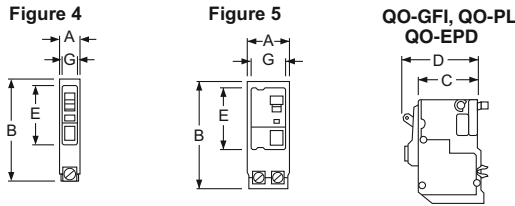
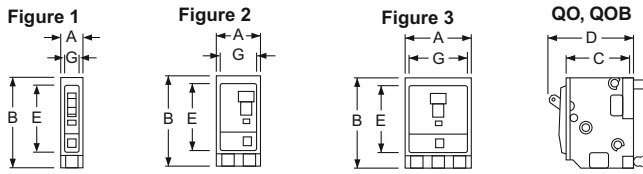

QO™, QOU, Multi 9™ Circuit Breakers

Circuit Breaker Catalogue No. Prefix	No. Poles	Fig. No.	Dimensions—Inches						
			A	B	C	D	E	F	G
QO, QOB	1	1	0.75	3.00▲	2.31	2.91	2.25	...	0.59
	2	2	1.50	3.00▲	2.31	2.91	2.25	...	1.34
	3	3	2.25	3.00▲	2.31	2.91	2.25	...	2.09
QOB-VH 150 A QOB-VH 110–150 A	2	2	3.0	5.72	2.53	4.90	3.78	...	2.85
	3	3	4.50	5.72	2.53	4.90	3.78	...	4.35
QO-PL QO-GFI QO-EPD	1	4	0.75	4.12■	2.31	2.91	2.25	...	0.59
	2	5	1.50	4.12■	2.31	2.91	2.25	...	1.34
	3	5	2.25	4.12■	2.31	2.91	2.25	...	2.09
QOU Low Ampere	1	6	0.75	4.05♦	2.38	2.98	2.25	5.00▼	0.62
	2	7	1.50	4.05♦	2.38	2.98	2.25	5.00▼	1.37
	3	8	2.25	4.05★	2.38	2.98	2.25	5.00△	2.12
QOU High Ampere	1	9	0.75	4.45	2.37	2.96	2.25	6.78	...
	2	10	1.50	4.45	2.37	2.96	2.25	6.78	...
	3	11	2.25	4.45	2.37	2.96	2.25	6.78	...
Multi 9™ C60	1	13	0.71	3.19	1.73	2.76	1.77	—	—
	2	14	1.42	3.19	1.73	2.76	1.77	—	—
	3	15	2.13	3.19	1.73	2.76	1.77	—	—
	4	16	2.84	3.19	1.73	2.76	1.77	—	—

- ▲ 35–70 A is 3.12 in; 80–100 A 2-pole and 70–100 A 3-pole are 3.50 in.
- QO-PL is 4.55 in.
- ♦ 80–100 A 1-pole and 80–125 A 2-pole are 4.45 in.
- ★ 70–100 A 4.45 in.
- ▼ 80–100 A 1-pole and 80–125 A 2-pole are 6.78 in.
- △ 70–100 A is 6.78 in.

QB, QD, QG, QJ, Q4, FA, FI, KI, LA, LH Circuit Breakers

Circuit Breaker Catalogue No. Prefix	No. Poles	Fig. No.	Dimensions—Inches							
			A	B	C	D	E	F	G	H
QB, QD, QG, QJ	2	22	6.47	3.00	3.02	3.93	□	4.25
	3	23	6.47	4.50	3.02	3.93	□	4.25	1.50	0.75
FAL, FHL	1	21	6.00	1.50	3.16	4.13	0.44	5.13	1.50	...
	2	22	6.00	3.00	3.16	4.13	0.44	5.13
	3	23	6.00	4.50	3.16	4.13	0.44	5.13	1.50	0.75
FIL, KIL	2 & 3	23	8.00	4.50	3.66	4.75	0.44	7.13	1.50	0.75
Q4L, LAL, LHL	2 & 3	23	11.00	6.00	4.06	5.84	0.88	9.25	2.00	1.00

□ Dimensions E are 1.59 in at ON end and 0.63 in at OFF end.

Shipping Weights ◊

Frame Size	Approx. Shipping Weight (Lbs.)	Frame Size	Approx. Shipping Weight (Lbs.)
FAL, FHL 1P	2	KIL	9
FAL, FHL 2P	3	LAL, LHL	15
FAL, FHL 3P	5	LIL LXIL	25
FIL	8	Q4L	15
QB, QD, QG, QJ	4		

◊ All weights are for 3P circuit breakers unless otherwise noted.

Dimensions and Shipping Weights Molded Case Circuit Breakers

Figure 25

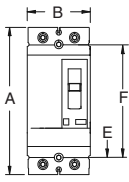

Figure 26

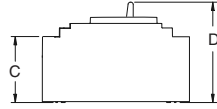
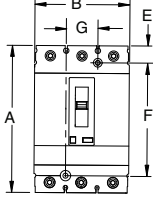

Figure 27

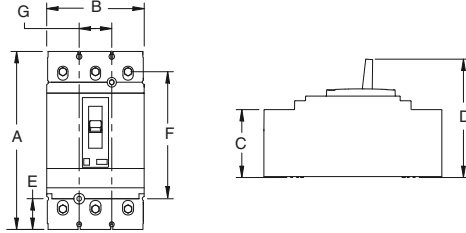

Figure 28

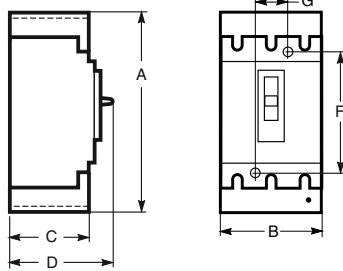

Figure 29

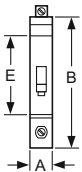

Figure 30

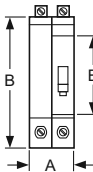

Figure 31

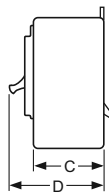
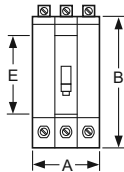

Figure 32

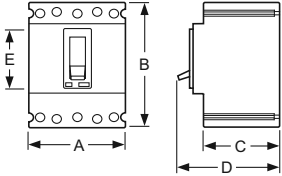

Figure 33

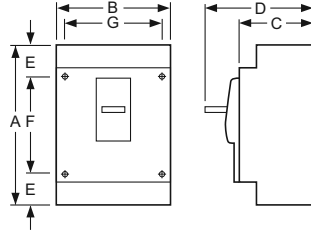
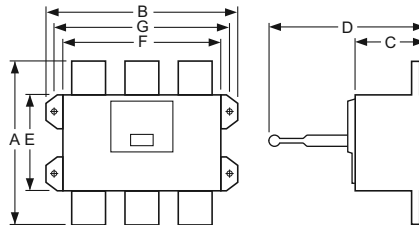

Figure 34



HD, HG, HJ, HL, HR, JD, JG, JJ, JL, JR, LG, LJ, LL, and LR Circuit Breakers

Circuit Breaker Cat. No. Prefix	No. of Poles	Fig. No.	Dimensions — Inches						
			A	B	C	D	E	F	G
HD, HG, HJ, HL, HR	2*	25	6.40	2.74	2.87	4.36	0.74	4.92	—
JD, JG, JJ, JL, JR	3	26	6.40	4.12	2.87	4.36	0.74	4.92	1.38
LG, LJ, LL, LR	3	27	7.52	4.12	2.87	5.00	1.30	4.92	1.38
	3	28	13.38	5.51	3.75	6.61	2.22	7.87	1.77

* - Only HD and HG are in 2P module. The HJ, HL and HR 2P breakers are in 3P modules

ED, EG and EJ Circuit Breakers

Circuit Breaker Catalogue No. Prefix	No. of Poles	Fig. No.	Dimensions — Inches				
			A	B	C	D	E
ED, EG, EJ	1	29	0.98	5.66	3.09	4.05	3.32
	2	30	1.96	5.66	3.09	4.05	3.32
	3	30	2.94	5.66	3.09	4.05	3.32
GJ	3	32	3.54	4.72	2.76	3.94	2.20

MG, MJ, PG, PJ, PL, RG, RJ and RL Circuit Breakers

Circuit Breaker Cat. No. Prefix	No. of Poles	Fig. No.	Dimensions — Inches						
			A	B	C	D	E	F	G
MG, MJ (800 A and below)	2, 3	33	12.86	8.27	5.77	8.05	2.49	7.87	7.83
PG, PJ, PK, PL (1000–1200 A)	2, 3	33	16.16	8.27	5.77	8.05	4.19	7.87	7.83
RG, RJ, RL	2, 3	34	16.24	16.54	6.63	14.49	8.73	14.25	15.35

Shipping Weights▲

Frame Size	Approx. Shipping Weight (Lbs.)	Frame Size	Approx. Shipping Weight (Lbs.)
HD, HG, HJ, HL 2P	4	JD, JG, JJ, JL, JR	5
HD, HG, HJ, HL, HR 3P	5	LD, LG, LJ, LL, LR	14
ED, EG, EJ 1P	2	MG, MJ	29
ED, EG, EJ 2P	3	PG, PJ, PK, PL	32
ED, EG, EJ 3P	4	RG, RJ, RK, RL (Without RLTB)	52

▲ All weights are for 3P circuit breakers unless otherwise noted.

Circuit Breaker Enclosures

Enclosures

Class 610

Circuit breaker enclosures are UL Listed, CSA Certified and are suitable for use as service entrance equipment, except as footnoted. The short circuit current rating of an enclosed circuit breaker is equal to the interrupting rating at the supply voltage marked on the circuit breaker installed, except as footnoted. Exceptions and restrictions are footnoted. Breakers are ordered and shipped separately for field installation. For enclosure accessories, refer to page DE3-58.

Circuit Breaker Enclosures

Circuit Breaker			Enclosure		
Cat. No. Prefix	Rating	Poles	Cat. No.	Cat. No.	Cat. No.
			NEMA 1 Flush	NEMA 1 Surface	NEMA 3R▲
FAL, FHL	15-100	1, 2, 3	FA100F	FA100S	FA100RB
QBL, QDL, QGL, QJL	100-225	2, 3	Q23225NFC■	Q23225NSC■	Q23225NRBC■
HDL, HGL, HJL, HLL	15-150		J250F◆★▼	J250S◆★▼	J250R◆★▼
JDL, JGL, JLL, JLL	150-250	3	—	HD100S△□◆▼☆	—
HDL	15-100 A		—	JD250S★□△◆▼	—
JDL	150-250 A		—	—	—
LAL, LHL, Q4L	125-400	2, 3	LA400F	LA400S	LA400R
LAL	125-400 A	3	—	LA400LS□★●	—
MGL, MJL, PGL, PJJ, PKL, PLL	300-800	2, 3	—	M800S▽○	M800R▽■
PGL, PJJ, PKL, PLL*	600-1200	2, 3	—	P1200S○	P1200R■
			NEMA 12/3R, 12K		
			NEMA 4, 4X, 5, 3, 3R Stainless Steel ^u	With Knockouts (NEMA 12K)	Without Knockouts ^o (NEMA 12/3R, 5)
FAL, FHL	15-100	1, 2, 3	FA100DS	FA100AWK	
HDL, HGL, HJL, HLL	15-150	2, 3	J250DS◆★▼	J250AWK◆★▼	
JDL, JGL, JLL, JLL	150-250		J250SS◆★▼		
LAL, LHL, Q4L	125-400	3	LA400DS	LA400AWK	
LDL, LGL, LJL, LLL, LRL	250-600		—	L600AWK ^w	
LGL, LLL, LRL	250-600		—	L600AWKMC	
MGL, MJL, PGL, PJJ, PKL, PLL	300-800	2, 3	M800DS○	M800AWK○	
PGL, PJJ, PKL, PLL*	250-1200		M800SS○		
			Nema 7 ^z Cast Aluminum	Nema 9 [†] Cast Aluminum	
JDL, JGL ^z ◆ [‡]	150-250 A	2, 3	J225X	J225Y	

- ▲ Enclosures with NRB or RB suffix have provisions for 3/4" through 2-1/2" bolt-on hubs in top endwall. Enclosures with R suffix have blank endwalls and require field cut opening.
- Factory installed groundable neutral assembly includes (2) ground lugs and (2) neutral lugs. Equipment ground kit is also included.
- ◆ Accepts standard rated 80% breakers. Not rated at 100%.
- ★ Maximum short circuit rating is 25 kAIR at 600 Vac, 65 kAIR at 480 Vac, 125 kAIR at 240 Vac.
- ▼ Earth Leakage Module and Ground Fault Module are not compatible with these enclosures.
- △ Maximum short circuit rating is 25 kAIR, 240 Vac.
- Order service ground kit PKOGTA2 if required.
- ◇ Maximum short circuit rating is 18 kAIR, 480 Vac and 240 Vac.
- ☆ Copper wire only.
- ▽ When using a CT in the M800S and R enclosure the unit will no longer accommodate a 200% neutral solution.
- CE certified per IEC60439-1, IP20D, PE type TN-C or TN-S
- * Accepts MGL or MJL standard rated (80%) breakers. Accepts PGL, PJJ or PLL circuit breakers rated 80% (1200 A maximum) or 100% rated breakers, (800A maximum).
- ◇ CE certified per IEC60439-1, IP24D, PE type TN-C or TN-S
- Suitable for rainproof Type 3R application by removing drain screw from bottom endwall.
- CE certified per IEC60439-1, IP56, PE type TN-C or TN-S
- NEMA 7—Indoor Hazardous Locations—Division 1 and 2, Class I, Groups C and D; Class II, Groups E, F, and G; Class III.
- ◆ 80% rated circuit breakers only; SCCR 65 kA @ 240 Vac, 25 kA @ 480 Vac, 18 kA @ 600 Vac.
- ‡ Not UL Listed due to wire bending space.
- † NEMA 9—Indoor Hazardous Locations—Division 1 and 2, Class II, Groups E, F, and G; Class III.
- Has a tapped 2-1/2 in. conduit opening on top and bottom end wall
- ^u Short circuit current rating is 30 k AIR at 480 Vac.
- ^v J250SS and M800SS are 316 Grade Stainless Steel Circuit Breaker Enclosures. Type 316 stainless steel circuit breaker enclosures offer superior corrosion resistance to a wider range of chemicals than Type 304 stainless steel enclosures. Type 316 better resists chloride and is often used in marine, waste treatment and transportation applications.
- ^w cULus marked enclosure. For factory installed viewing window, add suffix VW. For enclosure suitable for use as Service Equipment use Cat. No. CL600NAWK (neutral SN1000MA will be factory installed and bonded)

Accessories Page DE3-58
 Dimensions Page DE3-58

DE3 CIRCUIT BREAKERS



FA100S



FA100RB



FA100DS



FA100X



FA100Y

Circuit Breaker			Type 7 * Cast Aluminum	Type 9 ■ Cast Aluminum
Catalogue Number Prefix	Ampere Rating	Number of Poles	Enclosure Catalogue No.	Enclosure Catalogue No.
FAL, FHL▲	15-60	1, 2, 3	FA060X▼	FA060Y①
	15-100	1, 2, 3	FA100X▼	FA100Y①

- * NEMA Type 7 – Indoor Hazardous Locations – Class I, Groups C and/or D, Divisions 1 or 2.
- NEMA Type 9 – Indoor Hazardous Locations – Class II, Groups E and/or G, Class III, Divisions 1 or 2.
- ▼ Suitable for rainproof applications—includes PKDB-1 breather and drain kit.
- ▲ Use 75°C Cu conductors only.
- ① Not CSA certified.

Note: Circuit breaker enclosures not to be used with MAG-GARD breakers.

Circuit Breaker Enclosures

Enclosure Accessories and Dimensions

Class 610

Accessories

Insulated Groundable Neutral Assembly

Circuit Breaker		Neutral Assembly For Use With			Terminal Lug Data—Total Available (Line plus Load) AWG/kcmil
Cat. No. Prefix	Ampere Rating	NEMA 1 & 3R	NEMA 4, 4X, 5, 12 & 12K	NEMA 7 & 9	
		Cat. No.	Cat. No.	Cat. No.	
FAL, FHL FAL, FHL	100 100	SN100FA —	SN100FA —	— 100SNA	(4) 14–1/0 Cu or (4) 12–1/0 Al FA060X/Y—(1) 14–6 Cu, plus (1) 14–4 Cu FA100X/Y—(1) 14–3 Cu, plus (1) 14–4 Cu
HDL,HGL,HJL,HLL HDL,HGL,HJL,HLL JDL,JGL,JJL,JLL	15–100 125–150 150–250	SN100FA SN400LA SN400LA	SN100FA SN400LA SN400LA	— 225SNA —	(4) 14–1/0 Cu or (4) 12–1/0 Al (2) 1–600 or (4) 1–250 Al/Cu, plus (2) 4–300 Al/Cu (2) 1–600 or (4) 1–250 Al/Cu, plus (2) 4–300 Al/Cu
LAL, LHL, Q4L	400	400SN	SN400LA	—	(2) 1–600 or (4) 1–250 Al/Cu, plus (2) 4–300 Al/Cu
LDL, LGL, LJL, LLL, LRL	250–400	—	SN400LA SNC400LX	—	(2) 1–600 or (4) 1–250 Al/Cu, plus (2) 4–300 Al/Cu (2) 1–600 or (4) 1–250 Al/Cu, plus (2) 4/0 Cu
LDL, LGL, LJL, LLL, LRL	250–600	—	SN1000MA SNC800LX	—	(6) 3/0–500 Al/Cu, plus (1) 1–4/0 Al/Cu (4) 2–600 Cu, plus (1) 2–4/0 Cu
MGL, MJL ▼	300–800 A	AL800SN	AL800SN	—	(6) 3/0–500 Al/Cu, plus (2) 6–250 Al/Cu
PG, PJL, PKL, PLL □	250–1200 A	SN1200	SN1200	—	(8) 750 Max. Al/Cu, plus (2) 350 Max. Al/Cu

- ◆ All Cu neutral assembly.
- ▼ For 200% neutral applications order Jumper kit SN800SNI and 2 of kit SN1200.
- For applications with integral ground fault protection order Neutral Mounting Kit S33576MK and Neutral CT S33576 (400–1200A only).

Equipment Ground Kits

Circuit Breaker Cat. No. Prefix	Ground Bar Cat. No.	Number of Terminals	Conductors Per Terminal	Wire Range AWG/kcmil	Price
QBL, QDL, QGL, QJL FAL, FHL, LAL, LHL, Q4L	PKOGTA2	2	1	10–2/0 Cu or 6–2/0 Al	
HDL,HGL,HJL,HLL,JDL,JGL,JJL,JLL	PKOGTJ250	2	1	6–300 Al/Cu	
LDL, LGL, LJL, LLL, LRL MGL, MJL PGL, PJL, PKL, PLL	PKOGTA4	4	1	6–250 Al or Cu	

Dimensions (inches)

Cat. No.	Series	Approximate Dimension					
		H		W		D	
		in.	mm	in.	mm	in.	mm
FA060X	E1	16.00	406	9.88	251	7.00	178
FA060Y	E1	16.00	406	9.88	251	7.00	178
FA100AWK	E2	19.50	495	9.13	232	4.88	124
FA100DS	E2	19.50	495	9.13	232	4.88	124
FA100F	E2	19.50	495	9.88	251	4.13	105
FA100RB	E2	18.00	457	8.88	226	4.88	124
FA100S	E2	18.13	461	8.63	219	4.13	105
FA100X	E1	16.00	406	9.88	251	7.00	178
FA100Y	E1	16.00	406	9.88	251	7.00	178
J250F	A01	32.40	823	15.40	391	6.00	152
J250S	A01	31.36	797	14.36	365	6.00	152
J250R	A01	31.05	789	14.47	368	6.28	160
J250DS, J250SS	A01	32.26	819	9.72	247	7.94	202
J250AWK	A01	32.26	819	9.72	247	7.94	202
LA400AWK	E2	42.25	1073	13.75	349	7.25	184
LA400DS	E2	42.25	1073	13.75	349	7.25	184
LA400F	E2	45.63	1159	16.50	419	6.50	165
LA400R	E2	44.00	1118	15.38	391	7.88	200
LA400S	E2	44.50	1130	15.38	391	6.50	165
L600AWK	E3	57.50	1461	20.38	518	8.25	210
M800S	A1	40-3/8	1025.52	21	533.4	9-3/4	247.65
M800R	A1	40-3/8	1025.52	21	533.4	9-3/4	247.65
M800DS, M800SS	A1	40-7/8	1036.96	20-3/4	527.05	9-1/2	241.3
M800AWK	A1	40-7/8	1036.96	20-3/4	527.05	9-1/2	241.3
P1200S	A1	52-1/8	1323.98	21	533.4	9-3/4	247.65
P1200R	A1	52-1/8	1323.98	21	533.4	9-3/4	247.65
P1200AWK	A1	53	1346.20	20-3/4	527.05	9-1/2	241.3
Q23225NFC	E3	26.25	667	9.88	251	4.75	121
Q23225NRBC	E3	26.25	667	9.88	251	5.50	140
Q23225NSC	E3	26.25	667	9.88	251	4.75	121

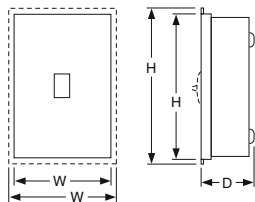

Type 1
Q2, FA, J, LA, MG, PG

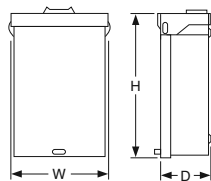

Type 3r
Q2, FA, J, LA, MG, PG

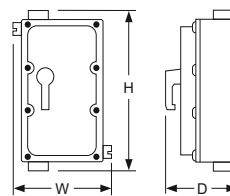

Type 7, Type 9
FA

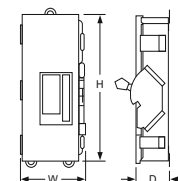

Type 4, 4X, 5, 12, 12K
FA, J, LA, L, MG, PG

Photovoltaic Circuit Breakers and Switches

Class 611 / Refer to Catalog 0611CT1302 600 Vdc and 1000 Vdc PV Circuit Breakers and Switches



The UL listed thermal-magnetic molded case circuit breakers and switches shown below are specifically designed for use in PV applications, rated at 50°C, offering grounded or ungrounded configurations.

The products are fully tested and calibrated under the PV UL489B standard.

The products come ready to install, including specially designed serial connectors for optimal thermal response, and adapted terminal covers for optimal isolation. Circuit Breakers come 100% rated for ease of use and selection.

These two new frames are fully compatible with the current line of PowerPact accessories, from aux contacts and shunt trips to motor operators and rotary handles.

PV Molded Case Circuit Breakers

Ampere Rating	600 Vdc (3 poles)		1000 Vdc (4 poles)	
	Ungrounded	Grounded	Ungrounded	Grounded
	Part Number	Part Number	Part Number	Part Number
50	TGL36050L	TGL36050K	TBL41050L	TBL41050K
60	TGL36060L	TGL36060K	TBL41060L	TBL41060K
70	TGL36070L	TGL36070K	TBL41070L	TBL41070K
80	TGL36080L	TGL36080K	TBL41080L	TBL41080K
100	TGL36100L	TGL36100K	TBL41100L	TBL41100K
125	TGL36125L	TGL36125K	TBL41125L	TBL41125K
150	TGL36150L	TGL36150K	TBL41150L	TBL41150K
175	TGL36175L	TGL36175K	TBL41175L	TBL41175K
200	TGL36200L	TGL36200K	TBL41200L	TBL41200K
225	UGL36225L	UGL36225K	UCL41225L	UCL41225K
250	UGL36250L	UGL36250K	UCL41250L	UCL41250K
300	UGL36300L	UGL36300K	UCL41300L	UCL41300K
350	UGL36350L	UGL36350K	UCL41350L	UCL41350K
400	UGL36400L	UGL36400K	UCL41400L	UCL41400K
450	UGL36450L	UGL36450K	UCL41450L	UCL41450K
500▲	N/A	UGL36500G	UCL41500J	UCL41500G

▲ 500 A 80% rated.

PV Circuit Breaker Max. Interrupting Ratings

Frame	600 Vdc	1000 Vdc
T-Frame	10 kA	3 kA
U-Frame	10 kA	5 kA

Circuit Breaker Numbering

Brand	Frame	Rating	Termination	Poles	Voltage	Amperage	Grounding	Suffix Code	Suffix Code
	T Frame T: T-Frame U: U-Frame	G Rating B: 3 kA C: 5 kA G: 10 kA	L Termination L: Lugs Line/Load Side F: Bus Bar S: Rear Connected	3 Poles 3: 3P 4: 4P	6 Voltage 6: 600 Vdc 1: 1000 Vdc	0 5 0 Amperage 050: 50 A 060: 60 A 070: 70 A 080: 80 A 100: 100 A 125: 125 A 150: 150 A 175: 175 A 200: 200 A 225: 225 A 250: 250 A 300: 300 A 350: 350 A 400: 400 A 450: 450 A 500: 500 A	G Grounding G: Grounded, 80% rated (500 A Only) J: Ungrounded, 80% rated (500 A Only) K: Grounded, 100% rated L: Ungrounded, 100% rated	A B Accessory Suffix Cells (See page DE3-60)	S A Accessory Suffix Cells (See page DE3-60)

PV Molded Case Non-Automatic Switches

Ampere Rating	600 Vdc (3 poles)		1000 Vdc (4 poles)	
	Ungrounded	Grounded	Ungrounded	Grounded
	Part Number	Part Number	Part Number	Part Number
100	TBL36000JZ10	TBL36000GZ10	TBL41000JZ10	TBL41000GZ10
150	TBL36000JZ15	TBL36000GZ15	TBL41000JZ15	TBL41000GZ15
200	TBL36000JZ20	TBL36000GZ20	TBL41000JZ20	TBL41000GZ20
250	UDL36000JZ25	UDL36000GZ25	UDL41000JZ25	UDL41000GZ25
300	UDL36000JZ30	UDL36000GZ30	UDL41000JZ30	UDL41000GZ30
400	UDL36000JZ40	UDL36000GZ40	UDL41000JZ40	UDL41000GZ40
500	UDL36000JZ50	UDL36000GZ50	UDL41000JZ50	UDL41000GZ50

PV Switches Withstand Ratings

Frame	600/1000 Vdc
T-Frame	3 kA
U-Frame	7.5 kA

Switch Numbering

Brand	Frame	Rating	Termination	Poles	Voltage	Amperage	Grounding	Trip System	Suffix Code	Suffix Code
	T Frame T: T-Frame U: U-Frame	D Rating B: 3 kA D: 7.5 kA	L Termination L: Lugs Line/Load Side F: Bus Bar S: Rear Connected	3 Poles 3: 3P 4: 4P	6 Voltage 6: 600 Vdc 1: 1000 Vdc	0 0 0 Amperage 000: Switch	G Grounding G: Grounded, 80% rated J: Ungrounded, 80% rated	Z 1 0 Trip System—## (Z: Non-Automatic Switch) (##: Amperage Rating) Z10: 100 A Z15: 150 A Z20: 200 A Z25: 250 A Z30: 300 A Z40: 400 A Z50: 500 A	A B Accessory Suffix Cells (See page DE3-60)	S A Accessory Suffix Cells (See page DE3-60)

DE3 CIRCUIT BREAKERS

Photovoltaic Circuit Breakers and Switches

Factory Installed Accessories

Class 611 / Refer to Catalog 0611CT1302

Auxiliary Switches

Contacts	Factory-Installed Suffix	Field-Installable Kit No.	Kit Qty.
1A/1B Standard	AA	S29450	1
2A/2B Standard	AB	S29450	2
3A/3B Standard▲	AC	S29450	3
1A/1B Low-Level (Gold)	AE	S29452	1
2A/2B Low-Level (Gold)	AF	S29452	2
3A/3B Low-Level (Gold)▲	AG	S29452	3

▲ U-Frame only.

Alarm/Overcurrent Trip Switches

Suffix	Switch	Kit No.	Kit Qty.
PowerPact T-Frame			
BC	Alarm Switch	S29450	1
BH	Alarm Switch, Low-Level	S29452	1
BD	Overcurrent Trip Switch, Standard	S29450	1
	SDE Actuator	S29451	1
BJ	Overcurrent Trip Switch, Low-Level	S29452	1
	SDE Actuator	S29451	1
BE	Alarm Switch and Overcurrent Trip Switch, Standard	S29450	2
	SDE Actuators	S29451	2
BK	Alarm Switch and Overcurrent Trip Switch, Low-Level	S29452	2
	SDE Actuators	S29451	2
PowerPact U-Frame			
BC	Alarm Switch	S29450	1
BH	Alarm Switch, Low-Level	S29452	1
BD	Overcurrent Trip Switch, Standard	S29450	1
BJ	Overcurrent Trip Switch, Low-Level	S29452	1
BE	Alarm Switch and Overcurrent Trip Switch, Standard	S29450	2
BK	Alarm Switch and Overcurrent Trip Switch, Low-Level	S29452	2

Shunt Trips

Voltage	Shunt Trip (MX)	
	Factory-Installed Suffix	Field-Installable Kit No.
120 Vac	SA	S29386
24 Vdc	SO	S29390
48 Vdc	SP	S29392
125 Vdc	SR	S29393

Rotary Operated Handles

Device	Description	Factory Installed Suffix	T-Frame	U-Frame
			Field Installable Kit No.	Field Installable Kit No.
Direct Mounted	Standard Handle Black	RD10	S29337	S32597
Door Mounted	Standard Black Handle	RE10	S29338	S32598

Locks

Device	Description	Factory Installed Suffix	T-Frame	U-Frame
			Field Installable Kit No.	Field Installable Kit No.
Handle Padlocking Device	Handle Padlock, ON or OFF	YP	S29371	S32631

NOTE: For a complete list of Field installable accessories and details, including also motor operator (electrical only) and locks, refer to accessories information for the PowerPact, J-Frame (compatible with T-Frame) and L-Frame (Compatible with U-Frame). Or consult Photovoltaic offer catalog 0611CT1302.

PV Unit Mount Terminal Covers

Choose termination "L" for having the termination kit factory installed with the breaker (Lugs, Term Covers, Serial Connectors)

Frame	Description ▲	Poles	Configuration				Field Installable Catalog No.
			Ungrounded		Grounded		
			Top	Bottom	Top	Bottom	
T-Frame	Long Terminal Cover (3P)	3	X				S35175
	Long Terminal Cover (3P/1SC)	3		X	X	X	S35176
	Long Terminal Cover (4P)	4		X			S35177
	Long Terminal Cover (4P/2SC)	4	X		X		S35178
	Long Terminal Cover (4P/1SC)	4				X	S35179
U-Frame	Long Terminal Cover (3P)	3	X				S32593
	Extended Term Cover (3P/1SC)	3		X	X	X	S38291
	Long Terminal Cover (4P)	4		X			S32594
	Extended Term Cover (4P/2SC)	4	X		X		S38293
	Extended Term Cover (4P/1SC)	4				X	S38294

▲ P: Poles, SC: Serial connector.

PV Rear Connection Terminal Covers and Connectors

Choose termination "S" for having the termination kit included with the breaker (Rear Connectors, Term Covers, Serial Connectors)

Frame	Description ◆	Poles	Configuration				Field Installable Catalog No.
			Ungrounded		Grounded		
			Top	Bottom	Top	Bottom	
T-Frame	Short Terminal Cover (3P)	3	X				S29515
	Long Terminal Cover (3P/1SC)	3		X	X	X	S35169
	Short Terminal Cover (4P)	4		X			S29516
	Long Terminal Cover (4P/1SC)	4				X	S35170
	Long Terminal Cover (4P/2SC)	4	X		X		S35178
U-Frame	Short Rear Connector (set of 2)▲	3, 4		X		X	S29235
	Long Rear Connector (set of 2)▲	3, 4		X			S29236
	Short Terminal Cover (3P)	3	X				S32562
	Extended Terminal Cover (3P/1SC)	3		X	X	X	S35171
	Short Terminal Cover (4P)	4		X			S32563
U-Frame	Extended Term Cover (4P/1SC)	4				X	S35172
	Extended Term Cover (4P/2SC)	4	X		X		S38293
	Short Rear Connector (set of 2)▲■	3, 4		X		X	S432475
	Long Rear Connector (set of 2)▲■	3, 4		X			S432476

- ▲ The ungrounded configurations (3P or 4P) need 2 short and 2 long rear connectors. The grounded configurations only use 2 short rear connectors.
- Parts only, no hardware is included. See table PV U-Frame, below.
- ◆ P: Poles, SC: Serial connector.

PV T-Frame Bus Bar and Rear Connections Hardware

Choose termination "F" for having the termination kit included with the breaker (Terminal Nuts, Term Covers, Serial Connectors)

Description	Cat. No.
T-Frame Term Nut Insert-Metric/M8 (12)	S30554

PV U-Frame Bus Bar and Rear Connections Hardware

Choose termination "F" for having the termination kit included with the breaker (Screws and Washers, Term Covers, Serial Connectors)

Description	Cat. No.
Set of 4 M10 x 25 terminal screws and washers for one side	S36967

Mechanical Lug Kits for T- and U-Frame Circuit Breakers and Switches

Frame	Description	Conductor		Current	Cat. No.	Qty. Per Kit	
		Type	No. Per Lug				
T-Frame	Lug(2) T-Frame, 12-4 AWG, Al/Cu	Al	1	#12-#4 AWG (4-25 mm ²)	50-60 A	S35167	2
		Cu	1	#14-#4 AWG (2.5-25 mm ²)			
	Lugs(2) T-Frame, 4-4/0 AWG, Al/Cu	Al	1	#4-#4/0 AWG (25-95 mm ²)	70-150 A	S29255	2
		Cu	1	#250-350 AWG (120-185 mm ²)			
U-Frame	Lug(2) U-Frame, 2/0 AWG-500 kcmil, Al/Cu	Al	2	2/0 AWG-500 kcmil (70-240 mm ²)	225-500 A	S35180	2
		Cu	2	2/0 AWG-500 kcmil (70-240 mm ²)			

NOTE: For availability dates of field installable accessories in Tables above contact Schneider Electric.

Photovoltaic Circuit Breakers and Switches T-Frame Dimensions and Shipping Weights

Class 611 / Refer to Catalog 0611CT1302

PV T-Frame Circuit Breaker and Switches Dimensions

	A2	A3	B1	B2	C2	C3
in	7.40	11.42	4.13	5.51	3.39	4.96
mm	188	290	105	140	86	126

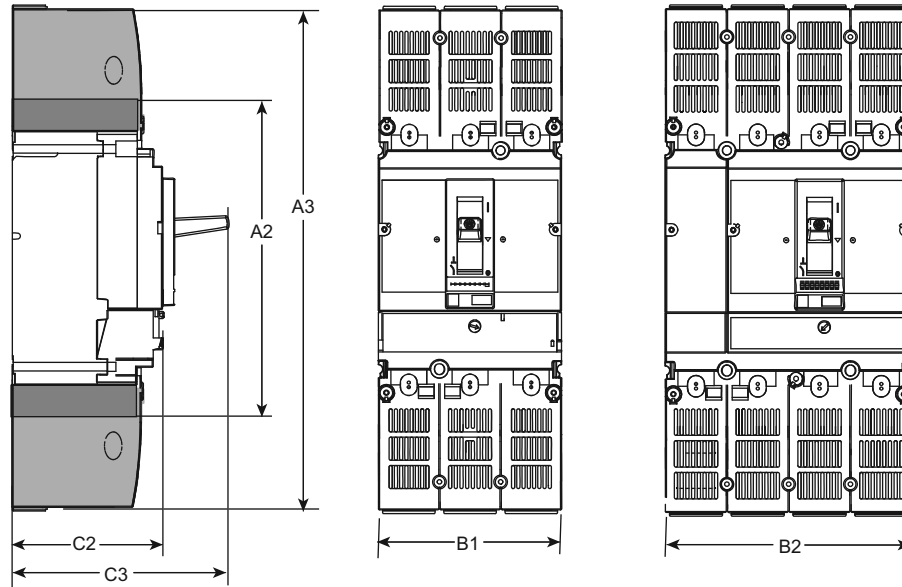

A2: Short
A3: Long

Terminal Cover Configuration According to Wiring Configuration

Wiring Configuration	Connection Type		Terminal Cover Configuration	
	Unit Mount/Bus	Rear Connected	Top	Bottom
3P Ungrounded	X		Long	Long
		X	Short	Long
3P Grounded	X	X	Long	Long
4P Ungrounded	X		Long	Long
		X	Long	Short
4P Grounded	X	X	Long	Long

Approximate Weights

T-Frames	Product Weight (lbs)	Shipping Weights (lbs)
3P Ungrounded	5	8
3P Grounded	5.5	8.5
4P Ungrounded	6.3	9.3
4P Grounded	6.7	9.7

DE3 CIRCUIT BREAKERS

DE3

Photovoltaic Circuit Breakers and Switches

U-Frame Dimensions and Shipping Weights Class 611 / Refer to Catalog 0611CT1302

PV U-Frame Circuit Breaker and Switches Dimensions

	A2	A3	A4	B1	B2	C2	C3
in	11.2	15.7	19.1	5.5	7.2	4.3	6.6
mm	285	400	484	140	183	110	168

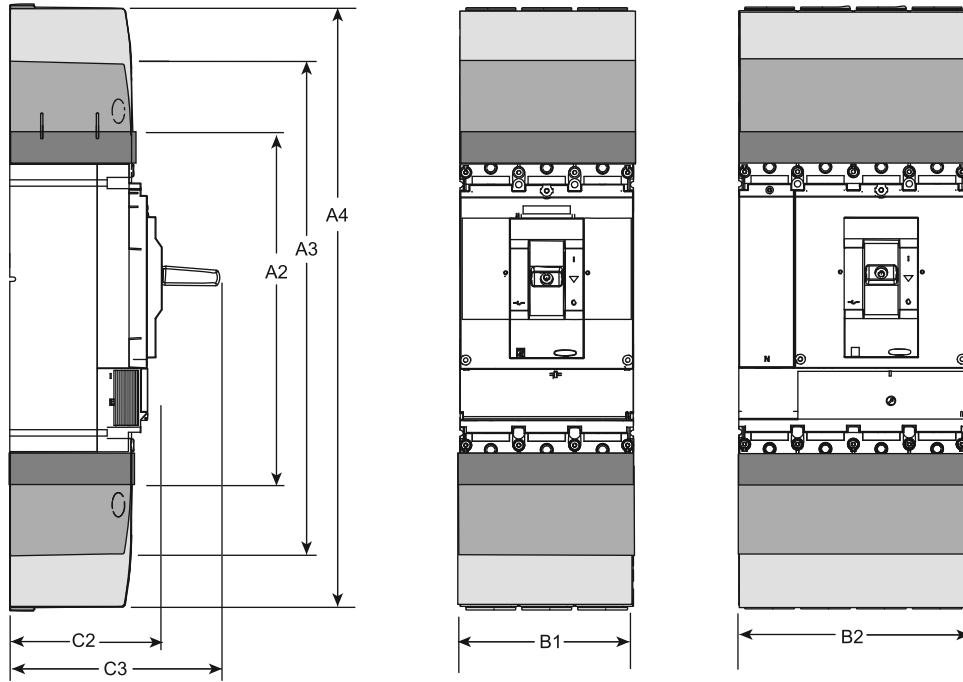

A2: Short
 A3: Long
 A4: Extended

Terminal Cover Configuration According to Wiring Configuration

Wiring Configuration	Connection Type		Terminal Cover Configuration	
	Unit Mount/Bus	Rear Connected	Top	Bottom
3P Ungrounded	X	X	Long	Extended
			Short	
3P Grounded	X	X	Extended	Long
4P Ungrounded	X	X		Short
4P Grounded	X	X		Extended

Approximate Weights

U-Frames	Product Weight (lbs)	Shipping Weights (lbs)
3P Ungrounded	15	19.5
3P Grounded	17	21.5
4P Ungrounded	21	25.5
4P Grounded	23	27.5

PV T- and U-Frame Circuit Breakers and Switches Wiring Configurations

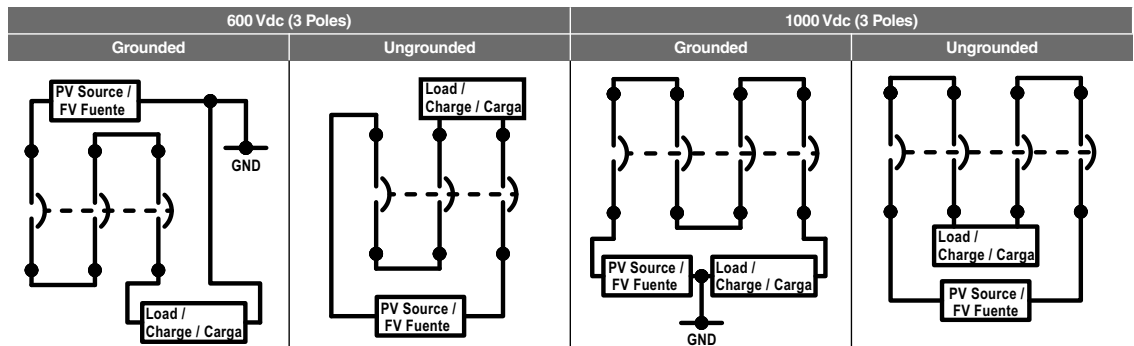

Moulded Case Circuit Breaker

F-Frame Thermal-Magnetic Circuit Breakers

Thermal-magnetic moulded case circuit breakers shown here are permanent trip CSA certified, UL listed, IEC rated. For I-LINE moulded case circuit breakers, see Section DE-5.

Ampere Rating	AC Magnetic Trip Settings Amperes	One Pole		Two Pole		Three Pole		Standard Lug Kit Wire Range
		Catalogue No.	Price	Catalogue No.	Price	Catalogue No.	Price	

100 Ampere Frame

FAL Standard Interrupting 120/240 Volt

Ampere Rating	Hold	Trip	120Vac		240Vac		240Vac		Standard Lug Kit Wire Range
			Catalogue No.	Price	Catalogue No.	Price	Catalogue No.	Price	
15	275	600	FAL12015		FAL22015		FAL32015		AL50FA #14-#4 Cu or #12-#4 Al
20	275	600	FAL12020		FAL22020		FAL32020		
25	275	600	FAL12025		FAL22025		FAL32025		
30	275	600	FAL12030		FAL22030		FAL32030		
35	400	850	FAL12035		FAL22035		FAL32035		AL100FA #14-#1/0 Cu or #12-#1/0 Al
40	400	850	FAL12040		FAL22040		FAL32040		
45	400	850	FAL12045		FAL22045		FAL32045		
50	400	850	FAL12050		FAL22050		FAL32050		
60	800	1450	FAL12060		FAL22060		FAL32060		
70	800	1450	FAL12070		FAL22070		FAL32070		
80	800	1450	FAL12080		FAL22080		FAL32080		
90	900	1700	FAL12090		FAL22090		FAL32090		
100	900	1700	FAL12100		FAL22100		FAL32100		

FAL Standard Interrupting 277/480 Volt

Ampere Rating	Hold	Trip	277Vac,125Vdc		480Vac,250Vdc		480Vac,250Vdc		Standard Lug Kit Wire Range
			Catalogue No.	Price	Catalogue No.	Price	Catalogue No.	Price	
15	275	600	FAL14015		FAL24015		FAL34015		AL50FA #14-#4 Cu or #12-#4 Al
20	275	600	FAL14020		FAL24020		FAL34020		
25	275	600	FAL14025		FAL24025		FAL34025		
30	275	600	FAL14030		FAL24030		FAL34030		
35	400	850	FAL14035		FAL24035		FAL34035		AL100FA #14-#1/0 Cu or #12-#1/0 Al
40	400	850	FAL14040		FAL24040		FAL34040		
45	400	850	FAL14045		FAL24045		FAL34045		
50	400	850	FAL14050		FAL24050		FAL34050		
60	800	1450	FAL14060		FAL24060		FAL34060		
70	800	1450	FAL14070		FAL24070		FAL34070		
80	800	1450	FAL14080		FAL24080		FAL34080		
90	900	1700	FAL14090		FAL24090		FAL34090		
100	900	1700	FAL14100		FAL24100		FAL34100		

FAL Standard Interrupting 347/600 Volt

Ampere Rating	Hold	Trip	347Vac,125Vdc		600Vac,250Vdc		600Vac,250Vdc		Standard Lug Kit Wire Range
			Catalogue No.	Price	Catalogue No.	Price	Catalogue No.	Price	
15	275	600	FAL17015		FAL26015		FAL36015		AL50FA #14-#4 Cu or #12-#4 Al
20	275	600	FAL17020		FAL26020		FAL36020		
25	275	600	FAL17025		FAL26025		FAL36025		
30	275	600	FAL17030		FAL26030		FAL36030		
35	400	850	FAL17035		FAL26035		FAL36035		AL100FA #14-#1/0 Cu or #12-#1/0 Al
40	400	850	FAL17040		FAL26040		FAL36040		
45	400	850	FAL17045		FAL26045		FAL36045		
50	400	850	FAL17050		FAL26050		FAL36050		
60	800	1450	FAL17060		FAL26060		FAL36060		
70	800	1450	FAL17070		FAL26070		FAL36070		
80	800	1450	FAL17080		FAL26080		FAL36080		
90	900	1700	FAL17090		FAL26090		FAL36090		
100	900	1700	FAL17100		FAL26100		FAL36100		

FHL High Interrupting 347/600 Volt

Ampere Rating	Hold	Trip	347Vac,125Vdc		600Vac,250Vdc		600Vac,250Vdc		Standard Lug Kit Wire Range
			Catalogue No.	Price	Catalogue No.	Price	Catalogue No.	Price	
15	275	600	FHL17015		FHL26015		FHL36015		AL50FA #14-#4 Cu or #12-#4 Al
20	275	600	FHL17020		FHL26020		FHL36020		
25	275	600	FHL17025		FHL26025		FHL36025		
30	275	600	FHL17030		FHL26030		FHL36030		
35	400	850	FHL17035		FHL26035		FHL36035		AL100FA #14-#1/0 Cu or #12-#1/0 Al
40	400	850	FHL17040		FHL26040		FHL36040		
45	400	850	FHL17045		FHL26045		FHL36045		
50	400	850	FHL17050		FHL26050		FHL36050		
60	800	1450	FHL17060		FHL26060		FHL36060		
70	800	1450	FHL17070		FHL26070		FHL36070		
80	800	1450	FHL17080		FHL26080		FHL36080		
90	900	1700	FHL17090		FHL26090		FHL36090		
100	900	1700	FHL17100		FHL26100		FHL36100		



FAL/FHL
One Pole
15-100 Ampere



FAF/FHL
Two Pole
15-100Ampere



FAL/FHL
Three Pole
15-100Ampere

CSA Certified Interrupting Rating RMS Symmetrical Amperes

Breaker Catalogue No. Prefix	System Voltage				
	120/240	277/480	347/600	125	250
FAL (240V.) 1-Pole	10k			5k	
2, 3-Pole	10k			5k	5k
FAL (480V.) 1-Pole	18k	18k		10k	
2, 3-Pole	25k	18k		10k	10k
FAL (600V.) 1-Pole	25k	18k	14k	10k	
2, 3-Pole	25k	18k	14k	10k	10k
FHL 1-Pole					
15-30	65k	65k	18k	10k	
35-100	65k	25k	18k	10k	
2, 3-Pole	65k	25k	18k	50k	50k

DE3 CIRCUIT BREAKERS

Dimensions-DE3-54
Enclosures -DE3-56

Moulded Case Circuit Breakers

Q4L - LAL - LHL

CSA Certified Interrupting Rating

RMS Symmetrical Amperes

Breaker Cat. No. Prefix	System Voltage AC			DC	
	240	480	600	125	250
Q4L	25k				
LAL	42k	30k	22k	10k	10k
LHL	65k	35k	25k	50k	50k

Enclosures - DE3-56

Dimensions - DE3-54

Ampere Rating	AC Magnetic Trip Settings Amperes	Two Pole		Three Pole		Standard Lug Kit Wire Range
		Catalogue No.	Price	Catalogue No.	Price	

400 Ampere Frame

Q4L Standard Interrupting

Ampere Rating	Low	High	240Vac		240Vac		Standard Lug Kit Wire Range
			Cat. No.	Price	Cat. No.	Price	
250	1250	2500	Q4L2250		Q4L3250		AL400LA
300	1500	3000	Q4L2300		Q4L3300		1-#1-600 kcmil or
350	1750	3500	Q4L2350		Q4L3350		2-#1-250 kcmil
400	2000	4000	Q4L2400		Q4L3400		AL400LA

LAL Standard Interrupting

Ampere Rating	Low	High	600Vac, 250Vdc		600Vac, 250Vdc		Standard Lug Kit Wire Range
			Cat. No.	Price	Cat. No.	Price	
125	625	1250	LAL26125		LAL36125		AL400LA 1-#1-600 kcmil or 2-#1-250 kcmil
150	750	1500	LAL26150		LAL36150		
175	875	1750	LAL26175		LAL36175		
200	1000	2000	LAL26200		LAL36200		
225	1125	2250	LAL26225		LAL36225		
250	1250	2500	LAL26250		LAL36250		
300	1500	3000	LAL26300		LAL36300		
350	1750	3500	LAL26350		LAL36350		
400	2000	4000	LAL26400		LAL36400		

LHL High Interrupting

Ampere Rating	Low	High	600Vac, 250Vdc		600Vac, 250Vdc		Standard Lug Kit Wire Range
			Cat. No.	Price	Cat. No.	Price	
125	625	1250	LHL26125		LHL36125		AL400LA 1-#1-600 kcmil or 2-#1-250 kcmil
150	750	1500	LHL26150		LHL36150		
175	875	1750	LHL26175		LHL36175		
200	1000	2000	LHL26200		LHL36200		
225	1125	2250	LHL26225		LHL36225		
250	1250	2500	LHL26250		LHL36250		
300	1500	3000	LHL26300		LHL36300		
350	1750	3500	LHL26350		LHL36350		
400	2000	4000	LHL26400		LHL36400		



LAL/LHL
Two and Three Pole
125-400 Amperes

DE3 CIRCUIT BREAKERS

Moulded Case Circuit Breakers

CDP Breaker Cross to Square D

CDP Connector Kits

The CDP connector kits are used to install Square D breakers into existing Federal Pioneer CDP panels and Switchboard distribution interiors that originally used branch breakers from the Horizon family.

Please note that these connector kits are designed to be applied on CDP interiors with Extruded Bus only, (except HDCMH, JDCMH, and LDCMH that can be also used on CDP interiors with Flat Bus).

Please refer to installation bulletins for detailed information on these kits.

Retrofitting or adding new Square D Breakers into CDP Interiors

Federal Pioneer Horizon Breaker	Amperage	Alternate Square D Breaker	Connector Mounting Hardware
CE Breaker	15A – 100A	15A – 100A Powerpact H ■	HDCMH
	150A – 250A	150A – 225A Powerpact J ■	JDCMH
CJL Breaker	100A – 400A	LA/LH ●	LACMH
CJM Breaker*	300A – 600A	400A-600A PowerPact L ● □	LDCMH
CK	250A – 1200A	Powerpact P ◆	PCDPCMH

- Need to be replaced in pairs, can not mount a CE breaker back to back with a PowerPact breaker. Not suitable for 100% rated and type HR, JR MCCBs.
- Available only as single mount option. Not available as a double mount or Back to back mount due to dimensional constraints.
 - Condition 1: Panel with all single row branch circuits.*
A minimum branch circuit height of 8-1/4" is required.
 - Condition 2: Panel with all double row branch circuits.*
This will require a modification to the trim to remove a section of the trim centre strip in the location where the new breaker is to be installed. A minimum branch circuit height of 9-5/8" is required and the breaker should be located where the centre strip ends. (This space includes one 1 -3/8" wide filler to support the center strip).
If the breaker must be located between two sections of a double row trim then the minimum branch circuit height required is 11". (This space includes two 1-3/8" wide fillers to support both ends of the centre strips)
- The PowerPact L-Frame breaker has an overall height of 5-1/2" but will be fitted with a Cover plate to fill the existing branch circuit space of 8-1/4".
- ◆ Available only for single mount. The CK breaker can not be replaced in existing 12X of branch circuit height, the Square D PowerPact breaker requires space with a 16X branch nominal height. Contact Schneider Services for installation of PowerPact P breaker and mounting hardware.
- * PowerPact L-Frame can also be used to replace Square D LC/LI/LX/LE/LXI installed in CDP panels as a replacement of CJM breakers.