

## High Speed Optocoupler, Dual, 5 MBd, in SOIC-8 Package

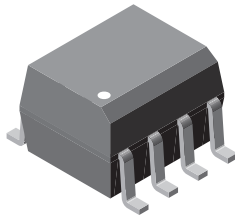

i179074

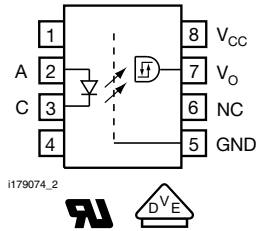

i179074\_2



### FEATURES

- Data rate 5 Mbits/s (2.5 Mbit/s over temperature)
- Buffer
- Isolation test voltage, 4000 V<sub>RMS</sub>
- TTL, LSTTL and CMOS compatible
- Internal shield for very high common mode transient immunity
- Wide supply voltage range (4.5 V to 15 V)
- Low input current (1.6 mA to 5 mA)
- Parameters specified from 0 °C to 85 °C
- T<sub>amb</sub> from - 40 °C to 100 °C
- Compliant to RoHS Directive to 2002/95/EC and in accordance WEEE 2002/96/EC



**RoHS**  
COMPLIANT

### DESCRIPTION

The single channel 5 Mb/s SFH6720T and SFH6721T high speed optocoupler consists of a GaAlAs infrared emitting diode, optically coupled with an integrated photo detector. The detector incorporates a schmitt-trigger stage for improved noise immunity. A faraday shield provides a common mode transient immunity of 1000 V/μs at V<sub>CM</sub> = 50 V for SFH6720T and 2500 V/μs at V<sub>CM</sub> = 400 V for SFH6721T.

The SFH6720T and SFH6721T uses an industry standard SOIC-8A package.

### AGENCY APPROVALS

- UL1577, file no. E52744 system code Y
- DIN EN 60747-5-5 (VDE 0884) available with option 1

### APPLICATIONS

- Industrial control
- Replace pulse transformers
- Routine logic interfacing
- Motion/power control
- High speed line receiver
- Microprocessor system interfaces
- Computer peripheral interfaces

### ORDERING INFORMATION

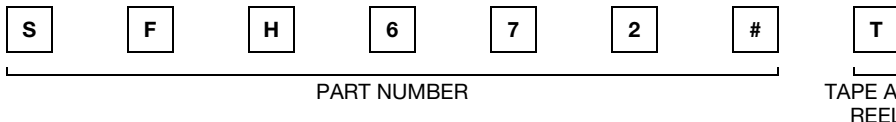

| AGENCY CERTIFIED/PACKAGE | CMR (kV/μs)   | CMR (kV/μs) |
|--------------------------|---------------|-------------|
| <b>UL</b>                | <b>1</b>      | <b>2.5</b>  |
| SOIC-8                   | SFH6720T      | SFH6721T    |
| <b>VDE, UL</b>           | <b>1</b>      | <b>2.5</b>  |
| SOIC-8                   | SFH6720-X001T | -           |

### TRUTH TABLE (positive logic)

| PART     | IR DIODE | OUTPUT |
|----------|----------|--------|
| SFH6720T | On       | H      |
|          | Off      | L      |
| SFH6721T | On       | H      |
|          | Off      | L      |

# SFH6720T, SFH6721T



Vishay Semiconductors High Speed Optocoupler, Dual,  
5 MBd, in SOIC-8 Package

| ABSOLUTE MAXIMUM RATINGS <sup>(1)</sup> ( $T_{amb} = 25\text{ }^{\circ}\text{C}$ , unless otherwise specified) |   |            |               |                    |
|--|---|------------|---------------|--------------------|
| PARAMETER  | TEST CONDITION  | SYMBOL     | VALUE         | UNIT               |
| <b>INPUT</b>   |   |            |               |                    |
| Reverse voltage  |   | $V_R$      | 3             | V                  |
| DC forward current   |   | $I_F$      | 10            | mA                 |
| Surge forward  | $t_p \leq 1\text{ }\mu\text{s}$ , 300 pulses/s                    | $I_{FSM}$  | 1             | mA                 |
| Power dissipation  |   | $P_{diss}$ | 20            | mW                 |
| <b>OUTPUT</b>  |   |            |               |                    |
| Supply voltage   |   | $V_{CC}$   | - 0.5 to + 15 | V                  |
| Output voltage   |   | $V_O$      | - 0.5 to + 15 | V                  |
| Average output current   |   | $I_O$      | 25            | mA                 |
| Power dissipation  |   | $P_{diss}$ | 100           | mW                 |
| <b>COUPLER</b>   |   |            |               |                    |
| Storage temperature range  |   | $T_{stg}$  | - 55 to + 125 | $^{\circ}\text{C}$ |
| Ambient temperature range  |   | $T_{amb}$  | + 85          | $^{\circ}\text{C}$ |
| Isolation test voltage   | $t = 1\text{ s}$  | $V_{ISO}$  | 4000          | $V_{RMS}$          |
| Pollution degree   |   |            | 2             |                    |
| Creepage distance  |   |            | 4             | mm                 |
| Clearance distance   |   |            | 4             | mm                 |
| Comparative tracking index per DIN IEC112/VDE 0303, part 1   |   | CTI        | 175           |                    |
| Isolation resistance   | $V_{IO} = 500\text{ V}$ , $T_{amb} = 25\text{ }^{\circ}\text{C}$  | $R_{IO}$   | $10^{12}$     | $\Omega$           |
|  | $V_{IO} = 500\text{ V}$ , $T_{amb} = 100\text{ }^{\circ}\text{C}$ | $R_{IO}$   | $10^{11}$     | $\Omega$           |
| Lead soldering temperature <sup>(2)</sup>  | $t = 10\text{ s}$   | $T_{sld}$  | 260           | $^{\circ}\text{C}$ |

## Notes

- (1) Stresses in excess of the absolute maximum ratings can cause permanent damage to the device. Functional operation of the device is not implied at these or any other conditions in excess of those given in the operational sections of this document. Exposure to absolute maximum ratings for extended periods of the time can adversely affect reliability.
- (2) Refer to reflow profile soldering conditions for surface mounted devices.

| RECOMMENDED OPERATING CONDITIONS <sup>(1)</sup> |                |            |                    |      |      |                    |
|---|----------------|------------|--------------------|------|------|--------------------|
| PARAMETER                                       | TEST CONDITION | SYMBOL     | MIN.               | TYP. | MAX. | UNIT               |
| Supply voltage                                  |                | $V_{CC}$   | 4.5                |      | 15   | V                  |
| Forward input current                           |                | $I_{Fon}$  | 1.6 <sup>(2)</sup> |      | 5    | mA                 |
|   |                | $I_{Foff}$ |                    |      | 0.1  | mA                 |
| Operating temperature                           |                | $T_A$      | - 40               |      | 85   | $^{\circ}\text{C}$ |

## Notes

- (1) A 0.1  $\mu\text{F}$  bypass capacitor connected between pins 5 and 8 must be used.
- (2) We recommended using a 2.2 mA if to permit at least 20 % CTR degradation guard band.

| ELECTRICAL CHARACTERISTICS <sup>(1)</sup> |  |            |      |      |      |               |
|---|--|------------|------|------|------|---------------|
| PARAMETER                                 | TEST CONDITION   | SYMBOL     | MIN. | TYP. | MAX. | UNIT          |
| <b>INPUT</b>                              |  |            |      |      |      |               |
| Forward voltage                           | $I_F = 5\text{ mA}$ , $25\text{ }^{\circ}\text{C}$     | $V_F$      |      | 1.6  | 1.75 | V             |
|   |  | $V_F$      |      |      | 1.9  | V             |
| Input current hysteresis                  | $V_{CC} = 5\text{ V}$ , $I_{HYS} = I_{Fon} - I_{Foff}$ | $I_{HYS}$  | 0.1  |      |      | V             |
| Reverse current                           | $V_R = 3\text{ V}$                                     | $I_R$      |      | 0.5  | 10   | $\mu\text{A}$ |
| Capacitance                               | $V_R = 0\text{ V}$ , $f = 1\text{ MHz}$                | $C_O$      |      | 60   |      | pF            |
| Thermal resistance                        |  | $R_{thja}$ |      | 700  |      | K/W           |

| <b>ELECTRICAL CHARACTERISTICS (1)</b>   |  |            |           |      |      |               |
|---|--|------------|-----------|------|------|---------------|
| PARAMETER   | TEST CONDITION   | SYMBOL     | MIN.      | TYP. | MAX. | UNIT          |
| <b>OUTPUT</b>   |  |            |           |      |      |               |
| Logic low output voltage  | $I_{OL} = 6.4 \text{ mA}$  | $V_{OL}$   |           |      | 0.5  | V             |
| Logic high output voltage   | $I_{OH} = -2.6 \text{ mA}$ ,<br>$V_{OH} = V_{CC} - 1.8 \text{ V}$          | $V_{OH}$   | 2.4       |      |      | V             |
| Output leakage current<br>( $V_{OUT} > V_{CC}$ )  | $V_O = 5.5 \text{ V}$ , $V_{CC} = 4.5 \text{ V}$ ,<br>$I_F = 5 \text{ mA}$ | $I_{OHH}$  |           | 0.5  | 100  | $\mu\text{A}$ |
|   | $V_O = 15 \text{ V}$ , $V_{CC} = 4.5 \text{ V}$ ,<br>$I_F = 5 \text{ mA}$  | $I_{OHH}$  |           | 1    | 500  | $\mu\text{A}$ |
| Logic low supply current  | $V_{CC} = 5.5 \text{ V}$ , $I_F = 0$                                       | $I_{CCL}$  |           | 3.7  | 6    | mA            |
|   | $V_{CC} = 15 \text{ V}$ , $I_F = 0$  | $I_{CCL}$  |           | 4.1  | 6.5  | mA            |
| Logic high supply current   | $V_{CC} = 5.5 \text{ V}$ , $I_F = 5 \text{ mA}$                            | $I_{CCH}$  |           | 3.4  | 4    | mA            |
|   | $V_{CC} = 15 \text{ V}$ , $I_F = 5 \text{ mA}$                             | $I_{CCH}$  |           | 3.7  | 5    | mA            |
| Logic low short circuit output<br>current<br>(output short circuit time $\leq 10 \text{ ms}$ )  | $V_O = V_{CC} = 5.5 \text{ V}$ , $I_F = 0$                                 | $I_{OSL}$  | 25        |      |      | mA            |
|   | $V_O = V_{CC} = 15 \text{ V}$ , $I_F = 0$                                  | $I_{OSL}$  | 40        |      |      | mA            |
| Logic high short circuit output<br>current<br>(output short circuit time $\leq 10 \text{ ms}$ ) | $V_{CC} = 5.5 \text{ V}$ , $V_O = 0 \text{ V}$ ,<br>$I_F = 5 \text{ mA}$   | $I_{OSH}$  |           |      | -10  | mA            |
|   | $V_{CC} = 15 \text{ V}$ , $V_O = 0 \text{ V}$ , $I_F = 5 \text{ mA}$       | $I_{OSH}$  |           |      | -25  | mA            |
| Thermal resistance  |  | $R_{thja}$ |           | 300  |      | K/W           |
| <b>COUPLER</b>  |  |            |           |      |      |               |
| Capacitance (input to output)   | $f = 1 \text{ MHz}$ , pins 1 to 4 and 5 to 8<br>shorted together           | $C_{IO}$   |           | 0.6  |      | pF            |
| Isolation resistance  | $V_{IO} = 500 \text{ V}$ , $T_{amb} = 25 \text{ }^\circ\text{C}$           |            | $10^{12}$ |      |      | $\Omega$      |
|   | $V_{IO} = 500 \text{ V}$ , $T_{amb} = 100 \text{ }^\circ\text{C}$          |            | $10^{11}$ |      |      | $\Omega$      |

**Note**

(1)  $-40 \text{ }^\circ\text{C} \leq T_{amb} \leq 85 \text{ }^\circ\text{C}$ ;  $4.5 \text{ V} \leq V_{CC} \leq 15 \text{ V}$ ;  $1.6 \text{ mA} \leq I_{Fon} \leq 5 \text{ mA}$ ;  $2 \leq V_{EH} \leq 15 \text{ V}$ ;  $0 \leq V_{EL} \leq 0.8 \text{ V}$ ;  $0 \text{ mA} \leq I_{Foff} \leq 0.1 \text{ mA}$ .

Typical values:  $T_{amb} = 25 \text{ }^\circ\text{C}$ ;  $V_{CC} = 5 \text{ V}$ ;  $I_{Fon} = 3 \text{ mA}$  unless otherwise specified.

Minimum and maximum values are testing requirements. Typical values are characteristics of the device and are the result of engineering evaluation. Typical values are for information only and are not part of the testing requirements.

| <b>SWITCHING CHARACTERISTICS (1)</b>                 |                           |           |      |      |      |      |
|--|---------------------------|-----------|------|------|------|------|
| PARAMETER  | TEST CONDITION            | SYMBOL    | MIN. | TYP. | MAX. | UNIT |
| Propagation delay time to logic<br>low output level  | Without peaking capacitor | $t_{PHL}$ |      | 120  |      | ns   |
|  | With peaking capacitor    | $t_{PHL}$ |      | 115  | 300  | ns   |
| Propagation delay time to logic<br>high output level | Without peaking capacitor | $t_{PLH}$ |      | 125  |      | ns   |
|  | With peaking capacitor    | $t_{PLH}$ |      | 90   | 300  | ns   |
| Output rise time                                     | 10 % to 90 %              | $t_r$     |      | 40   |      | ns   |
| Output fall time                                     | 90 % to 10 %              | $t_f$     |      | 10   |      | ns   |

**Note**

(1)  $0 \text{ }^\circ\text{C} \leq T_{amb} \leq 85 \text{ }^\circ\text{C}$ ;  $4.5 \text{ V} \leq V_{CC} \leq 15 \text{ V}$ ;  $1.6 \text{ mA} \leq I_{Fon} \leq 5 \text{ mA}$ ;  $0 \text{ mA} \leq I_{Foff} \leq 0.1 \text{ mA}$

Typical values:  $T_{amb} = 25 \text{ }^\circ\text{C}$ ;  $V_{CC} = 5 \text{ V}$ ;  $I_{Fon} = 3 \text{ mA}$  unless otherwise specified. A  $0.1 \mu\text{F}$  bypass capacitor connected between pins 5 and 8 must be used.

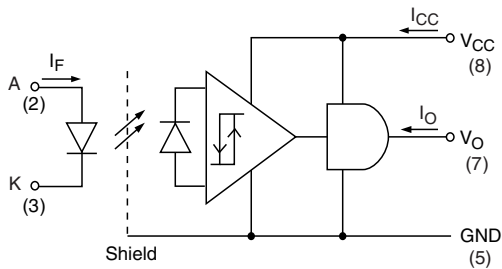

isfh6720\_00

| COMMON MODE TRANSIENT IMMUNITY (1)            |  |          |          |        |      |      |                  |
|---|--|----------|----------|--------|------|------|------------------|
| PARAMETER                                     | TEST CONDITION                                   | PART     | SYMBOL   | MIN.   | TYP. | MAX. | UNIT             |
| Logic high common mode transient immunity (2) | $ V_{CM}  = 50 \text{ V}, I_F = 1.6 \text{ mA}$  | SFH6720T | $ CM_H $ | 1000   |      |      | V/ $\mu\text{s}$ |
|   | $ V_{CM}  = 300 \text{ V}, I_F = 1.6 \text{ mA}$ | SFH6721T | $ CM_H $ | 5000   |      |      | V/ $\mu\text{s}$ |
| Logic low common mode transient immunity (2)  | $ V_{CM}  = 50 \text{ V}, I_F = 0 \text{ mA}$    | SFH6720T | $ CM_L $ | 1000   |      |      | V/ $\mu\text{s}$ |
|   | $ V_{CM}  = 1000 \text{ V}, I_F = 0 \text{ mA}$  | SFH6721T | $ CM_L $ | 10 000 |      |      | V/ $\mu\text{s}$ |

**Note**

(1)  $T_{amb} = 25 \text{ }^\circ\text{C}$ ,  $V_{CC} = 5 \text{ V}$ . (2)

(2)  $CM_H$  is the maximum slew rate of a common mode voltage  $V_{CM}$  at which the output voltage remains at logic high level ( $V_O > 2 \text{ V}$ ).  $CM_L$  is the maximum slew rate of a common mode voltage  $V_{CM}$  at which the output voltage remains at logic low level ( $V_O < 0.8 \text{ V}$ ).

| SAFETY AND INSULATION RATINGS                        |                |        |      |           |      |                  |
|--|----------------|--------|------|-----------|------|------------------|
| PARAMETER  | TEST CONDITION | SYMBOL | MIN. | TYP.      | MAX. | UNIT             |
| Climatic Classification (according to IEC 68 part 1) |                |        |      | 55/100/21 |      |                  |
| Comparative Tracking Index                           |                | CTI    | 175  |           | 399  |                  |
| $V_{IOTM}$   |                |        | 6000 |           |      | V                |
| $V_{IORM}$   |                |        | 560  |           |      | V                |
| $P_{SO}$   |                |        |      |           | 350  | mW               |
| $I_{SI}$   |                |        |      |           | 150  | mA               |
| $T_{SI}$   |                |        |      |           | 165  | $^\circ\text{C}$ |
| Creepage distance                                    |                |        | 4    |           |      | mm               |
| Clearance distance                                   |                |        | 4    |           |      | mm               |
| Insulation thickness                                 |                |        | 0.2  |           |      | mm               |

**Note**

- As per IEC 60747-5-5, § 7.4.3.8.1, this optocoupler is suitable for “safe electrical insulation” only within the safety ratings. Compliance with the safety ratings shall be ensured by means of protective circuits.

**TYPICAL CHARACTERISTICS** ( $T_{amb} = 25 \text{ }^\circ\text{C}$ , unless otherwise specified)

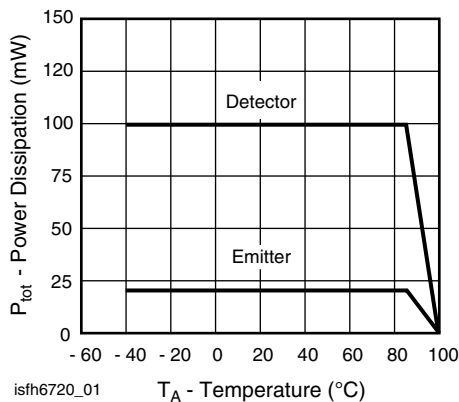

Fig. 1 - Permissible Total Power Dissipation vs. Temperature

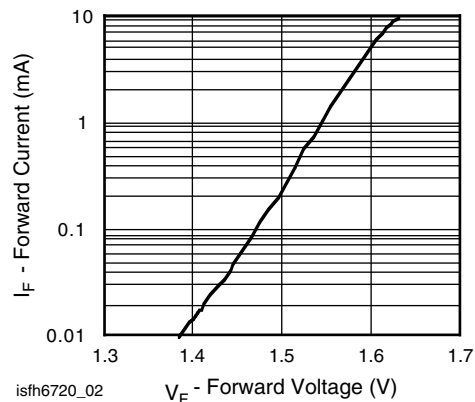

Fig. 2 - Typical Input Diode Forward Current vs. Forward Voltage

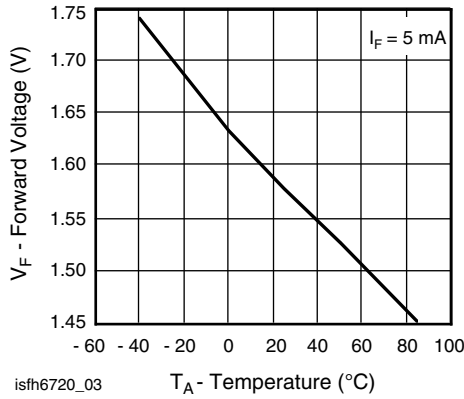

Fig. 3 - Typical Forward Input Voltage vs. Temperature

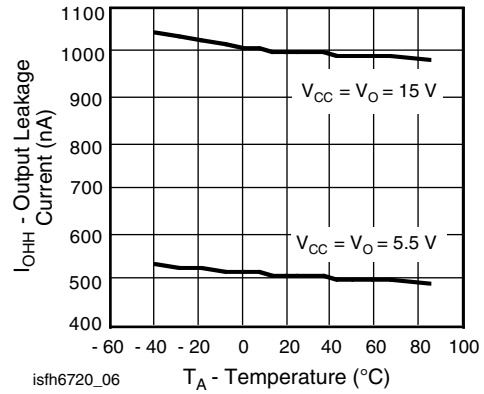

Fig. 6 - Typical Output Leakage Current vs. Temperature

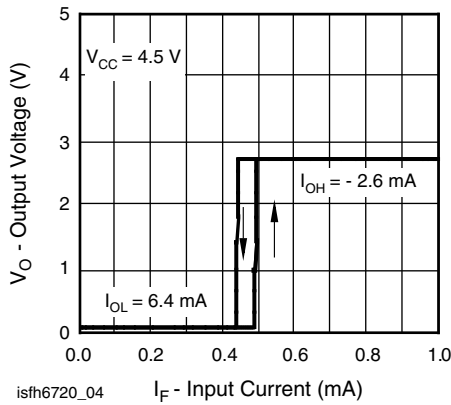

Fig. 4 - Typical Output Voltage vs. Forward Input Current

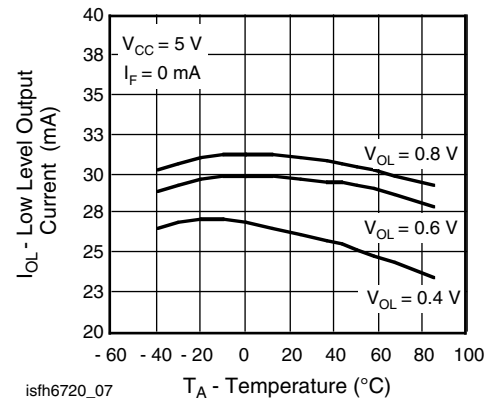

Fig. 7 - Typical Low Level Output Current vs. Temperature

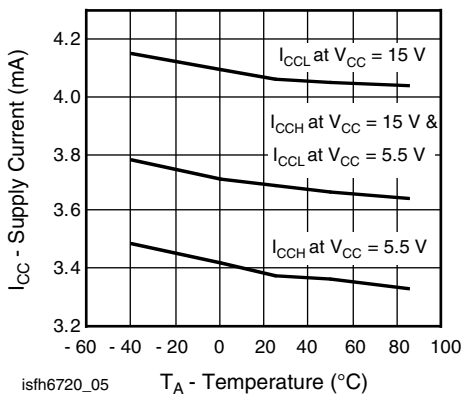

Fig. 5 - Typical Supply Current vs. Temperature

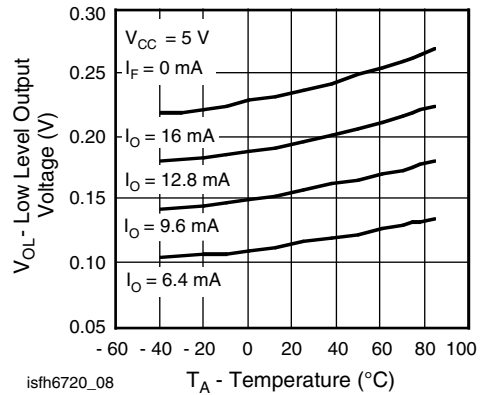

Fig. 8 - Typical Low Level Output Voltage vs. Temperature

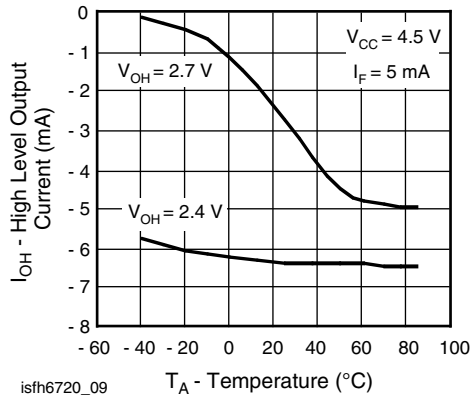

Fig. 9 - Typical High Level Output Current vs. Temperature

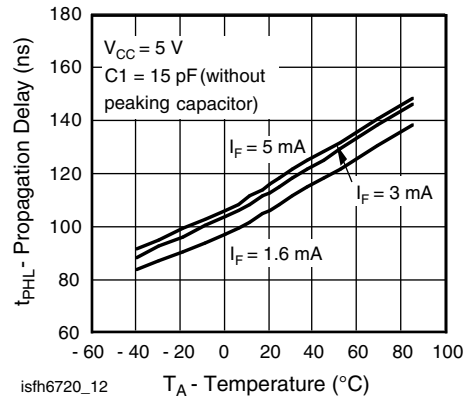

Fig. 12 - Typical Propagation Delays to Logic Low vs. Temperature

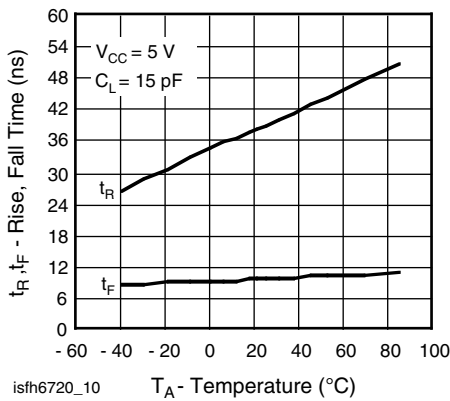

Fig. 10 - Rise and Fall Time vs. Ambient Temperature

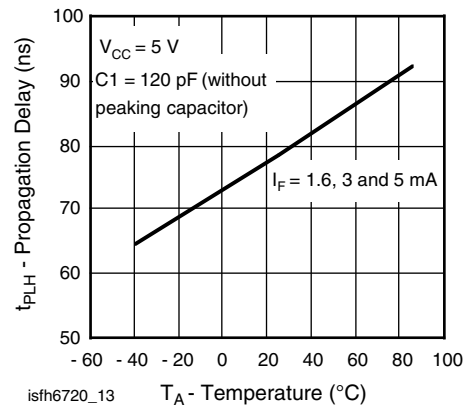

Fig. 13 - Typical Propagation Delays to Logic High vs. Temperature

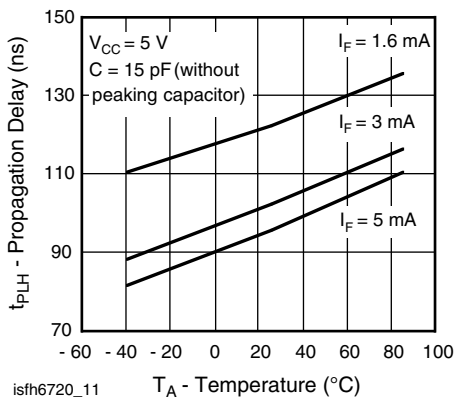

Fig. 11 - Typical Propagation Delays to Logic High vs. Temperature

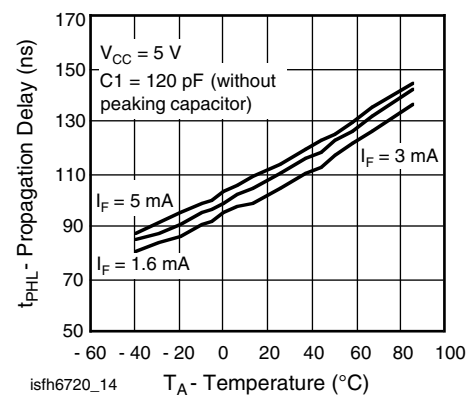

Fig. 14 - Typical Propagation Delays to Logic Low vs. Temperature

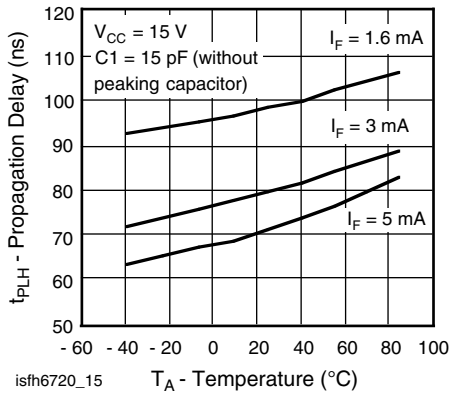

Fig. 15 - Typical Propagation Delays to Logic High vs. Temperature

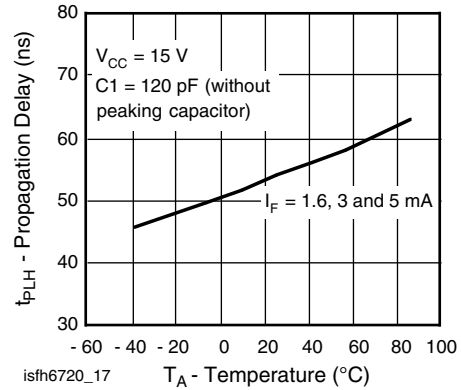

Fig. 17 - Typical Propagation Delays to Logic High vs. Temperature

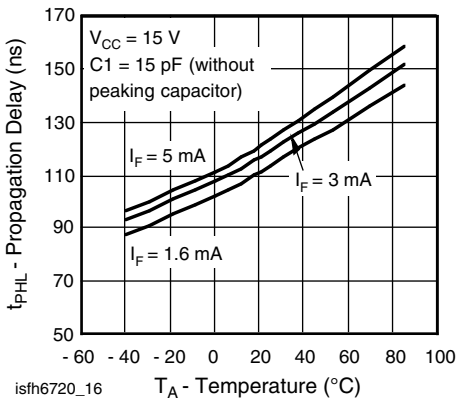

Fig. 16 - Typical Propagation Delays to Logic Low vs. Temperature

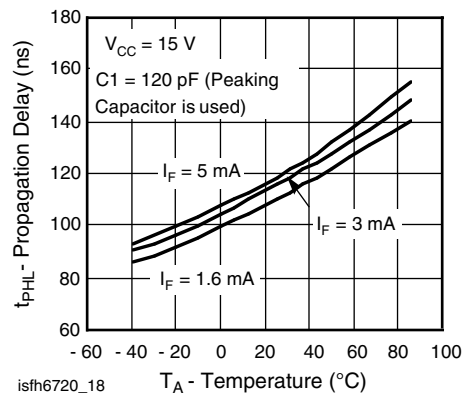

Fig. 18 - Typical Propagation Delays to Logic Low vs. Temperature

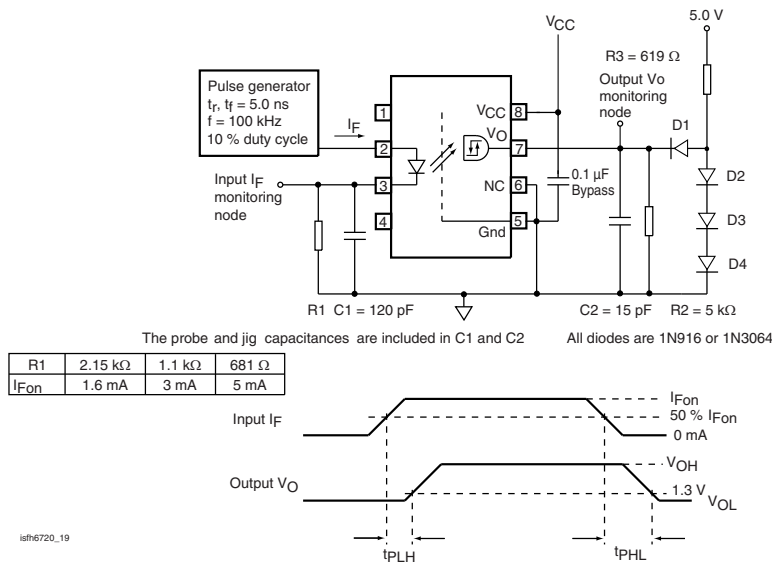

Fig. 19 - Test Circuit for  $t_{PLH}$ ,  $t_{PHL}$ ,  $t_R$  and  $t_f$

# SFH6720T, SFH6721T

Vishay Semiconductors

High Speed Optocoupler, Dual,  
5 MBd, in SOIC-8 Package

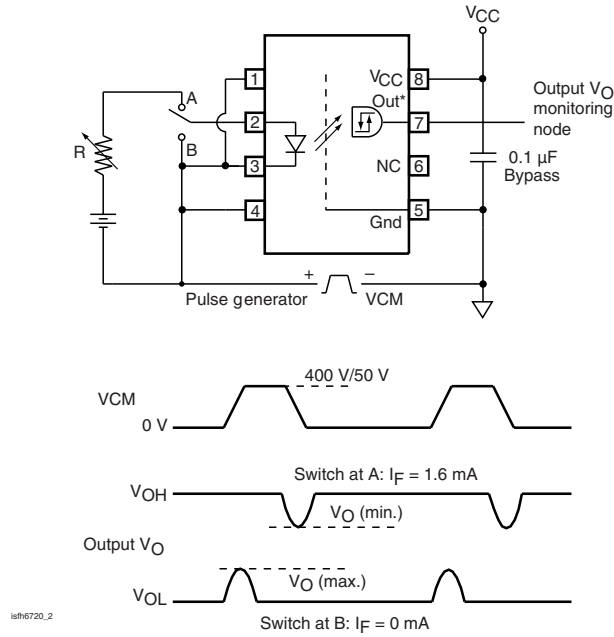
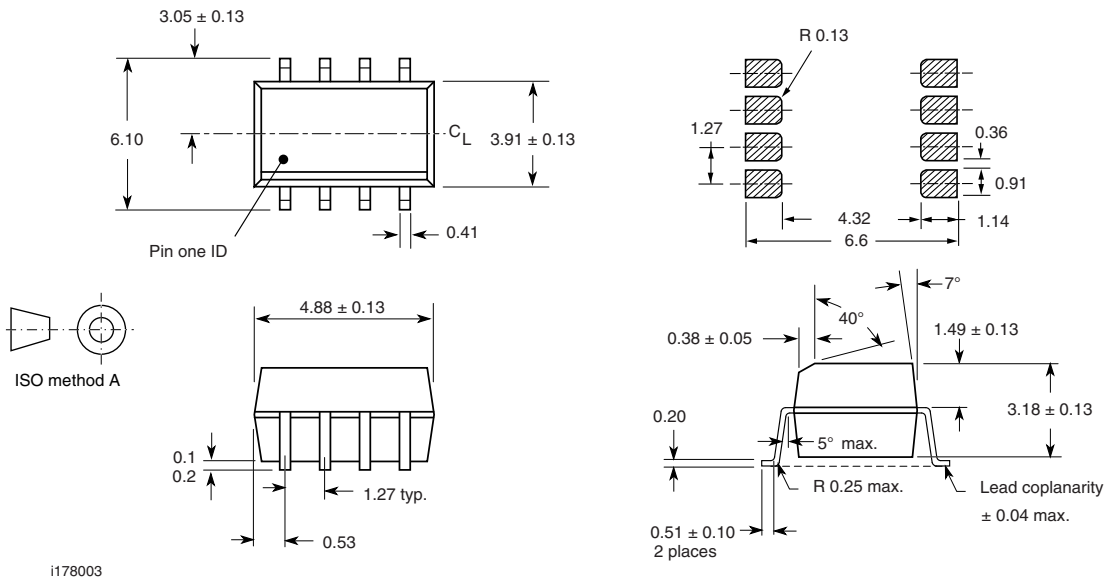

Fig. 20 - Test Circuit for Common Mode Transient Immunity and Typical Waveforms

## PACKAGE DIMENSIONS millimeters







## Disclaimer

ALL PRODUCT, PRODUCT SPECIFICATIONS AND DATA ARE SUBJECT TO CHANGE WITHOUT NOTICE TO IMPROVE RELIABILITY, FUNCTION OR DESIGN OR OTHERWISE.

Vishay Intertechnology, Inc., its affiliates, agents, and employees, and all persons acting on its or their behalf (collectively, "Vishay"), disclaim any and all liability for any errors, inaccuracies or incompleteness contained in any datasheet or in any other disclosure relating to any product.

Vishay makes no warranty, representation or guarantee regarding the suitability of the products for any particular purpose or the continuing production of any product. To the maximum extent permitted by applicable law, Vishay disclaims (i) any and all liability arising out of the application or use of any product, (ii) any and all liability, including without limitation special, consequential or incidental damages, and (iii) any and all implied warranties, including warranties of fitness for particular purpose, non-infringement and merchantability.

Statements regarding the suitability of products for certain types of applications are based on Vishay's knowledge of typical requirements that are often placed on Vishay products in generic applications. Such statements are not binding statements about the suitability of products for a particular application. It is the customer's responsibility to validate that a particular product with the properties described in the product specification is suitable for use in a particular application. Parameters provided in datasheets and/or specifications may vary in different applications and performance may vary over time. All operating parameters, including typical parameters, must be validated for each customer application by the customer's technical experts. Product specifications do not expand or otherwise modify Vishay's terms and conditions of purchase, including but not limited to the warranty expressed therein.

Except as expressly indicated in writing, Vishay products are not designed for use in medical, life-saving, or life-sustaining applications or for any other application in which the failure of the Vishay product could result in personal injury or death. Customers using or selling Vishay products not expressly indicated for use in such applications do so at their own risk. Please contact authorized Vishay personnel to obtain written terms and conditions regarding products designed for such applications.

No license, express or implied, by estoppel or otherwise, to any intellectual property rights is granted by this document or by any conduct of Vishay. Product names and markings noted herein may be trademarks of their respective owners.

## Material Category Policy

**Vishay Intertechnology, Inc. hereby certifies that all its products that are identified as RoHS-Compliant fulfill the definitions and restrictions defined under Directive 2011/65/EU of The European Parliament and of the Council of June 8, 2011 on the restriction of the use of certain hazardous substances in electrical and electronic equipment (EEE) - recast, unless otherwise specified as non-compliant.**

**Please note that some Vishay documentation may still make reference to RoHS Directive 2002/95/EC. We confirm that all the products identified as being compliant to Directive 2002/95/EC conform to Directive 2011/65/EU.**

**Vishay Intertechnology, Inc. hereby certifies that all its products that are identified as Halogen-Free follow Halogen-Free requirements as per JEDEC JS709A standards. Please note that some Vishay documentation may still make reference to the IEC 61249-2-21 definition. We confirm that all the products identified as being compliant to IEC 61249-2-21 conform to JEDEC JS709A standards.**