

G3VM-41PR12

MOS FET Relays

Smallest Class in market, USOP Package MOS FET Relays with Low Output Capacitance and ON Resistance (CxR=5pF·Ω)

• Dielectric strength of 500Vrms between I/O.



NEW

Note: The actual product is marked differently from the image shown here.

RoHS Compliant

Refer to "Common Precautions".

Application Examples

- Semiconductor test equipment
- Communication equipment
- Test & measurement equipment
- Data loggers

Terminal Arrangement/Internal Connections

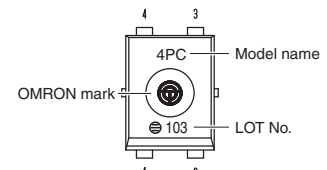
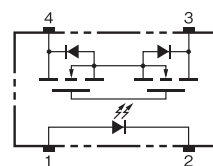

Note: The actual product is marked differently from the image shown here.

List of Models

Package type	Contact form	Terminals	Load voltage (peak value) (See note.)	Model	Minimum package quantity
					Number per tape & reel
USOP4	1a (SPST-NO)	Surface-mounting terminals	40V	G3VM-41PR12	-
				G3VM-41PR12 (TR05)	500
				G3VM-41PR12 (TR)	1,500

Note 1. Ask you OMRON representative for orders under 1,500 pcs or 500 pcs.

2. Tape-cut USOPs are packaged without humidity resistance. Use manual soldering to mount them. Refer to common precautions.

3. The AC peak and DC value is given for the load voltages.

Absolute Maximum Ratings (Ta = 25°C)

Item	Symbol	Rating	Unit	Measurement conditions	
Input	LED forward current	IF	50	mA	
	LED forward current reduction rate	ΔIF/°C	-0.5	mA/°C	Ta≥25°C
	LED reverse voltage	VR	5	V	
Connection temperature	TJ	125	°C		
Output	Load voltage (AC peak/DC)	V _{OFF}	40	V	
	Continuous load current (AC peak/DC)	Io	100	mA	
	ON current reduction rate	ΔIo/°C	-1.0	mA/°C	Ta≥25°C
	Pulse ON current	I _{op}	300	mA	t=100ms, Duty=1/10
	Connection temperature	TJ	125	°C	
Dielectric strength between I/O (See note 1.)	V _{I-O}	500	Vrms	AC for 1 min	
Ambient operating temperature	Ta	-40 ~ +85	°C	With no icing or condensation	
Ambient storage temperature	T _{stg}	-40 ~ +125	°C	With no icing or condensation	
Soldering temperature	-	260	°C	10s	

Note: 1. The dielectric strength between the input and output was checked by applying voltage between all pins as a group on the LED side and all pins as a group on the light-receiving side.

Electrical Characteristics (Ta = 25°C)

Item	Symbol	Minimum	Typical	Maximum	Unit	Measurement conditions	
Input	LED forward voltage	V _F	1.0	1.15	1.3	V	I _F =10mA
	Reverse current	I _R	-	-	10	μA	V _R =5V
	Capacity between terminals	C _T	-	15	-	pF	V=0, f=1MHz
	Trigger LED forward current	I _{FT}	-	1.0	3	mA	I _o =100mA
Output	Maximum resistance with output ON	R _{ON}	-	15	20	Ω	I _F =5mA, I _o =100mA, t<1s
	Current leakage when the relay is open	I _{LEAK}	-	-	1	nA	V _{OFF} =40V
	Capacity between terminals	C _{OFF}	-	0.3	0.6	pF	V=0, f=100MHz, t<1s
	Capacity between I/O terminals	C _{I-O}	-	0.4	-	pF	f=1MHz, V _s =0V
	Insulation resistance between I/O terminals	R _{I-O}	1000	-	-	MΩ	V _{I-O} =500VDC, R _{oH} ≤60%
Turn-ON time	t _{ON}	-	0.04	0.2	ms	I _F =5mA, R _L =200Ω, V _{DD} =20V (See note 2.)	
Turn-OFF time	t _{OFF}	-	0.12	0.2	ms		

Note: 2. Turn-ON and Turn-OFF Times

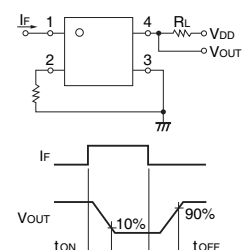

Recommended Operating Conditions

Use the G3VM under the following conditions so that the Relay will operate properly.

Item	Symbol	Minimum	Typical	Maximum	Unit
Load voltage (AC peak/DC)	V _{DD}	-	-	32	V
Operating LED forward current	I _F	5	7.5	20	mA
Continuous load current (AC peak/DC)	I _O	-	-	100	mA
Ambient operating temperature	T _a	-20	-	65	°C

Engineering Data

LED forward current vs. Ambient temperature

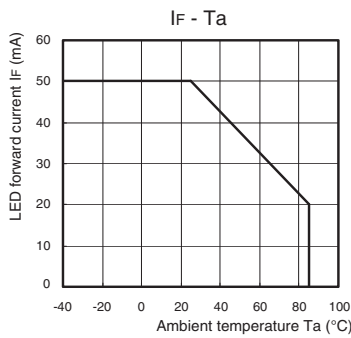

Continuous load current vs. Ambient temperature

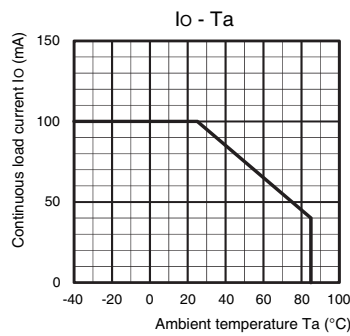

LED forward current vs. LED forward voltage

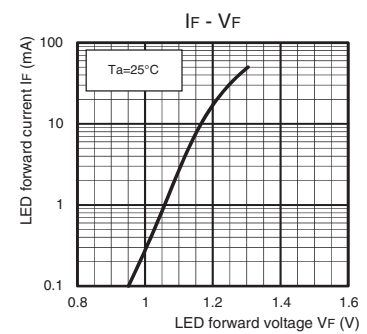

Continuous load current vs. On-state voltage

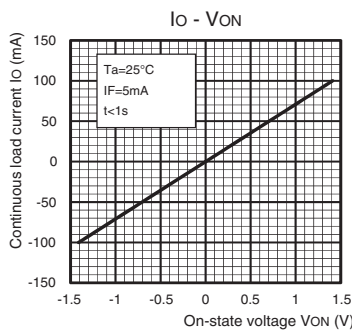

On-state resistance vs. Ambient temperature

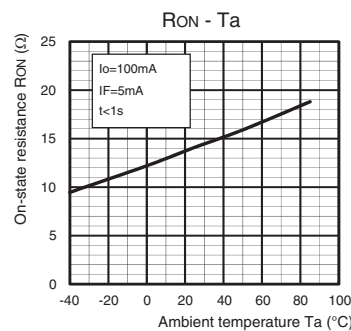

Trigger LED forward current vs. Ambient temperature

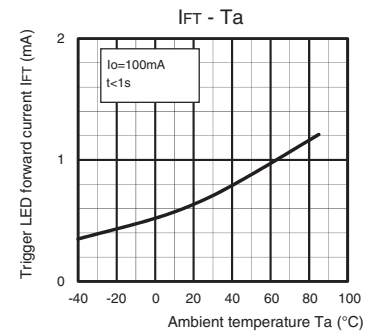

Turn ON, Turn OFF time vs. LED forward current

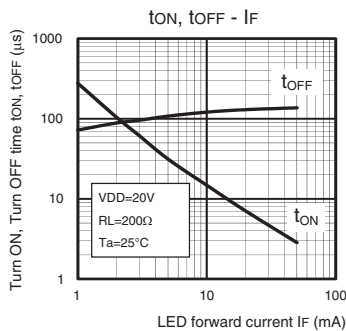

Turn ON, Turn OFF time vs. Ambient temperature

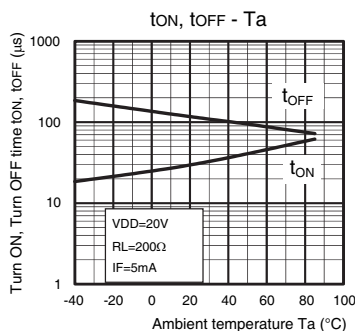

Current leakage vs. Load voltage

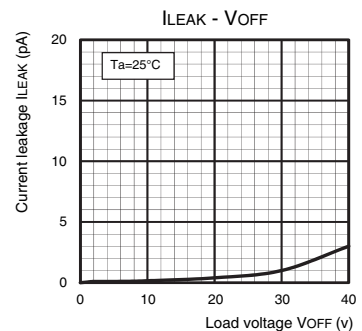

Output terminal capacitance COFF/COFF(ov) vs. Load voltage

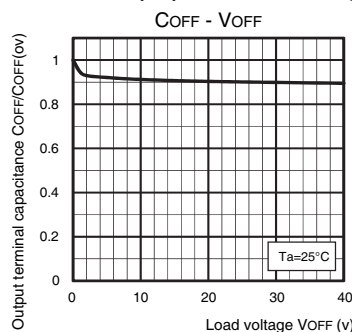

Safety Precautions

- Refer to "Common Precautions" for all G3VM models.

■ Appearance

USOP (Ultra Small Outline Package)
USOP4

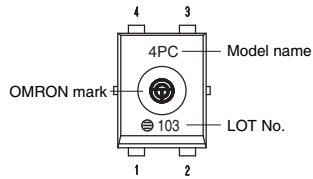

Note: The actual product is marked differently from the image shown here.

■ Dimensions

(Unit: mm)



Surface-mounting Terminals

Weight: 0.03g

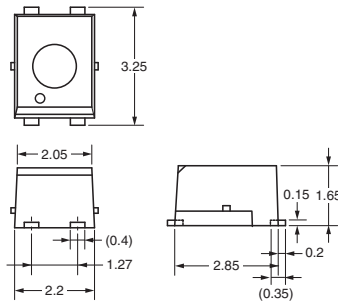

Actual Mounting Pad Dimensions

(Recommended Value, Top View)

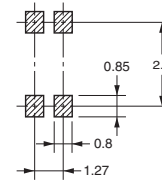

Note: The actual product is marked differently from the image shown here.

- Application examples provided in this document are for reference only. In actual applications, confirm equipment functions and safety before using the product.
- Consult your OMRON representative before using the product under conditions which are not described in the manual or applying the product to nuclear control systems, railroad systems, aviation systems, vehicles, combustion systems, medical equipment, amusement machines, safety equipment, and other systems or equipment that may have a serious influence on lives and property if used improperly. Make sure that the ratings and performance characteristics of the product provide a margin of safety for the system or equipment, and be sure to provide the system or equipment with double safety mechanisms.

Note: Do not use this document to operate the Unit.

OMRON Corporation

ELECTRONIC AND MECHANICAL COMPONENTS COMPANY

Contact: www.omron.com/ecb

Cat. No. **K208-E1-02**

1112(0912)(O)