

1 Form A Solid-State Relay

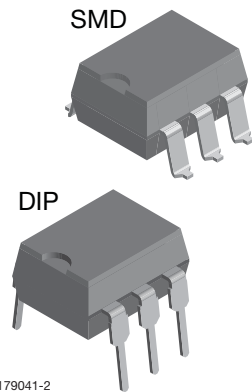

1179041-2

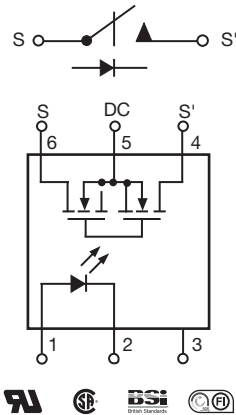

FEATURES

- Current limit protection
- Isolation test voltage 5300 V_{RMS}
- Typical R_{ON} 20 Ω
- Load voltage 350 V
- Load current 150 mA
- High surge capability
- Clean bounce free switching
- Low power consumption
- SMD lead available on tape and reel
- Compliant to RoHS Directive 2002/95/EC and in accordance to WEEE 2002/96/EC

RoHS
COMPLIANT

DESCRIPTION

The LH1500 is robust, ideal for telecom and ground fault applications. It is an SPST normally open switch (1 form A) that replaces electromechanical relays in many applications. It is constructed using a GaAlAs LED for actuation control and an integrated monolithic die for the switch output. The die, fabricated in a high-voltage dielectrically isolated technology, is comprised of a photodiode array, switch control circuitry and MOSFET switches. In addition, it employs current-limiting circuitry which meets lightning surge testing as per ANSI/TIA-968-B and other regulatory voltage surge requirements when overvoltage protection is provided.

APPLICATIONS

- General telecom switching
- Instrumentation
- Industrial controls

AGENCY APPROVALS

UL1577: file no. E52744 system code H, double protection
 CSA: certification 093751
 BSI: no. 7979 and 7980
 FIMKO: 25419

ORDERING INFORMATION

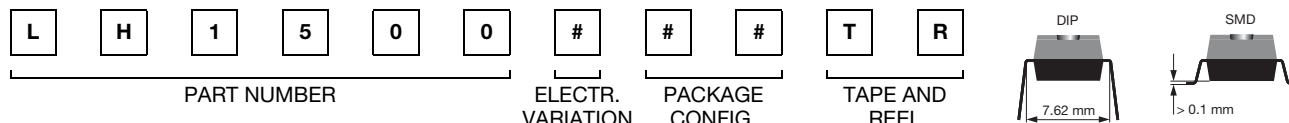

| PACKAGE | UL, CSA, BSI, FIMKO |
|----------------------|---------------------|
| SMD-6 | LH1500AAB |
| SMD-6, tape and reel | LH1500AABTR |
| DIP-6, thru hole | LH1500AT |



| ABSOLUTE MAXIMUM RATINGS (T _{amb} = 25 °C, unless otherwise specified) | | | | |
|---|--|-------------------|--------------------|------------------|
| PARAMETER | TEST CONDITION | SYMBOL | VALUE | UNIT |
| INPUT | | | | |
| SSR output power dissipation (continuous) | | P _{diss} | 550 | mW |
| LED reverse voltage | I _R ≤ 10 mA | V _R | 8 | V |
| LED continuous forward current | | I _F | 50 | mA |
| OUTPUT | | | | |
| DC or peak AC load voltage | I _L ≤ 50 mA | V _L | 350 | V |
| Continuous DC load current - bidirectional | T _{amb} = 25 °C | I _L | 150 | mA |
| Continuous DC load current - unidirectional | T _{amb} = 25 °C | I _L | 250 | mA |
| SSR | | | | |
| Ambient temperature range | | T _{amb} | - 40 to + 85 | °C |
| Storage temperature range | | T _{stg} | - 40 to + 150 | °C |
| Soldering temperature ⁽¹⁾ | t = 10 s maximum | T _{sld} | 260 | °C |
| Isolation test voltage (for 1 s) | | V _{ISO} | 5300 | V _{RMS} |
| Isolation resistance | V _{IO} = 500 V, T _{amb} = 25 °C | R _{IO} | ≥ 10 ¹² | Ω |
| | V _{IO} = 500 V, T _{amb} = 100 °C | R _{IO} | ≥ 10 ¹¹ | Ω |

Notes

- Stresses in excess of the absolute maximum ratings can cause permanent damage to the device. Functional operation of the device is not implied at these or any other conditions in excess of those given in the operational sections of this document. Exposure to absolute maximum ratings for extended periods of the time can adversely affect reliability.

⁽¹⁾ Refer to reflow profile for soldering conditions for surface mounted devices (SMD). Refer to wave profile for soldering conditions for through hole devices (DIP).

| ELECTRICAL CHARACTERISTICS (T _{amb} = 25 °C, unless otherwise specified) | | | | | | |
|---|---|-------------------|------|------|------|------|
| PARAMETER | TEST CONDITION | SYMBOL | MIN. | TYP. | MAX. | UNIT |
| INPUT | | | | | | |
| LED forward current, switch turn-on | I _L = 100 mA, t = 10 ms | I _{Fon} | | 0.9 | 2 | mA |
| LED forward current, switch turn-off | V _L = ± 300 V | I _{Foff} | 0.2 | 0.8 | | mA |
| LED forward voltage | I _F = 10 mA | V _F | 1.15 | 1.25 | 1.45 | V |
| OUTPUT | | | | | | |
| On-resistance, AC/DC: pin 4 (±) to 6 (±) | I _F = 5 mA, I _L = 50 mA | R _{ON} | | 20 | 25 | Ω |
| On-resistance, DC: pin 4, 6 (+) to 5 (-) | I _F = 5 mA, I _L = 100 mA | R _{ON} | 3 | 4.6 | 6.25 | Ω |
| Off-resistance | I _F = 0 mA, V _L = ± 100 V | R _{OFF} | 0.5 | 300 | | GΩ |
| Current limit AC ⁽¹⁾ : pin 4 (±) to 6 (±) | I _F = 5 mA, t = 5 ms, V _L = ± 6 V | I _{LMT} | 230 | 255 | 370 | mA |
| Off-state leakage current | I _F = 0 mA, V _L = ± 100 V | I _O | | 0.32 | 200 | nA |
| | I _F = 0 mA, V _L = ± 350 V | I _O | | | 1 | μA |
| Output capacitance, pin 4 to 6 | I _F = 0 mA, V _L = 1 V | C _O | | 33 | | pF |
| | I _F = 0 mA, V _L = 50 V | C _O | | 10 | | pF |
| Switch offset | I _F = 5 mA | V _{OS} | | 0.2 | | μV |
| TRANSFER | | | | | | |
| Capacitance (input to output) | V _{ISO} = 1 V | C _{IO} | | 0.71 | | pF |

Notes

- Minimum and maximum values are testing requirements. Typical values are characteristics of the device and are the result of engineering evaluations. Typical values are for information only and are not part of the testing requirements.

⁽¹⁾ No DC mode current limit available.

| SWITCHING CHARACTERISTICS (T _{amb} = 25 °C, unless otherwise specified) | | | | | | |
|--|---|------------------|------|------|------|------|
| PARAMETER | TEST CONDITION | SYMBOL | MIN. | TYP. | MAX. | UNIT |
| Turn-on time | I _F = 5 mA, I _L = 50 mA | t _{on} | | 0.3 | 2 | ms |
| Turn-off time | I _F = 5 mA, I _L = 50 mA | t _{off} | | 0.6 | 2 | ms |

TYPICAL CHARACTERISTICS ($T_{amb} = 25\text{ }^{\circ}\text{C}$, unless otherwise specified)

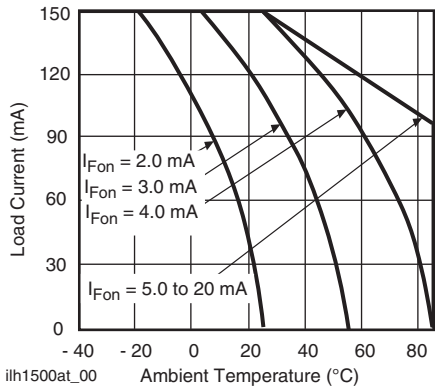

Fig. 1 - Recommended Operating Conditions

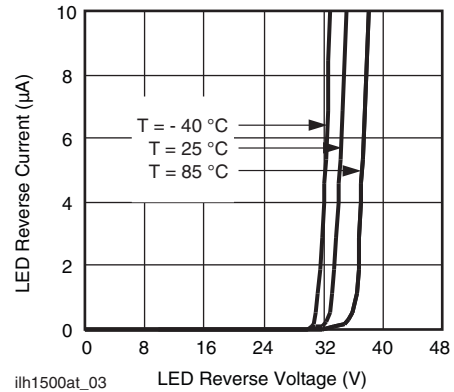

Fig. 4 - LED Reverse Current vs. LED Reverse Voltage

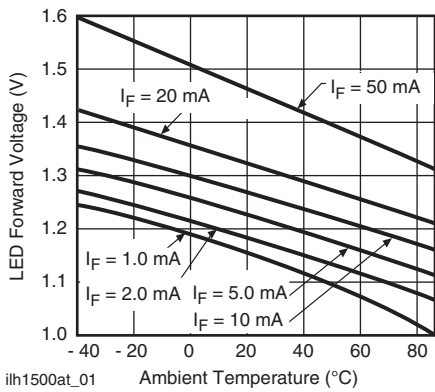

Fig. 2 - LED Voltage vs. Temperature

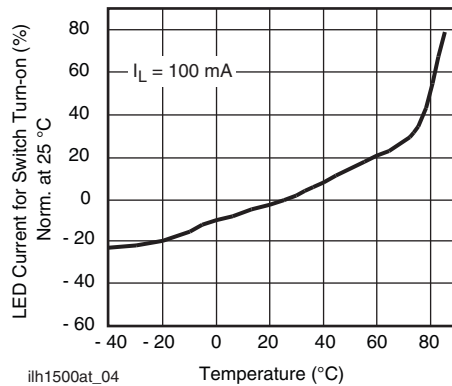

Fig. 5 - LED Current for Switch Turn-on vs. Temperature

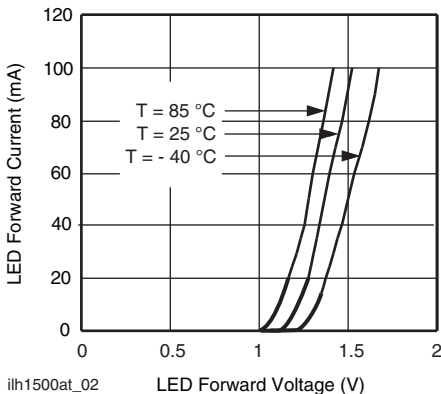

Fig. 3 - LED Forward Current vs. Forward Voltage

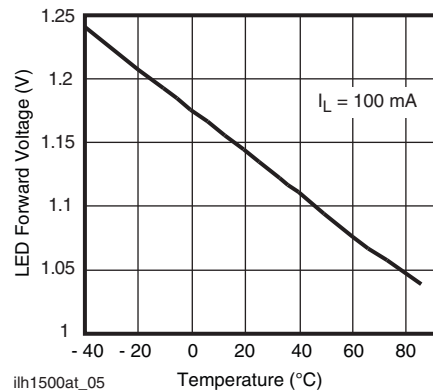

Fig. 6 - LED Dropout Voltage vs. Temperature

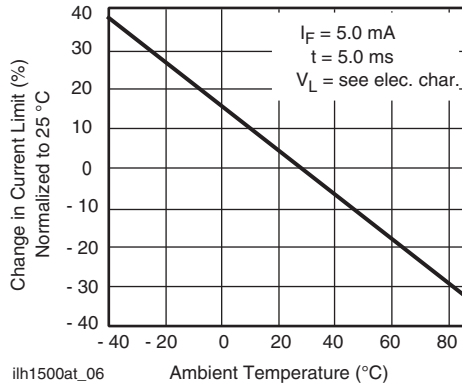

Fig. 7 - Current Limit vs. Temperature

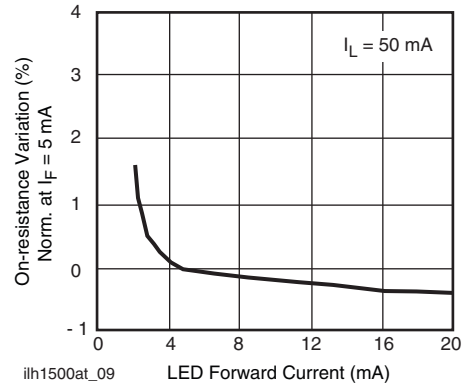

Fig. 10 - Variation in On-Resistance vs. LED Current

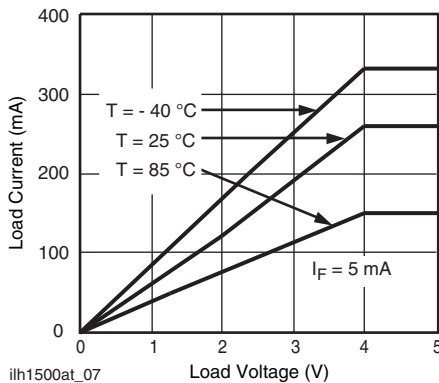

Fig. 8 - Load Current vs. Load Voltage

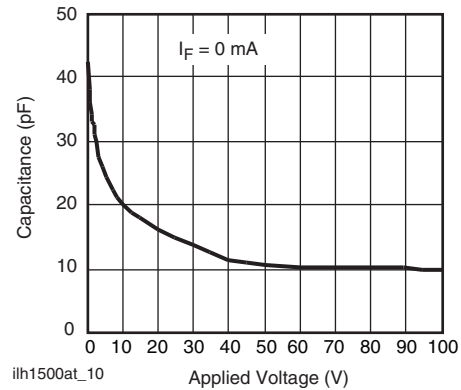

Fig. 11 - Switch Capacitance vs. Applied Voltage

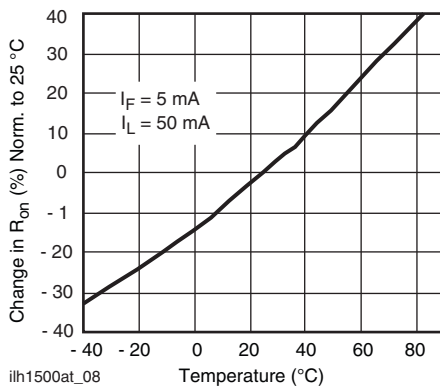

Fig. 9 - On-Resistance vs. Temperature

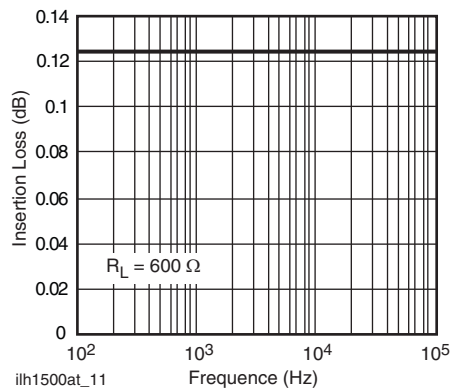

Fig. 12 - Insertion Loss vs. Frequency

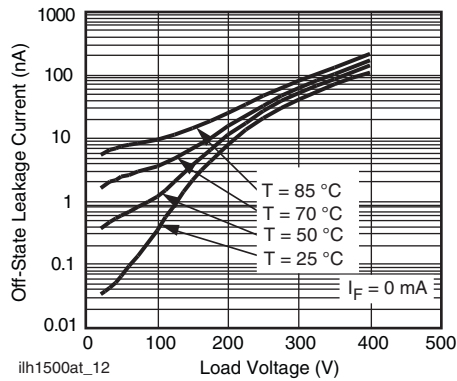

Fig. 13 - Leakage Current vs. Applied Voltage

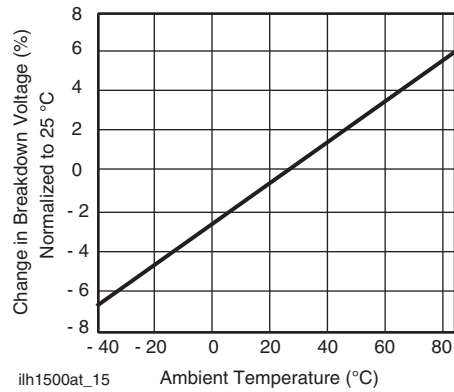

Fig. 16 - Switch Breakdown Voltage vs. Temperature

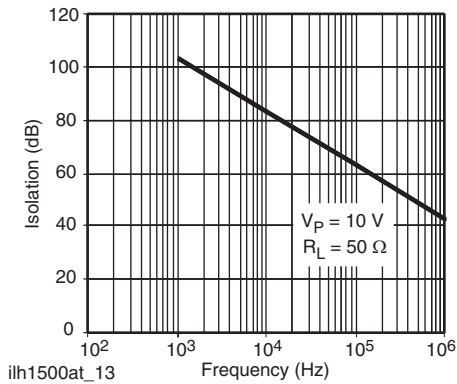

Fig. 14 - Output Isolation

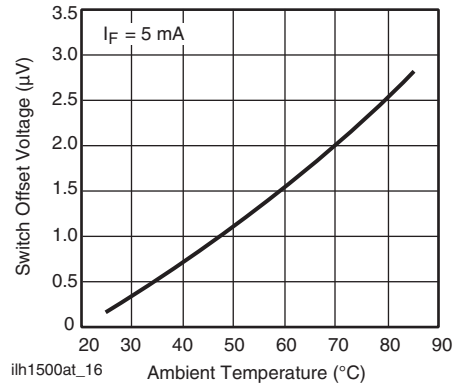

Fig. 17 - Switch Offset Voltage vs. Temperature

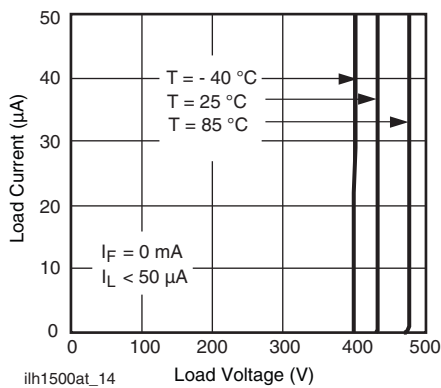

Fig. 15 - Switch Breakdown Voltage vs. Load Current

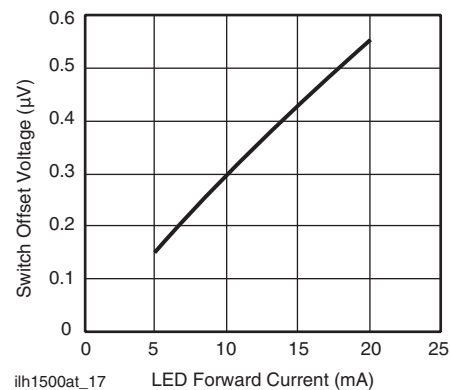

Fig. 18 - Switch Offset Voltage vs. LED Current

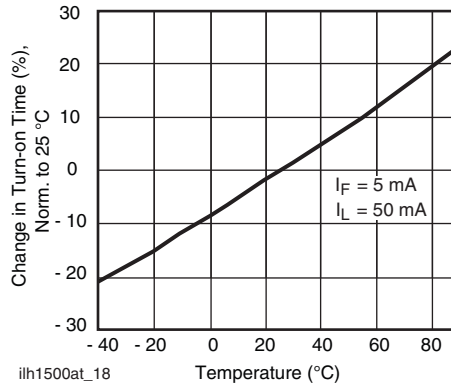

Fig. 19 - Turn-on Time vs. Temperature

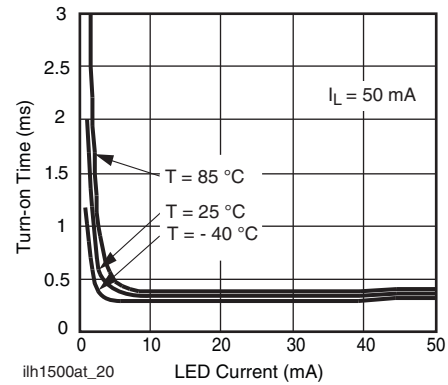

Fig. 21 - Turn-on Time vs. LED Current

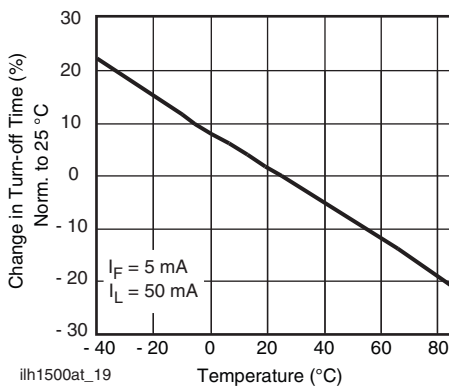

Fig. 20 - Turn-off Time vs. Temperature

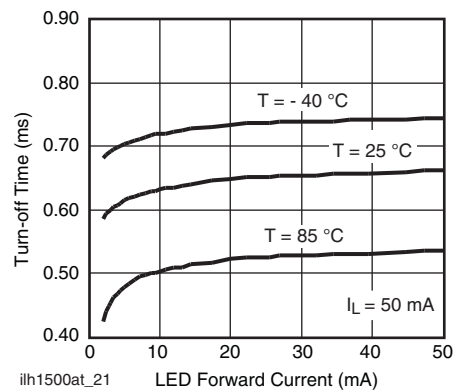
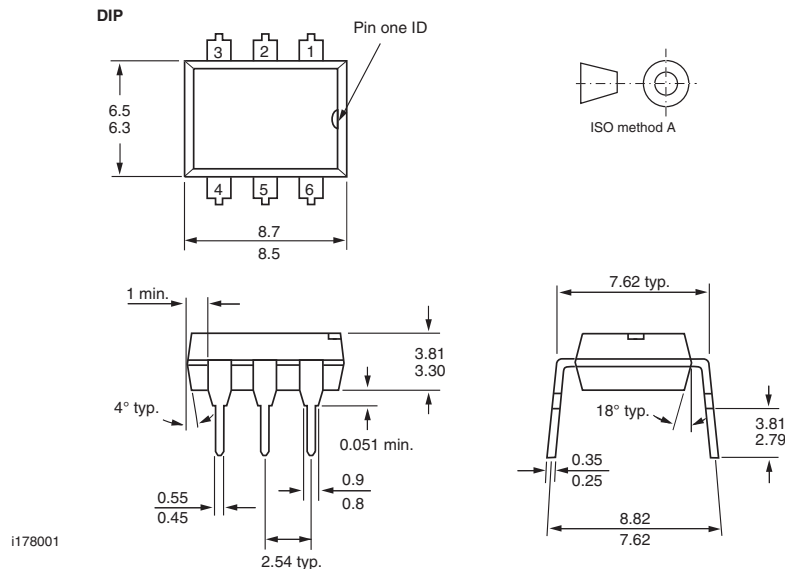
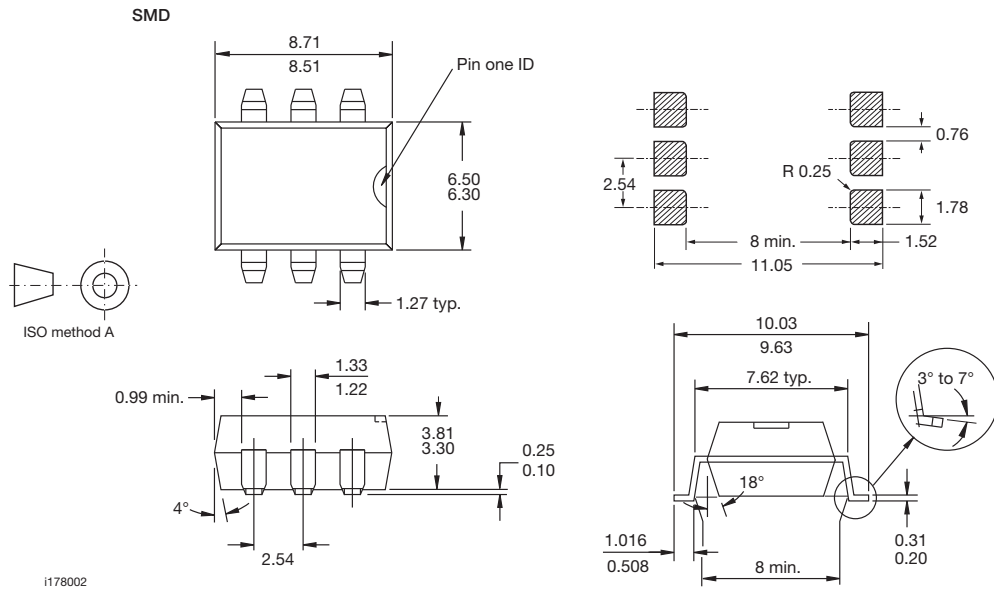

Fig. 22 - Turn-off Time vs. LED Current

PACKAGE DIMENSIONS in millimeters





PACKAGE MARKING

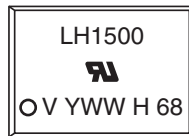

Note

- Tape and reel suffix (TR) is not part of the package marking.



Disclaimer

ALL PRODUCT, PRODUCT SPECIFICATIONS AND DATA ARE SUBJECT TO CHANGE WITHOUT NOTICE TO IMPROVE RELIABILITY, FUNCTION OR DESIGN OR OTHERWISE.

Vishay Intertechnology, Inc., its affiliates, agents, and employees, and all persons acting on its or their behalf (collectively, "Vishay"), disclaim any and all liability for any errors, inaccuracies or incompleteness contained in any datasheet or in any other disclosure relating to any product.

Vishay makes no warranty, representation or guarantee regarding the suitability of the products for any particular purpose or the continuing production of any product. To the maximum extent permitted by applicable law, Vishay disclaims (i) any and all liability arising out of the application or use of any product, (ii) any and all liability, including without limitation special, consequential or incidental damages, and (iii) any and all implied warranties, including warranties of fitness for particular purpose, non-infringement and merchantability.

Statements regarding the suitability of products for certain types of applications are based on Vishay's knowledge of typical requirements that are often placed on Vishay products in generic applications. Such statements are not binding statements about the suitability of products for a particular application. It is the customer's responsibility to validate that a particular product with the properties described in the product specification is suitable for use in a particular application. Parameters provided in datasheets and/or specifications may vary in different applications and performance may vary over time. All operating parameters, including typical parameters, must be validated for each customer application by the customer's technical experts. Product specifications do not expand or otherwise modify Vishay's terms and conditions of purchase, including but not limited to the warranty expressed therein.

Except as expressly indicated in writing, Vishay products are not designed for use in medical, life-saving, or life-sustaining applications or for any other application in which the failure of the Vishay product could result in personal injury or death. Customers using or selling Vishay products not expressly indicated for use in such applications do so at their own risk. Please contact authorized Vishay personnel to obtain written terms and conditions regarding products designed for such applications.

No license, express or implied, by estoppel or otherwise, to any intellectual property rights is granted by this document or by any conduct of Vishay. Product names and markings noted herein may be trademarks of their respective owners.

Material Category Policy

Vishay Intertechnology, Inc. hereby certifies that all its products that are identified as RoHS-Compliant fulfill the definitions and restrictions defined under Directive 2011/65/EU of The European Parliament and of the Council of June 8, 2011 on the restriction of the use of certain hazardous substances in electrical and electronic equipment (EEE) - recast, unless otherwise specified as non-compliant.

Please note that some Vishay documentation may still make reference to RoHS Directive 2002/95/EC. We confirm that all the products identified as being compliant to Directive 2002/95/EC conform to Directive 2011/65/EU.

Vishay Intertechnology, Inc. hereby certifies that all its products that are identified as Halogen-Free follow Halogen-Free requirements as per JEDEC JS709A standards. Please note that some Vishay documentation may still make reference to the IEC 61249-2-21 definition. We confirm that all the products identified as being compliant to IEC 61249-2-21 conform to JEDEC JS709A standards.