

### FEATURES

- 14-BIT Resolution and Accuracy
- Fast 12 $\mu$ s Conversion Time (ADC1131J/K)
- Low 10ppm/ $^{\circ}$ C Maximum Gain TC
- User Choice of Input Range
- No Missing Codes

### APPLICATIONS

- Wide Band Data Digitizing
- Multi-Channel Computer Interface
- High Accuracy Data Acquisition
- X-Ray Tomography
- Nuclear Accelerator Instrumentation

### GENERAL DESCRIPTION

The ADC1130 and ADC1131 are high speed analog-to-digital converters packaged in a small 2" x 4" x 0.4" (51 x 102 x 10mm) module, which perform complete 14-bit conversions in 25 $\mu$ s and 12 $\mu$ s respectively. Using the successive approximations technique, they convert analog input voltages into natural binary, offset binary, or two's complement coded outputs. Data outputs are provided in both parallel and non-return-to-zero serial form.

Four analog input ranges are available: 0 to +20V, 0 to +10V,  $\pm$ 10V,  $\pm$ 5V. The user selects the desired range by making appropriate connections to the module terminals. The ADC1130 and ADC1131 can also be connected so as to perform conversions of less than 14 bit resolution with a proportionate decrease in conversion time.

### TIMING

As shown in Figure 1, the leading edge of the convert command set the MSB output to Logic "0" and the CLOCK OUT, STATUS, MSB, and BIT 2 through BIT 12 outputs to Logic "1". Nothing further happens until the convert command returns to Logic "0", at which time the clock starts to run and the conversion proceeds.

With the MSB in the Logic "0" state, the internal digital-to-analog converter's output is compared with the analog input. If the D/A output is less than the analog input, the first "0" to "1" clock transition resets the MSB to Logic "1". If the D/A output is greater than the analog input, the MSB remains at Logic "0".

The first "0" to "1" clock transition also sets the BIT 2 output to Logic "0" and another comparison is made. This process continues through each successive bit until the BIT 14 (LSB) com-

### ADC1131 TIMING DIAGRAM

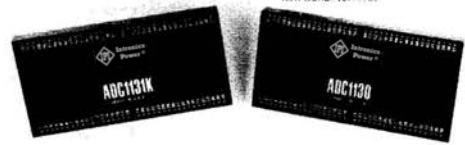
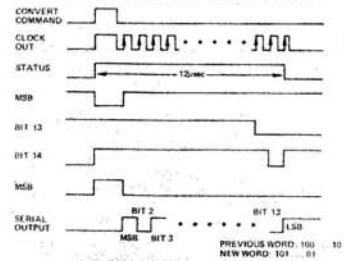

parison is completed. At this point the STATUS and CLOCK OUT return to Logic "0" and the conversion cycle ends.

The serial data output is of the non-return-to-zero (NRZ) format. The data is available, MSB first, 20ns after each of the fourteen "0" to "1" clock transitions.

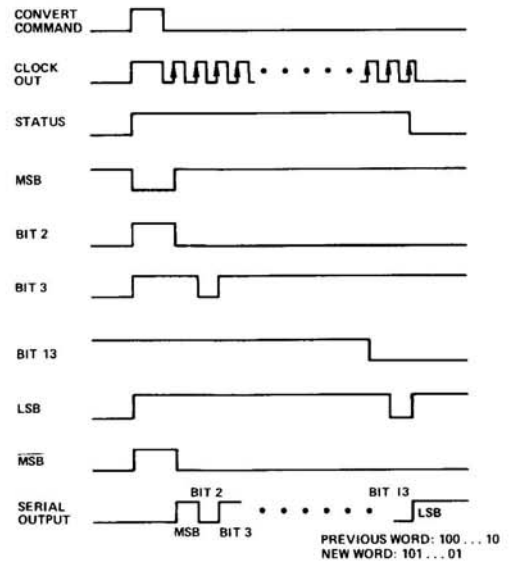

Figure 1. Timing Diagram

# SPECIFICATIONS (typical @ +25°C unless otherwise noted)

MODEL	HIGH SPEED 12μs ADC1131		MEDIUM SPEED 25μs ADC1130
	J	K	
RESOLUTION, BITS	14	14	14
CONVERSION TIME (max)	12μs	12μs	25μs
ACCURACY			
Integral Nonlinearity Error (LSB)	±1/2 (max)	*	*
Differential Nonlinearity Error (LSB)	±1/2 (1 max)	±1/2 (max)	±1/2 (1 max)
Missing Codes	No missing codes	*	*
TEMPERATURE COEFFICIENTS			
Gain ppm/°C	±12 (max)	±7 (+10 max)	±12 max
Unipolar Offset	±0.7 (±3 max)	*	*
Bipolar Offset	±3 (±7 max)	*	*
INPUT VOLTAGE RANGES	±5V, ±10V, +10V, +20V	*	*
INPUT IMPEDANCE (10V RANGE)	2500Ω	*	*
CONVERT COMMAND	Positive Pulse, 200ns min, 400ns max Leading Edge Resets, Trailing Edge Starts, TTL/DTL Compatible	*	*
PARALLEL DATA OUTPUT			
Unipolar	Positive True Binary	*	*
Bipolar	Positive True Offset Binary, Two's Complement	*	*
SERIAL DATA OUTPUT			
Unipolar	Positive True Binary	*	*
Bipolar	Positive True Offset Binary	*	*
STATUS OUTPUT	"1" During Conversion. Complement also available TTL/DTL Compatible.	*	*
LOGIC FANOUTS AND LOADINGS			
Convert Command Input	1TTL Unit Load	*	*
Clock Input	3TTL Unit Loads	*	*
Short Cycle Input	1TTL Unit Load	*	*
Parallel Data Outputs	3TTL Unit Loads/Bit	*	*
Serial Data Output	8TTL Unit Loads	*	*
STATUS Output	2TTL Unit Loads	*	*
STATUS Output	12TTL Unit Loads	*	*
Clock Output	4TTL Unit Loads	*	*
POWER REQUIREMENTS	+15V ±5% @ 40mA -15V ±5% @ 60mA +5V ±5% @ 250mA	*	*
POWER SUPPLY SENSITIVITY			
To ±15V Tracking Supplies			
Gain	±4.5ppm/%ΔV <sub>S</sub>	*	*
Zero	±4.5ppm/%ΔV <sub>S</sub>	*	*
To ±15V Non-Tracking Supplies			
Gain	±10ppm/%ΔV <sub>S</sub>	*	*
Zero	±7ppm/%ΔV <sub>S</sub>	*	*
TEMPERATURE RANGE			
Operating	0 to +70°C	*	*
Storage	-55°C to +85°C	*	*

\*Same Specifications as ADC1131J.

**NOTES:**

<sup>1</sup> Offset (zero) and gain errors are adjustable to zero by means of external potentiometers. See Figure 5 for proper connection.

<sup>2</sup> Recommended power supply: Analog Devices model 923.

Specifications subject to change without notice.

## OUTLINE DIMENSIONS

Dimensions shown in inches and (mm).

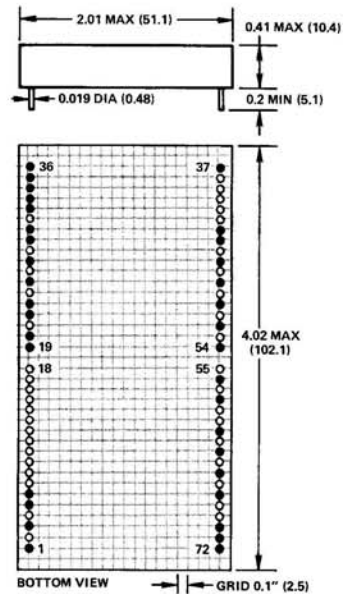

**NOTE:**

Terminal pins installed only in shaded hot locations.

Module weight: 3.5 ounces (99.3 grams). All pins are gold plated half-hard brass (MIL-G-45204), 0.019" ±0.001" (0.48 ±0.03mm) dia.

For plug-in mounting card order Board No. AC1578.

## BLOCK DIAGRAM AND PIN DESIGNATIONS

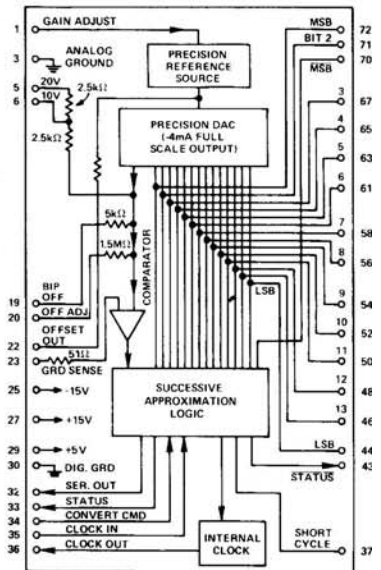

# Applying the ADC1130, ADC1131

## ANALOG INPUT CHARACTERISTICS

The input circuit of the ADC1130 and ADC1131 are shown in block diagram form.

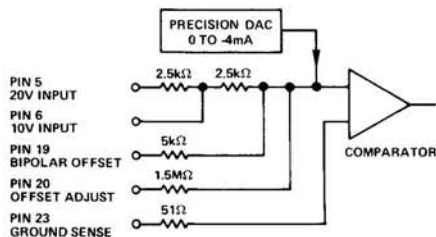

Figure 2. Input Circuit Block Diagram

When the converters are connected as a unipolar device, Pin 19 is left open circuit and, thus, no offset current is applied to the comparator input. The 0 to +10V input signal applied to Pin 6 (or the 0 to +20V input signal applied to Pin 5) develops a 0 to +4mA current which is compared to the 0 to -4mA output of the D/A converter. A voltage between +15V and -15V can be applied to Pin 20 from the wiper of a 100kΩ potentiometer to adjust the zero point by  $\pm 40$ LSB. To reduce the range of this trim padding resistors should be used.

With the offset output, Pin 22, connected to Pin 19, a +2mA offset current is applied to the comparator input. The ADC1130 and ADC1131 will then accept bipolar inputs of  $\pm 5$ V at Pin 6, or  $\pm 10$ V at Pin 5 and compare the 0 to +4mA sum of the offset and input signal currents to the 0 to -4mA D/A converter output. The offset adjustment potentiometer is once again used as described in the preceding paragraph.

Signal ground sense, Pin 23, should normally be jumpered to analog ground, Pin 3. In the event that an offset voltage is developed in the ground wiring, it may be possible to eliminate its effect by connecting Pin 23 directly to the signal or analog ground of the device feeding the analog input signal to the ADC. In any case, Pin 23 must not be left open.

If a high input impedance is required, it can be achieved by using a high speed operational amplifier as an input buffer.

## PARALLEL DATA OUTPUT

These converters produce natural Binary Coded outputs when configured as a unipolar device. As a bipolar device, they can produce either Offset Binary or Two's Complement output codes. The most significant bit is represented by Pin 72 (MSB output) for Binary and Offset Binary codes, or by Pin 70 (MSB output) for the Two's Complement code. Tables I and II illustrate the relationship between analog input and digital output for all three codes.

ANALOG INPUT		DIGITAL OUTPUT
0 to +10V Range	0 to +20V Range	Binary Code
+9.9994V	+19.9988V	11111111111111
+5.0000V	+10.0000V	10000000000000
+1.2500V	+2.5000V	00100000000000
+0.0006V	+0.0012V	00000000000001
+0.0000V	+0.0000V	00000000000000

Table I. Nominal Unipolar Input-Output Relationships

$\pm 5$ V Range	$\pm 10$ V Range	Offset Binary Code	Two's Complement Code
+4.9994V	+9.9988V	11111111111111	01111111111111
+2.5000V	+5.0000V	11000000000000	01000000000000
+0.0006V	+0.0012V	10000000000001	00000000000001
+0.0000V	+0.0000V	10000000000000	00000000000000
-5.0000V	-10.0000V	00000000000000	10000000000000

Table II. Nominal Bipolar Input-Output Relationships

## SERIAL DATA OUTPUT

The serial data output, available on Pin 32, is of the non-return-to-zero format. The data is transmitted MSB first and is Binary coded for unipolar units and Offset Binary coded for bipolar unit

Figure 3, shown below, indicates one method for transmitting data serially using only three wires (plus a digital ground). The data is clocked into a receiving shift register using the delayed clock output of the converter.

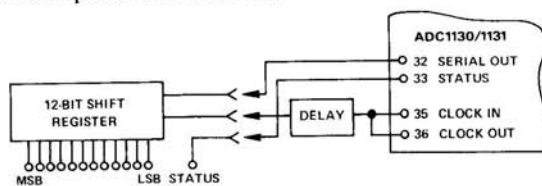

Figure 3. Serial Data Transmission

The timing diagram presented in Figure 4 shows that the converter's clock output must be delayed by an amount of time greater than or equal to the sum of the receiving shift register setup time plus the 20ns clock output to serial output delay.

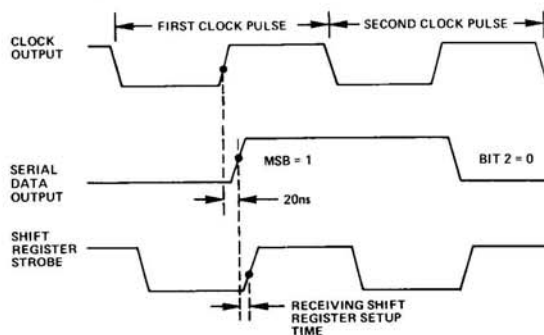

Figure 4. Serial Data Timing Diagram

The 50ns span between the time that the last serial output bit is available and the time that the STATUS output returns to zero insures that the data in the shift register will be valid on the "1" to "0" transition of the STATUS signal.

## GAIN AND OFFSET ADJUSTMENTS

The potentiometers used for making gain and offset adjustments are connected as shown in Figure 5. Note that a jumper

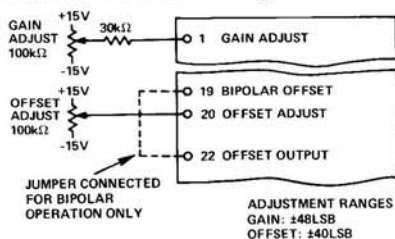

Figure 5. Adjustment Connections

is connected between Pin 19 and Pin 22 for bipolar operation; these pins *must* be left open for unipolar operation.

Proper gain and offset calibration requires great care and the use of extremely sensitive and accurate reference instruments. The voltage standard used as a signal source must be very stable. It should be capable of being set to within  $1\mu\text{V}$  of the desired value at both ends of its range.

The gain and offset calibrations will be independent of each other if the offset adjustment is made first. These adjustments are not made with zero and full scale input signals and it may be helpful to understand why. An A/D converter will produce a given digital output for a small range of input signals, the nominal width of the range being one LSB. If the input test signal is set to a value which should cause the output of the converter to be on the verge of switching from one digital value to the adjacent digital value, the unit can be calibrated so that it does change values at just that point. With a high speed convert command rate and a visual display, these adjustments can be performed in a very accurate and sensitive way. Analog Devices' *Analog-Digital Conversion Notes* gives more detailed information on testing and calibrating A/D and D/A converters.

#### OFFSET CALIBRATION

For the 0 to +10V unipolar range set the input voltage precisely to +0.0003V; for 0 to +20V units set it to +0.0006V. Adjust the zero potentiometer until the converter is just on the verge of switching from 00 . . . . 0 to 00 . . . . 1.

For the  $\pm 5\text{V}$  bipolar range set the input voltage precisely to -4.9997V; for  $\pm 10\text{V}$  units set it to -9.9994V. Adjust the zero potentiometer until offset binary coded units are just on the verge of switching from 00 . . . . 0 to 00 . . . . 1 and two's complement coded units are just on the verge of switching from 100 . . . 0 to 100 . . . 1.

#### GAIN CALIBRATION

Set the input voltage precisely to +19.9982V for 0 to +20V units, +9.9991V for 0 to +10V units, +4.9991V for  $\pm 5\text{V}$  units, or +9.9982V for  $\pm 10\text{V}$  units. Note that these values are  $1/2\text{LSB}$ 's less than nominal full scale. Adjust the gain potentiometer until binary and offset binary coded units are just on the verge of switching from 11 . . . 0 to 11 . . . 1 and two's complement coded units are just on the verge of switching from 011 . . . 10 to 011 . . . 11.

#### POWER SUPPLY AND GROUNDING CONNECTIONS

These converters do not have an internal connection between analog power ground and digital ground and, thus, a connection must be provided in the external circuitry. The choice of an optimum "star" point for these grounds is an important consideration in the performance of the system. No strict rules can be given, only the general guidelines that the grounding should be arranged in such a manner as to avoid ground loops and to minimize the coupling of voltage drops (on the high current carrying logic supply ground) to the sensitive analog circuit sections. One suggested approach is shown in Figure 6.

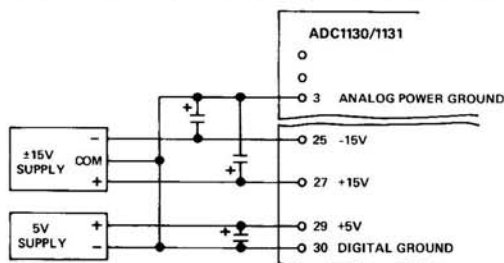

Figure 6. Power Supply and Grounding Connections

The  $\pm 15\text{V}$  and +5V power supplies must be externally bypassed with  $15\mu\text{F}$  (+35V tantalum) capacitors. These capacitors should be connected between Pin 27 and Pin 3, between Pin 25 and Pin 3, and between Pin 29 and Pin 30. Capacitor connections should be made as close to the module pins as possible.

#### CLOCK CONNECTIONS

When the converters are used with their own internal clock, Pin 36 is simply jumpered to Pin 35. When the internal clock is not used, Pin 36 is grounded and an external clock capable of driving three TTL loads is connected to Pin 35. The convert command should be synchronized with the external clock.

#### REPETITIVE CONVERSIONS

When making repetitive conversions, a new convert command may be initiated any time after the "1" to "0" transition of the STATUS output. The STATUS output may not, however, be connected directly to the CONVERT COMMAND input for the purpose of automatically generating convert command pulses.

#### SHORT CYCLE CONNECTIONS

When the converters are operated as a 14-bit device, Pin 37 is left open. If, however, it is to perform conversions of less than 14 bits, Pin 37 is connected to the N+1 bit output (where N is the number of bits in the conversion). The conversion time in this mode of operation is  $T_C \times N/14$  where  $T_C$  is the conversion time of the particular model when operated at 14-bit resolution.

#### THE AC1578 MOUNTING CARD

The AC1578 mounting card is specifically designed to be used with Analog Devices high resolution, high speed analog-to-digital converters, models ADC1130 and ADC1131. This  $4.5'' \times 3.56''$  (114 X 90mm) printed circuit card, shown in Figure 7, has sockets which allow the converter to be plugged directly onto it. It contains an input buffer that can be programmed using on-board jumpers to provide the input ranges of 0-10 volts,  $\pm 10$  volts, or  $\pm 5$  volts. Additionally, a 0-20 volt input range can be achieved by wiring the AC1578 without utilizing the buffer.

The analog information has been isolated from the digital information by the use of two separate connectors, one at the top (designated "P1") and one at the bottom (designated "P2") of the AC1578. Both connectors P1 and P2 are supplied with each card. Whenever feasible, the top connector should be used for analog interfacing to eliminate crosstalk.

Additional wiring information and calibration procedure are contained in a separate data sheet for the AC1578 which is shipped with the card and is available on request.

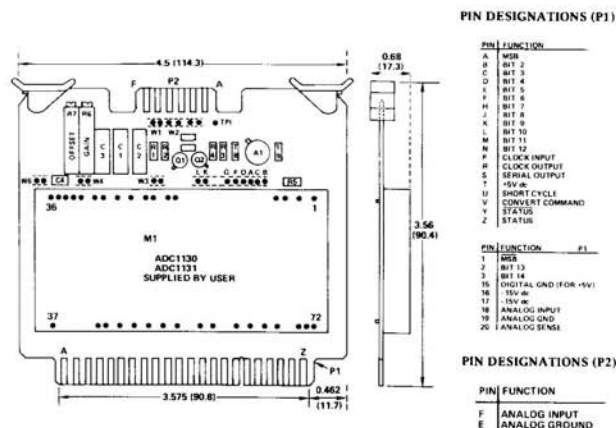

Figure 7. AC1578 Mounting Card