

High Speed Optocoupler, 1 MBd, Photodiode with Transistor Output

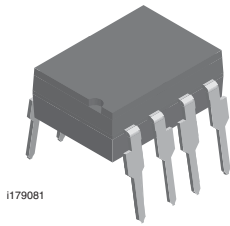

i179081

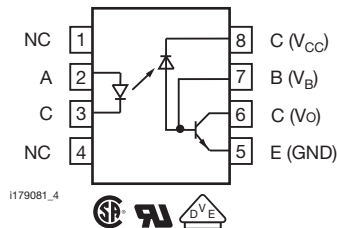

i179081_4



FEATURES

- Isolation test voltages: 5300 V_{RMS}
- TTL compatible
- High bit rates: 1 Mbit/s
- High common-mode interference immunity
- Bandwidth 2 MHz
- Open-collector output
- External base wiring possible
- Compliant to RoHS Directive 2002/95/EC and in accordance to WEEE 2002/96/EC

RoHS
COMPLIANT

DESCRIPTION

The 6N135 and 6N136 are optocouplers with a GaAlAs infrared emitting diode, optically coupled with an integrated photo detector which consists of a photo diode and a high-speed transistor in a DIP-8 plastic package.

Signals can be transmitted between two electrically separated circuits up to frequencies of 2 MHz. The potential difference between the circuits to be coupled should not exceed the maximum permissible reference voltages.

AGENCY APPROVALS

- UL1577, file no. E52744 system code H double protection
- DIN EN 60747-5-2 (VDE0884)/DIN EN 60747-5-5 (pending), available with option 1
- CSA 93751

ORDERING INFORMATION

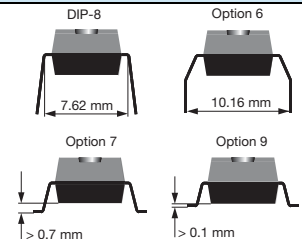
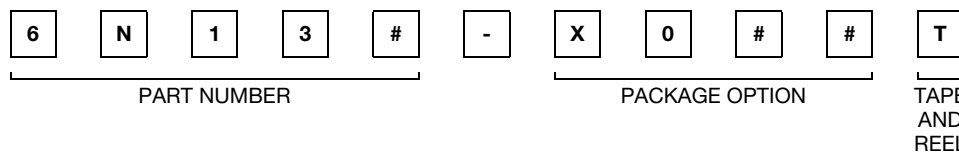

AGENCY CERTIFIED/PACKAGE	CTR (%)	
UL, CSA	≥ 7	≥ 19
DIP-8	6N135	6N136
DIP-8, 400 mil, option 6	-	6N136-X006
SMD-8, option 7	6N135-X007T ⁽¹⁾	6N136-X007T ⁽¹⁾
SMD-8, option 9	-	6N136-X009T ⁽¹⁾
VDE, UL, CSA	≥ 7	≥ 19
DIP-8	-	6N136-X001
DIP-8, 400 mil, option 6	-	6N136-X016
SMD-8, option 7	6N135-X017T ⁽¹⁾	6N136-X017T
SMD-8, option 9	-	6N136-X019T

Note

⁽¹⁾ Also available in tubes; do not add T to end

ABSOLUTE MAXIMUM RATINGS (T_{amb} = 25 °C, unless otherwise specified)

PARAMETER	TEST CONDITION	SYMBOL	VALUE	UNIT
INPUT				
Reverse voltage		V _R	5	V
Forward current		I _F	25	mA
Peak forward current	t = 1 ms, duty cycle 50 %	I _{FSM}	50	mA
Maximum surge forward current	t ≤ 1 μs, 300 pulses/s		1	A
Thermal resistance		R _{th}	700	K/W
Power dissipation	T _{amb} = 70 °C	P _{diss}	45	mW



ABSOLUTE MAXIMUM RATINGS ($T_{amb} = 25\text{ }^{\circ}\text{C}$, unless otherwise specified)				
PARAMETER	TEST CONDITION	SYMBOL	VALUE	UNIT
OUTPUT				
Supply voltage		V_S	- 0.5 to 15	V
Output voltage		V_O	- 0.5 to 15	V
Emitter base voltage		V_{EBO}	5	V
Output current		I_O	8	mA
Maximum output current			16	mA
Base current		I_B	5	mA
Thermal resistance			300	K/W
Power dissipation	$T_{amb} = 70\text{ }^{\circ}\text{C}$	P_{diss}	100	mW
COUPLER				
Isolation test voltage between emitter and detector	$t = 1\text{ s}$	V_{ISO}	5300	V_{RMS}
Pollution degree (DIN VDE 0109)			2	
Isolation resistance	$V_{IO} = 500\text{ V}$, $T_{amb} = 25\text{ }^{\circ}\text{C}$	R_{IO}	$\geq 10^{12}$	Ω
	$V_{IO} = 500\text{ V}$, $T_{amb} = 100\text{ }^{\circ}\text{C}$	R_{IO}	$\geq 10^{11}$	Ω
Storage temperature range		T_{stg}	- 55 to + 125	$^{\circ}\text{C}$
Ambient temperature range		T_{amb}	- 55 to + 100	$^{\circ}\text{C}$
Soldering temperature ⁽¹⁾	max. $\leq 10\text{ s}$, dip soldering $\geq 0.5\text{ mm}$ from case bottom	T_{sld}	260	$^{\circ}\text{C}$

Notes

- Stresses in excess of the absolute maximum ratings can cause permanent damage to the device. Functional operation of the device is not implied at these or any other conditions in excess of those given in the operational sections of this document. Exposure to absolute maximum ratings for extended periods of the time can adversely affect reliability.
- ⁽¹⁾ Refer to reflow profile for soldering conditions for surface mounted devices (SMD). Refer to wave profile for soldering conditions for through hole devices (DIP).

ELECTRICAL CHARACTERISTICS ($T_{amb} = 25\text{ }^{\circ}\text{C}$, unless otherwise specified)							
PARAMETER	TEST CONDITION	PART	SYMBOL	MIN.	TYP.	MAX.	UNIT
INPUT							
Forward voltage	$I_F = 16\text{ mA}$		V_F		1.33	1.9	V
Breakdown voltage	$I_R = 10\text{ }\mu\text{A}$		V_{BR}	5			V
Reverse current	$V_R = 5\text{ V}$		I_R		0.5	10	μA
Capacitance	$V_R = 0\text{ V}$, $f = 1\text{ MHz}$		C_O		30		pF
Temperature coefficient, forward voltage	$I_F = 16\text{ mA}$		$\Delta V_F/\Delta T_A$		- 1.7		mV/ $^{\circ}\text{C}$
OUTPUT							
Logic low supply current	$I_F = 16\text{ mA}$, $V_O = \text{open}$, $V_{CC} = 15\text{ V}$		I_{CCL}		150		μA
Logic high supply current	$I_F = 0\text{ mA}$, $V_O = \text{open}$, $V_{CC} = 15\text{ V}$		I_{CCH}		0.01	1	μA
Output voltage, output low	$I_F = 16\text{ mA}$, $I_O = 1.1\text{ mA}$, $V_{CC} = 4.5\text{ V}$	6N135	V_{OL}		0.1	0.4	V
	$I_F = 16\text{ mA}$, $I_O = 2.4\text{ mA}$, $V_{CC} = 4.5\text{ V}$	6N136	V_{OL}		0.1	0.4	V
Output current, output high	$I_F = 0\text{ mA}$, $V_O = V_{CC} = 5.5\text{ V}$		I_{OH}		3	500	nA
	$I_F = 0\text{ mA}$, $V_O = V_{CC} = 15\text{ V}$		I_{OH}		0.01	1	μA
COUPLER							
Capacitance (input to output)	$f = 1\text{ MHz}$		C_{IO}		0.6		pF

Note

- Minimum and maximum values are testing requirements. Typical values are characteristics of the device and are the result of engineering evaluation. Typical values are for information only and are not part of the testing requirements.



CURRENT TRANSFER RATIO ($T_{amb} = 25\text{ }^{\circ}\text{C}$, unless otherwise specified)							
PARAMETER	TEST CONDITION	PART	SYMBOL	MIN.	TYP.	MAX.	UNIT
Current transfer ratio	$I_F = 16\text{ mA}$, $V_O = 0.4\text{ V}$, $V_{CC} = 4.5\text{ V}$	6N135	CTR	7	16		%
		6N136	CTR	19	35		%
	$I_F = 16\text{ mA}$, $V_O = 0.5\text{ V}$, $V_{CC} = 4.5\text{ V}$	6N135	CTR	5			%
		6N136	CTR	15			%

SWITCHING CHARACTERISTICS ($T_{amb} = 25\text{ }^{\circ}\text{C}$, unless otherwise specified)							
PARAMETER	TEST CONDITION	PART	SYMBOL	MIN.	TYP.	MAX.	UNIT
High to low	$I_F = 16\text{ mA}$, $V_{CC} = 5\text{ V}$, $R_L = 4.1\text{ k}\Omega$	6N135	t_{PHL}		0.3	1.5	μs
	$I_F = 16\text{ mA}$, $V_{CC} = 5\text{ V}$, $R_L = 1.9\text{ k}\Omega$	6N136	t_{PHL}		0.2	0.8	μs
Low to high	$I_F = 16\text{ mA}$, $V_{CC} = 5\text{ V}$, $R_L = 4.1\text{ k}\Omega$	6N135	t_{PLH}		0.3	1.5	μs
	$I_F = 16\text{ mA}$, $V_{CC} = 5\text{ V}$, $R_L = 1.9\text{ k}\Omega$	6N136	t_{PLH}		0.2	0.8	μs

COMMON MODE TRANSIENT IMMUNITY ($T_{amb} = 25\text{ }^{\circ}\text{C}$, unless otherwise specified)							
PARAMETER	TEST CONDITION	PART	SYMBOL	MIN.	TYP.	MAX.	UNIT
High	$I_F = 0\text{ mA}$, $V_{CM} = 10\text{ V}_{P-P}$, $V_{CC} = 5\text{ V}$, $R_L = 4.1\text{ k}\Omega$	6N135	$ C_{MH} $		1000		$\text{V}/\mu\text{s}$
	$I_F = 0\text{ mA}$, $V_{CM} = 10\text{ V}_{P-P}$, $V_{CC} = 5\text{ V}$, $R_L = 1.9\text{ k}\Omega$	6N136	$ C_{MH} $		1000		$\text{V}/\mu\text{s}$
Low	$I_F = 16\text{ mA}$, $V_{CM} = 10\text{ V}_{P-P}$, $V_{CC} = 5\text{ V}$, $R_L = 4.1\text{ k}\Omega$	6N135	$ C_{ML} $		1000		$\text{V}/\mu\text{s}$
	$I_F = 16\text{ mA}$, $V_{CM} = 10\text{ V}_{P-P}$, $V_{CC} = 5\text{ V}$, $R_L = 1.9\text{ k}\Omega$	6N136	$ C_{ML} $		1000		$\text{V}/\mu\text{s}$

SAFETY AND INSULATION RATINGS							
PARAMETER	TEST CONDITION	SYMBOL	MIN.	TYP.	MAX.	UNIT	
Climatic classification (according to IEC 68 part 1)				55/100/21			
Comparative tracking index		CTI	175		399		
V_{IOTM}			8000			V	
V_{IORM}			890			V	
P_{SO}					500	mW	
I_{SI}					300	mA	
T_{SI}					175	$^{\circ}\text{C}$	
Creepage distance	Standard DIP-8		7			mm	
Clearance distance	Standard DIP-8		7			mm	
Creepage distance	400 mil DIP-8		8			mm	
Clearance distance	400 mil DIP-8		8			mm	

Note

- According to DIN EN 60747-5-2 (VDE 0884), this optocoupler is suitable for "safe electrical insulation" only within the safety ratings. Compliance with the safety ratings shall be ensured by means of protective circuits.

TYPICAL CHARACTERISTICS ($T_{amb} = 25\text{ }^{\circ}\text{C}$, unless otherwise specified)

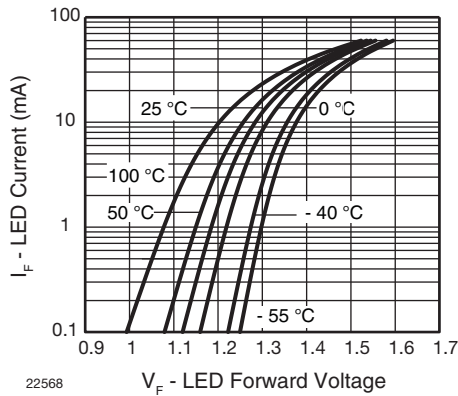

Fig. 1 - LED Forward Current vs. Forward Voltage

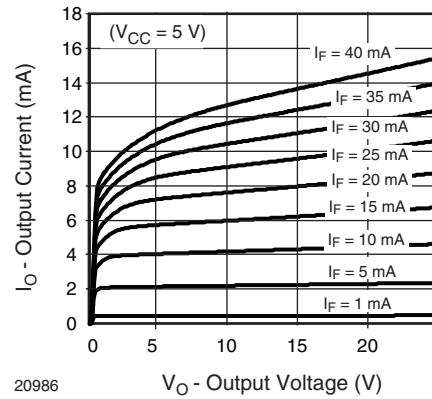

Fig. 4 - Output Current vs. Output Voltage

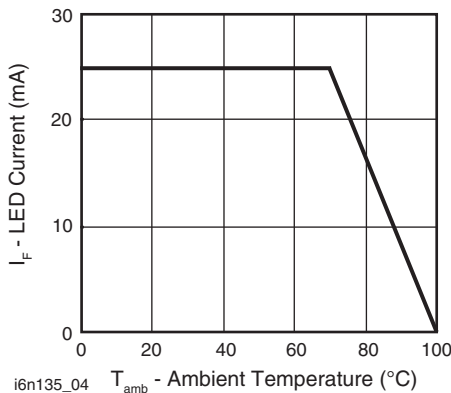

Fig. 2 - Permissible Forward LED Current vs. Temperature

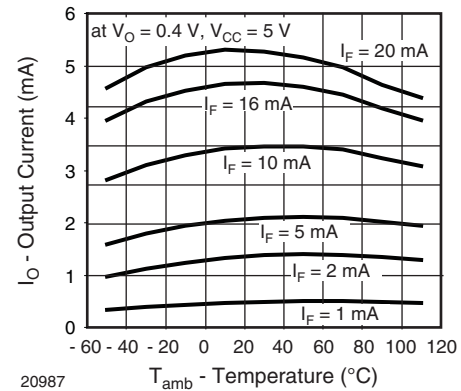

Fig. 5 - Output Current vs. Temperature

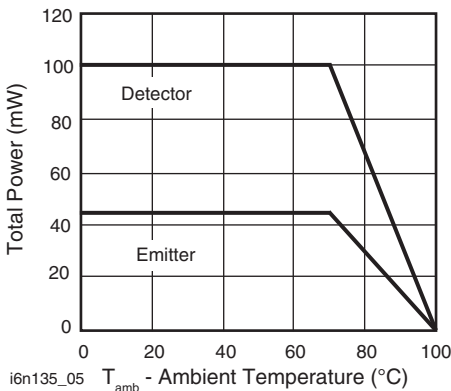

Fig. 3 - Permissible Power Dissipation vs. Temperature

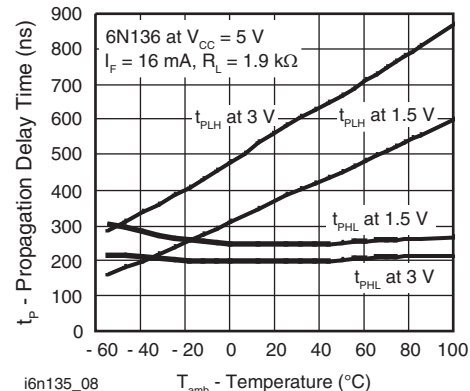

Fig. 6 - Propagation Delay vs. Ambient Temperature

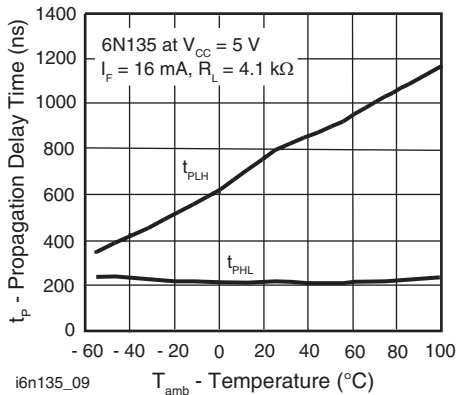

Fig. 7 - Propagation Delay vs. Ambient Temperature

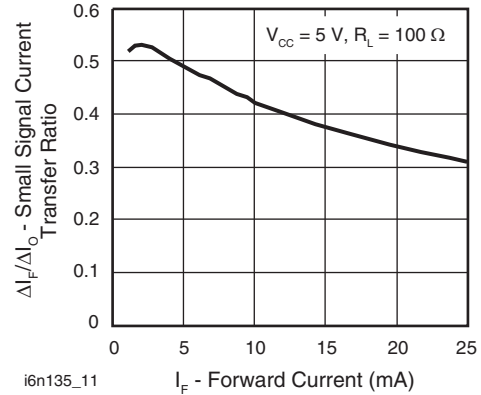

Fig. 9 - Small Signal Current Transfer Ratio vs. Quiescent Input Current

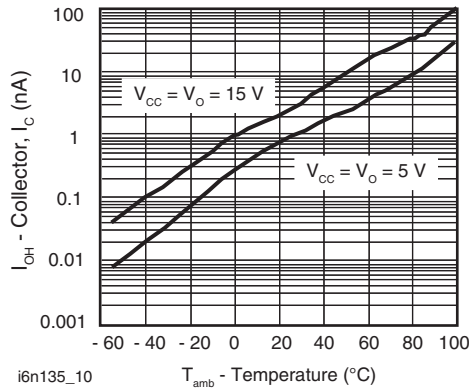

Fig. 8 - Logic High Output Current vs. Temperature

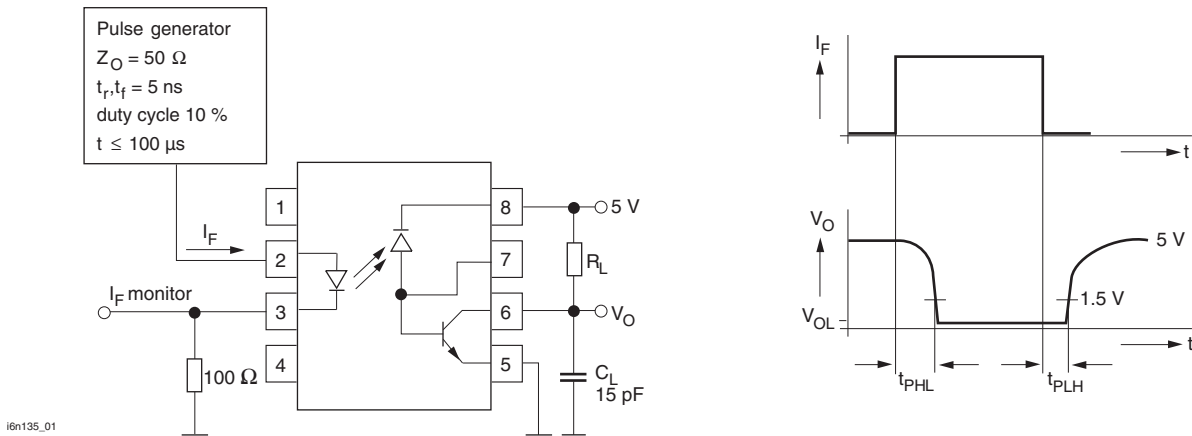

Fig. 10 - Switching Times

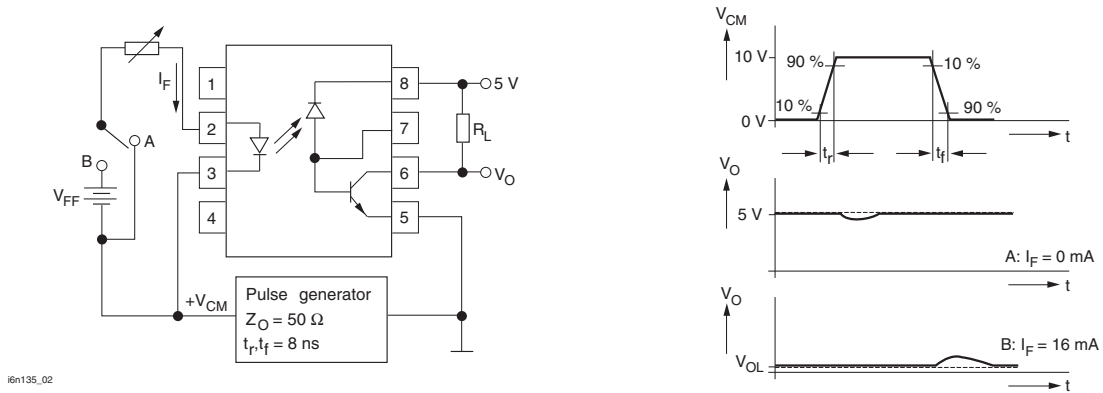
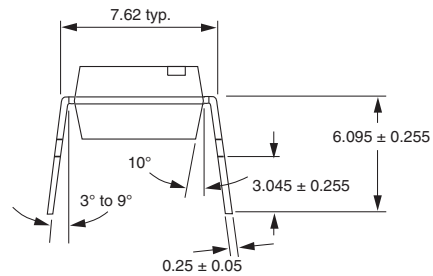
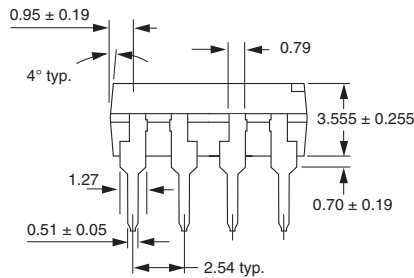
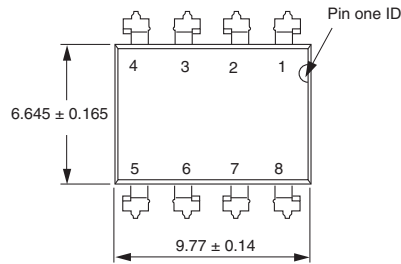
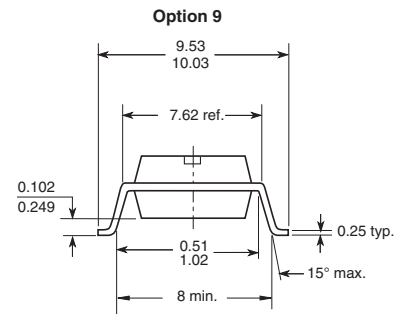
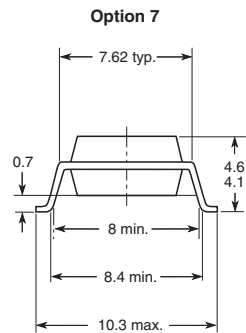
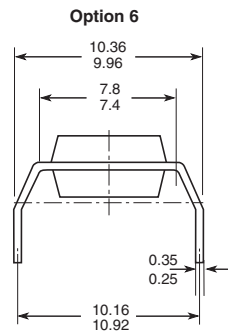

Fig. 11 - Common-Mode Interference Immunity

PACKAGE DIMENSIONS in millimeters



i178006



18450

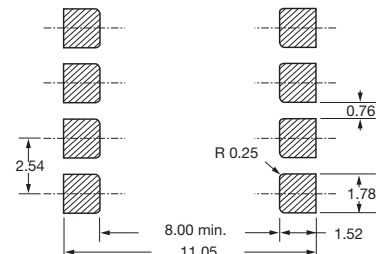
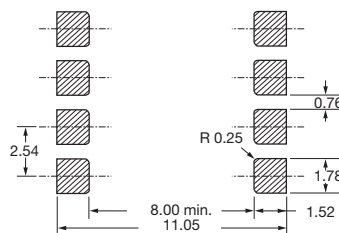



PACKAGE MARKING



Notes

- Only options 1, and 7 are reflected in the package marking.
- The VDE logo is only marked on option 1 parts.
- Tape and reel suffix (T) is not part of the package marking.



Disclaimer

ALL PRODUCT, PRODUCT SPECIFICATIONS AND DATA ARE SUBJECT TO CHANGE WITHOUT NOTICE TO IMPROVE RELIABILITY, FUNCTION OR DESIGN OR OTHERWISE.

Vishay Intertechnology, Inc., its affiliates, agents, and employees, and all persons acting on its or their behalf (collectively, "Vishay"), disclaim any and all liability for any errors, inaccuracies or incompleteness contained in any datasheet or in any other disclosure relating to any product.

Vishay makes no warranty, representation or guarantee regarding the suitability of the products for any particular purpose or the continuing production of any product. To the maximum extent permitted by applicable law, Vishay disclaims (i) any and all liability arising out of the application or use of any product, (ii) any and all liability, including without limitation special, consequential or incidental damages, and (iii) any and all implied warranties, including warranties of fitness for particular purpose, non-infringement and merchantability.

Statements regarding the suitability of products for certain types of applications are based on Vishay's knowledge of typical requirements that are often placed on Vishay products in generic applications. Such statements are not binding statements about the suitability of products for a particular application. It is the customer's responsibility to validate that a particular product with the properties described in the product specification is suitable for use in a particular application. Parameters provided in datasheets and/or specifications may vary in different applications and performance may vary over time. All operating parameters, including typical parameters, must be validated for each customer application by the customer's technical experts. Product specifications do not expand or otherwise modify Vishay's terms and conditions of purchase, including but not limited to the warranty expressed therein.

Except as expressly indicated in writing, Vishay products are not designed for use in medical, life-saving, or life-sustaining applications or for any other application in which the failure of the Vishay product could result in personal injury or death. Customers using or selling Vishay products not expressly indicated for use in such applications do so at their own risk. Please contact authorized Vishay personnel to obtain written terms and conditions regarding products designed for such applications.

No license, express or implied, by estoppel or otherwise, to any intellectual property rights is granted by this document or by any conduct of Vishay. Product names and markings noted herein may be trademarks of their respective owners.

Material Category Policy

Vishay Intertechnology, Inc. hereby certifies that all its products that are identified as RoHS-Compliant fulfill the definitions and restrictions defined under Directive 2011/65/EU of The European Parliament and of the Council of June 8, 2011 on the restriction of the use of certain hazardous substances in electrical and electronic equipment (EEE) - recast, unless otherwise specified as non-compliant.

Please note that some Vishay documentation may still make reference to RoHS Directive 2002/95/EC. We confirm that all the products identified as being compliant to Directive 2002/95/EC conform to Directive 2011/65/EU.

Vishay Intertechnology, Inc. hereby certifies that all its products that are identified as Halogen-Free follow Halogen-Free requirements as per JEDEC JS709A standards. Please note that some Vishay documentation may still make reference to the IEC 61249-2-21 definition. We confirm that all the products identified as being compliant to IEC 61249-2-21 conform to JEDEC JS709A standards.