

# HLMP-EGxx, HLMP-ELxx and HLMP-EHxx T-1¾ (5mm) Extra High Brightness AlInGaP LED Lamps



## Data Sheet



### Description

These Precision Optical Performance AlInGaP LEDs provide superior light output for excellent readability in sunlight and are extremely reliable. AlInGaP LED technology provides extremely stable light output over long periods of time. Precision Optical Performance lamps utilize the aluminum indium gallium phosphide (AlInGaP) technology.

These LED lamps are untinted, T-1¾ packages incorporating second generation optics producing well defined spatial radiation patterns at specific viewing cone angles.

These lamps are made with an advanced optical grade epoxy offering superior high temperature and high moisture resistance performance in outdoor signal and sign application. The maximum LED junction temperature limit of +130°C enables high temperature operation in bright sunlight conditions. The epoxy contains both uv-a and uv-b inhibitors to reduce the effects of long term exposure to direct sunlight.

### Benefits

- Superior performance for outdoor environments
- Suitable for auto-insertion onto PC board

### Features

- Viewing angle: 15°, 23°, 30°
- High luminous output
- Colors:
  - 590nm Amber
  - 615nm Red-Orange
  - 626nm Red
- Package options:
  - With or without lead standoff
- Superior resistance to moisture
- Untinted non-diffused for 15° and 30° lamps
- Untinted diffused for 23° lamps

### Applications

- Traffic management:
  - Traffic signals
  - Pedestrian signals
  - Work zone warning lights
  - Variable message signs
- Commercial outdoor advertising
  - Signs
  - Marquees

# Package Dimension

A

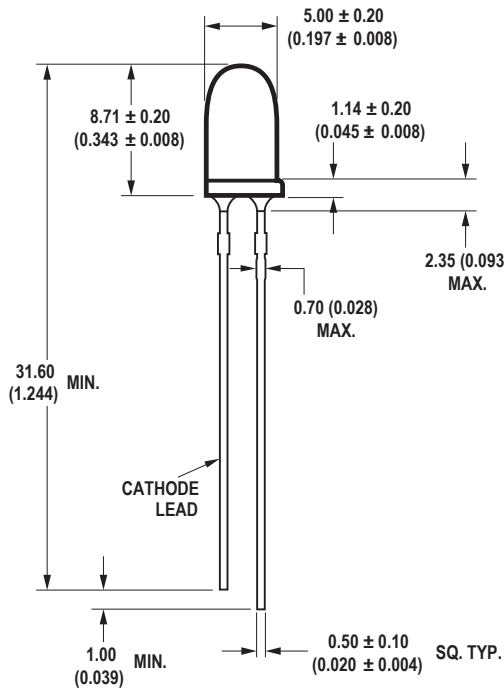

B

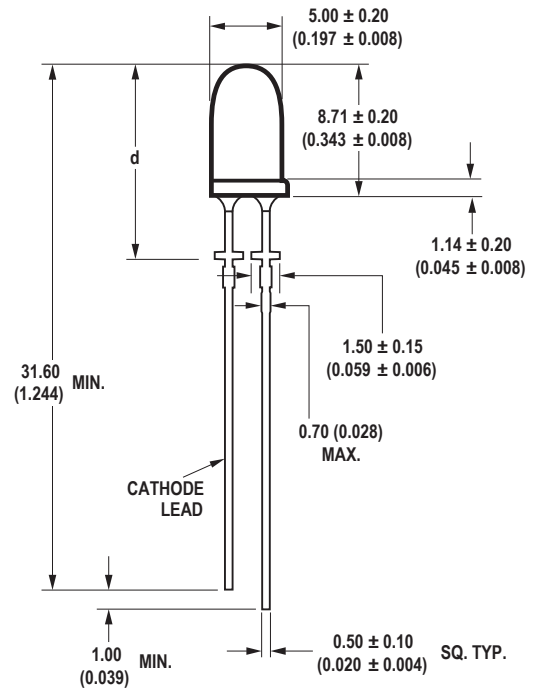

**NOTES:**

1. ALL DIMENSIONS ARE IN MILLIMETERS (INCHES).
2. TAPERS SHOWN AT TOP OF LEADS (BOTTOM OF LAMP PACKAGE) INDICATE AN EPOXY MENISCUS THAT MAY EXTEND ABOUT 1 mm (0.040 in.) DOWN THE LEADS.
3. RECOMMENDED PC BOARD HOLE DIAMETERS:
  - LAMP PACKAGE A WITHOUT STAND-OFFS: FLUSH MOUNTING AT BASE OF LAMP PACKAGE =  $1.143/1.067$  ( $0.044/0.042$ ).
  - LAMP PACKAGE B WITH STAND-OFFS: MOUNTING AT LEAD STAND-OFFS =  $0.965/0.889$  ( $0.038/0.035$ ).
4. FOR DOME HEIGHTS ABOVE LEAD STAND-OFF SEATING PLANE,  $d$ , LAMP PACKAGE B, SEE TABLE.
5. FOR IDENTIFICATION OF POLARITY AFTER THE LEADS ARE TRIMMED OFF, PLEASE REFER TO THE ILLUSTRATION BELOW:

| PART NO.  | $d$                                       |
|-----------|---|
| HLMP-XX13 | $12.42 \pm 0.25$<br>( $0.489 \pm 0.010$ ) |
| HLMP-XX23 | $11.59 \pm 0.25$<br>( $0.446 \pm 0.010$ ) |
| HLMP-XX37 | $11.96 \pm 0.25$<br>( $0.471 \pm 0.010$ ) |

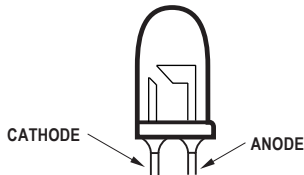

7. MAJOR HEAT PATH IS THROUGH THE ANODE LEAD

## Device Selection Guide

| Typical Viewing Angle $2\theta_{1/2}$ (Deg) <sup>[4]</sup> | Color and Dominant Wavelength (nm), Typ. <sup>[3]</sup> | Lamps without Standoffs on Leads (Outline Drawing A) | Lamps with Standoffs on Leads (Outline Drawing B) | Luminous Intensity $I_v$ (mcd) <sup>[1,2,5]</sup> @ 20mA |       |
|--|---|--|---|--|-------|
|  |   |  |   | Min.   | Max.  |
| 15°  | Amber 590   | HLMP-EL12-VY0DD                                      | HLMP-EL13-VY0DD                                   | 4200   | 12000 |
|  |   | HLMP-EL12-XYKDD                                      |   | 7200   | 12000 |
|  | Red-Orange 615  | HLMP-EH12-VY0DD                                      | HLMP-EH13-VY0DD                                   | 4200   | 12000 |
|  | Red 626   | HLMP-EG12-VY0DD                                      | HLMP-EG13-VY0DD                                   | 4200   | 12000 |
|  |   | HLMP-EG12-WX0DD                                      |   | 5500   | 9300  |
| 23°  | Amber 590   | HLMP-EL22-UXKDD                                      | HLMP-EL23-UXKDD                                   | 3200   | 9300  |
|  |   | HLMP-EL22-UX0DD                                      | HLMP-EL23-UX0DD                                   | 3200   | 9300  |
|  |   | HLMP-EL22-VWKDD                                      |   | 4200   | 7200  |
|  | Red-Orange 615  | HLMP-EH22-TW0DD                                      | HLMP-EH23-TW0DD                                   | 2500   | 7200  |
|  | Red 626   | HLMP-EG22-UX0DD                                      | HLMP-EG23-UX0DD                                   | 3200   | 9300  |
|  |   | HLMP-EG22-VW0DD                                      |   | 4200   | 7200  |
| 30°  | Amber 590   | HLMP-EL35-TW0DD                                      | HLMP-EL37-TW0DD                                   | 2500   | 7200  |
|  |   | HLMP-EL35-TWKDD                                      | HLMP-EL37-TWKDD                                   | 2500   | 7200  |
|  |   | HLMP-EL35-UVKDD                                      |   | 3200   | 5500  |
|  | Red-Orange 615  | HLMP-EH35-SV0DD                                      | HLMP-EH37-SV0DD                                   | 1900   | 5500  |
|  | Red 626   | HLMP-EG35-TW0DD                                      | HLMP-EG37-TW0DD                                   | 2500   | 7200  |
|  |   | HLMP-EG35-UV0DD                                      |   | 3200   | 5500  |

### Notes:

1. The luminous intensity is measured on the mechanical axis of the lamp package.
2. The optical axis is closely aligned with the package mechanical axis.
3. Dominant wavelength,  $\lambda_d$ , is derived from the CIE Chromaticity Diagram and represents the color of the lamp.
4.  $\theta_{1/2}$  is the off-axis angle where the luminous intensity is half the on-axis intensity.
5. Tolerance for each intensity bin limit is  $\pm 15\%$ .

## Part Numbering System

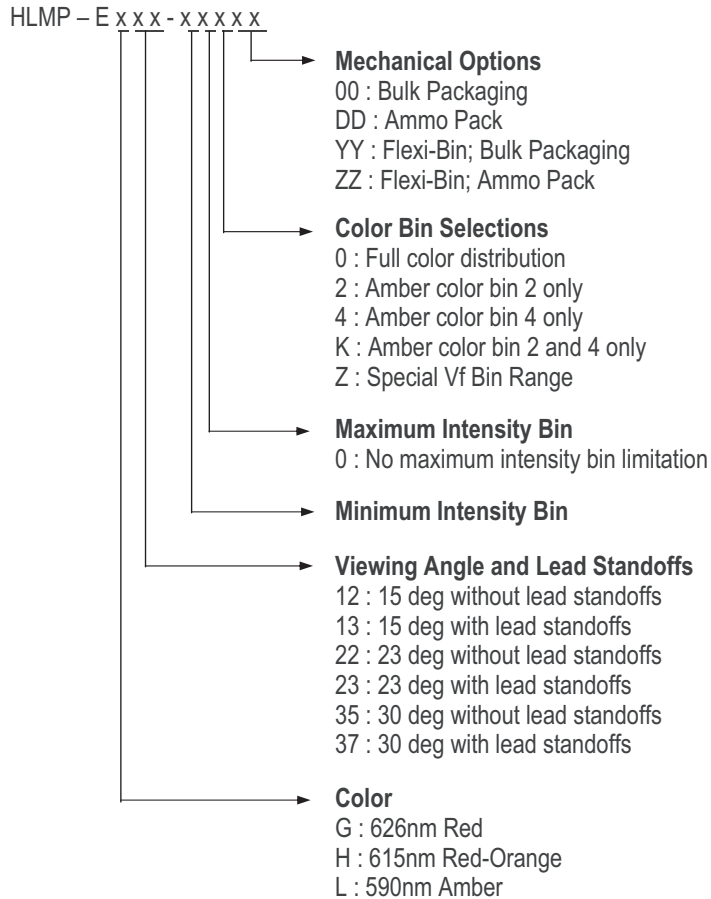

Note: Please refer to AB 5337 for complete information on part numbering system.

## Absolute Maximum Ratings at $T_A = 25^\circ\text{C}$

|   |   |
|---|---|
| DC Forward Current <sup>[1]</sup>           | 50 mA                                       |
| Peak Pulsed Forward Current                 | 100 mA                                      |
| Average Forward Current                     | 30 mA                                       |
| Reverse Voltage ( $I_r = 100 \mu\text{A}$ ) | 5 V   |
| Operating Temperature                       | $-40^\circ\text{C}$ to $+100^\circ\text{C}$ |
| Storage Temperature                         | $-40^\circ\text{C}$ to $+100^\circ\text{C}$ |

Notes:

1. Derate linearly as shown in Figure 4.

## Electrical/ Optical Characteristics at $T_A = 25^\circ\text{C}$

| Parameter                          | Symbol                   | Minimum | Average | Maximum | Units              | Test Condition                             |
|------------------------------------|--------------------------|---------|---------|---------|--------------------|--|
| Forward Voltage                    |                          |         |         |         |                    | $I_F = 20\text{mA}$                        |
| Amber                              |                          |         | 2.20    |         |                    |  |
| Red                                | $V_F$                    | 1.80    | 2.10    | 2.40    | V                  |  |
| Red-Orange                         |                          |         | 2.00    |         |                    |  |
| Peak Wavelength                    |                          |         |         |         |                    | $I_F = 20\text{mA}$                        |
| Amber                              |                          |         | 590     |         |                    |  |
| Red                                | $\lambda_{\text{PEAK}}$  |         | 626     |         | nm                 |  |
| Red-Orange                         |                          |         | 615     |         |                    |  |
| Dominant Wavelength <sup>[1]</sup> |                          |         |         |         |                    | $I_F = 20\text{mA}$                        |
| Amber                              |                          | 584.5   |         | 594.5   |                    |  |
| Red                                | $\lambda_d$              | 620.0   |         | 630.0   | nm                 |  |
| Red-Orange                         |                          | 612.0   |         | 621.7   |                    |  |
| Reverse Voltage                    | $V_R$                    | 5       |         |         | V                  | $I_R = 100\mu\text{A}$                     |
| Spectral Halfwidth                 | $\Delta\lambda_{1/2}$    |         | 17      |         | nm                 | $I_F = 20\text{mA}$                        |
| Capacitance                        | C                        |         | 40      |         | pF                 | $V_F = 0, f = 1\text{MHz}$                 |
| Thermal Resistance                 | $R\theta_{\text{J-PIN}}$ |         | 240     |         | $^\circ\text{C/W}$ | LED Junction-to-Anode Lead                 |
| Luminous Efficacy <sup>[2]</sup>   |                          |         |         |         |                    | Emitted Luminous Flux/Emitted Radiant Flux |
| Amber                              |                          |         | 480     |         |                    |  |
| Red                                | $\eta_V$                 |         | 150     |         | lm/W               |  |
| Red-Orange                         |                          |         | 260     |         |                    |  |
| Luminous Flux                      | $\phi_V$                 |         | 1300    |         | mlm                | $I_F = 20\text{mA}$                        |
| Luminous Efficiency <sup>[3]</sup> | $\eta_e$                 |         | 30      |         | lm/W               | Emitted Luminous Flux/ Electrical Power    |

Notes:

1. The dominant wavelength,  $\lambda_d$  is derived from the CIE Chromaticity Diagram referenced to Illuminant E. Tolerance for each color of dominant wavelength is  $\pm 0.5\text{nm}$ .
2. The radiant intensity,  $I_e$  in watts per steradian, maybe found from the equation  $I_e = I_v / \eta_V$  where  $I_v$  is the luminous intensity in candela and  $\eta_V$  is the luminous efficacy in lumens/watt.
3.  $\eta_e = \phi_V / I_F \times V_F$ , where  $\phi_V$  is the emitted luminous flux,  $I_F$  is electrical forward current and  $V_F$  is the forward voltage.

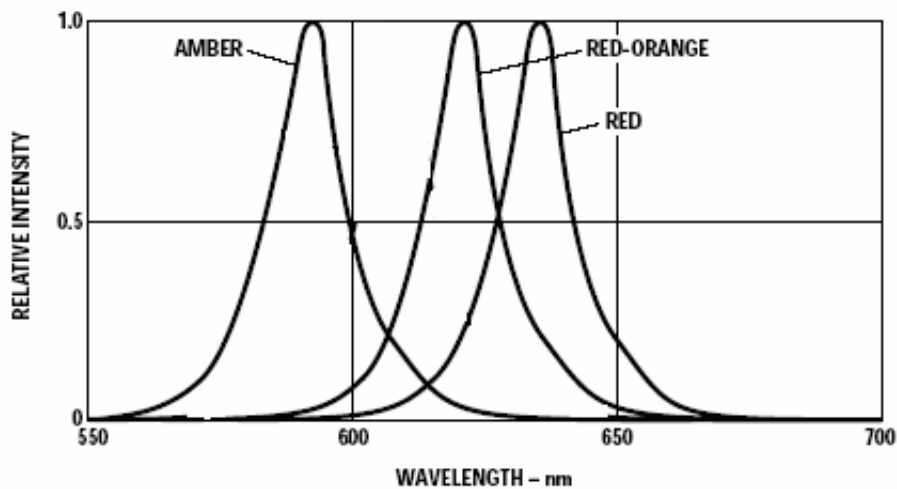

Figure 1. Relative intensity vs. peak wavelength

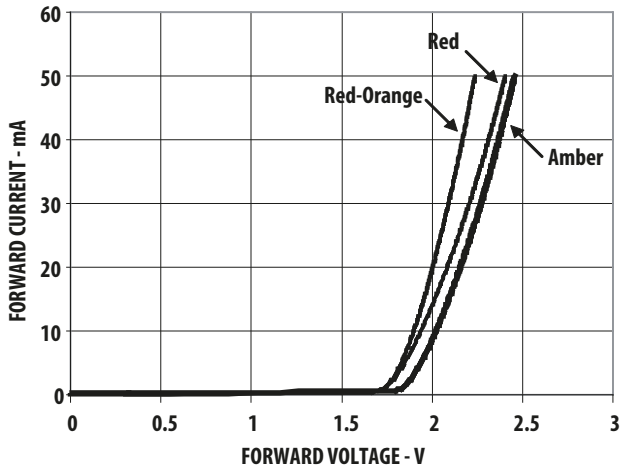

Figure 2. Forward current vs. forward voltage

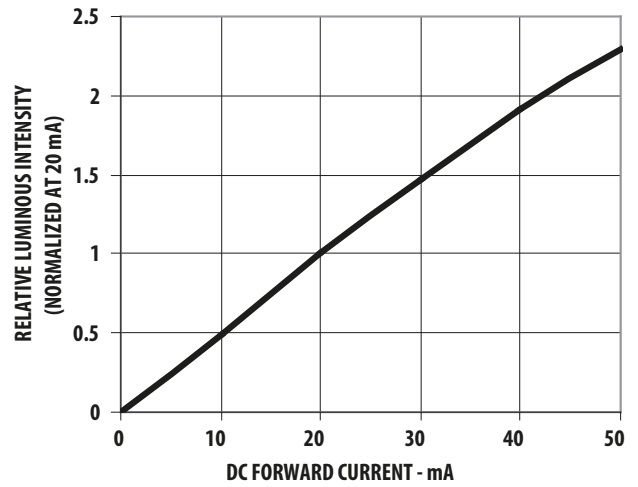

Figure 3. Relative luminous intensity vs. forward current

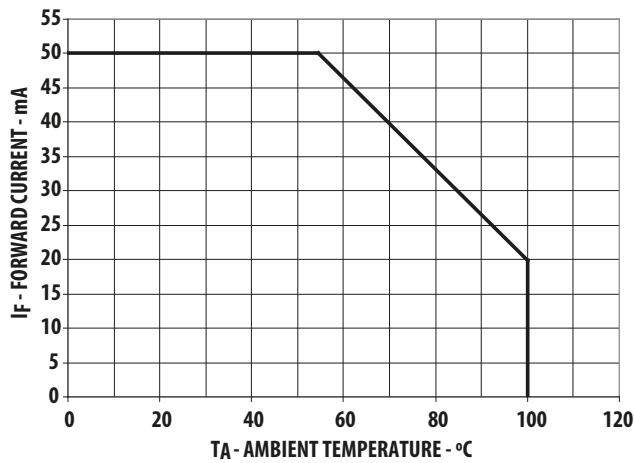

Figure 4. Maximum forward current vs. ambient temperature

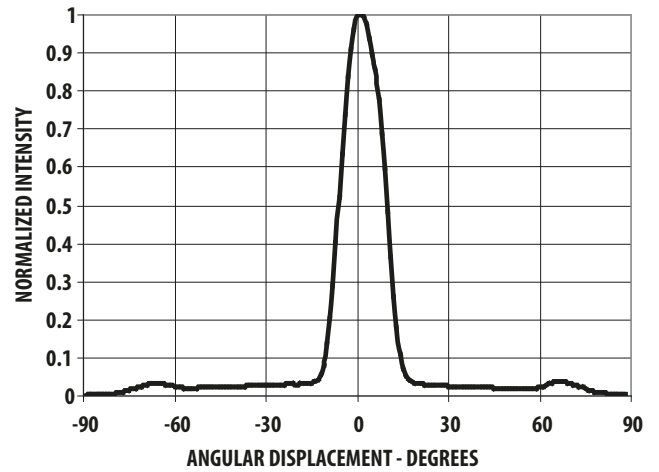

Figure 5. Representative spatial radiation pattern for 15° viewing angle lamps

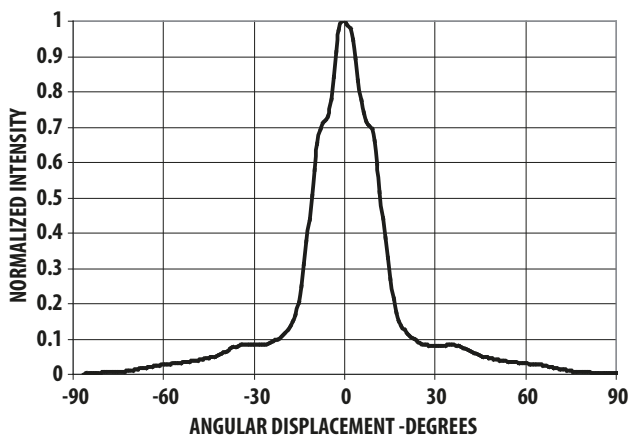

Figure 6. Representative spatial radiation pattern for 23° viewing angle lamps

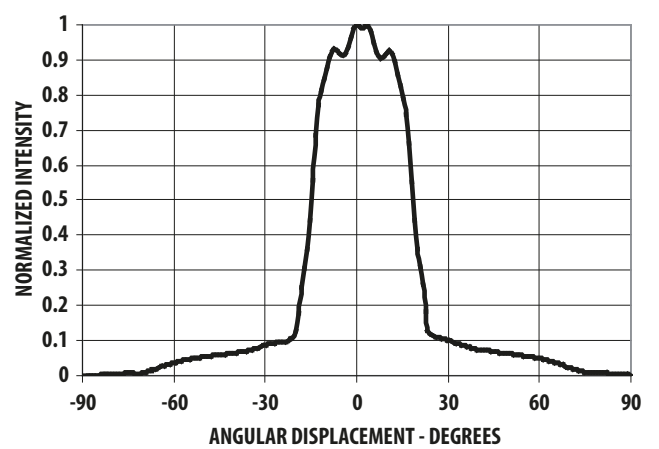

Figure 7. Representative spatial radiation pattern for 30° viewing angle lamps

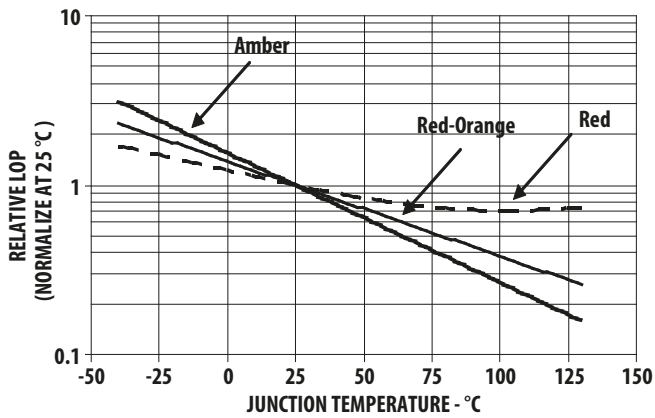

Figure 8. Relative light output vs. junction temperature

**Intensity Bin Limits (mcd at 20mA)**

| Bin Name | Minimum | Maximum |
|----------|---------|---------|
| R        | 1500    | 1900    |
| S        | 1900    | 2500    |
| T        | 2500    | 3200    |
| U        | 3200    | 4200    |
| V        | 4200    | 5500    |
| W        | 5500    | 7200    |
| X        | 7200    | 9300    |
| Y        | 9300    | 12000   |
| Z        | 12000   | 16000   |
| 1        | 16000   | 21000   |
| 2        | 21000   | 27000   |

Tolerance for each bin limit is ± 15%

**Forward Voltage Bin Limits (V at 20mA)**

| Bin Name | Minimum | Maximum |
|----------|---------|---------|
| VD       | 1.8     | 2.0     |
| VA       | 2.0     | 2.2     |
| VB       | 2.2     | 2.4     |

Tolerance for each bin limit is ± 0.05V

**Amber Color Bin Limits (nm at 20mA)**

| Bin Name | Minimum | Maximum |
|----------|---------|---------|
| 1        | 584.5   | 587.0   |
| 2        | 587.0   | 589.5   |
| 4        | 589.5   | 592.0   |
| 6        | 592.0   | 594.5   |

Tolerance for each bin limit is ± 0.5nm

Note: Bin categories are established for classification of products. Products may not be available in all bin categories.

## Precautions:

### Lead Forming:

- The leads of an LED lamp may be preformed or cut to length prior to insertion and soldering on PC board.
- For better control, it is recommended to use proper tool to precisely form and cut the leads to applicable length rather than doing it manually.
- If manual lead cutting is necessary, cut the leads after the soldering process. The solder connection forms a mechanical ground which prevents mechanical stress due to lead cutting from traveling into LED package. This is highly recommended for hand solder operation, as the excess lead length also acts as small heat sink.

### Soldering and Handling:

- Care must be taken during PCB assembly and soldering process to prevent damage to the LED component.
- LED component may be effectively hand soldered to PCB. However, it is only recommended under unavoidable circumstances such as rework. The closest manual soldering distance of the soldering heat source (soldering iron's tip) to the body is 1.59mm. Soldering the LED using soldering iron tip closer than 1.59mm might damage the LED.

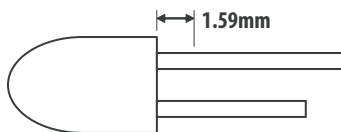

- ESD precaution must be properly applied on the soldering station and personnel to prevent ESD damage to the LED component that is ESD sensitive. Do refer to Avago application note AN 1142 for details. The soldering iron used should have grounded tip to ensure electrostatic charge is properly grounded.
- Recommended soldering condition:

|                      | Wave Soldering [1, 2] | Manual Solder Dipping |
|----------------------|-----------------------|-----------------------|
| Pre-heat temperature | 105 °C Max.           | -                     |
| Preheat time         | 60 sec Max            | -                     |
| Peak temperature     | 250 °C Max.           | 260 °C Max.           |
| Dwell time           | 3 sec Max.            | 5 sec Max             |

#### Note:

1. Above conditions refers to measurement with thermocouple mounted at the bottom of PCB.
  2. It is recommended to use only bottom preheaters in order to reduce thermal stress experienced by LED.
- Wave soldering parameters must be set and maintained according to the recommended temperature and dwell time. Customer is advised to perform daily check on the soldering profile to ensure that it is always conforming to recommended soldering conditions.

#### Note:

1. PCB with different size and design (component density) will have different heat mass (heat capacity). This might cause a change in temperature experienced by the board if same wave soldering setting is used. So, it is recommended to re-calibrate the soldering profile again before loading a new type of PCB.
2. Avago Technologies' high brightness LED are using high efficiency LED die with single wire bond as shown below. Customer is advised to take extra precaution during wave soldering to ensure that the maximum wave temperature does not exceed 250°C and the solder contact time does not exceeding 3sec. Over-stressing the LED during soldering process might cause premature failure to the LED due to delamination.

### Avago Technologies LED configuration

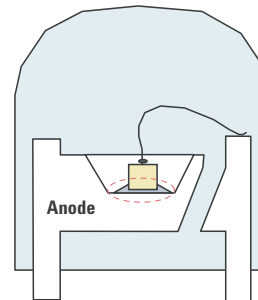

Note: Electrical connection between bottom surface of LED die and the lead frame is achieved through conductive paste.

- Any alignment fixture that is being applied during wave soldering should be loosely fitted and should not apply weight or force on LED. Non metal material is recommended as it will absorb less heat during wave soldering process.

Note: In order to further assist customer in designing jig accurately that fit Avago Technologies' product, 3D model of the product is available upon request.

- At elevated temperature, LED is more susceptible to mechanical stress. Therefore, PCB must allowed to cool down to room temperature prior to handling, which includes removal of alignment fixture or pallet.
- If PCB board contains both through hole (TH) LED and other surface mount components, it is recommended that surface mount components be soldered on the top side of the PCB. If surface mount need to be on the bottom side, these components should be soldered using reflow soldering prior to insertion the TH LED.
- Recommended PC board plated through holes (PTH) size for LED component leads.

| LED component lead size               | Diagonal                 | Plated through hole diameter             |
|---------------------------------------|--------------------------|--|
| 0.45 x 0.45 mm<br>(0.018x 0.018 inch) | 0.636 mm<br>(0.025 inch) | 0.98 to 1.08 mm<br>(0.039 to 0.043 inch) |
| 0.50 x 0.50 mm<br>(0.020x 0.020 inch) | 0.707 mm<br>(0.028 inch) | 1.05 to 1.15 mm<br>(0.041 to 0.045 inch) |

- Over-sizing the PTH can lead to twisted LED after clinching. On the other hand under sizing the PTH can cause difficulty inserting the TH LED



## Recommended Wave Soldering Profile

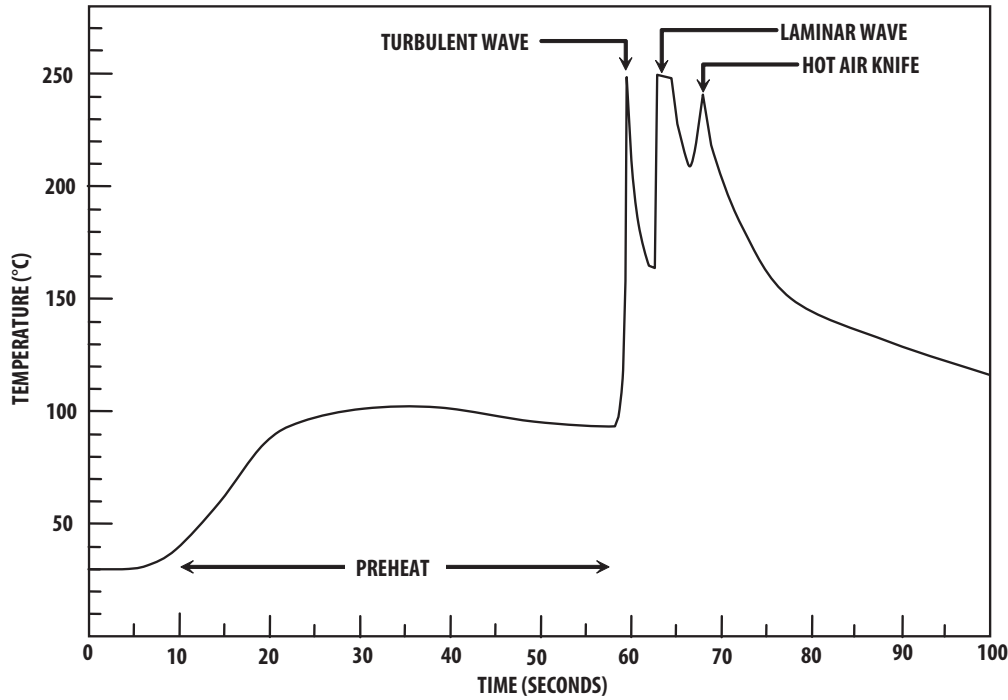

Recommended solder:  
Sn63 (Leaded solder alloy)  
SAC305 (Lead free solder alloy)

Flux: Rosin flux

Solder bath temperature:  
245°C ± 5°C (maximum peak  
temperature = 250°C)

Dwell time: 1.5 sec - 3.0 sec  
(maximum = 3sec)

Note: Allow for board to be  
sufficiently cooled to room  
temperature before exerting  
mechanical force.

Figure 9. Recommended Wave Soldering Profile

## Ammo Packs Drawing

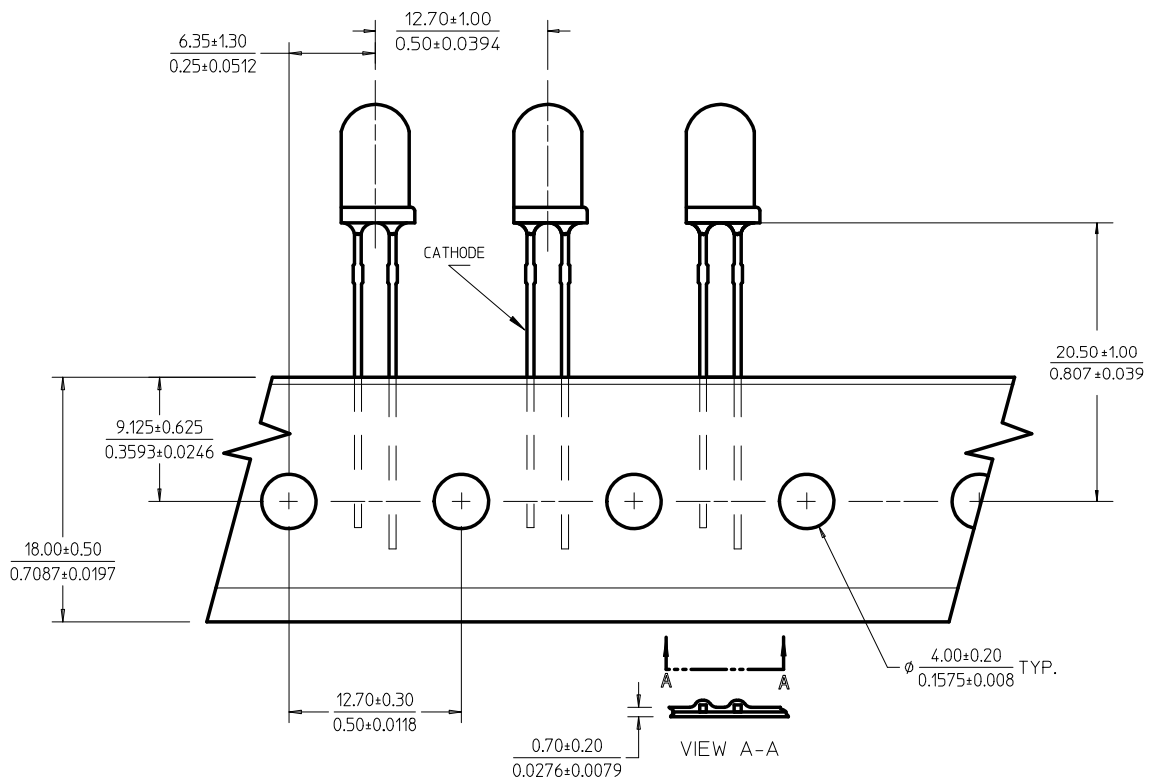

Note: The ammo-packs drawing is applicable for packaging option -DD & -ZZ and regardless standoff or non-standoff

Figure 10. Dimension for ammo pack

## Packaging Box for Ammo Packs

FROM LEFT SIDE OF BOX  
ADHESIVE TAPE MUST BE  
FACING UPWARDS.

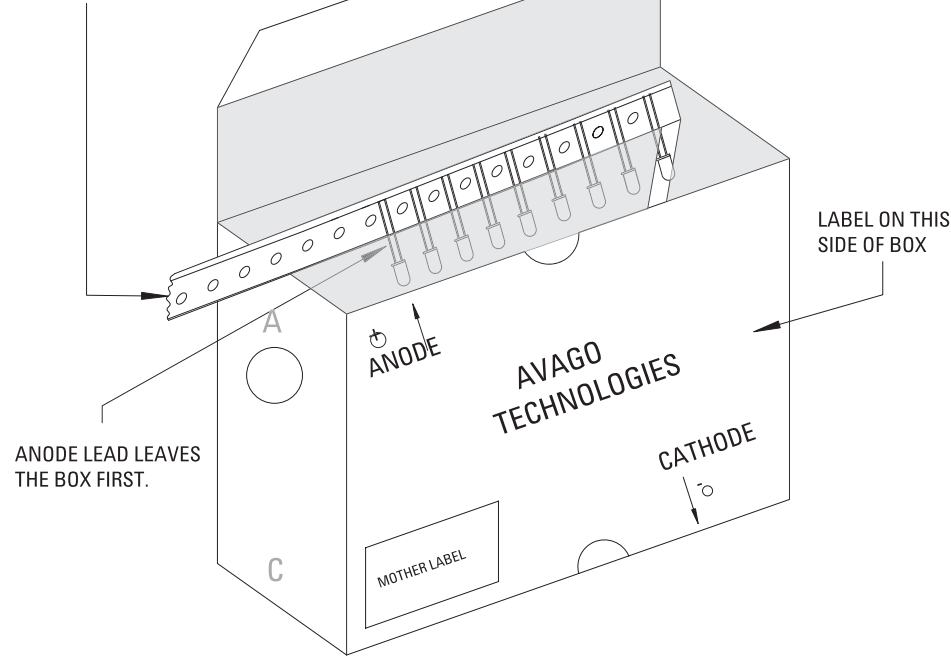

Note: The dimension for ammo pack is applicable for the device with standoff and without standoff.







Figure 11. The arrangement of unit in ammo pack

## Packaging Label:

(i) Avago Mother Label: (Available on packaging box of ammo pack and shipping box)

|  |   |
|--|---|
| (1P) Item: <b>Part Number</b><br>[Barcode]           | <b>AVAGO</b><br>TECHNOLOGIES<br>STANDARD LABEL LS0002<br>RoHS Compliant<br>e3 max temp 250C |
| (1T) Lot: <b>Lot Number</b><br>[Barcode]             | (Q) QTY: <b>Quantity</b><br>[Barcode]   |
| LPN:<br>[Barcode]                                    | CAT: <b>Intensity Bin</b><br>[Barcode]  |
| (9D)MFG Date: <b>Manufacturing Date</b><br>[Barcode] | BIN: <b>Refer to below information</b>  |
| <hr/>  |   |
| (P) Customer Item:<br>[Barcode]                      |   |
| (V) Vendor ID:<br>[Barcode]                          | (9D) Date Code: <b>Date Code</b><br>[Barcode]   |
| <hr/>  |   |
| DeptID:<br>[Barcode]                                 | Made In: <b>Country of Origin</b><br>[Barcode]  |

(ii) Avago Baby Label (Only available on bulk packaging)

|   |   |  |  |
|---|---|--|--|
| <br><b>Avago</b><br>TECHNOLOGIES     |   | RoHS Compliant<br>e3 max temp 250C   |  |
| <b>Lamps Baby Label</b>   |   |  |  |
| (1P) PART #: Part Number<br>         |   |  |  |
| (1T) LOT #: Lot Number<br>           |   |  |  |
| (9D)MFG DATE: Manufacturing Date<br> | QUANTITY: Packing Quantity<br> |  |  |
| C/O: Country of Origin  |   |  |  |
| Customer P/N:<br>                    |   | CAT: Intensity Bin<br>              |  |
| Supplier Code:<br>                   |   | BIN: Refer to below information<br> |  |
|   |   | DATECODE: Date Code<br>             |  |

**Acronyms and Definition:**

BIN:

(i) Color bin only or VF bin only

(Applicable for part number with color bins but without VF bin OR part number with VF bins and no color bin)

OR

(ii) Color bin incorporated with VF Bin

(Applicable for part number that have both color bin and VF bin)

Example:

(i) Color bin only or VF bin only

BIN: 2 (represent color bin 2 only)

BIN: VB (represent VF bin "VB" only)

(ii) Color bin incorporate with VF Bin

BIN: 2VB

└─┬─> VB: VF bin "VB"

└─┬─> 2: Color bin 2 only

**DISCLAIMER:** AVAGO'S PRODUCTS AND SOFTWARE ARE NOT SPECIFICALLY DESIGNED, MANUFACTURED OR AUTHORIZED FOR SALE AS PARTS, COMPONENTS OR ASSEMBLIES FOR THE PLANNING, CONSTRUCTION, MAINTENANCE OR DIRECT OPERATION OF A NUCLEAR FACILITY OR FOR USE IN MEDICAL DEVICES OR APPLICATIONS. CUSTOMER IS SOLELY RESPONSIBLE, AND WAIVES ALL RIGHTS TO MAKE CLAIMS AGAINST AVAGO OR ITS SUPPLIERS, FOR ALL LOSS, DAMAGE, EXPENSE OR LIABILITY IN CONNECTION WITH SUCH USE.

For product information and a complete list of distributors, please go to our web site: [www.avagotech.com](http://www.avagotech.com)

Avago, Avago Technologies, and the A logo are trademarks of Avago Technologies in the United States and other countries. Data subject to change. Copyright © 2005-2014 Avago Technologies. All rights reserved. AV02-0086EN - July 18, 2014

