

Data Sheet



Description

This high intensity blue and green LEDs are based on the most efficient and cost effective InGaN material technology. This LED lamps is untinted and non-diffused, T-1 3/4 packages incorporating second-generation optics producing well defined spatial radiation patterns at specific viewing cone angles.

These lamps are made with an advanced optical grade epoxy, offering superior temperature and moisture resistance in outdoor signal and sign applications. The package epoxy contains both UV-A and UV-B inhibitors to reduce the effects of long term exposure to direct sunlight.

Features

- Well defined spatial radiation pattern
- High luminous output
- Untinted, Non-diffused
- Viewing angle: 15°, 23° and 30°
- Standoff or non-standoff leads
- Superior resistance to moisture

Applications

- Traffic signals
- Commercial outdoor advertising
- Front panel backlighting
- Front panel indicator

Package Dimensions

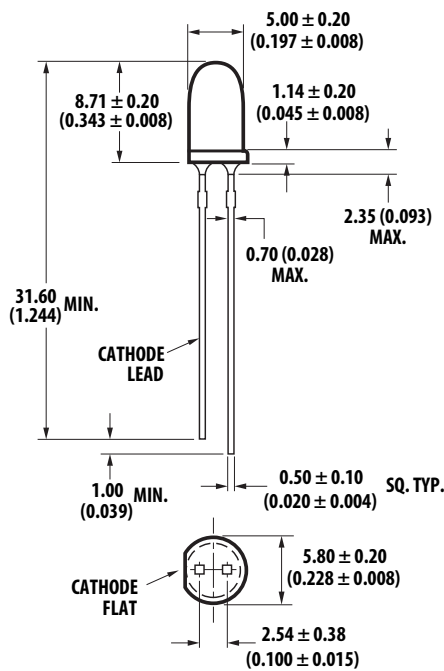

PACKAGE DIMENSION A

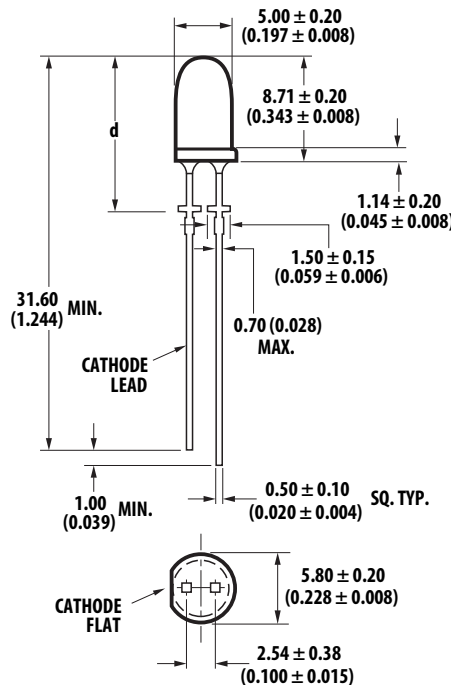

PACKAGE DIMENSION B

HLMP-Cx14	HLMP-Cx25	HLMP-Cx35
d = 12.6 ± 0.25 (0.496 ± 0.010)	d = 12.52 ± 0.25 (0.493 ± 0.010)	d = 11.96 ± 0.25 (0.471 ± 0.010)

Notes:

1. Measured just above flange.
2. All dimensions are in millimeters (inches).
3. Epoxy meniscus may extend about 1mm (0.040") down the leads.

Caution: InGaN devices are Class 1C HBM ESD sensitive per JEDEC standard. Please observe appropriate precautions during handling and processing. Refer to Avago Application Note AN 1142 for details.

Device Selection Guide

Part Number	Color	Typical Viewing Angle, 2 θ $\frac{1}{2}$ (Degree)	Intensity (mcd) at 20 mA		Leads with Stand-Offs
			Min.	Max.	
HLMP-CB13-UX0xx	Blue	15°	3200	9300	No
HLMP-CB14-UX0xx	Blue	15°	3200	9300	Yes
HLMP-CB22-SV0xx	Blue	23°	1900	5500	No
HLMP-CB25-SV0xx	Blue	23°	1900	5500	Yes
HLMP-CB34-RU0xx	Blue	30°	1500	4200	No
HLMP-CB35-RU0xx	Blue	30°	1500	4200	Yes
HLMP-CM13-Z30xx	Green	15°	12000	35000	No
HLMP-CM14-Z30xx	Green	15°	12000	35000	Yes
HLMP-CM22-X10xx	Green	23°	7200	21000	No
HLMP-CM25-X10xx	Green	23°	7200	21000	Yes
HLMP-CM34-X10xx	Green	30°	7200	21000	No
HLMP-CM35-X10xx	Green	30°	7200	21000	Yes

Notes:

1. Tolerance for luminous intensity measurement is $\pm 15\%$
2. The optical axis is closely aligned with the package mechanical axis.
3. LED light output is bright enough to cause injuries to the eyes. Precautions must be taken to prevent looking directly at the LED without proper safety equipment.
4. 2 θ 1/2 is the off-axis angle where the luminous intensity is $\frac{1}{2}$ the on axis intensity.

Part Numbering System

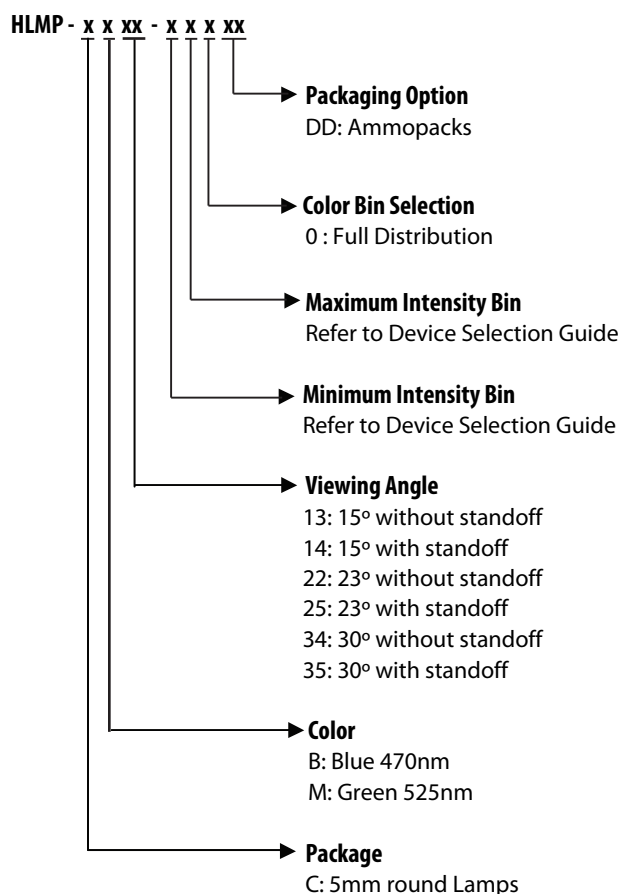

Note: Please refer to AB 5337 for complete information on part numbering system.

Absolute Maximum Rating ($T_A = 25^\circ\text{C}$)

Parameters	Value	Unit
DC forward current ^[1]	30	mA
Peak pulsed forward current ^[2]	100	mA
Power dissipation	116	mW
LED junction temperature	110	°C
Operating temperature range	-40 to +85	°C
Storage temperature range	-40 to +100	°C

Notes:

1. Derate linearly as shown in figure 2.
2. Duty factor 10%, frequency 1KHz.

Electrical/Optical Characteristics ($T_A = 25^\circ\text{C}$)

Parameters	Symbol	Blue and Green			Units	Test Condition
		Min	Typ	Max		
Forward Voltage	V_F	2.8	3.2	3.8	V	$I_F = 20\text{ mA}$
Reverse Voltage ^[1]	V_R	5.0			V	$I_R = 10\ \mu\text{A}$
Thermal resistance	$R\theta_{J-PIN}$		240		°C/W	LED Junction to cathode lead
Dominant wavelength ^[2]	λ_d				nm	$I_F = 20\text{ mA}$
Blue		460	470	480		
Green		520	525	540		
Peak wavelength	λ_{PEAK}				nm	Peak of wavelength of spectral distribution at $I_F = 20\text{ mA}$
Blue			464			
Green			516			
Spectral half width	$\Delta\lambda_{1/2}$					Wavelength width at spectral distribution 1/2 power point at $I_F = 20\text{ mA}$
Blue			22			
Green			35			
Luminous Efficacy ^[3]	η_v				lm/W	Emitted luminous power/Emitted radiant power
Blue			78			
Green			545			
Luminous Flux	ϕ_v				mlm	$I_F = 20\text{mA}$
Blue			830			
Green			3500			
Luminous Efficiency ^[4]	η_ϵ				lm/W	Luminous Flux/Electrical Power at $I_F = 20\text{mA}$
Blue			13			
Green			56			

Notes:

1. The reverse voltage of the product is equivalent to the forward voltage of the protective chip at $I_R = 10\ \mu\text{A}$
2. The dominant wavelength λ_d is derived from the Chromaticity Diagram and represents the color of the lamp.
3. The radiant intensity, I_e in watts/steradian, may be found from the equation $I_e = I_v/\eta_v$, where I_v is the luminous intensity in candelas and η_v is the luminous efficacy in lumens/watt.
4. $\eta_\epsilon = \phi_v / I_F \times V_F$ where ϕ_v is the emitted luminous flux, I_F is electrical forward current and V_F is the forward voltage.

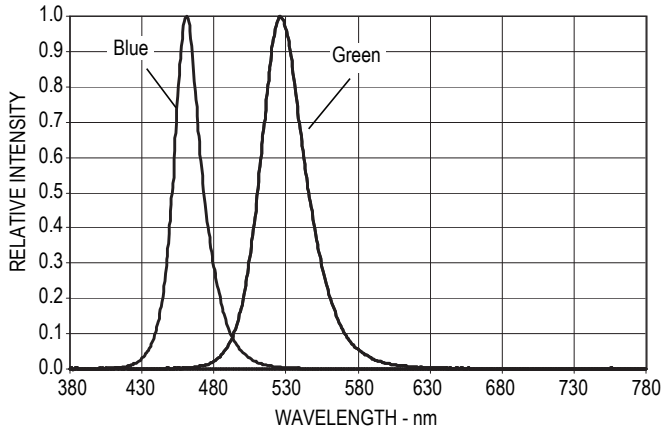

Figure 1. Relative Intensity vs. Wavelength

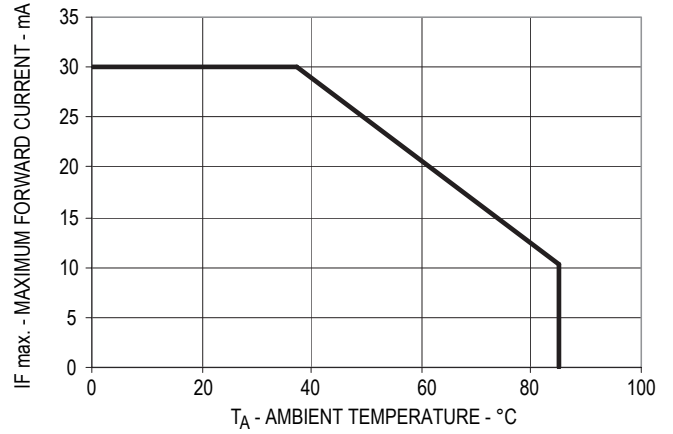

Figure 2. Forward Current vs. Ambient Temperature

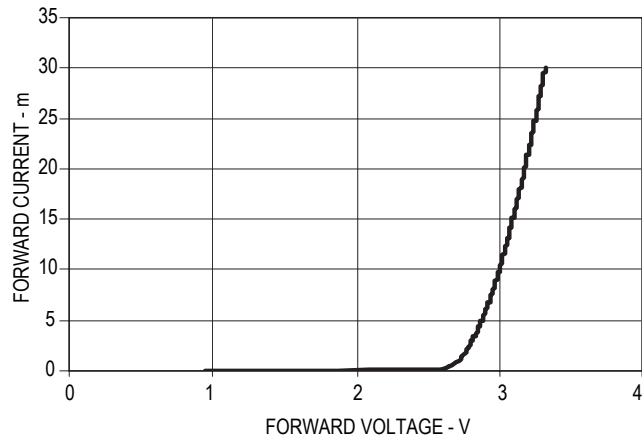

Figure 3. Forward Current vs. Forward Voltage

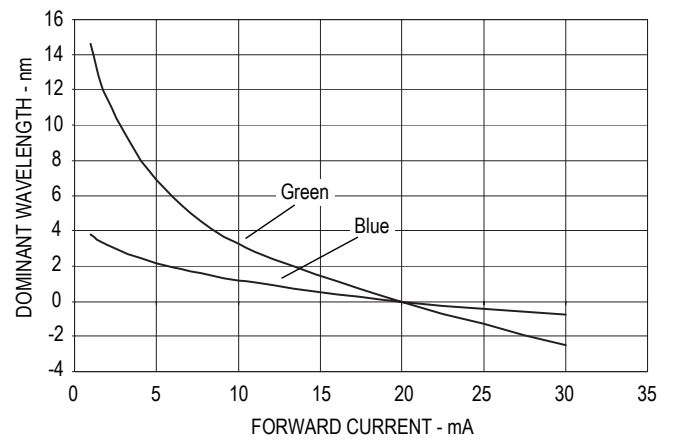

Figure 4. Relative Dominant Wavelength vs. DC Forward Current

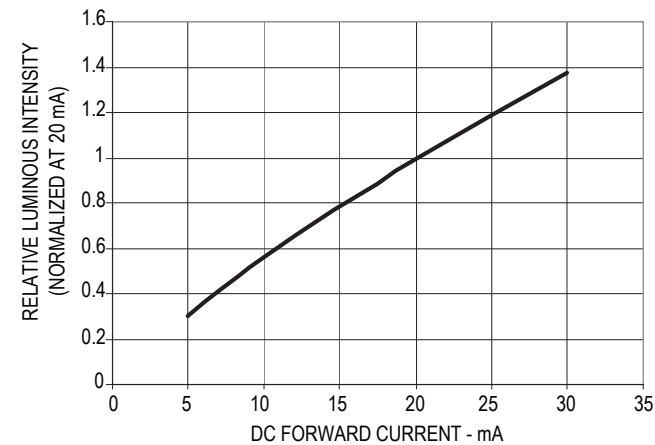

Figure 5. Relative Intensity vs. DC Forward Current

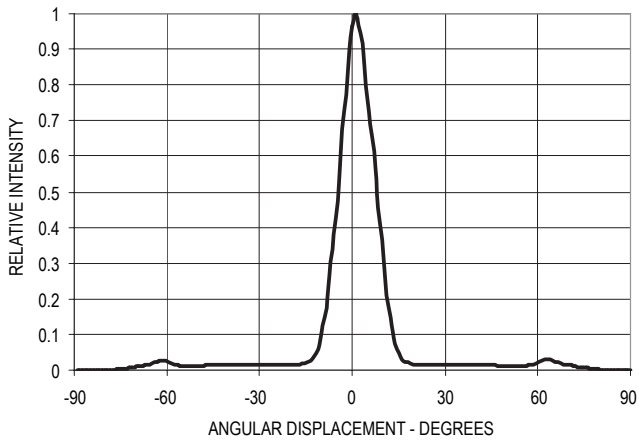

Figure 6. Spatial Radiation Pattern for 15° lamps

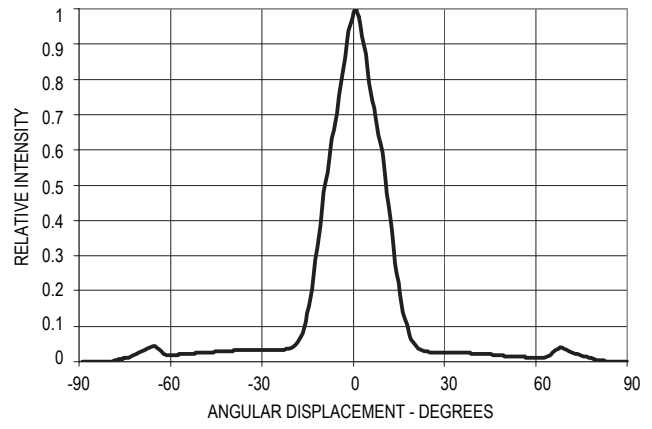

Figure 7. Spatial Radiation Pattern for 23° lamps

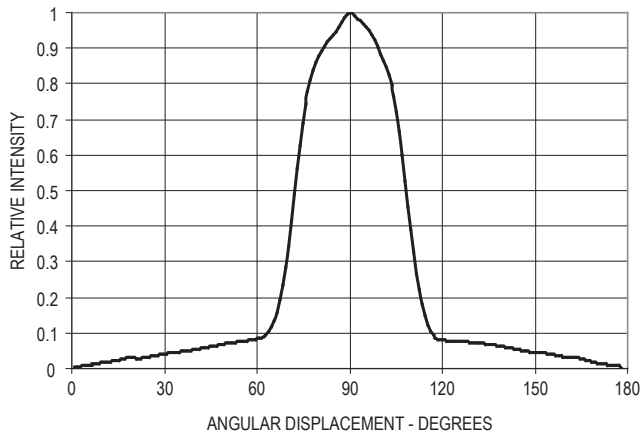

Figure 8. Spatial Radiation Pattern for 30° lamps

Note:

All bin categories are established for classification of products. Products may not be available in all bin categories. Please contact your Avago representative for further information

Intensity Bin Limit Table

Bin	Intensity (mcd) at 20 mA	
	Min	Max
R	1500	1900
S	1900	2500
T	2500	3200
U	3200	4200
V	4200	5500
W	5500	7200
X	7200	9300
Y	9300	12000
Z	12000	16000
1	16000	21000
2	21000	27000
3	27000	35000

Tolerance for each bin limit is +/- 15%

Green Color Bin Table

Bin	Min Dom	Max Dom	Xmin	Ymin	Xmax	Ymax
1	520.0	524.0	0.0743	0.8338	0.1856	0.6556
			0.1650	0.6586	0.1060	0.8292
2	524.0	528.0	0.1060	0.8292	0.2068	0.6463
			0.1856	0.6556	0.1387	0.8148
3	528.0	532.0	0.1387	0.8148	0.2273	0.6344
			0.2068	0.6463	0.1702	0.7965
4	532.0	536.0	0.1702	0.7965	0.2469	0.6213
			0.2273	0.6344	0.2003	0.7764
5	536.0	540.0	0.2003	0.7764	0.2659	0.6070
			0.2469	0.6213	0.2296	0.7543

Tolerance for each bin limit is $\pm 0.5\text{nm}$

Blue Color Bin Table

Bin	Min Dom	Max Dom	Xmin	Ymin	Xmax	Ymax
1	460.0	464.0	0.1440	0.0297	0.1766	0.0966
			0.1818	0.0904	0.1374	0.0374
2	464.0	468.0	0.1374	0.0374	0.1699	0.1062
			0.1766	0.0966	0.1291	0.0495
3	468.0	472.0	0.1291	0.0495	0.1616	0.1209
			0.1699	0.1062	0.1187	0.0671
4	472.0	476.0	0.1187	0.0671	0.1517	0.1423
			0.1616	0.1209	0.1063	0.0945
5	476.0	480.0	0.1063	0.0945	0.1397	0.1728
			0.1517	0.1423	0.0913	0.1327

Tolerance for each bin limit is $\pm 0.5\text{nm}$

Relative Light Output vs. Junction Temperature

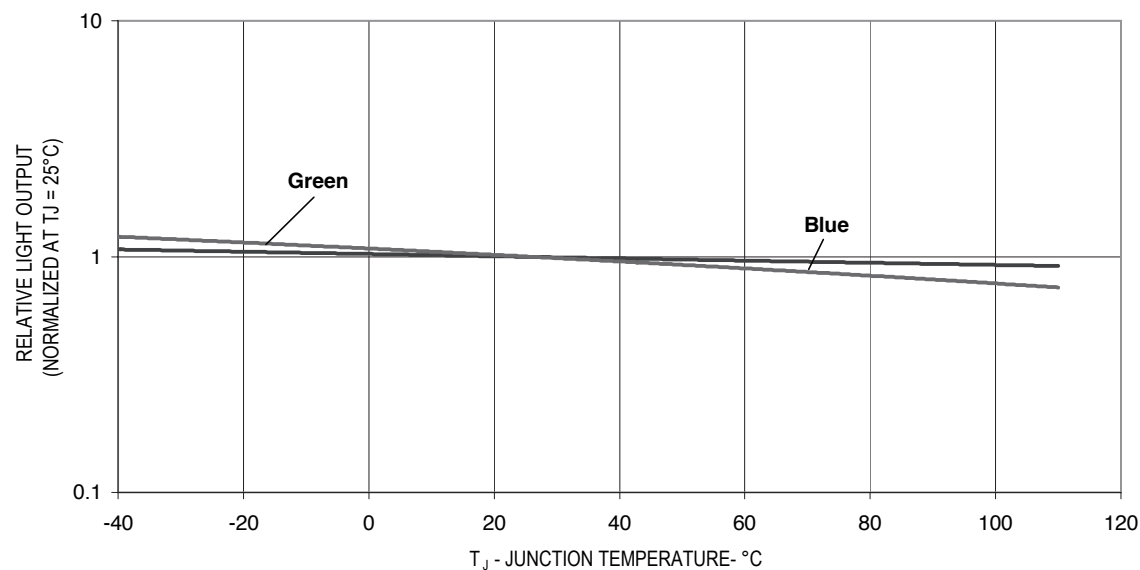

Precautions:

Lead Forming:

- The leads of an LED lamp may be preformed or cut to length prior to insertion and soldering on PC board.
- For better control, it is recommended to use proper tool to precisely form and cut the leads to applicable length rather than doing it manually.
- If manual lead cutting is necessary, cut the leads after the soldering process. The solder connection forms a mechanical ground which prevents mechanical stress due to lead cutting from traveling into LED package. This is highly recommended for hand solder operation, as the excess lead length also acts as small heat sink.

Soldering and Handling:

- Care must be taken during PCB assembly and soldering process to prevent damage to the LED component.
- LED component may be effectively hand soldered to PCB. However, it is only recommended under unavoidable circumstances such as rework. The closest manual soldering distance of the soldering heat source (soldering iron's tip) to the body is 1.59mm. Soldering the LED using soldering iron tip closer than 1.59mm might damage the LED.

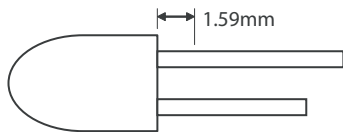

- ESD precaution must be properly applied on the soldering station and personnel to prevent ESD damage to the LED component that is ESD sensitive. Do refer to Avago application note AN 1142 for details. The soldering iron used should have grounded tip to ensure electrostatic charge is properly grounded.
- Recommended soldering condition:

	Wave Soldering [1, 2]	Manual Solder Dipping
Pre-heat temperature	105 °C Max.	-
Preheat time	60 sec Max	-
Peak temperature	250 °C Max.	260 °C Max.
Dwell time	3 sec Max.	5 sec Max

Note:

- 1) Above conditions refers to measurement with thermocouple mounted at the bottom of PCB.
 - 2) It is recommended to use only bottom preheaters in order to reduce thermal stress experienced by LED.
- Wave soldering parameters must be set and maintained according to the recommended temperature and dwell time. Customer is advised to perform daily check on the soldering profile to ensure that it is always conforming to recommended soldering conditions.

Note:

1. PCB with different size and design (component density) will have different heat mass (heat capacity). This might cause a change in temperature experienced by the board if same wave soldering setting is used. So, it is recommended to re-calibrate the soldering profile again before loading a new type of PCB.

Avago Technologies LED configuration

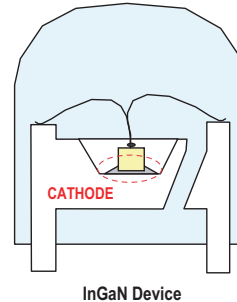

Note: Electrical connection between bottom surface of LED die and the lead frame is achieved through conductive paste.

- Any alignment fixture that is being applied during wave soldering should be loosely fitted and should not apply weight or force on LED. Non metal material is recommended as it will absorb less heat during wave soldering process.
- At elevated temperature, LED is more susceptible to mechanical stress. Therefore, PCB must allowed to cool down to room temperature prior to handling, which includes removal of alignment fixture or pallet.
- If PCB board contains both through hole (TH) LED and other surface mount components, it is recommended that surface mount components be soldered on the top side of the PCB. If surface mount need to be on the bottom side, these components should be soldered using reflow soldering prior to insertion the TH LED.
- Recommended PC board plated through holes (PTH) size for LED component leads.

LED component lead size	Diagonal	Plated through hole diameter
0.45 x 0.45 mm (0.018x 0.018 inch)	0.636 mm (0.025 inch)	0.98 to 1.08 mm (0.039 to 0.043 inch)
0.50 x 0.50 mm (0.020x 0.020 inch)	0.707 mm (0.028 inch)	1.05 to 1.15 mm (0.041 to 0.045 inch)

- Over-sizing the PTH can lead to twisted LED after clinching. On the other hand under sizing the PTH can cause difficulty inserting the TH LED.

Refer to Application Note 5334 for more information about soldering and handling of high brightness TH LED lamps.

Example of Wave Soldering Temperature Profile for TH LED

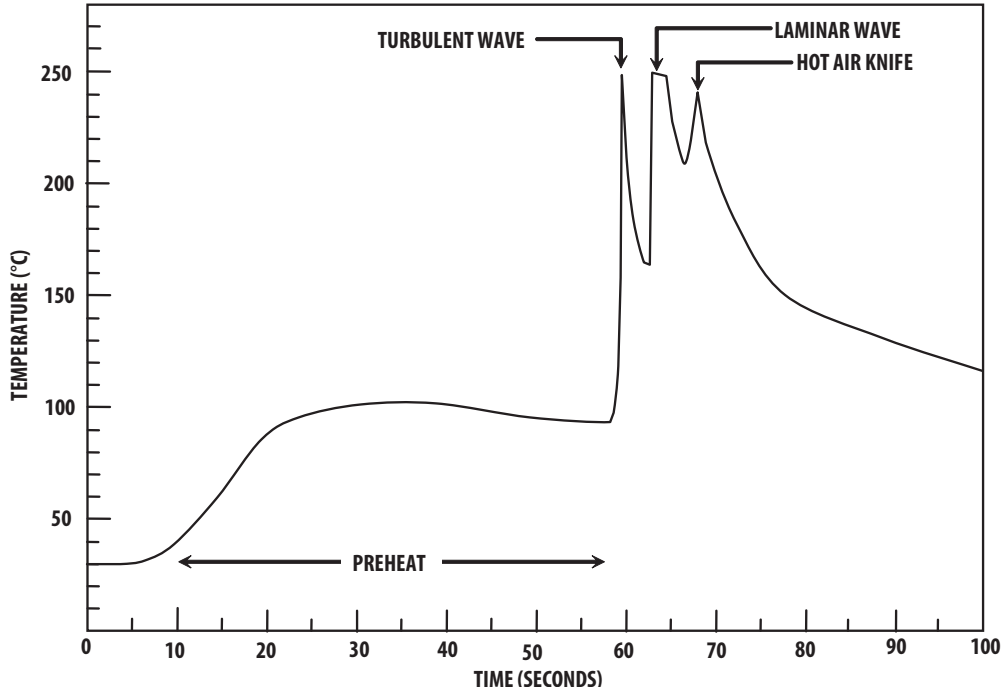

Recommended solder:
Sn63 (Leaded solder alloy)
SAC305 (Lead free solder alloy)

Flux: Rosin flux

Solder bath temperature:
245°C ± 5°C (maximum peak
temperature = 250°C)

Dwell time: 1.5 sec - 3.0 sec
(maximum = 3sec)

Note: Allow for board to be
sufficiently cooled to room
temperature before exerting
mechanical force.

Ammo Packs Drawing

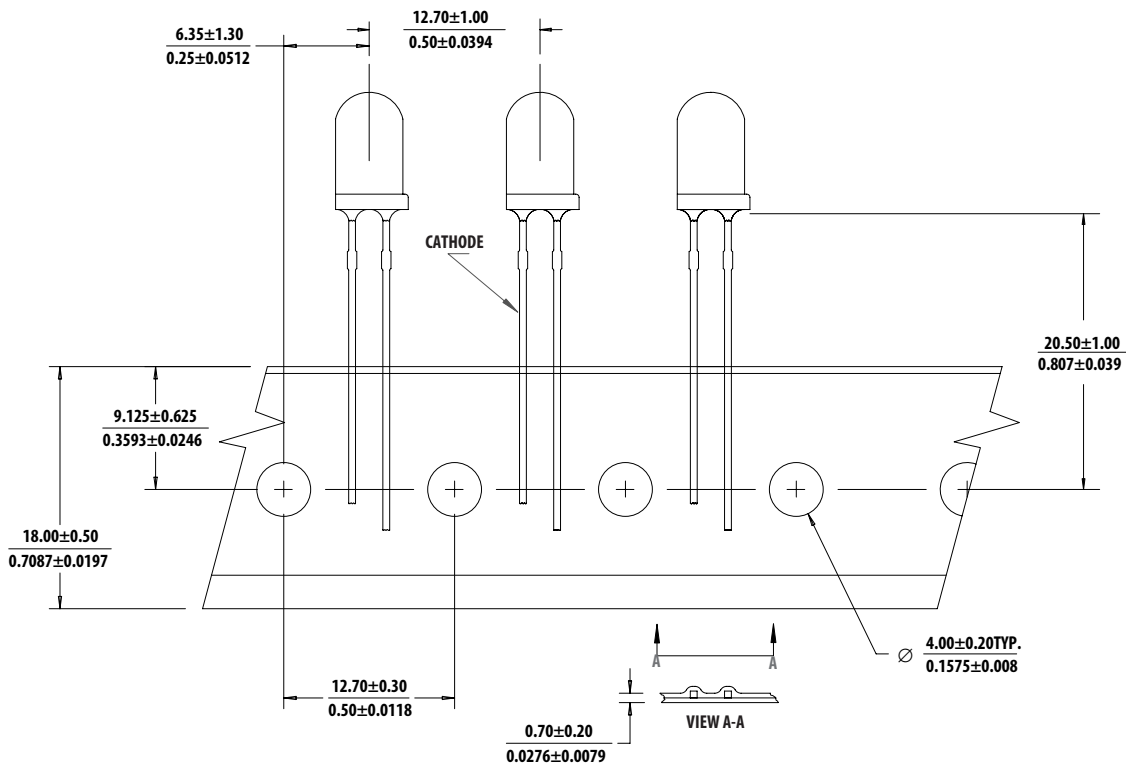

Note: The ammo-packs drawing is applicable for packaging option -DD & -ZZ and regardless standoff or non-standoff.

Packaging Box for Ammo Packs

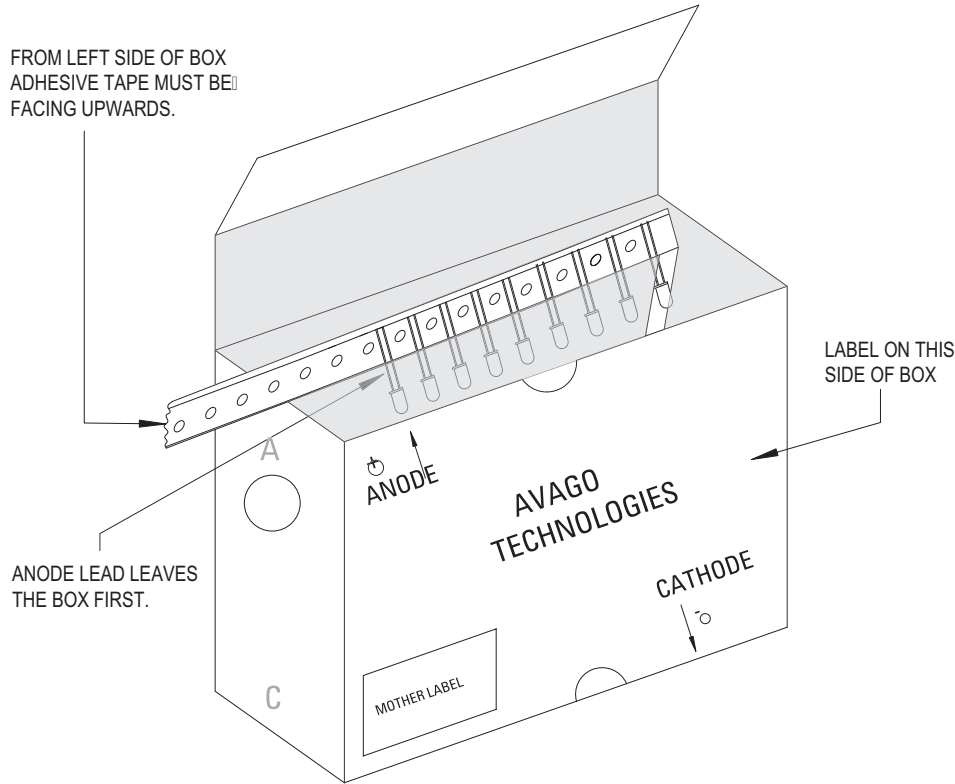











Note: For InGaN device, the ammo pack packaging box contain ESD logo

Packaging Label

(i) Avago Mother Label: (Available on packaging box of ammo pack and shipping box)

AVAGO TECHNOLOGIES	
(1P) Item: Part Number [Barcode]	STANDARD LABEL LS0002 RoHS Compliant e3 max temp 250C
(1T) Lot: Lot Number [Barcode]	(Q) QTY: Quantity [Barcode]
LPN: [Barcode]	CAT: Intensity Bin [Barcode]
(9D)MFG Date: Manufacturing Date [Barcode]	BIN: Refer to below information
<hr/>	
(P) Customer Item: [Barcode]	
(V) Vendor ID: [Barcode]	(9D) Date Code: Date Code [Barcode]
DeptID: [Barcode]	Made In: Country of Origin [Barcode]

(ii) Avago Baby Label (Only available on bulk packaging)

 Avago TECHNOLOGIES		RoHS Compliant e3 max temp 250C
Lamps Baby Label		
(1P) PART #: Part Number		
		
(1T) LOT #: Lot Number		
		
(9D)MFG DATE: Manufacturing Date	QUANTITY: Packing Quantity	
		
C/O: Country of Origin		
Customer P/N: 	CAT: Intensity Bin 	
Supplier Code: 	BIN: Refer to below information 	
	DATECODE: Date Code 	

Acronyms and Definition:

BIN:

(i) Color bin only or VF bin only

(Applicable for part number with color bins but without VF bin OR part number with VF bins and no color bin)

OR

(ii) Color bin incorporated with VF Bin

(Applicable for part number that have both color bin and VF bin)

Example:

(i) Color bin only or VF bin only

BIN: 2 (represent color bin 2 only)

BIN: VB (represent VF bin "VB" only)

(ii) Color bin incorporate with VF Bin

BIN: 2VB

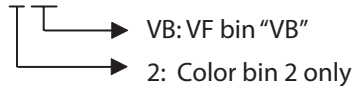

DISCLAIMER: AVAGO'S PRODUCTS AND SOFTWARE ARE NOT SPECIFICALLY DESIGNED, MANUFACTURED OR AUTHORIZED FOR SALE AS PARTS, COMPONENTS OR ASSEMBLIES FOR THE PLANNING, CONSTRUCTION, MAINTENANCE OR DIRECT OPERATION OF A NUCLEAR FACILITY OR FOR USE IN MEDICAL DEVICES OR APPLICATIONS. CUSTOMER IS SOLELY RESPONSIBLE, AND WAIVES ALL RIGHTS TO MAKE CLAIMS AGAINST AVAGO OR ITS SUPPLIERS, FOR ALL LOSS, DAMAGE, EXPENSE OR LIABILITY IN CONNECTION WITH SUCH USE.

For product information and a complete list of distributors, please go to our web site: www.avagotech.com

Avago, Avago Technologies, and the A logo are trademarks of Avago Technologies in the United States and other countries.

Data subject to change. Copyright © 2005-2014 Avago Technologies. All rights reserved.

AV02-0678EN - July 18, 2014

