



October 2014

# MPSA42 / MMBTA42 / PZTA42 NPN High-Voltage Amplifier

## Features

- This device is designed for application as a video output and other high-voltage applications.
- Sourced from process 48.

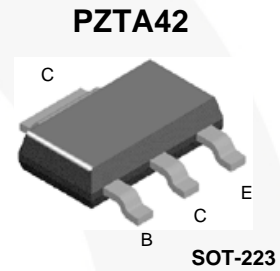
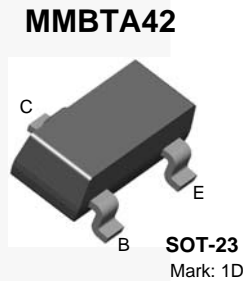
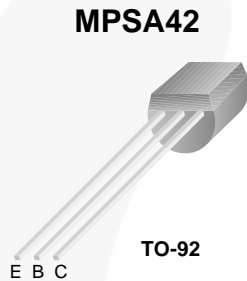

## Ordering Information

Part Number	Top Mark	Package	Packing Method
MPSA42	MPSA42	TO-92 3L	Bulk
MMBTA42	1D	SOT-23 3L	Tape and Reel
PZTA42	A42	SOT-223 4L	Tape and Reel

## Absolute Maximum Ratings<sup>(1), (2)</sup>

Stresses exceeding the absolute maximum ratings may damage the device. The device may not function or be operable above the recommended operating conditions and stressing the parts to these levels is not recommended. In addition, extended exposure to stresses above the recommended operating conditions may affect device reliability. The absolute maximum ratings are stress ratings only. Values are at  $T_A = 25^\circ\text{C}$  unless otherwise noted.

Symbol	Parameter	Value	Unit
$V_{CEO}$	Collector-Emitter Voltage	300	V
$V_{CBO}$	Collector-Base Voltage	300	V
$V_{EBO}$	Emitter-Base Voltage	6	V
$I_C$	Collector Current - Continuous	500	mA
$T_J, T_{STG}$	Operating and Storage Junction Temperature Range	-55 to +150	$^\circ\text{C}$

### Notes:

1. These ratings are based on a maximum junction temperature of  $150^\circ\text{C}$ .
2. These are steady-state limits. Fairchild Semiconductor should be consulted on applications involving pulsed or low-duty-cycle operations.

MPSA42 / MMBTA42 / PZTA42 — NPN High-Voltage Amplifier

## Thermal Characteristics

Values are at  $T_A = 25^\circ\text{C}$  unless otherwise noted.

Symbol	Parameter	Max.			Unit
		MPSA42	MMBTA42 <sup>(3)</sup>	PZTA42 <sup>(4)</sup>	
$P_D$	Total Device Dissipation	625	240	1000	mW
	Derate Above $25^\circ\text{C}$	5.00	1.92	8.00	mW/ $^\circ\text{C}$
$R_{\theta JC}$	Thermal Resistance, Junction-to-Case	83.3			$^\circ\text{C}/\text{W}$
$R_{\theta JA}$	Thermal Resistance, Junction-to-Ambient	200	515	125	$^\circ\text{C}/\text{W}$

### Notes:

- Device is mounted on FR-4 PCB 1.6 inch x 1.6 inch x 0.06 inch.
- Device is mounted on FR-4 PCB 36 mm x 18 mm x 1.5 mm, mounting pad for the collector lead minimum 6 cm<sup>2</sup>.

## Electrical Characteristics

Values are at  $T_A = 25^\circ\text{C}$  unless otherwise noted.

Symbol	Parameter	Conditions	Min.	Max.	Unit
<b>Off Characteristics</b>					
$V_{(BR)CEO}$	Collector-Emitter Breakdown Voltage <sup>(5)</sup>	$I_C = 1.0 \text{ mA}, I_B = 0$	300		V
$V_{(BR)CBO}$	Collector-Base Breakdown Voltage	$I_C = 100 \mu\text{A}, I_E = 0$	300		V
$V_{(BR)EBO}$	Emitter-Base Breakdown Voltage	$I_E = 100 \mu\text{A}, I_C = 0$	6		V
$I_{CBO}$	Collector Cut-Off Current	$V_{CB} = 200 \text{ V}, I_E = 0$		0.1	$\mu\text{A}$
$I_{EBO}$	Emitter Cut-Off Current	$V_{EB} = 6 \text{ V}, I_C = 0$		0.1	$\mu\text{A}$
<b>On Characteristics<sup>(5)</sup></b>					
$h_{FE}$	DC Current Gain	$V_{CE} = 10 \text{ V}, I_C = 1.0 \text{ mA}$	25		
		$V_{CE} = 10 \text{ V}, I_C = 10 \text{ mA}$	40		
		$V_{CE} = 10 \text{ V}, I_C = 30 \text{ mA}$	40		
$V_{CE(sat)}$	Collector-Emitter Saturation Voltage	$I_C = 20 \text{ mA}, I_B = 2.0 \text{ mA}$		0.5	V
$V_{BE(sat)}$	Base-Emitter Saturation Voltage	$I_C = 20 \text{ mA}, I_B = 2.0 \text{ mA}$		0.9	V
<b>Small Signal Characteristics</b>					
$f_T$	Current Gain - Bandwidth Product	$I_C = 10 \text{ mA}, V_{CE} = 20 \text{ V}, f = 100 \text{ MHz}$	50		MHz
$C_{cb}$	Collector-Base Capacitance	$V_{CB} = 20 \text{ V}, I_E = 0, f = 1.0 \text{ MHz}$		3.0	pF

### Notes:

- Pulse test: pulse width  $\leq 300 \mu\text{s}$ , duty cycle  $\leq 2\%$ .

## Typical Performance Characteristics

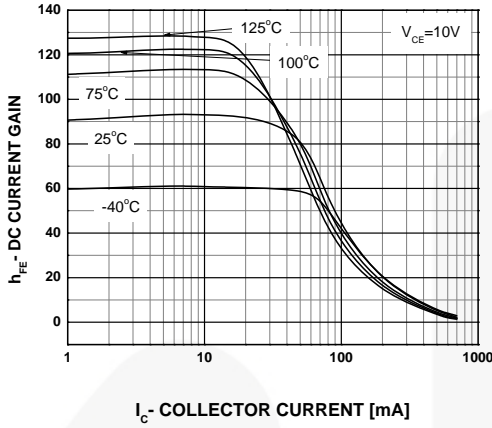

Figure 1. DC Current Gain vs. Collector Current

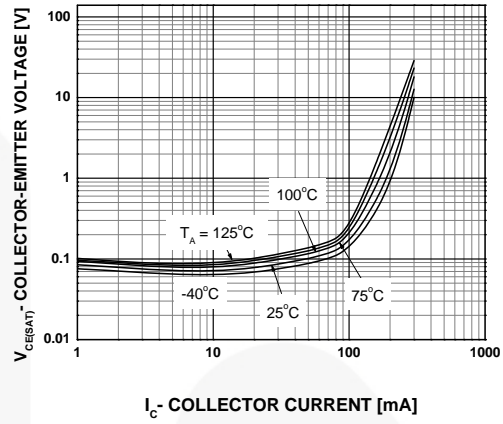

Figure 2. Collector-Emitter Saturation Voltage vs. Collector Current

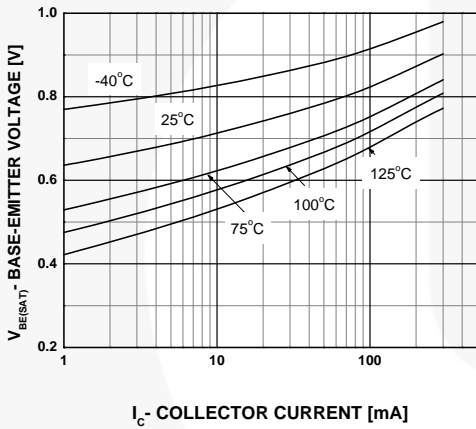

Figure 3. Base-Emitter Saturation Voltage vs. Collector Current

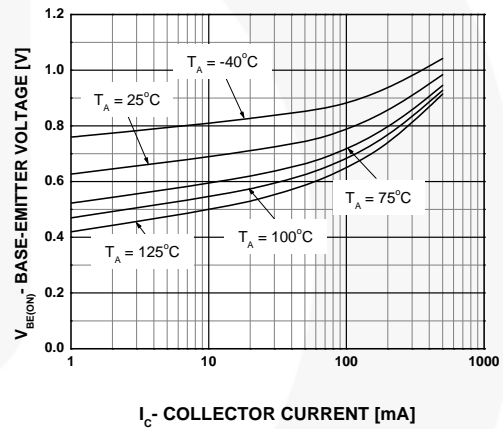

Figure 4. Base-Emitter On Voltage vs. Collector Current

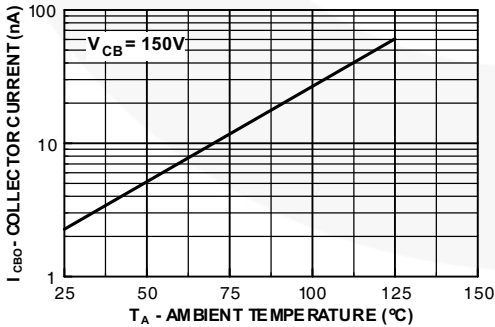

Figure 5. Collector Cut-Off Current vs. Ambient Temperature

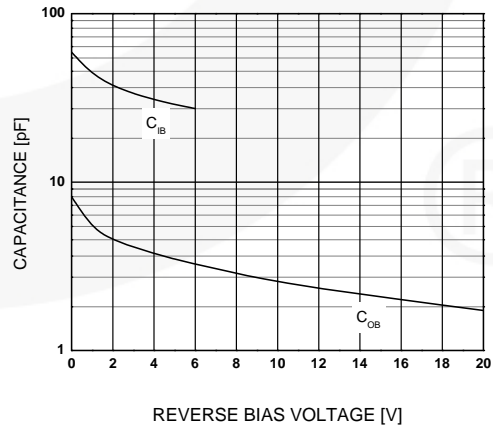

Figure 6. Collector-Base and Emitter-Base Capacitance vs. Reverse-Bias Voltage

### Typical Performance Characteristics (Continued)

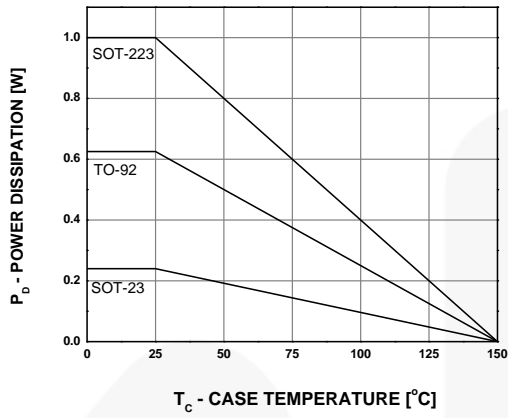
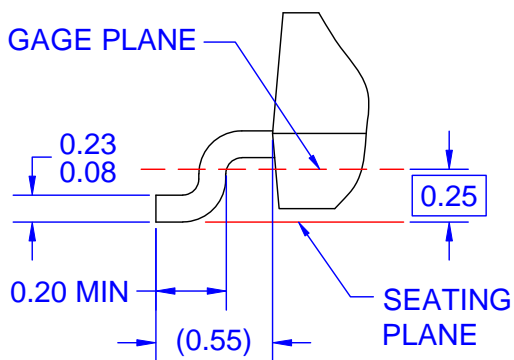
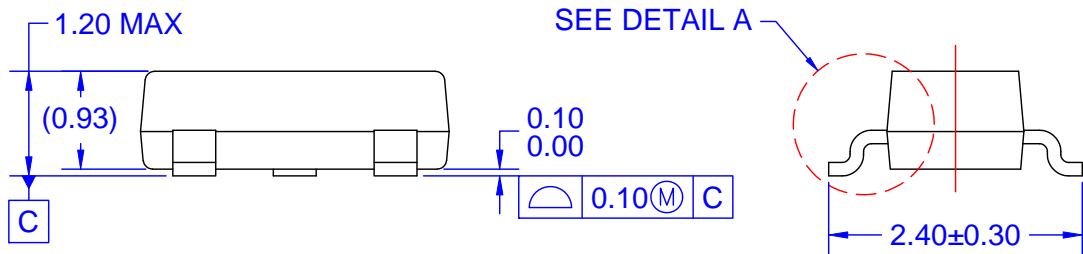

Figure 7. Power Dissipation vs. Ambient Temperature





**DETAIL A**  
SCALE: 2X

NOTES: UNLESS OTHERWISE SPECIFIED

- A) REFERENCE JEDEC REGISTRATION TO-236, VARIATION AB, ISSUE H.
- B) ALL DIMENSIONS ARE IN MILLIMETERS.
- C) DIMENSIONS ARE INCLUSIVE OF BURRS, MOLD FLASH AND TIE BAR EXTRUSIONS.
- D) DIMENSIONING AND TOLERANCING PER ASME Y14.5M - 1994.
- E) DRAWING FILE NAME: MA03DREV10

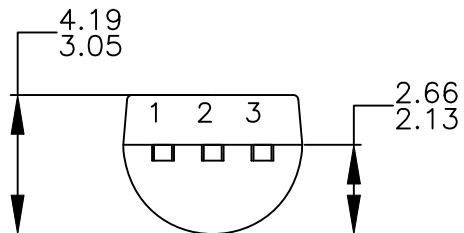
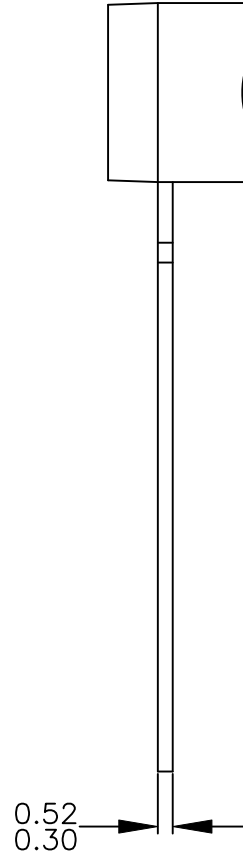
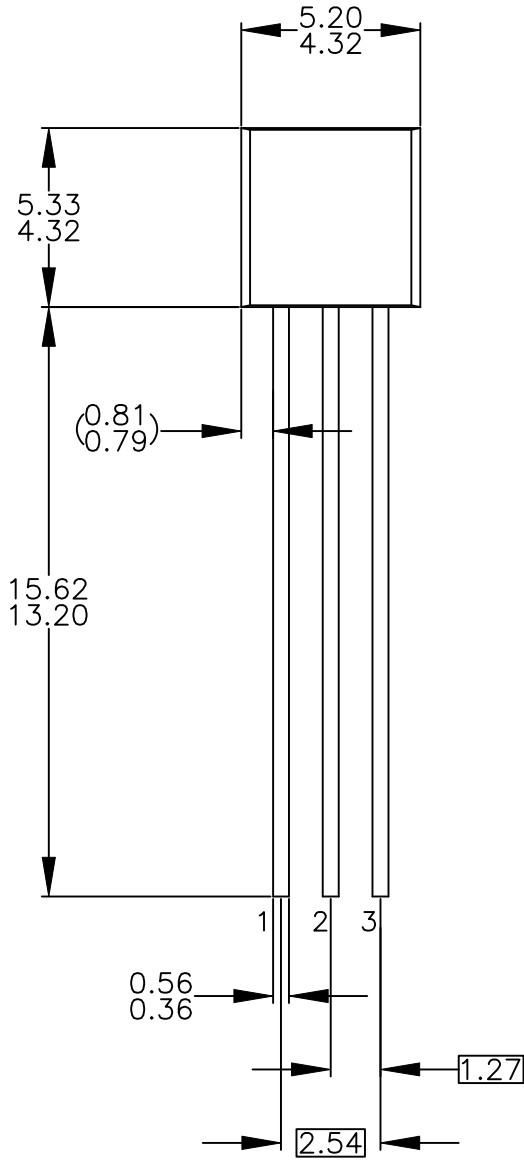

NOTES: UNLESS OTHERWISE SPECIFIED

- A) DRAWING WITH REFERENCE TO JEDEC TO-92 RECOMMENDATIONS.
- B) ALL DIMENSIONS ARE IN MILLIMETERS.
- C) DRAWING CONFORMS TO ASME Y14.5M-2009.
- D) DRAWING FILENAME: MKT-ZA03DREV4.



THIS DRAWING IS THE PROPERTY OF FAIRCHILD SEMICONDUCTOR CORPORATION. NO USE THEREOF SHALL BE MADE OTHER THAN AS A REFERENCE FOR PROPOSALS AS SUBMITTED TO FAIRCHILD SEMICONDUCTOR CORPORATION FOR OBS TO BE EXECUTED IN CONFORMANCE WITH SUCH PROPOSALS UNLESS THE CONSENT OF SAID FAIRCHILD SEMICONDUCTOR CORPORATION HAS PREVIOUSLY BEEN OBTAINED. NO PART OF THIS DRAWING SHALL BE COPIED OR DUPLICATED OR ITS CONTENTS DISCLOSED. THE INFORMATION CONTAINED ON THIS DRAWING IS CONFIDENTIAL AND PROPRIETARY.

**APPROVED**  
July-14-2008

REVISIONS			
LTR	DESCRIPTION	DATE	NAME/SITE
A	RELEASE TO DOCUMENT CONTROL	JAN.25,1996	TL/FSCP
2	CHG DWG TEMPLATE FR NATIONAL TO FAIRCHILD; CHG DIM STYLE FR DUAL INCH[MM] TO SINGLE, MM; CHG LD WID FR 0.74 <del>±0.03</del> TO 0.60-0.84; REMOVE PKG THICK DIM (1.6); CHG TOTAL PKG HT FR 1.8 <del>±0.05</del> TO 1.80 MAX; CHG FOOT LANDING DIM FR 0.91 MIN TO 0.60 MIN; CHG LD THICKNESS FR 0.35 <del>±0.03</del> TO 0.20-0.35; ADD DRAFT ANGLE OF MOLDED BODY TOP & BOT; CHG LD LGTH TO PKG EDGE DIM TO BASIC; CHG LD PITCH FR 2.29 BS TO 2.30 BS; CHG BODY WID FR 3.56 <del>±0.33</del> TO 3.3; CHG BODY LN FR 6.53 <del>±0.33</del> TO 6.3; CHG TOTAL PKG WID FR 6.94 <del>±0.33</del> TO 7.3; CHG PAD SIZE FR 0.99 MAX TO 0.95; CHG PAD PITCH FR 2.286 TO 2.30; CHG THERMAL TAB SIZE FR 3.28 MAX TO 3.25; CHG PAD SIZE FR 1.5 TO 1.90; CHG PAD SPACE FR 6.3 TO 6.10; CHG NOTE '2' TO 'A' W/O DATE; DEL NOTE ON LD FINISH; ADD NOTES B, C, D, E & F.	12FEB08	LZSC/FSCP

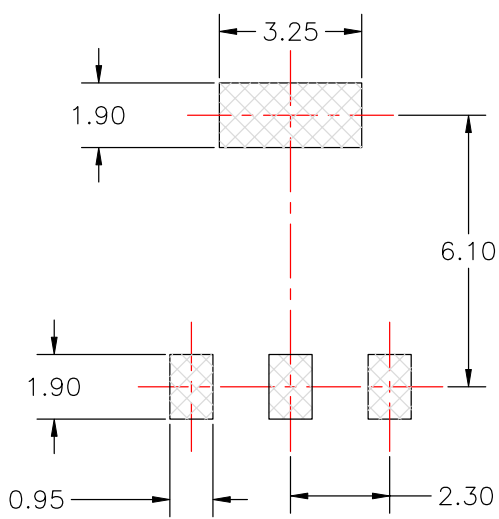
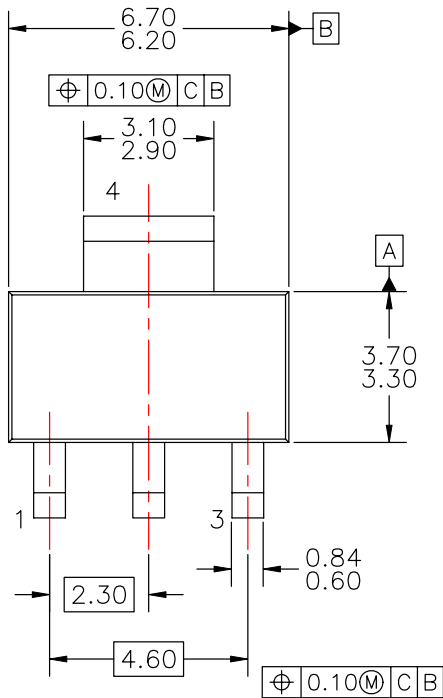

LAND PATTERN RECOMMENDATION

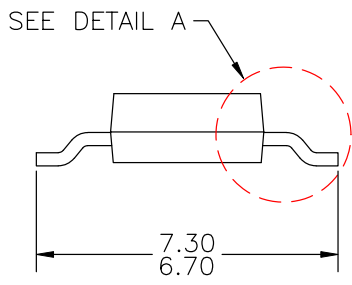
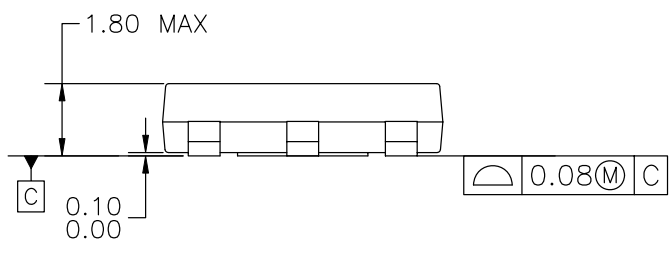

- NOTES: UNLESS OTHERWISE SPECIFIED
- A) DRAWING BASED ON JEDEC REGISTRATION TO-261, VARIATION AA.
  - B) DIMENSIONS ARE INCLUSIVE OF BURRS, MOLD FLASH AND TIE BAR EXTRUSIONS.
  - C) ALL DIMENSIONS ARE IN MILLIMETERS.
  - D) DRAWING CONFORMS TO ASME Y14.5M-1994.
  - E) LANDPATTERN NAME: SOT230P700X180-4BN
  - F) DRAWING FILENAME: MKT-MA04AREV2

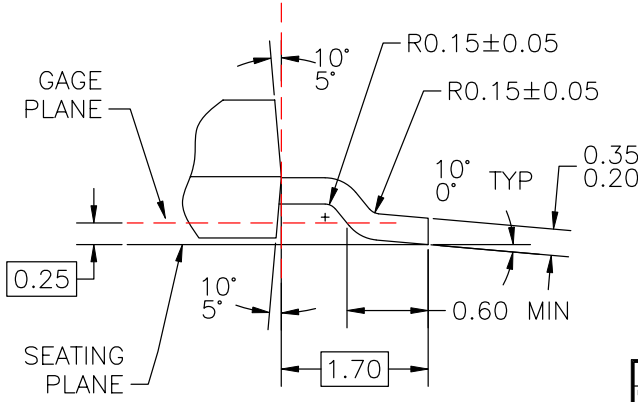





DETAIL A  
SCALE: 2:1

APPROVALS	DATE	<b>FAIRCHILD</b> SEMICONDUCTOR™
DRN: J.U. COMPARATIVO JR.	26FEB2008	
CHEK: L.Z. STA CRUZ		
APPROV: M.R. GESTOLE		
G.S. BAJE		<b>MOLDED PACKAGE</b> <b>SOT-223, 4 LEAD</b>
		SCALE: 1:1
		SIZE: A3
		DRAWING NUMBER: MKT-MA04A
		REV: 2
		FORMERLY: N/A
		SHEET: 1 OF 1



### TRADEMARKS

The following includes registered and unregistered trademarks and service marks, owned by Fairchild Semiconductor and/or its global subsidiaries, and is not intended to be an exhaustive list of all such trademarks.

- |   |  |   |   |
|---|--|---|---|
| AccuPower™  | F-PFS™   | OPTOPLANAR®   |  SYSTEM GENERAL® |
| AttitudeEngine™   | FRFET®   |  ® | TinyBoost®  |
| Awinda®   | Global Power Resource <sup>SM</sup>            | Power Supply WebDesigner™   | TinyBuck®   |
| AX-CAP®*  | GreenBridge™                                   | PowerTrench®  | TinyCalc™   |
| BitSiC™   | Green FPS™                                     | PowerXS™  | TinyLogic®  |
| Build it Now™   | Green FPS™ e-Series™                           | Programmable Active Droop™  | TINYOPTO™   |
| CorePLUS™   | Gmax™  | QFET®   | TinyPower™  |
| CorePOWER™  | GTO™   | QS™   | TinyPWM™  |
| CROSSVOL™   | IntelliMAX™                                    | Quiet Series™   | TinyWire™   |
| CTL™  | ISOPLANAR™                                     | RapidConfigure™   | TranSiC™  |
| Current Transfer Logic™   | Making Small Speakers Sound Louder and Better™ |  ™ | TriFault Detect™  |
| DEUXPEED®   | MegaBuck™                                      | Saving our world, 1mW/W/kW at a time™   | TRUECURRENT®*   |
| Dual Cool™  | MICROCOUPLER™                                  | SignalWise™   | μSerDes™  |
| EcoSPARK®   | MicroFET™                                      | SmartMax™   |  SerDes®         |
| EfficientMax™   | MicroPak™                                      | SMART START™  | UHC®  |
| ESBC™   | MicroPak2™                                     | Solutions for Your Success™   | Ultra FRFET™  |
|  ® | MillerDrive™                                   | SPM®  | UniFET™   |
| Fairchild®  | MotionMax™                                     | STEALTH™  | VCX™  |
| Fairchild Semiconductor®  | MotionGrid®                                    | SuperFET®   | VisualMax™  |
| FACT Quiet Series™  | MTI®   | SuperSOT™-3   | VoltagePlus™  |
| FACT®   | MTX®   | SuperSOT™-6   | XS™   |
| FAST®   | MVN®   | SuperSOT™-8   | Xsens™  |
| FastvCore™  | mWSaver®                                       | SupreMOS®   | 仙童™   |
| FETBench™   | OptoHiT™                                       | SyncFET™  |   |
| FPS™  | OPTOLOGIC®                                     | Sync-Lock™  |   |

\* Trademarks of System General Corporation, used under license by Fairchild Semiconductor.

### DISCLAIMER

FAIRCHILD SEMICONDUCTOR RESERVES THE RIGHT TO MAKE CHANGES WITHOUT FURTHER NOTICE TO ANY PRODUCTS HEREIN TO IMPROVE RELIABILITY, FUNCTION, OR DESIGN. TO OBTAIN THE LATEST, MOST UP-TO-DATE DATASHEET AND PRODUCT INFORMATION, VISIT OUR WEBSITE AT [HTTP://WWW.FAIRCHILDSEMI.COM](http://www.fairchildsemi.com). FAIRCHILD DOES NOT ASSUME ANY LIABILITY ARISING OUT OF THE APPLICATION OR USE OF ANY PRODUCT OR CIRCUIT DESCRIBED HEREIN; NEITHER DOES IT CONVEY ANY LICENSE UNDER ITS PATENT RIGHTS, NOR THE RIGHTS OF OTHERS. THESE SPECIFICATIONS DO NOT EXPAND THE TERMS OF FAIRCHILD'S WORLDWIDE TERMS AND CONDITIONS, SPECIFICALLY THE WARRANTY THEREIN, WHICH COVERS THESE PRODUCTS.

### LIFE SUPPORT POLICY

FAIRCHILD'S PRODUCTS ARE NOT AUTHORIZED FOR USE AS CRITICAL COMPONENTS IN LIFE SUPPORT DEVICES OR SYSTEMS WITHOUT THE EXPRESS WRITTEN APPROVAL OF FAIRCHILD SEMICONDUCTOR CORPORATION.

As used herein:

1. Life support devices or systems are devices or systems which, (a) are intended for surgical implant into the body or (b) support or sustain life, and (c) whose failure to perform when properly used in accordance with instructions for use provided in the labeling, can be reasonably expected to result in a significant injury of the user.
2. A critical component in any component of a life support, device, or system whose failure to perform can be reasonably expected to cause the failure of the life support device or system, or to affect its safety or effectiveness.

### ANTI-COUNTERFEITING POLICY

Fairchild Semiconductor Corporation's Anti-Counterfeiting Policy. Fairchild's Anti-Counterfeiting Policy is also stated on our external website, [www.fairchildsemi.com](http://www.fairchildsemi.com), under Sales Support.

Counterfeiting of semiconductor parts is a growing problem in the industry. All manufacturers of semiconductor products are experiencing counterfeiting of their parts. Customers who inadvertently purchase counterfeit parts experience many problems such as loss of brand reputation, substandard performance, failed applications, and increased cost of production and manufacturing delays. Fairchild is taking strong measures to protect ourselves and our customers from the proliferation of counterfeit parts. Fairchild strongly encourages customers to purchase Fairchild parts either directly from Fairchild or from Authorized Fairchild Distributors who are listed by country on our web page cited above. Products customers buy either from Fairchild directly or from Authorized Fairchild Distributors are genuine parts, have full traceability, meet Fairchild's quality standards for handling and storage and provide access to Fairchild's full range of up-to-date technical and product information. Fairchild and our Authorized Distributors will stand behind all warranties and will appropriately address any warranty issues that may arise. Fairchild will not provide any warranty coverage or other assistance for parts bought from Unauthorized Sources. Fairchild is committed to combat this global problem and encourage our customers to do their part in stopping this practice by buying direct or from authorized distributors.

### PRODUCT STATUS DEFINITIONS

#### Definition of Terms

Datasheet Identification	Product Status	Definition
Advance Information	Formative / In Design	Datasheet contains the design specifications for product development. Specifications may change in any manner without notice.
Preliminary	First Production	Datasheet contains preliminary data; supplementary data will be published at a later date. Fairchild Semiconductor reserves the right to make changes at any time without notice to improve design.
No Identification Needed	Full Production	Datasheet contains final specifications. Fairchild Semiconductor reserves the right to make changes at any time without notice to improve the design.
Obsolete	Not In Production	Datasheet contains specifications on a product that is discontinued by Fairchild Semiconductor. The datasheet is for reference information only.