

Mega Power Dual IGBTMOD™ 1400 Amperes/1200 Volts

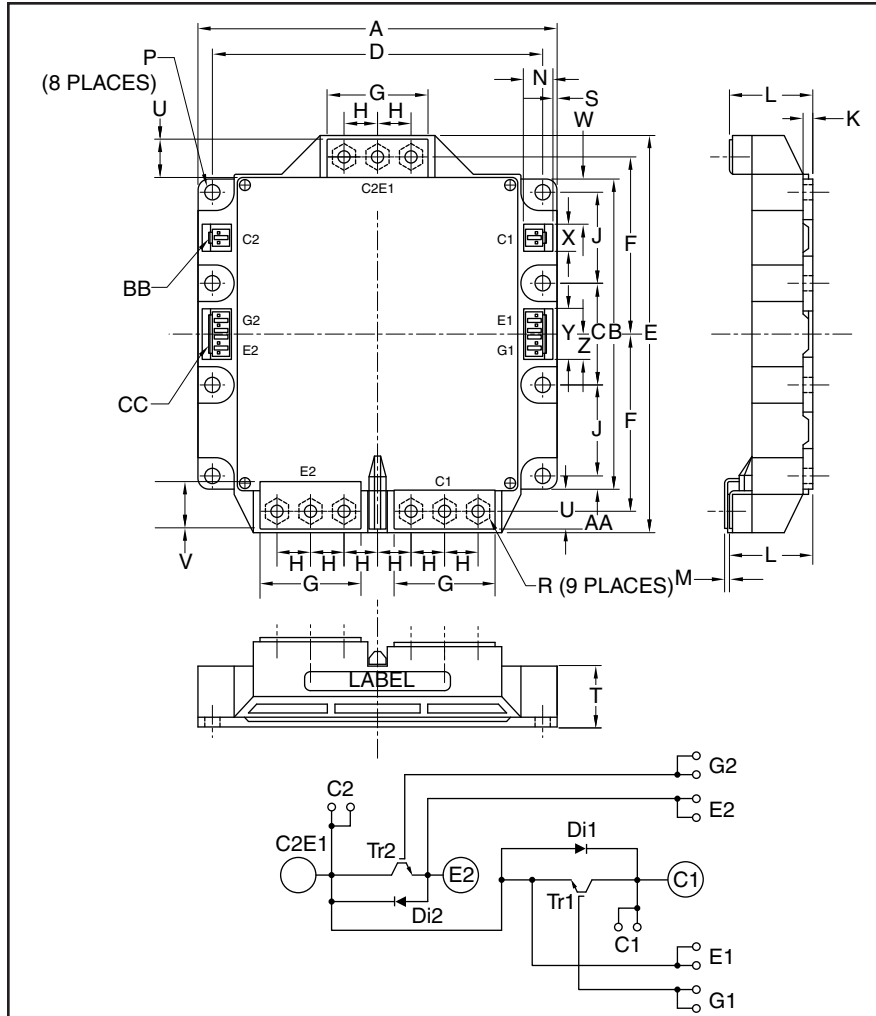

Outline Drawing and Circuit Diagram

Dimensions	Inches	Millimeters
A	5.91	150.0
B	5.10	129.5
C	1.67±0.01	42.5±0.25
D	5.41±0.01	137.5±0.25
E	6.54	166.0
F	2.91±0.01	74.0±0.25
G	1.65	42.0
H	0.55	14.0
J	1.50±0.01	38.0±0.25
K	0.16	4.0
L	1.36 +0.04/-0.02	34.6 +1.0/-0.5

Housing Type (J.S.T. MFG. CO. LTD)

BB = VHR-2N
CC = VHR-5N

Dimensions	Inches	Millimeters
M	0.075±0.008	1.9±0.2
N	0.47	12.0
P	0.26	6.5
R	M6 Metric	M6
S	0.08	2.0
T	0.99	25.1
U	0.62	15.7
V	0.71	18.0
W	0.75	19.0
X	0.43	11.0
Y	0.83	21.0
Z	0.41	10.5
AA	0.22	5.5



Description:

Powerex Mega Power Dual (MPD) Modules are designed for use in switching applications. Each module consists of two IGBT Transistors having a reverse-connected super-fast recovery free-wheel diode. All components and interconnects are isolated from the heat sinking baseplate, offering simplified system assembly and thermal management.

Features:

- Low Drive Power
- Low $V_{CE(sat)}$
- Discrete Super-Fast Recovery Free-Wheel Diode
- Isolated Baseplate for Easy Heatsinking
- RoHS Compliant

Applications:

- High Power DC Power Supply
- Large DC Motor Drives
- Utility Interface Inverters

Ordering Information:

Example: Select the complete module number you desire from the table - i.e. CM1400DUC-24NF is a 1200V (V_{CES}), 1400 Ampere Dual IGBTMOD Power Module.

Type	Current Rating Amperes	V_{CES} Volts (x 50)
CM	1400	24



Powerex, Inc., 173 Pavilion Lane, Youngwood, Pennsylvania 15697 (724) 925-7272 www.pwr.com

CM1400DUC-24NF
Mega Power Dual IGBTMOD™
1400 Amperes/1200 Volts

Absolute Maximum Ratings, $T_j = 25^\circ\text{C}$ unless otherwise specified

Ratings	Symbol	CM1400DUC-24NF	Units
Junction Temperature	T_j	-40 to 150	$^\circ\text{C}$
Storage Temperature	T_{stg}	-40 to 125	$^\circ\text{C}$
Collector-Emitter Voltage (G-E SHORT)	V_{CES}	1200	Volts
Gate-Emitter Voltage (C-E SHORT)	V_{GES}	± 20	Volts
Collector Current DC ($T_C = 94^\circ\text{C}$) ^{*1}	I_C	1400	Amperes
Peak Collector Current (Pulse, $T_j \leq 150^\circ\text{C}$) ^{*4}	I_{CM}	2800	Amperes
Emitter Current ($T_C = 25^\circ\text{C}$)	I_E ^{*3}	1400	Amperes
Peak Emitter Current (Pulse) ^{*4}	I_{EM} ^{*3}	2800	Amperes
Maximum Collector Dissipation ($T_j < 150^\circ\text{C}$, $T_C = 25^\circ\text{C}$) ^{*1}	P_C	8900	Watts
Mounting Torque, M6 Mounting Screws	–	40	in-lb (max.)
Mounting Torque, M6 Main Terminal Screw	–	40	in-lb (max.)
Weight (Typical)	–	1450	Grams
Isolation Voltage (Main Terminal to Baseplate, AC 1 min.)	V_{iso}	2500	Volts

*1 Case temperature T_C and heatsink temperature (T_f) measured point is just under the chips.

*3 I_E , I_{EM} , V_{EC} , I_{FSM} , I^2t , t_{rr} , Q_{rr} represent ratings and characteristics of the anti-parallel, emitter-to-collector free-wheel diode (FWDi).

*4 Pulse width and repetition rate should be such that device junction temperature (T_j) does not exceed $T_{j(max)}$ rating.

CM1400DUC-24NF
Mega Power Dual IGBTMOD™
 1400 Amperes/1200 Volts

Electrical Characteristics, $T_j = 25^\circ\text{C}$ unless otherwise specified

Characteristics	Symbol	Test Conditions	Min.	Typ.	Max.	Units
Collector-Cutoff Current	I_{CES}	$V_{CE} = V_{CES}, V_{GE} = 0V$	–	–	1	mA
Gate-Emitter Threshold Voltage	$V_{GE(th)}$	$I_C = 140mA, V_{CE} = 10V$	6	7	8	Volts
Gate Leakage Current	I_{GES}	$V_{GE} = V_{GES}, V_{CE} = 0V$	–	–	1.5	μA
Collector-Emitter Saturation Voltage (Chip)	$V_{CE(sat)}$	$I_C = 1400A, V_{GE} = 15V, T_j = 25^\circ\text{C}^{*6}$	–	1.8	2.5	Volts
(Without Lead Resistance)		$I_C = 1400A, V_{GE} = 15V, T_j = 125^\circ\text{C}^{*6}$	–	2.0	–	Volts
Module Lead Resistance	$R_{(lead)}$	$I_C = 1400A, \text{Terminal-Chip}$	–	0.286	–	m Ω
Input Capacitance	C_{ies}		–	–	220	nF
Output Capacitance	C_{oes}	$V_{CE} = 10V, V_{GE} = 0V$	–	–	25	nF
Reverse Transfer Capacitance	C_{res}		–	–	4.7	nF
Total Gate Charge	Q_G	$V_{CC} = 600V, I_C = 1400A, V_{GE} = 15V$	–	7200	–	nC
Inductive Turn-on Delay Time	$t_{d(on)}$	$V_{CC} = 600V, I_C = 1400A,$	–	–	800	ns
Load Rise Time	t_r	$V_{GE1} = V_{GE2} = 15V,$	–	–	300	ns
Switch Turn-off Delay Time	$t_{d(off)}$	$R_G = 0.22\Omega, \text{Inductive Load}$	–	–	1000	ns
Times Fall Time	t_f	Switching Operation	–	–	300	ns
Reverse Recovery Time	t_{rr}^{*3}	$I_E = 1400A$	–	–	700	ns
Reverse Recovery Charge	Q_{rr}^{*3}		–	90	–	μC
Emitter-Collector Voltage (Chip)	V_{EC}^{*3}	$I_E = 1400A, V_{GE} = 0V^{*6}$	–	–	3.2	Volts
(Without Lead resistance)						
External Gate Resistance	R_G		0.22	–	2.2	Ω

Thermal and Mechanical Characteristics, $T_j = 25^\circ\text{C}$ unless otherwise specified

Characteristics	Symbol	Test Conditions	Min.	Typ.	Max.	Units
Thermal Resistance, Junction to Case ^{*1}	$R_{th(j-c)Q}$	Per IGBT (1/2 Module)	–	–	0.014	$^\circ\text{C/W}$
Thermal Resistance, Junction to Case ^{*1}	$R_{th(j-c)D}$	Per Clamp Diode (1/2 Module)	–	–	0.023	$^\circ\text{C/W}$
Contact Thermal Resistance ^{*1}	$R_{th(c-f)}$	Thermal Grease Applied (1/2 Module)	–	0.012	–	$^\circ\text{C/W}$

*1 Case temperature T_C and heatsink temperature (T_f) measured point is just under the chips.

*3 $I_E, I_{EM}, V_{EC}, I_{FSM}, I^2t, t_{rr}, Q_{rr}$ represent ratings and characteristics of the anti-parallel, emitter-to-collector free-wheel diode (FWDi).

*6 Pulse width and repetition rate should be such as to cause negligible temperature rise.



CM1400DUC-24NF
Mega Power Dual IGBTMOD™
 1400 Amperes/1200 Volts

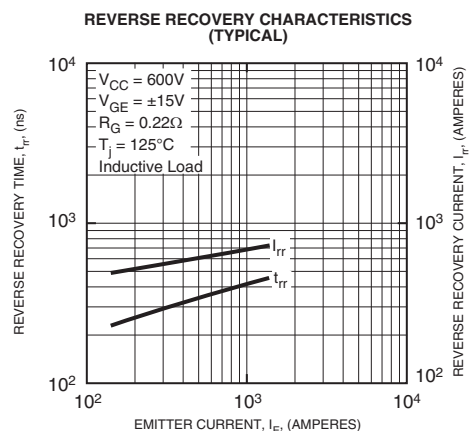
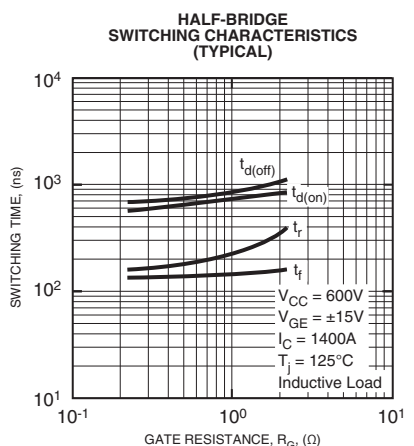
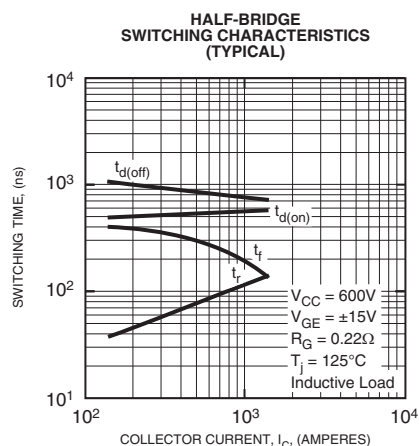
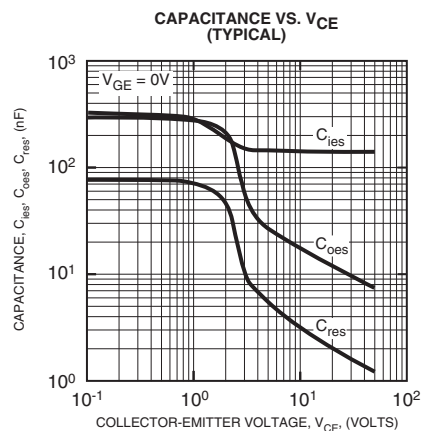
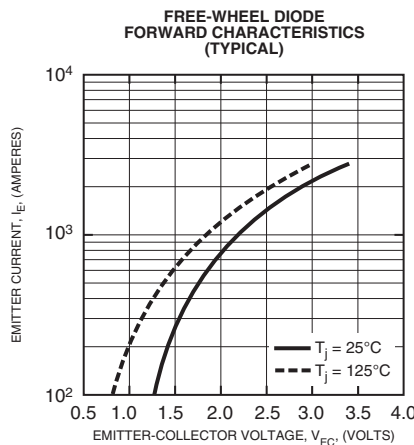
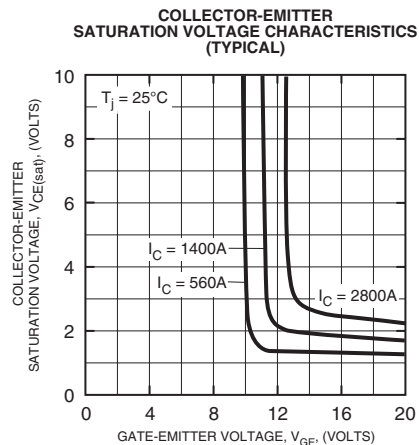
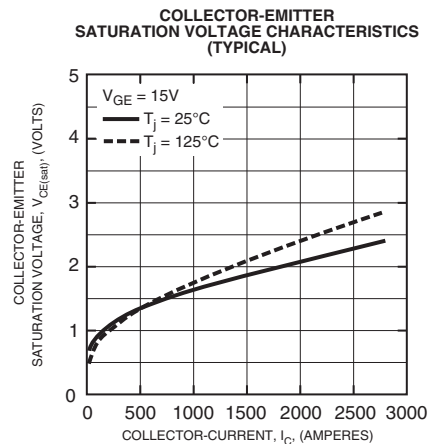
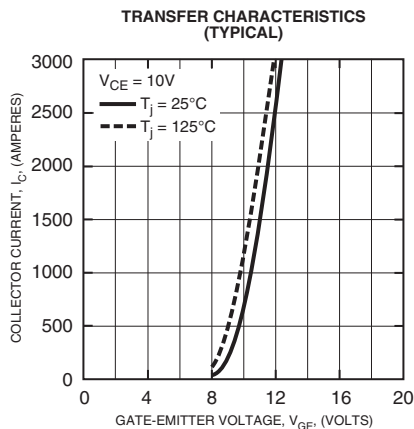
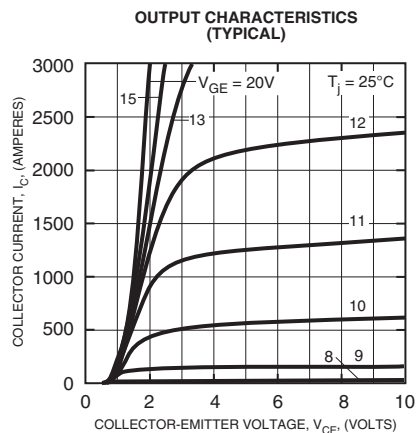



Powerex, Inc., 173 Pavilion Lane, Youngwood, Pennsylvania 15697 (724) 925-7272 www.pwr.com

CM1400DUC-24NF
Mega Power Dual IGBTMOD™
 1400 Amperes/1200 Volts

