

### NX-Series CIB Module (3Ø Converter + 3Ø Inverter + Brake) 75 Amperes/600 Volts

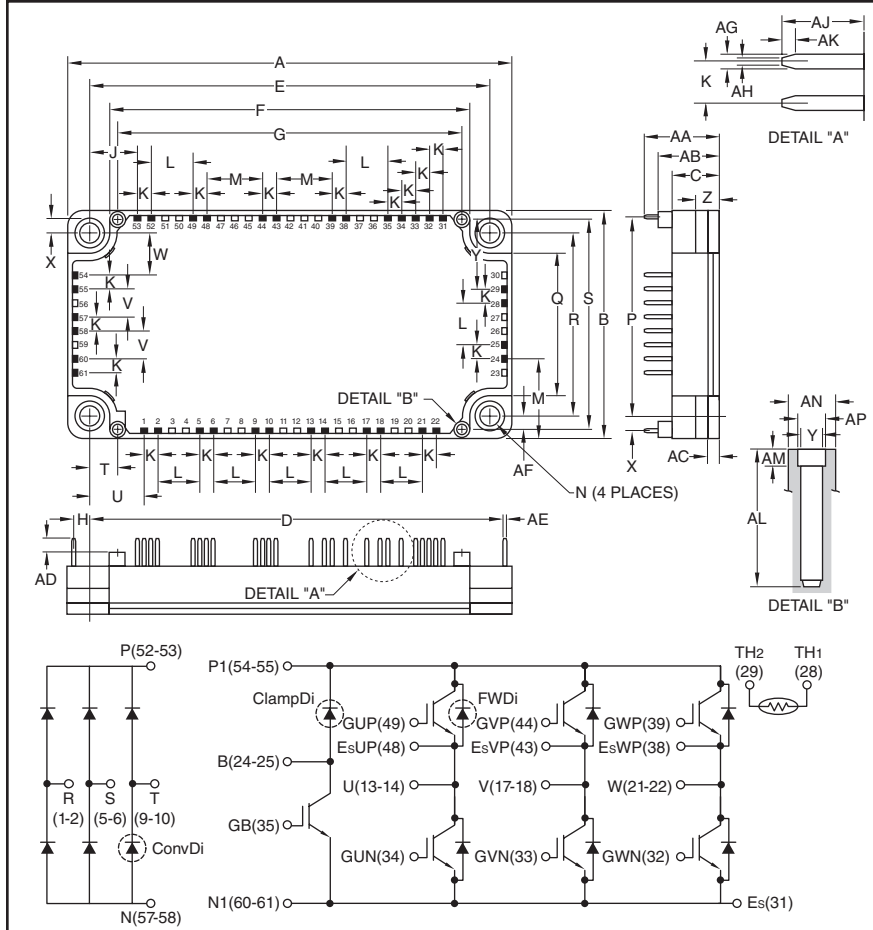

Outline Drawing and Circuit Diagram

Dimensions	Inches	Millimeters
A	4.79	121.7
B	2.44	62.0
C	0.51	13.0
D	4.49	114.05
E	4.33±0.02	110.0±0.5
F	3.89	99.0
G	3.72	94.5
H	0.16	4.06
J	0.51	13.09
K	0.15	3.81
L	0.45	11.43
M	0.6	15.24
N	0.22 Dia.	5.5 Dia.
P	2.13	54.2
Q	1.53	39.0
R	1.97±0.02	50.0±0.5
S	2.26	57.5
T	0.30	7.75
U	0.59	15.0

Dimensions	Inches	Millimeters
V	0.3	7.62
W	0.46	11.66
X	0.16	4.2
Y	0.08 Dia.	2.1 Dia.
Z	0.27	7.0
AA	0.81	20.5
AB	0.67	17.0
AC	0.12	3.0
AD	0.14	3.5
AE	0.03	0.8
AF	0.15	3.75
AG	0.05	1.15
AH	0.025	0.65
AJ	0.29	7.4
AK	0.047	1.2
AL	0.49	12.5
AM	0.06	1.5
AN	0.17 Dia.	4.3 Dia.
AP	0.10 Dia.	2.5 Dia.



#### Description:

CIBs are low profile and thermally efficient. Each module consists of a three-phase diode converter section, a three-phase inverter section and a brake circuit. A thermistor is included in the package for sensing the baseplate temperature. 5th Generation CSTBT chips yield low loss.

#### Features:

- Low Drive Power
- Low  $V_{CE(sat)}$
- Discrete Super-Fast Recovery Free-Wheel Diode
- Isolated Baseplate for Easy Heat Sinking

#### Applications:

- AC Motor Control
- Motion/Servo Control
- Photovoltaic/Fuel Cell

#### Ordering Information:

Example: Select the complete module number you desire from the table below -i.e. CM75MX-12A is a 600V ( $V_{CES}$ ), 75 Ampere CIB Power Module.

Type	Current Rating Amperes	$V_{CES}$ Volts (x 50)
CM	75	12

**CM75MX-12A**  
**NX-Series CIB Module**  
**(3Ø Converter + 3Ø Inverter + Brake)**  
 75 Amperes/600 Volts

**Absolute Maximum Ratings, T<sub>j</sub> = 25°C unless otherwise specified**

Characteristics	Symbol	CM75MX-12A	Units
<b>Inverter Part IGBT/FWDi</b>			
Collector-Emitter Voltage (G-E Short)	V <sub>CES</sub>	600	Volts
Gate-Emitter Voltage (C-E Short)	V <sub>GES</sub>	±20	Volts
Collector Current (DC, T <sub>C</sub> = 70°C) <sup>*2,*4</sup>	I <sub>C</sub>	75	Amperes
Collector Current (Pulse) <sup>*3</sup>	I <sub>CRM</sub>	150	Amperes
Total Power Dissipation (T <sub>C</sub> = 25°C) <sup>*2,*4</sup>	P <sub>tot</sub>	280	Watts
Emitter Current <sup>*2</sup>	I <sub>E</sub> <sup>*1</sup>	75	Amperes
Emitter Current (Pulse) <sup>*3</sup>	I <sub>ERM</sub> <sup>*1</sup>	150	Amperes

**Brake Part IGBT/ClampDi**

Collector-Emitter Voltage (G-E Short)	V <sub>CES</sub>	600	Volts
Gate-Emitter Voltage (C-E Short)	V <sub>GES</sub>	±20	Volts
Collector Current (DC, T <sub>C</sub> = 97°C) <sup>*2,*4</sup>	I <sub>C</sub>	50	Amperes
Collector Current (Pulse) <sup>*3</sup>	I <sub>CRM</sub>	100	Amperes
Total Power Dissipation (T <sub>C</sub> = 25°C) <sup>*2,*4</sup>	P <sub>tot</sub>	280	Watts
Repetitive Peak Reverse Voltage	V <sub>RPM</sub>	600	Volts
Forward Current (T <sub>C</sub> = 25°C) <sup>*2</sup>	I <sub>F</sub>	50	Amperes
Forward Current (Pulse) <sup>*3</sup>	I <sub>FRM</sub>	100	Amperes

**Converter Part ConvDi**

Repetitive Peak Reverse Voltage	V <sub>RPM</sub>	800	Volts
Recommended AC Input Voltage	E <sub>a</sub>	220	Volts
DC Output Current (3-Phase Full Wave Rectifying, f = 60Hz, T <sub>C</sub> = 125°C) <sup>*2,*4</sup>	I <sub>O</sub>	75	Amperes
Surge Forward Current (Sine Half-wave 1 Cycle Peak Value, f = 60Hz, Non-repetitive)	I <sub>FSM</sub>	750	Amperes
Current Square Time (Value for One Cycle of Surge Current)	I <sup>2</sup> t	2340	A <sup>2</sup> s

**Module**

Isolation Voltage (Charged Part to Baseplate, RMS, f = 60Hz, AC 1 min.)	V <sub>ISO</sub>	2500	Volts
Junction Temperature	T <sub>j</sub>	-40 ~ +150	°C
Storage Temperature	T <sub>stg</sub>	-40 ~ +125	°C

\*1 Represent ratings and characteristics of the anti-parallel, emitter-to-collector free wheeling diode (FWDi).  
 \*2 Junction temperature (T<sub>j</sub>) should not increase beyond maximum junction temperature (T<sub>j(max)</sub>) rating.  
 \*3 Pulse width and repetition rate should be such that device junction temperature (T<sub>j</sub>) does not exceed T<sub>j(max)</sub> rating.  
 \*4 Case temperature (T<sub>C</sub>) and heatsink temperature (T<sub>S</sub>) is measured on the surface (mounting side) of the baseplate and the heatsink side just under the chips. Refer to the figure to the right for chip location.  
 The heatsink thermal resistance should be measured just under the chips.

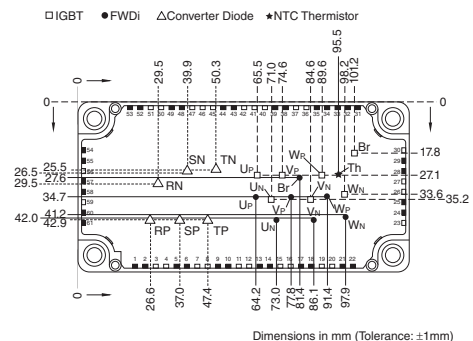

**CM75MX-12A**  
**NX-Series CIB Module**  
**(3Ø Converter + 3Ø Inverter + Brake)**  
 75 Amperes/600 Volts

## Electrical Characteristics, $T_j = 25^\circ\text{C}$ unless otherwise specified

### Inverter Part IGBT/FWDi

Characteristics	Symbol	Test Conditions	Min.	Typ.	Max.	Units	
Collector Cutoff Current	$I_{CES}$	$V_{CE} = V_{CES}, V_{GE} = 0V$	—	—	1.0	mA	
Gate Leakage Current	$I_{GES}$	$V_{GE} = V_{GES}, V_{CE} = 0V$	—	—	0.5	$\mu\text{A}$	
Gate-Emitter Threshold Voltage	$V_{GE(th)}$	$I_C = 7.5\text{mA}, V_{CE} = 10V$	5	6	7	Volts	
Collector-Emitter Saturation Voltage	$V_{CE(sat)}$	$T_j = 25^\circ\text{C}, I_C = 75\text{A}, V_{GE} = 15V^{*5}$	—	1.7	2.1	Volts	
		$T_j = 125^\circ\text{C}, I_C = 75\text{A}, V_{GE} = 15V^{*5}$	—	1.9	—	Volts	
		$I_C = 75\text{A}, V_{GE} = 15V, \text{Chip}^{*5}$	—	1.6	—	Volts	
Input Capacitance	$C_{ies}$		—	—	7.5	nF	
Output Capacitance	$C_{oes}$	$V_{CE} = 10V, V_{GE} = 0V$	—	—	1.0	nF	
Reverse Transfer Capacitance	$C_{res}$		—	—	0.3	nF	
Total Gate Charge	$Q_G$	$V_{CC} = 300V, I_C = 75\text{A}, V_{GE} = 15V$	—	200	—	nC	
Inductive Load Switch Time	Turn-on Delay Time	$t_{d(on)}$	—	—	100	ns	
	Turn-on Rise Time	$t_r$	$V_{CC} = 300V, I_C = 75\text{A}, V_{GE} = \pm 15V,$	—	—	100	ns
	Turn-off Delay Time	$t_{d(off)}$	$R_G = 8.2\Omega, \text{Inductive Load}$	—	—	300	ns
	Turn-off Fall Time	$t_f$		—	—	600	ns
Emitter-Collector Voltage	$V_{EC}^{*1}$	$T_j = 25^\circ\text{C}, I_E = 75\text{A}, V_{GE} = 0V^{*5}$	—	2.0	2.8	Volts	
		$T_j = 125^\circ\text{C}, I_E = 75\text{A}, V_{GE} = 0V^{*5}$	—	1.95	—	Volts	
		$I_E = 75\text{A}, V_{GE} = 0V, \text{Chip}$	—	1.9	—	Volts	
Reverse Recovery Time	$t_{rr}^{*1}$	$V_{CC} = 300V, I_E = 75\text{A}, V_{GE} = \pm 15V$	—	—	200	ns	
Reverse Recovery Charge	$Q_{rr}^{*1}$	$R_G = 8.2\Omega, \text{Inductive Load}$	—	1.8	—	$\mu\text{C}$	
Internal Gate Resistance	$r_g$	$T_C = 25^\circ\text{C}, \text{Per Switch}$	—	0	—	$\Omega$	
External Gate Resistance	$R_G$		8.0	—	83	$\Omega$	

\*1 Represent ratings and characteristics of the anti-parallel, emitter-to-collector free wheeling diode (FWDi).

\*5 Pulse width and repetition rate should be such as to cause negligible temperature rise.

**CM75MX-12A**  
**NX-Series CIB Module**  
**(3Ø Converter + 3Ø Inverter + Brake)**  
 75 Amperes/600 Volts

**Electrical Characteristics, T<sub>j</sub> = 25°C unless otherwise specified**

Characteristics	Symbol	Test Conditions	Min.	Typ.	Max.	Units
<b>Brake Part IGBT/ClampDi</b>						
Collector Cutoff Current	I <sub>CES</sub>	V <sub>CE</sub> = V <sub>CES</sub> , V <sub>GE</sub> = 0V	—	—	1.0	mA
Gate Leakage Current	I <sub>GES</sub>	V <sub>GE</sub> = V <sub>GES</sub> , V <sub>CE</sub> = 0V	—	—	0.5	µA
Gate-Emitter Threshold Voltage	V <sub>GE(th)</sub>	I <sub>C</sub> = 5mA, V <sub>CE</sub> = 0V	5	6	7	Volts
Collector-Emitter Saturation Voltage	V <sub>CE(sat)</sub>	T <sub>j</sub> = 25°C, I <sub>C</sub> = 50A, V <sub>GE</sub> = 15V <sup>5</sup>	—	1.7	2.1	Volts
		T <sub>j</sub> = 125°C, I <sub>C</sub> = 50A, V <sub>GE</sub> = 15V <sup>5</sup>	—	1.9	—	Volts
		I <sub>C</sub> = 50A, V <sub>GE</sub> = 15V, Chip	—	1.6	—	Volts
Input Capacitance	C <sub>ies</sub>		—	—	9.3	nF
Output Capacitance	C <sub>oes</sub>	V <sub>CE</sub> = 10V, V <sub>GE</sub> = 0V	—	—	1.0	nF
Reverse Transfer Capacitance	C <sub>res</sub>		—	—	0.3	nF
Total Gate Charge	Q <sub>G</sub>	V <sub>CC</sub> = 300V, I <sub>C</sub> = 50A, V <sub>GE</sub> = 15V	—	200	—	nC
Internal Gate Resistance	r <sub>g</sub>	T <sub>C</sub> = 25°C	—	0	—	Ω
Repetitive Reverse Current	I <sub>RRM</sub>	V <sub>R</sub> = V <sub>RRM</sub>	—	—	1.0	mA
Forward Voltage Drop	V <sub>F</sub>	T <sub>j</sub> = 25°C, I <sub>F</sub> = 50A <sup>5</sup>	—	2.0	2.8	Volts
		T <sub>j</sub> = 125°C, I <sub>F</sub> = 50A <sup>5</sup>	—	1.95	—	Volts
		I <sub>F</sub> = 50A, Chip	—	1.9	—	Volts
External Gate Resistance	R <sub>G</sub>		13	—	125	Ω

**Converter Part**

Repetitive Peak Reverse Current	I <sub>RRM</sub>	V <sub>R</sub> = V <sub>RRM</sub> , T <sub>j</sub> = 150°C	—	—	20	mA
Forward Voltage Drop	V <sub>F</sub>	I <sub>F</sub> = 75A <sup>5</sup>	—	1.2	1.6	Volts

**NTC Thermistor Part**

Zero Power Resistance	R <sub>25</sub>	T <sub>C</sub> = 25°C <sup>4</sup>	4.85	5.00	5.15	kΩ
Deviation of Resistance	ΔR/R	R <sub>100</sub> = 493Ω, T <sub>C</sub> = 100°C <sup>4</sup>	-7.3	—	+7.8	%
B Constant	B <sub>(25/50)</sub>	Approximate by Equation <sup>6</sup>	—	3375	—	K
Power Dissipation	P <sub>25</sub>	T <sub>C</sub> = 25°C <sup>4</sup>	—	—	10	mW

<sup>4</sup> Case temperature (T<sub>C</sub>) and heatsink temperature (T<sub>S</sub>) is measured on the surface (mounting side) of the baseplate and the heatsink side just under the chips. Refer to the figure to the right for chip location. The heatsink thermal resistance should be measured just under the chips.

<sup>5</sup> Pulse width and repetition rate should be such as to cause negligible temperature rise.

$$^6 B_{(25/50)} = \ln\left(\frac{R_{25}}{R_{50}}\right) / \left(\frac{1}{T_{25}} - \frac{1}{T_{50}}\right)$$

R<sub>25</sub>: Resistance at Absolute Temperature T<sub>25</sub> [K]; T<sub>25</sub> = 25 [°C] + 273.15 = 298.15 [K]  
 R<sub>50</sub>: Resistance at Absolute Temperature T<sub>50</sub> [K]; T<sub>50</sub> = 50 [°C] + 273.15 = 323.15 [K]

□ IGBT ● FWDI △ Converter Diode ★ NTC Thermistor

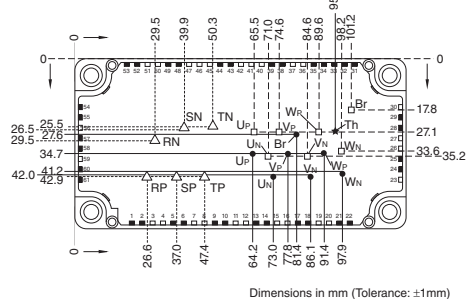

**CM75MX-12A**  
**NX-Series CIB Module**  
**(3Ø Converter + 3Ø Inverter + Brake)**  
 75 Amperes/600 Volts

## Thermal Resistance Characteristics, $T_j = 25^\circ\text{C}$ unless otherwise specified

Characteristics	Symbol	Test Conditions	Min.	Typ.	Max.	Units
Thermal Resistance, Junction to Case	$R_{th(j-c)Q}$	Per Inverter IGBT <sup>*4</sup>	—	—	0.44	$^\circ\text{C/W}$
Thermal Resistance, Junction to Case	$R_{th(j-c)D}$	Per Inverter FWDi <sup>*4</sup>	—	—	0.85	$^\circ\text{C/W}$
Thermal Resistance, Junction to Case	$R_{th(j-c)Q}$	Brake IGBT <sup>*4</sup>	—	—	0.44	$^\circ\text{C/W}$
Thermal Resistance, Junction to Case	$R_{th(j-c)D}$	Brake ClampDi <sup>*4</sup>	—	—	0.85	$^\circ\text{C/W}$
Thermal Resistance, Junction to Case	$R_{th(j-c)D}$	Per ConvDi <sup>*4</sup>	—	—	0.24	$^\circ\text{C/W}$
Contact Thermal Resistance	$R_{th(c-s)}$	Case to Heatsink, Per 1 Module Thermal Grease Applied <sup>*4, *7</sup>	—	0.015	—	$^\circ\text{C/W}$

## Mechanical Characteristics

Characteristics	Symbol	Test Conditions	Min.	Typ.	Max.	Units
Mounting Torque, M5 Mounting Screws	—	—	—	31	—	in-lb
Module Weight (Typical)	—	—	—	270	—	Grams
Isolation Voltage, (Charged Part to Baseplate, RMS, f = 60Hz, AC 1 min.)	$V_{ISO}$	—	—	2500	—	Volts
Flatness of Baseplate <sup>*8</sup>	$e_c$	—	—	$\pm 0$ to +100	—	$\mu\text{m}$

<sup>\*4</sup> Case temperature ( $T_C$ ) and heatsink temperature ( $T_S$ ) is measured on the surface (mounting side) of the baseplate and the heatsink side just under the chips. Refer to the figure to the right for chip location.

The heatsink thermal resistance should be measured just under the chips.

<sup>\*7</sup> Typical value is measured by using thermally conductive grease of  $\lambda = 0.9 \text{ [W/(m} \cdot \text{K)]}$ .

<sup>\*8</sup> Baseplate (mounting side) flatness measurement points (X, Y) are shown in the figure below.

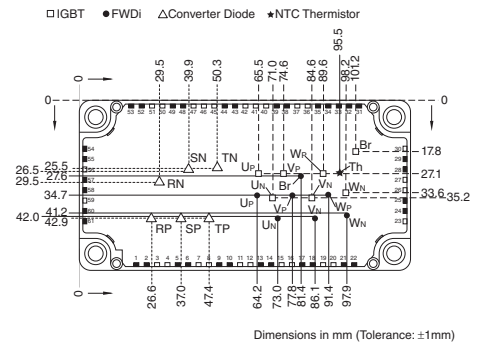
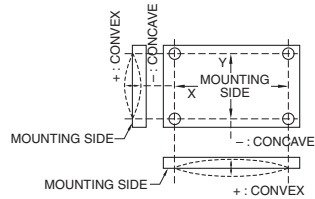

**CM75MX-12A**  
**NX-Series CIB Module**  
**(3Ø Converter + 3Ø Inverter + Brake)**  
**75 Amperes/600 Volts**

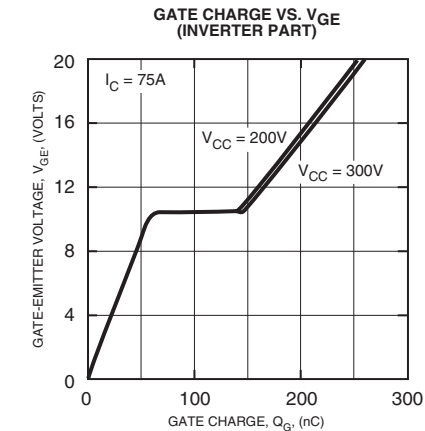
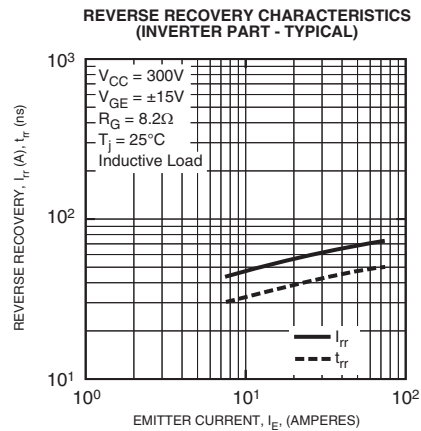
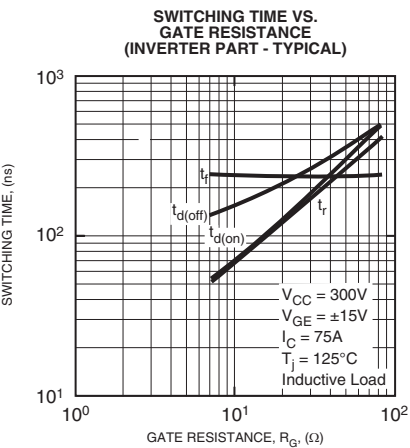
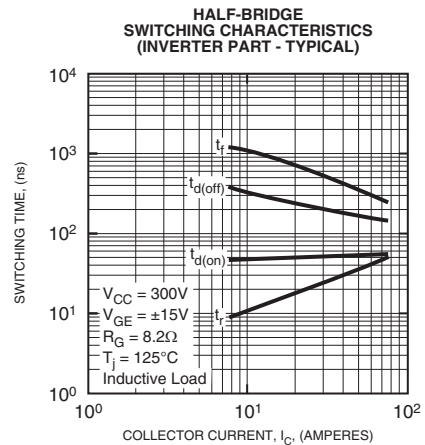
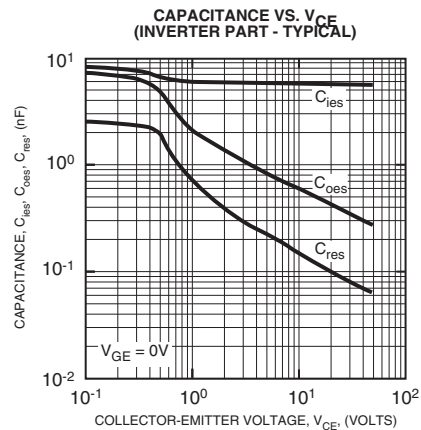
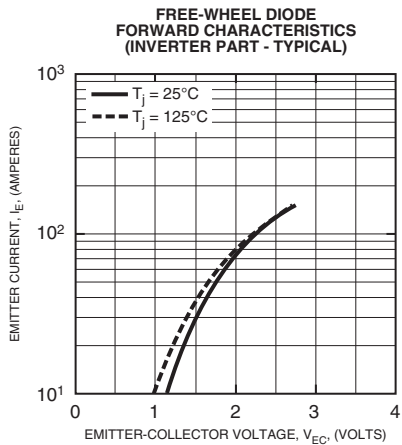
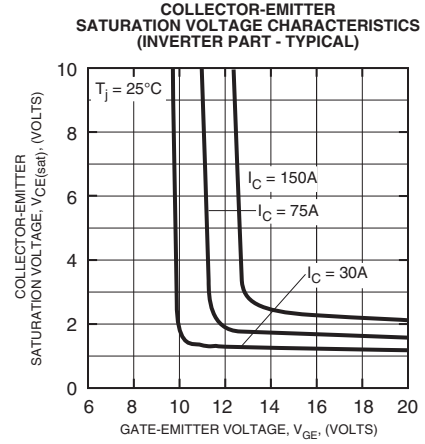
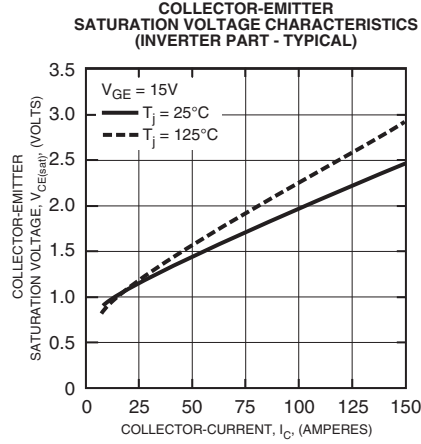
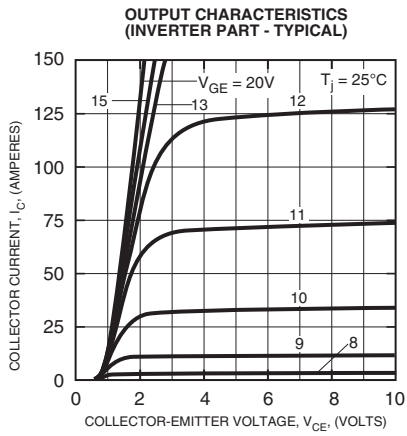

**CM75MX-12A**  
**NX-Series CIB Module**  
**(3Ø Converter + 3Ø Inverter + Brake)**  
**75 Amperes/600 Volts**

