

# ***Model 6010***

***GAUSS / TESLA METER***

## **Instruction Manual**

Manual UN-01-247  
Item 359933  
July, 1999  
Rev. C  
© Bell Technologies Inc.  
All rights reserved.





*This symbol appears on the instrument and probe. It refers the operator to additional information contained in this instruction manual, also identified by the same symbol.*

## **NOTICE:**

**See Pages 3-1 and 3-2  
for SAFETY  
instructions prior to first use !**

# ***Table of Contents***

## **SECTION-1 INTRODUCTION**

Understanding Flux Density.....	1-1
Measurement of Flux Density.....	1-2
Product Description.....	1-5
Applications.....	1-7

## **SECTION-2 SPECIFICATIONS**

Instrument.....	2-1
Zero Flux Chamber.....	2-5

## **SECTION-3 OPERATING INSTRUCTIONS**

Safety Instructions.....	3-1
General Description.....	3-3
Instrument Preparation.....	3-5
Power-Up.....	3-5
Power-Up Settings.....	3-7
Low Battery Condition.....	3-7
Overrange Condition.....	3-8
AC or DC Measurement Selection.....	3-9
UNITS of Measurement Selection.....	3-10
RANGE Selection.....	3-12
HOLD Mode Selection.....	3-13
MIN, MAX, PEAK HOLD Usage.....	3-15
FAST PEAK HOLD Usage.....	3-16
ZERO Function.....	3-17
Automatic ZERO Function.....	3-19
Manual ZERO Function.....	3-21
RELATIVE Mode.....	3-21
Automatic RELATIVE Mode.....	3-23
Manual RELATIVE Mode.....	3-24
ANALOG OUTPUT.....	3-24
Analog Output Usage.....	3-25

Sources of Measurement Errors.....	3-26
More details on AC Mode Operation.....	3-29
More details on DC Mode Operation.....	3-31
Temperature effects .....	3-31

**SECTION-4 REMOTE OPERATION**

RS-232 Interface Parameters.....	4-1
RS-232 Interface Connection.....	4-1
Remote Command Standards.....	4-3
Command Format.....	4-4
Message Terminators.....	4-4
Error Buffer.....	4-5
Status Registers.....	4-5
Status Byte and Request For Service (RQS).....	4-6
Standard Event Register.....	4-9
Measurement Event Register.....	4-10
Operation Event Register.....	4-10
Questionable Event Register.....	4-11
“Common” Command Syntax.....	4-11
“Common” Commands.....	4-13
SCPI Command Syntax.....	4-16
SCPI Commands.....	4-18
Error Messages and Commands.....	4-21
Status Commands.....	4-23
UNITS Commands.....	4-25
RANGE Commands.....	4-27
HOLD Commands.....	4-28
ZERO Command.....	4-29
RELATIVE Commands.....	4-29
MEASUREMENT Commands.....	4-30
DISPLAY FORMAT Commands.....	4-31
Intermixing Common and SCPI commands.....	4-32
Using Query Commands.....	4-32
Using the Operation Complete Status.....	4-33
Example Program.....	4-34

<b>WARRANTY</b> .....	5-1
-----------------------	-----

## *List of Tables*

Table 4-1	Common Command Summary.....	4-13
Table 4-2	SCPI Command Summary.....	4-18

## *List of Illustrations*

Figure 1-1	Flux Lines of a Permanent Magnet.....	1-1
Figure 1-2	Hall Generator.....	1-3
Figure 1-3	Hall Probe Configurations.....	1-4
Figure 2-1	Zero Flux Chamber.....	2-5
Figure 3-1	Probe Electrical Warning.....	3-2
Figure 3-2	Front Panel .....	3-3
Figure 3-3	Rear Panel.....	3-4
Figure 3-4	Power-Up Display.....	3-5
Figure 3-5	Missing Probe Indication.....	3-6
Figure 3-6	Low Battery Indication.....	3-8
Figure 3-7	Overrange Indication .....	3-9
Figure 3-8	The legends for UNIT Function.....	3-11
Figure 3-9	HOLD Function.....	3-14
Figure 3-10	FAST PEAK HOLD.....	3-15
Figure 3-11	Probe zeroing error code .....	3-20
Figure 3-12	Adjusting the DC Offset of the Analog Output.....	3-26
Figure 3-13	Probe Output versus Flux Angle.....	3-27
Figure 3-14	Probe Output versus Distance.....	3-28
Figure 3-15	Flux Density Variations in a Magnet.....	3-28
Figure 3-16	Low AC Signal Indication.....	3-30

Figure 4-1 9-Pin Interface Connector..... 4-2  
Figure 4-2 Serial Port Connection Schemes..... 4-3  
Figure 4-3 Condition, Event and Enable registers..... 4-6  
Figure 4-4 Status Byte and Enable registers..... 4-7  
Figure 4-5 Standard Event register..... 4-9  
Figure 4-6 Measurement Event register..... 4-10  
Figure 4-7 Operation Event register..... 4-10  
Figure 4-8 Questionable Event register..... 4-11

# Section 1

## Introduction

### UNDERSTANDING FLUX DENSITY:

Magnetic fields surrounding permanent magnets or electrical conductors can be visualized as a collection of magnetic *flux* lines; lines of force existing in the material that is being subjected to a magnetizing influence. Unlike light, which travels away from its source indefinitely, magnetic flux lines must eventually return to the source. Thus all magnetic sources are said to have two *poles*. Flux lines are said to emanate from the “north” pole and return to the “south” pole, as depicted in Figure 1-1.

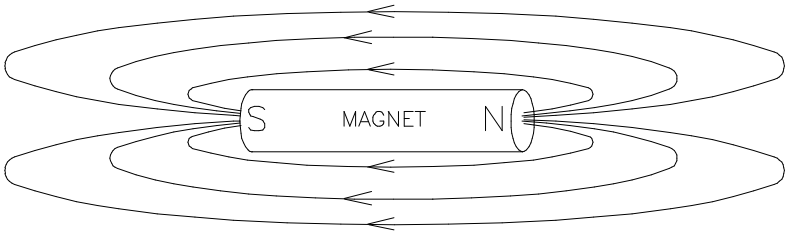

Figure 1-1  
Flux Lines of a Permanent Magnet

One line of flux in the cgs measurement system is called a *maxwell* (Mx), but the *weber* (Wb), which is  $10^8$  lines, is more commonly used.

Flux density, also called magnetic induction, is the number of flux lines passing through a given area. It is commonly assigned the symbol “*B*” in scientific documents. In the cgs system a *gauss* (G) is one line of flux passing through a  $1 \text{ cm}^2$  area. The more

## INTRODUCTION

commonly used term is the *tesla* (T), which is 10,000 lines per  $\text{cm}^2$ . Thus

$$1 \text{ tesla} = 10,000 \text{ gauss}$$

$$1 \text{ gauss} = 0.0001 \text{ tesla}$$

Magnetic field strength is a measure of force produced by an electric current or a permanent magnet. It is the ability to induce a magnetic field "*B*". It is commonly assigned the symbol "*H*" in scientific documents. The unit of "*H*" in the cgs system is an *oersted* (Oe), but the *ampere/meter* (A/m) is more commonly used. The relationship is

$$1 \text{ oersted} = 79.6 \text{ ampere/meter}$$

$$1 \text{ ampere/meter} = 0.01256 \text{ oersted}$$

It is important to know that magnetic field strength and magnetic flux density are not the same. The only time the two are considered equal is in free space. Only in free space is the following relationship true:

$$1 \text{ G} = 1 \text{ Oe} = 0.0001 \text{ T} = 79.6 \text{ A/m}$$

## MEASUREMENT OF FLUX DENSITY:

A device commonly used to measure flux density is the *Hall generator*. A Hall generator is a thin slice of a semiconductor material to which four leads are attached at the midpoint of each edge, as shown in Figure 1-2.



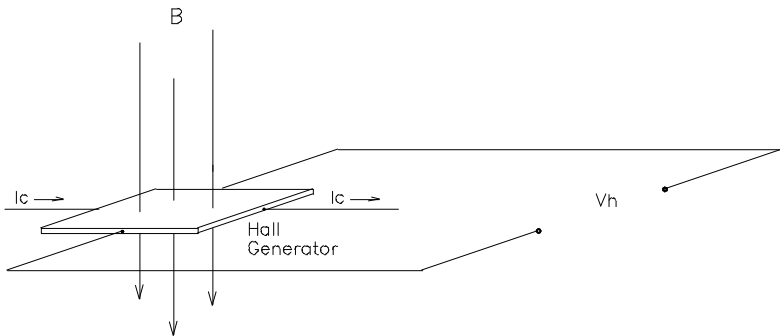

Figure 1-2  
Hall Generator

A constant current ( $I_c$ ) is forced through the material. In a zero magnetic field there is no voltage difference between the other two edges. When flux lines pass through the material the path of the current bends closer to one edge, creating a voltage difference known as the Hall voltage ( $V_h$ ). In an ideal Hall generator there is a linear relationship between the number of flux lines passing through the material (flux density) and the Hall voltage.

The Hall voltage is also a function of the *direction* in which the flux lines pass through the material, producing a positive voltage in one direction and a negative voltage in the other. If the same number of flux lines pass through the material in either direction, the net result is zero volts. This sensitivity to flux direction makes it possible to measure both static (dc) and alternating (ac) magnetic fields.

The Hall voltage is also a function of the *angle* at which the flux lines pass through the material. The greatest Hall voltage occurs when the flux lines pass perpendicularly through the material. Otherwise the output is related to the cosine of the difference between  $90^\circ$  and the actual angle.

## INTRODUCTION

The sensitive area of the Hall generator is generally defined as the largest circular area within the actual slice of the material. This *active area* can range in size from 0.2 mm (0.008") to 19 mm (0.75") in diameter. Often the Hall generator assembly is too fragile to use by itself so it is often mounted in a protective tube and terminated with a flexible cable and a connector. This assembly, known as a *Hall probe*, is generally provided in two configurations:

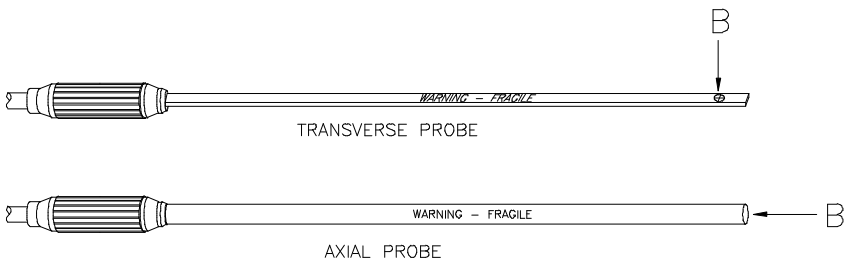

Figure 1-3  
Hall Probe Configurations

In “transverse” probes the Hall generator is mounted in a thin, flat stem whereas in “axial” probes the Hall generator is mounted in a cylindrical stem. The axis of sensitivity is the primary difference, as shown by “B” in Figure 1-3. Generally transverse probes are used to make measurements between two magnetic poles such as those in audio speakers, electric motors and imaging machines. Axial probes are often used to measure the magnetic field along the axis of a coil or solenoid. Either probe can be used where there are few physical space limitations, such as in geomagnetic or electromagnetic interference surveys.



***Handle the Hall probe with care. Do not bend the stem or apply pressure to the probe tip as damage may result.***

### PRODUCT DESCRIPTION:

The *MODEL 6010 GAUSS / TESLAMETER* is a portable instrument that accepts detachable Hall probes to measure magnetic flux density in terms of gauss, tesla or ampere per meter. The measurement range is from 0.1  $\mu\text{T}$  (1 mG or 0.1 A/m) to 29.99T (299.9 kG or 23.87 MA/m), depending upon the type of probe that is used. The instrument is capable of measuring static (dc) magnetic fields and alternating (ac) fields.

*NOTE: Although ampere per meter is a measure of magnetic field strength, in free space there is a direct relationship between flux density and field strength. When using a Hall probe there will always be an air gap between the probe and the magnetic source. Refer to the relationship given on page 1-2*

When an appropriate probe is used, the instrument can compensate for errors due to probe temperature variations. The instrument features a large display that is visible at considerable distances. A dual readout allows you to measure flux density and monitor an auxiliary function such as temperature or the present flux density during the Peak, Max or Min hold measurements. The meter can be operated from standard line voltages and contains a rechargeable battery for hours of portable operation.

Three measurement ranges can be selected or the instrument can automatically select the best range based on the present flux density being measured. A “zero” function allows the user to remove undesirable readings from nearby magnetic fields (including earth’s) or false readings caused by initial electrical offsets in the probe and meter. Included is a “zero flux chamber” which shields the probe from external magnetic fields during this operation. Another feature, called “relative mode”, allows large flux readings to be suppressed so that small variations within the

## INTRODUCTION

larger field can be observed directly. Both the “zero” and “relative” adjustments can be made manually or automatically.

Other features include four “hold” modes, allowing either the arithmetic maximum, minimum, peak or true peak values to be held indefinitely until reset by the user. An analog signal is available from a standard BNC connector that is representative of the magnetic flux density signal and is calibrated to  $\pm 3$  volts full scale in dc mode or 3 Vrms in ac mode. This output can be connected to a voltmeter, oscilloscope, recorder or external analog-to-digital converter. An optional adapter allows the 6010 to accept probes designed for F. W. Bell’s model 9200 Gaussmeter.

The meter can be fully configured and flux density readings acquired from a remote computer or PLC using the RS-232 communications port. This is a standard 9-pin “D” connector commonly used in personal computers. The commands follow widely accepted protocols established by the IEEE-488.2 and SCPI-1991 standards.

The probes and accessories are protected when not in use by a sturdy carrying case.

### APPLICATIONS:

- Sorting or performing incoming inspection on permanent magnets, particularly multi-pole magnets.
- Testing audio speaker magnet assemblies, electric motor armatures and stators, transformer lamination stacks, cut toroidal cores, coils and solenoids.
- Determining the location of stray fields around medical diagnostic equipment.
- Determining sources of electromagnetic interference.
- Locating flaws in welded joints.
- Inspection of ferrous materials.
- 3-dimensional field mapping.
- Inspection of magnetic recording heads.



# Section 2

# Specifications

## INSTRUMENT

RANGE			RESOLUTION		
gauss	tesla	A/m	gauss	tesla	A/m
* 3 G	300 $\mu$ T	238.8 A/m	0.001 G	0.1 $\mu$ T	0.1 A/m
* 30G	3 mT	2.388 kA/m	0.01 G	0.001mT	0.001kA/m
300G	30mT	23.88 kA/m	0.1 G	0.01mT	0.01 kA/m
3 kG	300 mT	238.8 kA/m	1 G	0.1 mT	0.1 kA/m
30 kG	3 T	2.388MA/m	0.01 kG	0.001 T	1 kA/m
** 300 kG	30 T	23.88MA/m	0.1 kG	0.01 T	0.01MA/m

\* When used with high sensitivity probes

\*\* When used with high stability probes.

### ACCURACY (reading on display and from RS-232 port)

dc mode:  $\pm 0.25$  % of reading,  $\pm 3$  counts

ac mode:

20 Hz - 1000 Hz:  $\pm 1$  % of reading,  $\pm 3$  counts

1 kHz - 20kHz  $\pm 5$  % of reading,  $\pm 3$  counts

### ACCURACY (analog output)

dc mode:  $\pm 1$  % of reading,  $\pm 5$  mV.

ac mode:

20 Hz - 1000 Hz:  $\pm 2$  % of reading,  $\pm 5$  mV

### WARMUP TIME TO RATED

ACCURACY: 15 minutes

## SPECIFICATIONS

### MIN / MAX HOLD ACQUISITION TIME:

dc mode:	180 ms typical
ac mode:	300 ms typical

### PEAK HOLD ACQUISITION TIME:

dc mode:	180 ms typical
ac mode:	300 ms typical

### PEAK HOLD (FAST) ACQUISITION TIME:

dc mode:	1 ms typical
ac mode:	1 ms typical

### ANALOG OUTPUT SCALING:

dc mode:	$\pm 3$ Vdc
ac mode:	3 Vrms

### ANALOG OUTPUT NOISE:

4 mVrms typical

### ANALOG OUTPUT LOAD:

10 kohm min, 100 pF max.

### ACCURACY CHANGE WITH TEMPERATURE

$\pm 0.02$  % / °C typical

### ANALOG OUTPUT CONNECTOR:

BNC

### TEMPERATURE MEASUREMENT

Range:	-40°C to +100°C (-40°F to +212°F)
Accuracy:	$\pm 1$ °C ( $\pm 1$ °F)

Analog Output	10 mV/°C (10mV/°F)
---------------	--------------------

### OPERATING TEMPERATURE:

0 to +50°C (+32 to +122°F)

### STORAGE TEMPERATURE:

-25 to +70°C (-13 to +158°F)

### INPUT VOLTAGE:

100 to 240 Vac, 50/60 Hz



## SPECIFICATIONS

**INTERNAL BATTERY :** Rechargeable Sealed  
Lead Acid

**BATTERY LIFE:** 8 hours typical  
(Time between charges)

### METER DIMENSIONS:

**Length:** 31.75cm (12.5 in)  
**Width:** 25.4 cm (10 in)  
**Height:** 11.43 cm (4.5 in)

### WEIGHT:

**Instrument:** 4.0 kg (8.8 lbs.)  
**Shipping:** 6.2 kg (13.7 lbs)

### REGULATORY INFORMATION:

Compliance was demonstrated to the following specifications as listed in the official Journal of the European Communities:

#### **EN 50082-1:1992**

IEC 801-2:1991  
Second Edition  
IEC 1000-4-2:1995

#### **Generic Immunity**

Electrostatic Discharge  
Immunity

ENV 50140:1993  
IEC 1000-4-3:1995

Radiated Electromagnetic  
Field Immunity

#### **EN 50081-1:1992**

EN 55011:1991

#### **Generic Emissions**

Radiated and Conducted  
Emissions

#### **EN61010-1: 1993**

#### **Safety**

## SPECIFICATIONS

### COMMUNICATIONS PORT:

Format:	RS-232C
Lines supported:	Transmit, receive, common.
Connector type:	9-pin "D" female
Cable length:	3 m (9.8 ft.) maximum
Receive input resistance:	3 kohm minimum
Receive voltage limit:	$\pm 30$ V maximum
Transmit output voltage:	$\pm 5$ V min, $\pm 8$ V typical
Baud rate:	2400
Stop bits:	1
Character length:	8
Parity:	None
Standards supported:	IEEE-1987.2, SCPI-1991

### EMC APPLICATION NOTE

Use only high quality, double shielded cables for RS-232 connection. Keep the length of the cables less than 3 meters (9.8 ft.). Long cables (>3m) with insufficient EMI shielding can cause excessive emissions or may be susceptible to external interference.

# SPECIFICATIONS

## ZERO FLUX CHAMBER

<b>MODEL NUMBER:</b>	YA-111
<b>CAVITY DIMENSIONS:</b>	
Length:	50.8 mm (2")
Diameter:	8.7 mm (0.343")
<b>ATTENUATION:</b>	80 dB to 30 mT (300 G)
<b>PURPOSE:</b>	To shield the probe from external magnetic fields during the ZERO or RELATIVE operations.

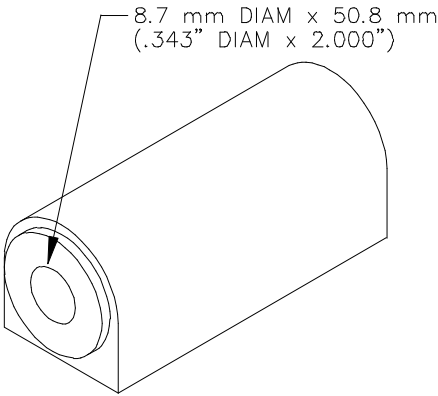

Figure 2-1  
Zero Flux Chamber



# Section 3

## Operating Instructions

### SAFETY INSTRUCTIONS:



#### GENERAL:

For safe and correct use of this meter it is necessary that both operating and servicing personnel follow generally accepted safety procedures plus the safety cautions and warnings specified.

If it is determined that safety protection has been impaired, the meter must be made inoperative and be secured against any unintended operation. For example, safety may be impaired if the meter fails to perform or shows visible damage.



#### CAUTION:

All input and output voltages, except line (mains), are less than 20V.



#### WARNING:

The opening of covers or removal of parts might expose live parts and accessible terminals which can be dangerous.



#### WARNING:

Any interruption of protective earth conductors or disconnection of the protective earth terminals inside or outside of the meter can create a dangerous condition.



#### CAUTION:

For continued protection replace the fuse with the same type (0.25 ampere, IEC 127 type T).

## OPERATING INSTRUCTIONS



### WARNING:

The Hall probe is a non-contact measuring device. The probe is not to contact a surface which exceeds a voltage of 30Vrms (42.4V peak) or 60V d.c.

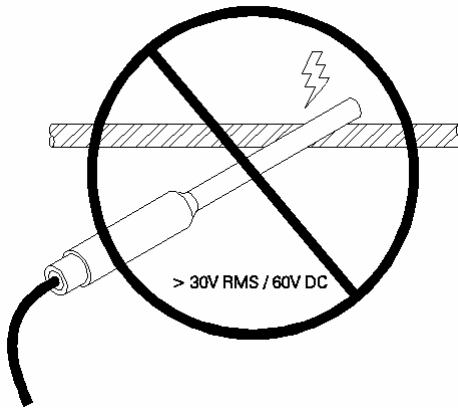

Figure 3-1  
Probe Electrical Warning



### CAUTION:

This instrument may contain ferrous components which will exhibit attraction to a magnetic field. Care should be utilized when operating the instrument near large magnetic fields, as pull-in may occur. Extension cables are available to increase the probe cable length, so that the instrument can remain in a safe position with respect to the field being measured with the probe.



### WARNING:

Replace battery only with Powersonic PS1220 or F. W. Bell Item Number 335635.

# OPERATING INSTRUCTIONS

## GENERAL DESCRIPTION:

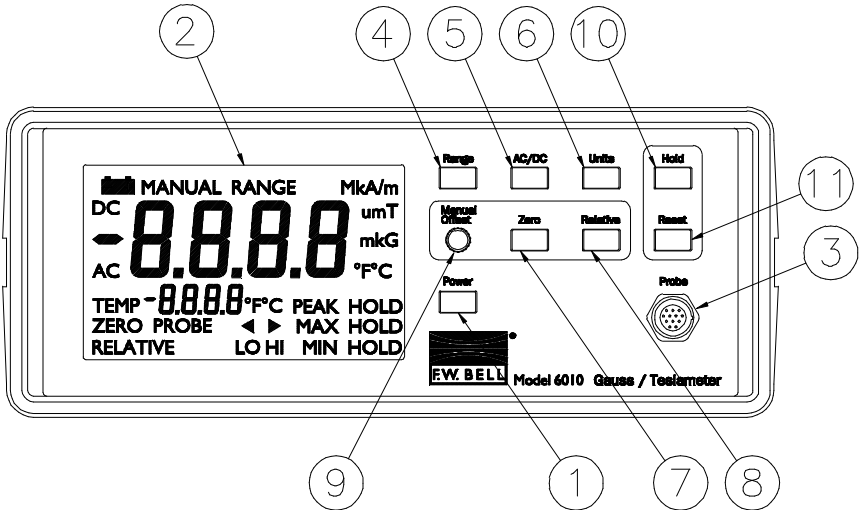

Figure 3-2  
Front Panel

- ① **Power Switch:** Push-on / push-off type switch to apply power to the instrument.
- ② **Display:** Liquid crystal display (LCD)
- ③ **Probe Connector:** The Hall probe or adapter cable plugs into this connector and locks in place. To disconnect, pull on the body of the plug, *not the cable!*
- ④ **Range:** Selects between automatic ranging and each of the Manual ranges.
- ⑤ **AC /DC:** Selects between Periodic (AC) and Static (DC) magnetic fields.
- ⑥ **Units:** Selects between Gauss (G), Tesla (T), Ampere per meter (A/m). If a temperature compensated probe is attached, it also allows the selection between degrees Fahrenheit ( $^{\circ}\text{F}$ ) and degrees Celsius ( $^{\circ}\text{C}$ ).

## OPERATING INSTRUCTIONS

- 7 **Zero:** Used to null low level magnetic field and electrical offsets.
- 8 **Relative:** Used to offset an existing magnetic field. Once the relative mode is activated, all measurements are made relative to this field.
- 9 **Manual Offset:** Allows for a manual fine adjustment of zero point.
- 10 **Hold:** Selects between “Peak Hold”, “Max Hold: and “Min Hold” and Fast “Peak Hold”
- 11 **Reset:** Clears the held reading during HOLD operation.

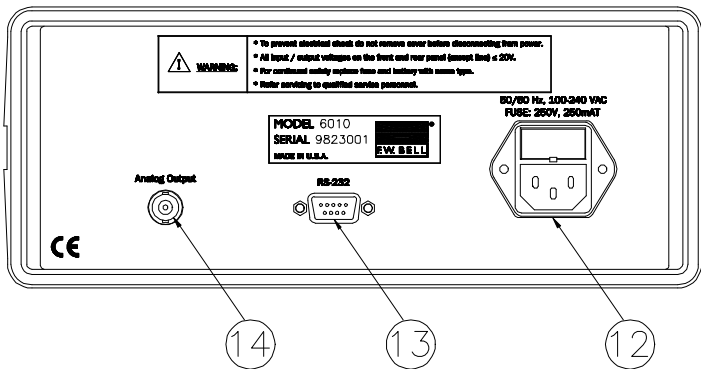

Figure 3-3  
Rear Panel

- 12 **Power Entry:** Accepts 100 Vac to 240 Vac and contains line fuse.
- 13 **RS-232 Port:** Shielded 9-pin “D” connector supporting RS-232-C serial communication.
- 14 **Analog Output Connector.** A voltage signal representative of the magnetic flux density being measured is available at this BNC connector. Calibration is set to  $\pm 3.0$  V full scale dc or 3.0 Vrms ac, depending upon the mode of operation . Minimum load is 10 kohm.



## OPERATING INSTRUCTIONS

### INSTRUMENT PREPARATION:

Install the probe or probe extension cable by matching the key way in the connector to that in the mating socket in the meter. The connector will lock in place. To disconnect, pull on the body of the plug, ***not the cable!***

### POWER-UP

Depress the POWER switch. There will be a momentary audible beeps and each display function will appear sequentially on the display.

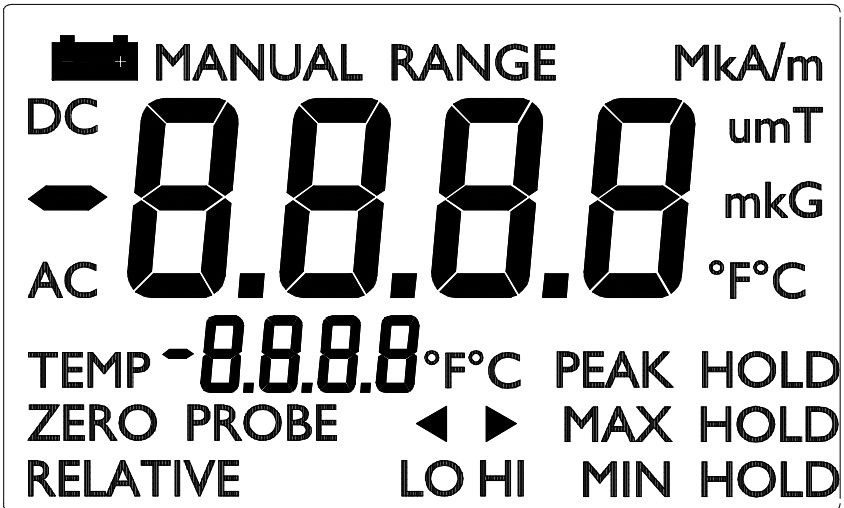

Figure 3-4  
Power-Up Display

## OPERATING INSTRUCTIONS

The instrument will conduct a self-test before measurements begin. If a problem is detected the phrase “Err” will appear on the display along with a 3-digit code. The circuitry that failed will be retested and the error code will appear after each failure. This process will continue indefinitely or until the circuitry passes the test. A condition in which a circuit fails and then passes should not be ignored because it indicates an intermittent problem that should be corrected.

If the self test is successful the meter will perform a self calibration, indicated by the phrase “CAL” on the display. During this phase the meter will display the software revision number, such as “r 1.1”. Calibration will halt if there is no Hall probe connected. Until the probe is connected the phrase “Err” will appear accompanied by a flashing “PROBE” annunciator as shown in Figure 3-5.



Figure 3-5  
Missing Probe Indication

## OPERATING INSTRUCTIONS

### POWER-UP SETTINGS:

The meter permanently saves certain aspects of the instrument's setup and restores them the next time the meter is turned on.

The conditions that are saved are:

- RANGE setting (including AUTO range)
- MODE (ac or dc)
- UNITS of measure (gauss, tesla or ampere/meter, °F or °C).
- HOLD mode (Min, Max or Peak or fast Peak)

Other aspects are not saved and default to these conditions:

- RELATIVE mode (turned OFF)
- RELATIVE value (set to 0)
- ZERO mode (inactive)

### LOW BATTERY CONDITION:

The instrument is equipped with internal rechargeable battery. When the battery is fully charged it can supply power to the unit for a period of 8 hours. When the battery voltage becomes too low the battery symbol on the display will flash, as shown in figure 3-6. As long as the instrument is connected to line power the internal battery is being charged, whether or not the unit is turned on.



***Instrument specifications are not guaranteed when a low battery condition exists !***

## OPERATING INSTRUCTIONS



Figure 3-6  
Low Battery Indication

### OVERRANGE CONDITION:

If the magnitude of the magnetic flux density exceeds the limit of the selected range the meter will display a flashing value of “2999” (gauss or tesla mode) or “2387” (ampere/meter mode). The next highest range should be selected. If already on the highest range then the flux density is too great to be measured with this instrument.

When a temperature compensated probe is used and temperature is being measured an overrange condition occurs below  $-40^{\circ}\text{C}$   
( $-40^{\circ}\text{F}$ ) and above  $+100^{\circ}\text{C}$  ( $+212^{\circ}\text{F}$ )

## OPERATING INSTRUCTIONS



Figure 3-7  
Overrange Indication

### **AC OR DC MEASUREMENT SELECTION:**

The meter is capable of measuring either static (dc) or alternating (ac) magnetic fields. To choose the desired mode, press the AC/DC pushbutton to select AC or DC on the display.

The dc and ac modes are discussed in more detail later in this section.

This setting is saved and will be restored the next time the meter is turned on.

## **OPERATING INSTRUCTIONS**

### **UNITS OF MEASUREMENT SELECTION:**

The instrument is capable of providing flux density measurements in terms of gauss (G), tesla (T) or ampere per meter (A/m). If a temperature compensated probe is connected to the instrument, it can also measure temperature in degrees Fahrenheit (°F) or in degrees Celsius (°C).

#### **To choose the desired units**

- 1) Standard probe (without temperature compensation) is connected to the meter:

Press the UNIT pushbutton to select between one of the three available units of gauss (G), tesla (T) or ampere per meter (A/m).

- 2) Temperature compensated probe is connected to the meter:

Press the UNIT pushbutton. The symbol G will appear in the right corner of the display. If no further key is pressed, the instrument will display the flux density in gauss (G) without monitoring the probe temperature.

If the UNIT key is pressed again, the legend TEMP and °C will be displayed next to lower readout. This denotes that while the flux density is measured and monitored on the upper readout in gauss (G), the probe temperature will be displayed on the lower readout in °C. Pressing the UNIT key one more time changes °C to °F.

## OPERATING INSTRUCTIONS

This process can be repeated for selecting tesla (T) or ampere per meter (A/m). For each unit of flux density, the user may choose:

- Not to display the probe temperature in the lower readout
- Display the probe temperature in lower readout in °C
- Display the probe temperature in lower readout in °F

By continuing to press the UNIT key, the user can choose to display the probe temperature on the *main* (upper) readout in °F or °C. In this mode flux density measurements are not available.

This setting is saved and will be restored the next time the meter is turned on.

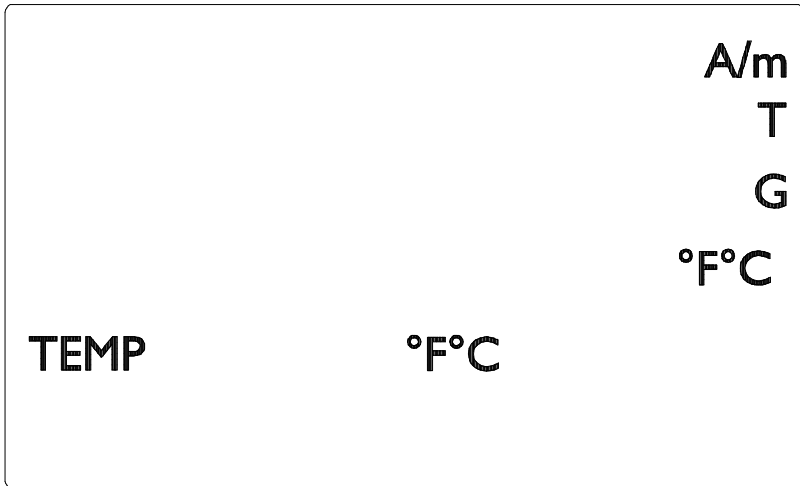

Figure 3-8  
The legends associated with the UNIT function

## OPERATING INSTRUCTIONS

### RANGE SELECTION:

The meter is capable of providing flux density measurements on one of three fixed ranges, or it can be programmed to automatically select the best range for the present flux density. In MANUAL range mode, the available ranges are listed in the *SPECIFICATIONS* section of this manual. The ranges advance in decade steps. The lowest range offers the best resolution while the highest range allows higher flux levels to be measured.

In the AUTO range mode the range is advanced if the reading reaches the full scale of the present range. This is 2999 if in the gauss or tesla mode (such as 299.9 G or 299.9 mT), or 2387 if in the ampere/meter mode (such as 23.87 kA/m). The range is lowered if the present reading falls below 10% of full scale for the present range. The speed at which the readings are updated decreases slightly when AUTO ranging is used.

**NOTE:** When the MANUAL RANGE indicator does not appear the instrument is in AUTOMATIC ranging mode. Also the AUTO range selection will be canceled if the RELATIVE mode or HOLD mode is turned on.

Press the RANGE pushbutton for the desired range.

This setting is saved and will be restored the next time the meter is turned on.

**NOTE:** The RANGE pushbutton has no effect when measuring temperature on the main (upper) readout.



## OPERATING INSTRUCTIONS

### HOLD MODE SELECTION:

In some applications it may be desirable to hold a reading that is either greater than or less than all previous readings, or which has the greatest peak value whether positive or negative.

The MAX HOLD function holds the reading that is arithmetically greater than all previous readings. For instance, a reading of +125.0 is greater than +99.0 or -150.0.

The MIN HOLD function holds the reading that is arithmetically less than all previous readings. For instance, a reading of -125.0 is less than -99.0 or +150.0.

The PEAK HOLD function captures and holds the peak value of the flux density waveform within the response time capabilities of the meter. See the *SPECIFICATIONS* section of this manual for more information. The peak can be either positive or negative, whichever has the greatest magnitude. For instance a peak value of -100.0 is greater than a peak value of +90.0. PEAK HOLD can operate in two different speeds, normal and FAST. The response for each mode is given in the SPECIFICATIONS. The FAST PEAK HOLD mode is used to track rapid events such as magnetizing pulses.

When PEAK HOLD, MAX HOLD or MIN HOLD is activated the main (upper) readout displays the held value and the lower readout displays the actual or tracking value. The only exception is when FAST PEAK HOLD mode is selected. In this case the tracking value is not displayed. The word FAST will appear on the lower readout.

Press the HOLD pushbutton to select any of the desired modes, MAX HOLD, MIN HOLD, PEAK HOLD, FAST PEAK HOLD or off.

## OPERATING INSTRUCTIONS

**Note:** The HOLD functions can only be used on a MANUAL RANGE. If automatic ranging is used and a HOLD function is turned on, the automatic ranging is cancelled and a manual range is selected.

**Note:** If the instrument has been configured to measure flux density on the main (upper) readout and temperature on the lower readout the HOLD functions will override the temperature readout. If the meter has been configured to display temperature on the upper readout, the HOLD functions can be used to hold the PEAK, MAX or MIN of the measured temperature. FAST PEAK HOLD is not available.

This setting is saved and will be restored the next time the meter is turned on.

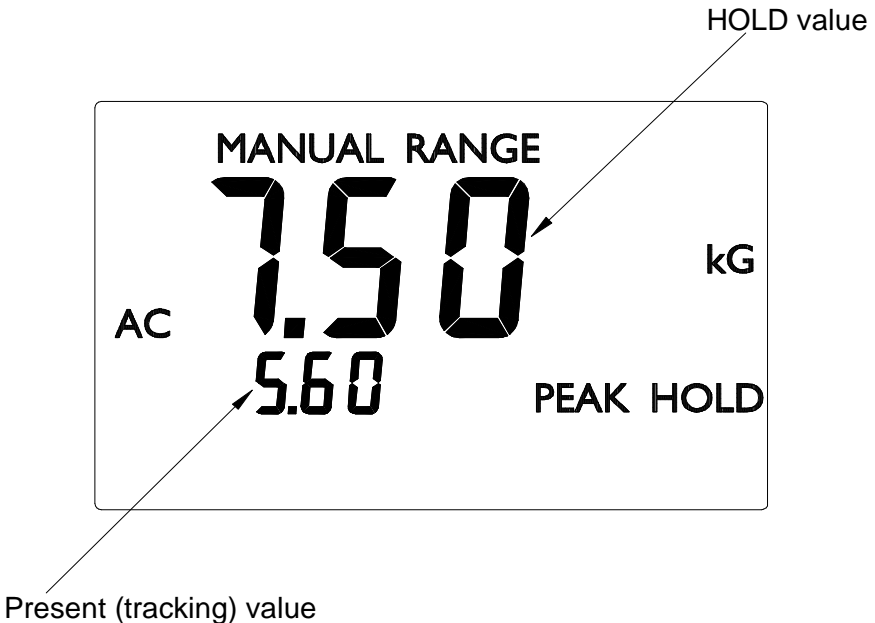
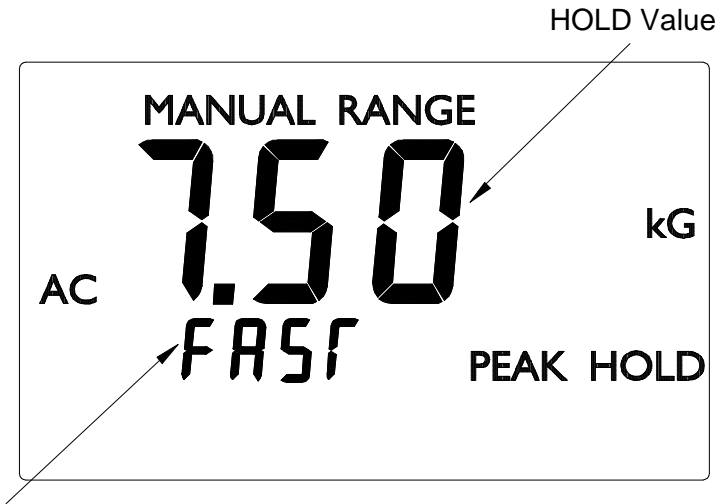

Figure 3-9  
HOLD Function

## OPERATING INSTRUCTIONS



Indicates FAST PEAK HOLD mode

Figure 3-10  
FAST PEAK HOLD

### MIN, MAX, PEAK HOLD USAGE:

See the *SPECIFICATIONS* section for response time information.

The MAX HOLD function holds the reading that is *arithmetically* greater than all previous readings. The MIN HOLD function holds the reading that is *arithmetically* less than all previous readings. The PEAK HOLD function holds the largest magnitude regardless of polarity. In all three modes the present flux density reading appears on the lower readout while the held reading appears on the upper readout.

These modes are useful in determining the maximum or minimum value of magnetic events that occur over a period of time.

## OPERATING INSTRUCTIONS

If the reading exceeds the range limit the meter will hold a flashing value of “2999” (gauss or tesla mode), “2387” (ampere/meter mode) or the maximum value allowed in the RELATIVE mode.

The held value can be reset by pressing the RESET pushbutton. The next value displayed after a reset will be the present value of flux density. For instance if the held reading is 200.0 G and the present flux density is -100.0 G, the meter will display -100.0 G after the reset.

If the analog output is being used the output signal will continue to represent the real time flux density as seen by the probe. It is not affected by the HOLD function.

### **FAST PEAK HOLD USAGE:**

See the *SPECIFICATIONS* section for response time and accuracy information.

In the FAST PEAK HOLD mode the input signal is sampled many times each second. Each sample is compared to all previous samples and that which has the greatest amplitude (regardless of polarity) is held on the display. This mode can be used to capture the peak value of a fast, one-time magnetic event such as a magnetizing pulse. In this mode the present flux density is not displayed. The lower readout will display the word “FAST”.

In FAST PEAK HOLD operation if the reading exceeds the range limit the meter will hold a flashing value of “2999” (gauss or tesla mode), “2387” (ampere/meter mode) or the maximum value allowed in the RELATIVE mode. Pressing the RESET pushbutton resets the held value.

## OPERATING INSTRUCTIONS

The main differences between the FAST PEAK HOLD mode and the MIN / MAX HOLD modes are:

- The PEAK HOLD mode considers only the magnitude of the reading and not the polarity.
- The response time of the FAST PEAK HOLD mode is much faster but final accuracy is less.

The analog output will continue to represent the real time flux density as seen by the probe.

### ZERO FUNCTION:

“Zeroing” the probe and meter is one of the most important steps to obtaining accurate dc flux density measurements. The ideal Hall generator produces zero output in the absence of a magnetic field, but actual devices are subject to variations in materials, construction and temperature. Therefore most Hall generators produce some output even in a zero field. This will be interpreted by the meter as a flux density signal.

Also, the circuits within the meter can produce a signal even when there is no signal present at the input. This will be interpreted as a flux density signal. Lastly magnetic sources close to the actual field being measured, such as those from electric motors, permanent magnets and the earth (roughly 0.5 gauss or 50  $\mu$ T), can introduce errors in the final reading.

It is vital to remove these sources of error prior to making actual measurements. The process of “zeroing” removes all of these errors in one operation. The meter cancels the combined dc error signal by introducing another signal of equal magnitude with opposite polarity. After zeroing, the only dc signal that remains is

## OPERATING INSTRUCTIONS

one that is produced by the probe when exposed to magnetic flux.

**NOTE:** Zeroing the meter and probe affects only the static (dc) component of the flux density signal.

**NOTE:** The process of zeroing also affects the analog signal.

There may be situations when the user prefers to shield the probe from all external magnetic fields prior to zeroing. Provided with the meter is a ZERO FLUX CHAMBER which is capable of shielding against fields as high as 30 mT (300 G or 23.88 kA/m). The probe is simply inserted into the chamber before the zeroing process begins.



***Handle the Hall probe with care. Do not bend the stem or apply pressure to the probe tip as damage may result.***

In other situations the user may want the probe to be exposed to a specific magnetic field during the zeroing process so that all future readings do not include that reading (such as the earth's field). This is possible with the following restrictions:

- 1) The external field must not exceed 30 mT (300 G or 23.88 kA/m).
- 2) The field must be stable during the zeroing process. It should not contain alternating (ac) components.

If either of these conditions is not met the zeroing process will stop and the meter will report an error code of E050 (see Figure 3-11).

## OPERATING INSTRUCTIONS

### **AUTOMATIC ZERO FUNCTION:**

The meter provides two methods to zero the probe. The first is completely automatic. Prepare the probe for zeroing then press the ZERO pushbutton. The “ZERO” legend will flash and actual dc flux density readings will appear on the display. The meter will select the lowest range regardless of which range was in use prior to using the ZERO function. Recall that the maximum flux density level that can be zeroed is 30 mT (300 G or 23.88 kA/m). If the existing field is too large consider using the RELATIVE mode (discussed later in this section). Recall that the zeroing operation affects dc offsets only. If you wish to suppress an ac field consider using the RELATIVE mode.

Press the ZERO pushbutton and the process will begin and the “ZERO” legend will flash. Once automatic zeroing begins it must be allowed to complete. During this time all controls are disabled except for the POWER switch. The process normally takes from 5 to 15 seconds.

The instrument selects the lowest range and adjusts the nulling signal until the net result reaches zero. No further electronic adjustments are made, but at this stage a reading is acquired which will be mathematically subtracted from all future readings on this range.

If the nulling process is successful, the next higher range is selected and the zeroing process is repeated for that range. The zeroing process continues for all remaining ranges. During the zeroing process the “ZERO” legend flashes. When finished, the instrument will sound an audible beep and will resume normal flux density measurements. The zero function has no effect on temperature measurement.

## OPERATING INSTRUCTIONS

The final zero values will remain in effect until the instrument and probe are zeroed again, if the probe is disconnected or if the meter is turned off and back on again.

**NOTE:** If the existing field is too large or unstable the meter will sound a double beep and the phrase “ERR” will appear momentarily on the display along with the error code E050 as shown in figure 3-11. At this point the automatic process is terminated.

**NOTE:** Zeroing the probe cancels the RELATIVE mode if it was turned on.



Figure 3-11  
Probe zeroing Error code



## OPERATING INSTRUCTIONS

### MANUAL OFFSET FUNCTION:

This feature also allows the user to manually set the “zero” point to a value other than zero or to make a fine adjustment to the zero point after an automatic zeroing. Position the probe for zeroing, then rotate the MANUAL OFFSET knob to the desired setting. This value will be added to (or subtracted from) all future readings. Recall that the maximum flux density level that can be zeroed is 30 mT (300 G or 23.88 kA/m). If the existing field is too large, consider using the RELATIVE mode (discussed later in this section). MANUAL OFFSET operation affects DC offsets only, therefore it can only be used when DC mode is selected. If you wish to suppress an ac field consider using the RELATIVE mode.

By turning the MANUAL OFFSET control in either direction the reading will be altered. Turning the control clockwise adds to the reading, turning it counterclockwise subtracts from the reading.

**NOTE:** Making a manual ZERO adjustment not only affects the lowest range but also the higher ranges, though to a lesser extent. For example, assume an automatic ZERO has already been performed, after which all ranges should read zero. Now a manual adjustment is made that causes the reading on the lowest range to be non-zero. The reading on the other ranges may also be non-zero depending upon the magnitude of the change.

### RELATIVE MODE:

The RELATIVE mode allows a specific flux density value to be subtracted from all future readings. Thus all future readings will be “relative” to that value. For instance if the relative value is +100.0 gauss, and the present flux density is +112.0 gauss, the actual displayed value will be +12.0 gauss. If the flux density

## OPERATING INSTRUCTIONS

drops to +77.0 gauss, the actual displayed value will be -23.0. Thus the RELATIVE mode allows for the direct readout of variations around a given field, whether static (dc) or alternating (ac).

There are two ways to generate a relative value. In the automatic mode the meter uses the present flux density reading from the probe as the relative value. In the manual mode, the user can specify a value using the MANUAL OFFSET control. Each mode will be discussed in more detail.

There are three restrictions when using the RELATIVE mode:

- 1) The RELATIVE mode can only be used on a fixed range. If the automatic ranging feature is in and then the RELATIVE mode is turned on the automatic ranging feature is canceled. Conversely, if the RELATIVE mode is turned on and then the automatic ranging feature is turned on, the RELATIVE mode is canceled.
- 2) If the RELATIVE mode has been turned ON and the probe is zeroed via the ZERO function, the RELATIVE mode is canceled.
- 3) The point at which the meter declares an OVERRANGE condition changes when using the RELATIVE mode. Normally an overrange occurs when the reading reaches the full scale limit of  $\pm 2999$  in the gauss or tesla mode (such as  $\pm 299.9$  G,  $\pm 29.99$  mT, etc.) or  $\pm 2387$  if in the ampere/meter mode (such as 23.87 kA/m). At that point the digits will remain at "2999" or "2387" and will flash to indicate an overrange condition. If temperature is being displayed, an overrange occurs for values below  $-40^{\circ}\text{C}$  ( $-40^{\circ}\text{F}$ ) or above  $+100^{\circ}\text{C}$  ( $+212^{\circ}\text{F}$ )

In the RELATIVE mode the flux density can be exceeded by about 35% to a maximum value of  $\pm 4095$  as seen by the probe.

## OPERATING INSTRUCTIONS

To clarify this, suppose the meter is set to the 300 mT range and the probe is in a +350 mT field. Under normal conditions this would have resulted in an overrange condition (a flashing reading of +299.9 mT). Now the RELATIVE mode is turned on with an initial relative value of 0. In this mode the meter is able to measure flux density up to  $\pm 409.5$  mT. A non-flashing reading of +350.0 mT will now appear on the display.

There may be situations when the user may prefer to shield the probe from all external magnetic fields prior to performing a RELATIVE operation. Provided with the meter is a ZERO FLUX CHAMBER which is capable of shielding against fields as high as 30 mT (300 G or 23.88 kA/m). The probe is simply inserted into the chamber before the RELATIVE operation begins.

**NOTE:** The RELATIVE mode is canceled if the probe and instrument are zeroed, if the probe is disconnected, if the instrument's range is changed or if the instrument is turned off and back on again.

**NOTE:** If the analog output is being used, the output signal will continue to represent the flux density as seen by the probe. It is not affected by the RELATIVE operation.

### **AUTOMATIC RELATIVE MODE:**

In the automatic mode, the present flux density as seen by the probe is used as the relative value. Prepare the probe and select an appropriate range and mode (ac or dc) as needed (automatic ranging is deactivated when RELATIVE mode is used).

Press the RELATIVE pushbutton to perform all automatic relative operation. The "RELATIVE" legend will flash for a moment and a

## **OPERATING INSTRUCTIONS**

reading will be acquired. This now becomes the new relative value. The instrument will sound a single beep and the "RELATIVE" legend will remain on to remind the user that the RELATIVE mode is active and that the displayed value is a relative value, not an absolute value. The reading should now be zero. From this point the relative value will be subtracted from all future readings

### **MANUAL RELATIVE MODE:**

The second method by which to set a relative value is a manual adjustment. In some cases the user will wish to set an absolute relative value. To do this, insert the probe in the ZERO FLUX CHAMBER provided with the meter. Perform an automatic relative operation (see previous discussion). Upon completion turning the MANUAL OFFSET control in either direction will alter the reading. Turning the control clockwise adds to the reading, turning it counterclockwise subtracts from the reading.

Once the desired relative value has been reached, the probe can be removed from the ZERO FLUX CHAMBER and measurements can begin. The final relative value will be subtracted from all future readings.

### **ANALOG OUTPUT:**

The meter is capable of providing an analog voltage signal proportional to the present flux density level. Calibration is set to  $\pm 3.0$  V full scale dc or 3.0 Vrms ac, depending upon the mode of operation. When measuring temperature and the temperature is displayed in the upper readout, the analog output signal is calibrated to 10 mV / °C or 10 mV / °F. This signal, available at

## **OPERATING INSTRUCTIONS**

the rear BNC connector, can be connected to a voltmeter, oscilloscope, recorder or external analog-to-digital converter.

## OPERATING INSTRUCTIONS

### ANALOG OUTPUT USAGE:

See the *SPECIFICATIONS* section for frequency range and accuracy of the analog output.

For flux density measurements the analog output signal is calibrated to  $\pm 3$  Vdc or 3 Vrms, depending upon the selected mode. For instance on the 30 mT range a reading of -12.3 mT relates to a output voltage of -1.23 Vdc whereas on the 3 T range a reading of -1.23 T produces the same output. The analog output can reach a maximum output of about  $\pm 4.25$  Vdc in order to accommodate the peak value of a 3 Vrms ac signal. This means that the analog output can be used to measure flux density levels that exceed the normal range of the displayed readings. For instance a level of 36.5 mT on the 30 mT range would normally result in a flashing "29.99" mT overrange condition, but the output will still be +3.65 Vdc.

When using AUTO range and the analog output features together, the following situation can occur. Suppose the present range is 3 kG and the present reading is +2.8 kG. The analog output will be +2.8 Vdc. The signal then increases to +3.2 kG, which would force an automatic change to the 30 kG range setting. The analog output will now be +0.32 Vdc because of the range change. This can lead to problems if the analog signal is being used to make decisions, because there is no indication that a range change has occurred. In these situations it is best to select a fixed range that covers the expected flux density span.

The analog output signal contains both the dc and ac components of the flux density signal. This means that it will also contain any initial dc offsets in the probe and the meter's circuitry. These offsets can be removed by the ZERO function.

## OPERATING INSTRUCTIONS

The MANUAL OFFSET control can also be used to introduce a dc offset if desired. This is useful when observing ac waveforms in which one portion of the waveform is being clipped because it exceeds the  $\pm 4.25$  Vdc limit of the meter. Using the MANUAL OFFSET control the center of the waveform can be moved to reduce or eliminate the clipping, as depicted in the next figure.

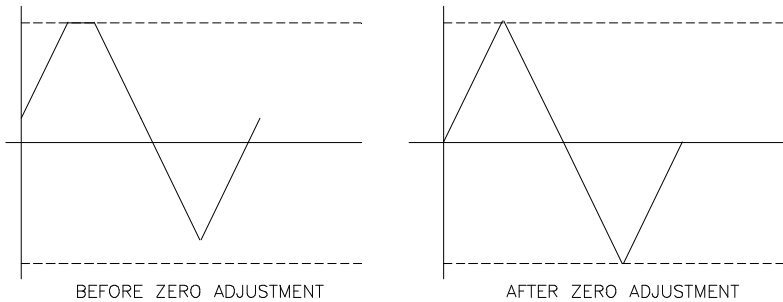

Figure 3-12  
Adjusting the DC Offset of the Analog Output

When measuring temperature on the upper readout, the analog output is calibrated to 10 mV/ $^{\circ}$ C or 10 mV/ $^{\circ}$ F. Thus for the entire temperature range the analog output will produce  $-400$  mV to  $+1000$  mV for  $^{\circ}$ C and  $-400$  mV to  $+2120$  mV for  $^{\circ}$ F.

### SOURCES OF MEASUREMENT ERRORS:

When making flux density measurements there are several conditions that can introduce errors:

- 1) Operating the meter while the LOW BATTERY symbol appears.

## OPERATING INSTRUCTIONS



***Instrument specifications are not guaranteed when a low battery condition exists !***

- 2) Failure to ZERO the error signals from the meter, probe and nearby sources of magnetic interference.
- 3) Subjecting the probe to physical abuse.
- 4) One of the most common sources of error is the angular position of the probe with respect to the field being measured. As mentioned in Section-1, a Hall generator is not only sensitive to the number of flux lines passing through it but also the *angle* at which they pass through it. The Hall generator produces the greatest signal when the flux lines are perpendicular to the sensor as shown in Figure 3-13.

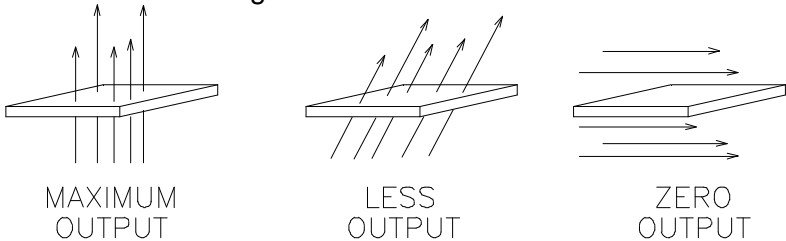

Figure 3-13  
Probe Output versus Flux Angle



***The probe is calibrated and specified with flux lines passing perpendicularly through the Hall generator.***

- 5) As shown in Figure 3-14 as the distance between the magnetic source and the Hall probe increases fewer flux lines will pass through the probe, causing the probe's output to decrease.



## OPERATING INSTRUCTIONS

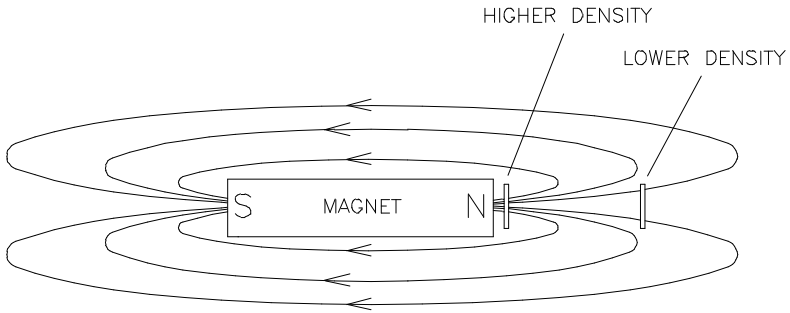

Figure 3-14  
Probe Output versus Distance

6) Flux density can vary considerably across the pole face of a permanent magnet. This can be caused by internal physical flaws such as hairline cracks or bubbles, or an inconsistent mix of materials. Generally the sensitive area of a Hall generator is much smaller than the surface area of the magnet, so the flux density variations are very apparent. Figure 3-15 illustrates this situation.

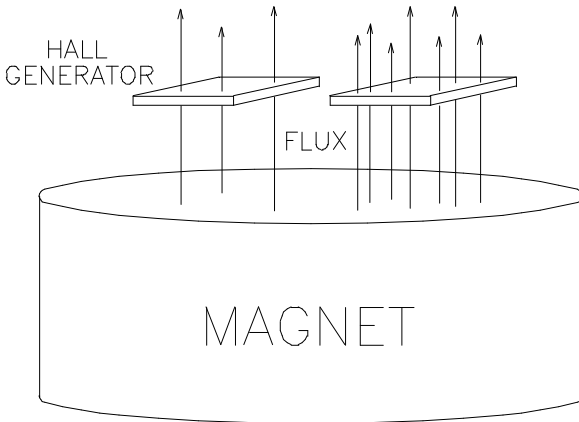

Figure 3-15  
Flux Density Variations in a Magnet

## OPERATING INSTRUCTIONS

8) The accuracy of the instrument and probe are affected by temperature variations. Refer to the *SPECIFICATIONS* section for specific information. Temperature variations are greatest during the initial warm up phase after power-up (15 minutes). Allow the instrument and probe to stabilize for best accuracy.

### MORE DETAILS ON AC MODE OPERATION:

It is possible for the flux density signal to contain both a dc component and an ac component. In the ac mode the value displayed is the true rms value of the waveform with its dc component removed. However if the dc component is too high it may force the peak value of the waveform to exceed the electrical limits of the meter, causing the waveform to clip and introducing errors in the final reading. This can also lead to an overrange condition on the display and can lead to erratic behavior if the automatic ranging feature is being used. The presence of a clipped ac signal can be verified by observing the analog output signal.

The accuracy of the true rms reading is only guaranteed for readings greater than about 3.3% of the full scale range. For example this would be 1mT on the 300 mT range. When the reading falls below 3.3% of full scale the "LO" legend on the display will flash, as shown in Figure 3-16. This is intended to remind the user that the reading may not be accurate. Select a lower range if possible to regain accuracy.

## OPERATING INSTRUCTIONS

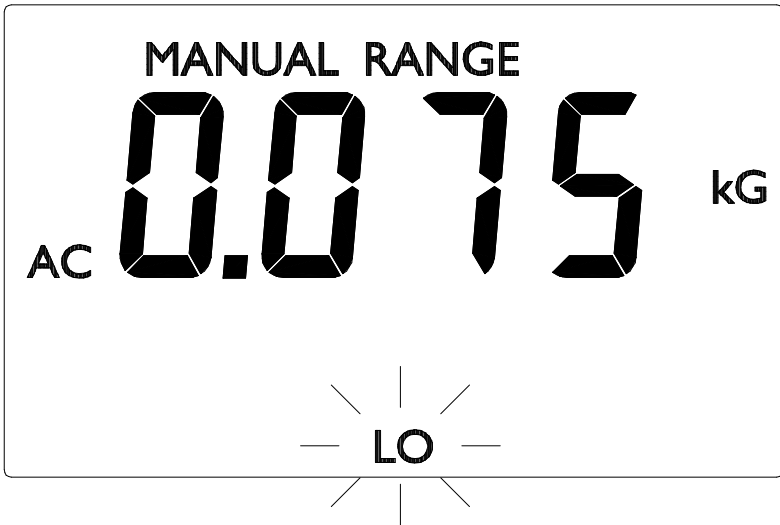

Figure 3-16  
Low AC Signal Indication

An ac reading, being a true rms value, has no polarity. However when using the RELATIVE function in the ac mode readings can be negative. A negative ac reading means that the present reading is *less than* the RELATIVE value. An unsigned value means the present reading is greater than or equal to the RELATIVE value. For example if the original RELATIVE value was 100 mT and the present field is 80 mT the result will be -20 mT rms.

When using the MIN HOLD function without the RELATIVE function turned on the minimum reading will be 0.0. With the RELATIVE function turned on the minimum reading can reach the negative full scale limit of the instrument.

## **OPERATING INSTRUCTIONS**

### **MORE DETAILS ON DC MODE OPERATION:**

It is possible for the flux density signal to contain both a dc component and an ac component. In the dc mode this can lead to unstable readings. If the peak value of the ac component reaches the electrical limits of the meter, even though the average dc level is within the limits, an overrange condition may appear on the display. This situation can also lead to erratic behavior if the automatic ranging feature is being used.

The presence of an ac signal can be verified by observing the analog output signal or by using the ac mode to determine the magnitude of the ac component.

### **TEMPERATURE EFFECTS:**

The probe's dc offset and sensitivity are affected by temperature. Using temperature-compensated probes will minimize these effects.

There can be substantial errors in uncompensated probes. A typical probe's dc offset can change by  $\pm 0.1 \text{ G} / ^\circ\text{C}$ . It is best to allow the probe's temperature to stabilize before performing a ZERO operation. The probe's sensitivity will drop as temperature increases. Probes are calibrated at ambient temperature ( $23^\circ\text{C}$ ). A typical probe may change by  $-0.05\% / ^\circ\text{C}$ . For instance a reading of 200 mT at  $23^\circ\text{C}$  may drop to 197 mT at  $50^\circ\text{C}$ .

# Section 4

## Remote Operation

### RS-232 INTERFACE PARAMETERS:

Prior to using the RS-232 serial port several parameters such as baud rate and character length must be set on the computer or PLC to match that of the meter. The meter's parameters cannot be changed. These are:

BAUD RATE:	2400
CHARACTER LENGTH:	8
PARITY:	NONE
STOP BITS:	1

### RS-232 INTERFACE CONNECTION:

#### EMC APPLICATION NOTE:

Use only high quality, double shielded cables for RS-232 connection. Keep the length of the cables less than 3 meters. Long cables (>3m) with insufficient EMI shielding can cause excessive emissions or may be susceptible to external interference.

The interface connector is a standard 9-pin "D" type connector commonly used on personal computers. Five signals are supported as shown in Figure 4-1. One of these is the common (ground) connection. Pins-1,4,6 and 9 are not connected.

## REMOTE OPERATION

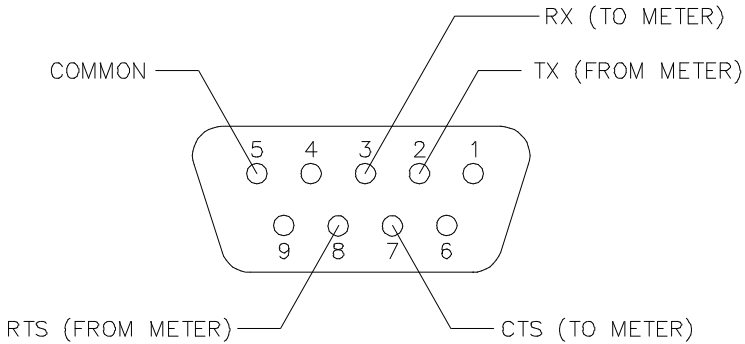

Figure 4-1  
9-Pin Interface Connector

Data is transmitted to the meter on the receive (RX) line. Data is transmitted from the meter on the transmit (TX) line. This is known as a “full duplex” link.

In some RS-232 applications two lines called Clear-To-Send (CTS) and Request-To-Send (RTS) are used to control the flow of data between devices. This is often referred to as “hardware handshaking”. However, although these signals are connected electrically within the meter, the signals are not presently used. The user’s computer or PLC should be configured to ignore hardware handshaking lines.

In most cases a straight-through cable can be used between the meter and a personal computer. In other words Pin-1 on the meter would attach to Pin-1 on the computer, Pin-2 to Pin-2, etc. Figure 4-2 depicts two possible connection schemes.

## REMOTE OPERATION

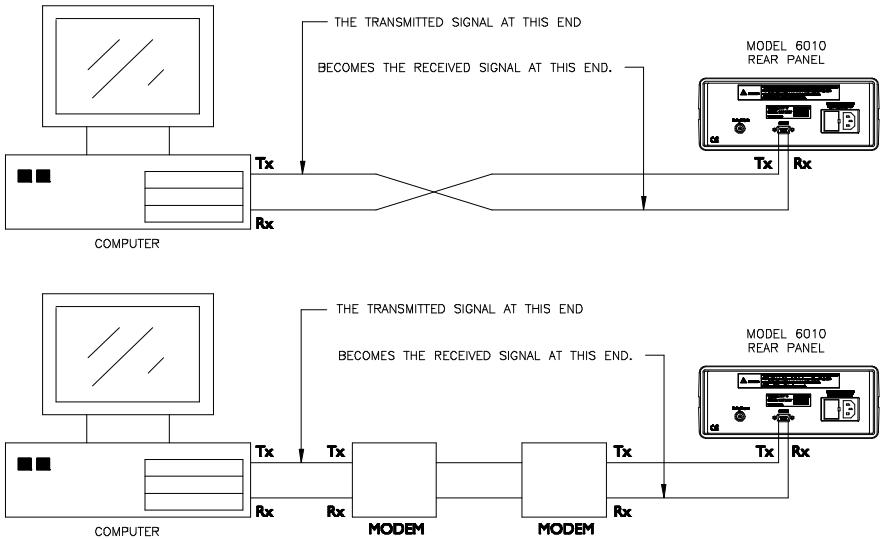

Figure 4-2  
Serial Port Connection Schemes

Generally most communications problems are caused by incorrect wiring or failure to match the characteristics (baud rate, parity, etc.). Consult the documentation for the computer or PLC to determine the signal assignments for its communication connector. Again, the hardware handshake lines RTS and CTS are not supported and should be ignored.

### REMOTE COMMAND STANDARDS:

Prior to 1987 most instruments that featured RS-232 communications interfaces had their own unique commands for exchanging information. Eventually some manufacturers began

## REMOTE OPERATION

offering models that recognized other manufacturer's commands so that customers could easily switch over without making extensive changes to their programs.

The IEEE-488-1987.2 standard (also called "IEEE-488.2") was one step toward creating a universal way to communicate with any instrument, regardless of the manufacturer or the type of instrument used. This was later enhanced by the SCPI-1991 standard (Software Commands for Programmable Instruments), which defined specific commands and responses that covered a broad range of applications. Though these standards were targeted for use with the IEEE-488 instrumentation bus they are commonly used with serial (RS-232) interfaces as well.

The instrument supports many of the IEEE-488-1987.2 "common" commands as well as a subset of the SCPI-1991 commands.

### COMMAND FORMAT:

All commands consist of ASCII character strings. Some commands contain numeric parameters that are used to set or reset individual bits within binary registers. For instance a value of 45 decimal is the same as binary 101101, thus setting bits 5, 3, 2 and 0 in the register and resetting all others. Sending the value "00101101" would be interpreted as the number 101,101.

NOTE: No more than 250 characters can be sent in one command string.

### MESSAGE TERMINATORS:

When transmitting a string to the instrument the message must be "terminated" properly to notify the instrument that the message is complete. This is done by appending an ASCII line feed (LF)



## REMOTE OPERATION

character as the final character in the string, which is a 0A hex or 00001010 binary. Note that 0A hex is equivalent to 10 decimal, but sending the two ASCII characters "10" will not work. It must be the single byte representation of the LF control character.

The meter will always send the LF character every time it transmits a message to the host system.

### **ERROR BUFFER:**

Errors are generated by a variety of sources, such as hardware errors or errors in the command syntax. If an error occurs a message is stored in an ERROR BUFFER. The message can be retrieved by a specific command discussed later in this section.

### **STATUS REGISTERS:**

There are four register sets that indicate the status of the instrument, such as errors or the present state of the meter. These are 8-bit registers, but in many cases not all of the bits are used. The four register sets are called

MEASUREMENT EVENT  
OPERATION EVENT  
STANDARD EVENT  
QUESTIONABLE EVENT

There is also an 8-bit register that provides a 1-bit summary for each of the four register sets. This is called the STATUS BYTE.

Each register set consists of three individual registers, as depicted in Figure 4-3.

1) The CONDITION register is a real time, read-only register that is constantly updated to reflect current operating conditions.

# REMOTE OPERATION

2) The EVENT register is fed by the CONDITION register, but operates as a latch. Whenever any bit in the CONDITION register goes to “1”, a corresponding “1” is latched into the EVENT register and remains that way until cleared by a specific command.

3) The ENABLE register is a mask register that is used to generate the single status bit for the STATUS BYTE. Setting any bit in the ENABLE register to “1” will allow a corresponding “1” in the EVENT register to set the summary bit in the STATUS BYTE.

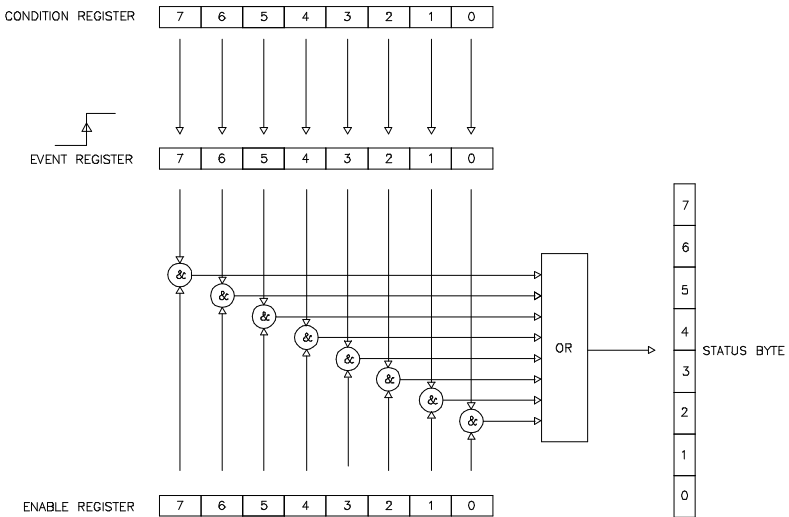

Figure 4-3  
Condition, Event and Enable registers

## STATUS BYTE AND REQUEST FOR SERVICE (RQS):

A bit in the STATUS BYTE called RQS (request for service) sets whenever an event occurs that requires the attention of the computer. The RQS bit can set if any of the summary bits from

# REMOTE OPERATION

the MEASUREMENT EVENT, OPERATION EVENT, STANDARD EVENT or QUESTIONABLE EVENT registers are set, or if an error message exists. The STATUS ENABLE register is a mask register that is used to allow any of these conditions to set the RQS bit. Setting any bit in the STATUS ENABLE register to “1” will allow a corresponding “1” in the STATUS BYTE register to set the RQS bit. These registers are depicted in Figure 4-4.

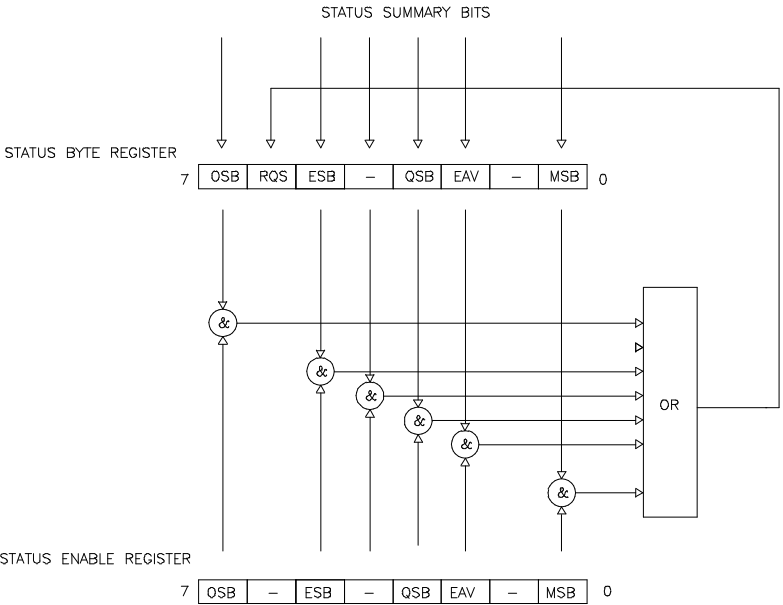

Figure 4-4  
Status Byte and Enable registers

## REMOTE OPERATION

OSB - Operation Summary Bit:	If any of the bits in the OPERATION EVENT register set, and their respective enable bits are set, the Operation Summary Bit (OSB) will set.
ESB - Event Summary Bit:	If any of the bits in the STANDARD EVENT register set, and their respective enable bits are set, the Event Summary Bit (ESB) will set.
QSB - Questionable Summary Bit:	If any of the bits in the QUESTIONABLE EVENT register set, and their respective enable bits are set, the Questionable Summary Bit (QSB) will set.
MSB - Measurement Summary Bit:	If any of the bits in the MEASUREMENT EVENT register set, and their respective enable bits are set, the Measurement Summary Bit (MSB) will set.
EAV - Error Available:	This bit sets any time there is an error message available in the error buffer.
RSQ - Request For Service:	If any of the other bits in the STATUS BYTE are set, and their respective enable bits are set in the STATUS ENABLE register, the Request For Service (RQS) will set.

## REMOTE OPERATION

### STANDARD EVENT REGISTER:

If any of these bits set, and their respective enable bits are set, the Event Summary Bit (ESB) will set in the STATUS BYTE.

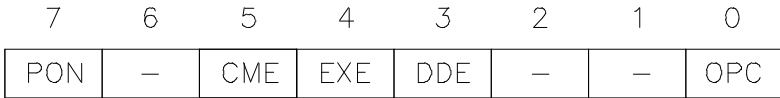

Figure 4-5  
Standard Event register

**PON -**  
Power On: Indicates that the meter was turned off and on since the last communication.

**CME -**  
Command Error: Indicates that there was a syntax or spelling error in the command, or the command received is not supported.

**EXE -**  
Execution Error: Indicates that the meter detected an error while attempting to execute a command.

**DDE -**  
Device Dependent Error: Indicates that the meter did not operate properly due to some internal error.

**OPC -**  
Operation Complete: Indicates that all requested operations have been completed.

## REMOTE OPERATION

### MEASUREMENT EVENT REGISTER:

If any of these bits set, and their respective enable bits are set, the Measurement Summary Bit (MSB) will set in the STATUS BYTE.



Figure 4-6  
Measurement Event register

ROF - Reading Overflow: Indicates that the present reading exceeds the present measurement range.

RAV - Reading Available: Indicates a reading was acquired and processed.

### OPERATION EVENT REGISTER:

If any of these bits set, and their respective enable bits are set, the Operation Summary Bit (OSB) will set in the STATUS BYTE.



Figure 4-7  
Operation Event register

MEAS - Measure mode: Indicates the meter is in the process of acquiring and processing a reading.

## REMOTE OPERATION

### QUESTIONABLE EVENT REGISTER:

If any of these bits set, and their respective enable bits are set, the Questionable Summary Bit (QSB) will set in the STATUS BYTE.

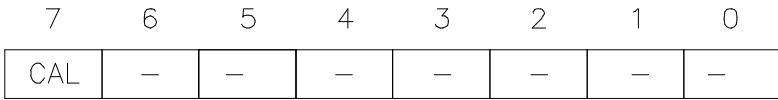

Figure 4-8  
Questionable Event register

CAL - Indicates that an invalid calibration constant was detected during power up or when the probe was installed. The instrument will instead use a default parameter. This bit will clear once the meter and probe have been successfully calibrated.

NOTE: Meter specifications are not guaranteed when the CAL bit is set !

### “COMMON” COMMAND SYNTAX:

The “common” commands are recognized and acted upon in a similar manner by all instruments that follow the IEEE-488.2 standard, whether a DVM, scope, frequency meter, gaussmeter, etc. These are the syntax rules:

1) A common command always begins with an asterisk character (\*) followed by a three or four character acronym and possibly one other parameter. For instance the command to clear the event registers is \*CLS.

## REMOTE OPERATION

2) The commands are not case sensitive. For instance the \*CLS, \*cls and \*cLS commands are identical.

3) If there is a fourth character in the acronym it will always be a question mark (?) and indicates that information is being requested from the instrument. For instance a command to read the model number and manufacturer of the instrument is \*IDN?.

4) If a parameter follows a command it must be separated from the acronym by one space. The parameter is the ASCII representation of an integer. For instance if the parameter to be sent is binary 1100, the actual parameter sent would be the two ASCII characters 12, since binary 1100 = decimal 12. If you were to send the four ASCII characters 1100 it would be interpreted as decimal 1100 (eleven hundred).

5) A number returned from the instrument is an ASCII representation of a number. For instance if the instrument returns the ASCII string 345 the number is decimal 345 (three hundred forty five), which translates to 159 hex.

6) Multiple commands can be sent in one string. The commands must be separated by semicolons (;). For instance, \*CLS;\*IDN? first clears the event registers and then requests model and manufacturer information. If more than one of the commands in the string requests information from the instrument, the instrument's response will also have semicolons separating the responses, such as 345;0;10.



## REMOTE OPERATION

### “COMMON” COMMANDS:

<b>ACRONYM</b>	<b>NAME</b>	<b>BRIEF DESCRIPTION</b>
*CLS	Clear status	Clear all event registers and error buffer.
*ESE <NRf>	Program event enable	Program standard event enable register.
*ESE?	Event enable query	Read standard event enable register.
*ESR?	Event status query	Read standard event register and clear it.
*IDN?	Identification query	Return manufacturer, model number, software version number.
*OPC	Set operation complete	Set the Operation Complete bit in the standard event register after all commands have been executed.
*OPC?	Operation complete query	Returns an ASCII “1” after all commands have been executed.
*OPT?	Option identification query	Returns information about the attached Hall probe.
*SRE <NRf>	Program Status enable	Program STATUS enable register.
*SRE?	Status enable query	Read STATUS enable register.
*STB?	Status byte query	Read status byte register.

Table 4-1  
Common command summary

## REMOTE OPERATION

- \*CLS - CLEAR STATUS** Clears the MEASUREMENT EVENT, OPERATION EVENT, STANDARD EVENT and QUESTIONABLE EVENT registers, but not their enable registers. It also clears the error buffer.
- \*ESE <NRf> - PROGRAM STANDARD EVENT ENABLE REGISTER** A set bit in the STANDARD EVENT ENABLE register allows its corresponding event to set the ESB (event summary bit) in the STATUS BYTE register. <NRf> is an ASCII string representing an integer mask. For instance a value of 45 decimal is the same as binary 00101101, thus setting bits 5, 3, 2 and 0 in the enable register.
- \*ESE? - STANDARD EVENT ENABLE REGISTER QUERY** Returns the contents of the STANDARD EVENT ENABLE register.
- \*ESR? - STANDARD EVENT REGISTER QUERY** Returns the contents of the STANDARD EVENT register.
- NOTE:** The STANDARD EVENT register is cleared after an \*ESR? command.
- \*IDN? - IDENTIFICATION QUERY** Returns the following string GAUSS / TESLA Meter, Rx.x. The Rx.x string is the firmware revision level, where x.x is a decimal number, such as 1.1.
- \*OPC - SET OPERATION COMPLETE** Causes the OPC (operation complete) bit to set in the STANDARD EVENT register when all commands have been executed.

## REMOTE OPERATION

- \*OPC? -**  
OPERATION  
COMPLETE  
QUERY
- Causes the OPC (operation complete) bit to set in the STANDARD EVENT register and returns an ASCII "1" when all commands have been executed.
- \*OPT? -**  
OPTION  
IDENTIFICATION  
QUERY
- Returns a string that identifies the model number and serial number of the Hall probe. The model number will always be 12 characters in length including trailing spaces, such as HTD61-0608. Following the model number will be a comma (,). Next will be the serial number, which will always be ten characters in length including trailing spaces, such as 9623004. If no probe is attached or can't be identified the string will default to "UNDEFINED ,0".
- \*SRE <NRf> -**  
PROGRAM  
STATUS ENABLE  
REGISTER
- A set bit in the STATUS ENABLE register allows its corresponding event to set the RQS (request for service) in the STATUS BYTE register. <NRf> is an ASCII string representing an integer mask. For instance a value of 45 decimal is the same as binary 00101101, thus setting bits 5, 3, 2 and 0 in the enable register.
- \*SRE? -**  
STATUS ENABLE  
REGISTER QUERY
- Returns the contents of the STATUS ENABLE register.

## REMOTE OPERATION

**\*STB?** -  
STATUS BYTE  
QUERY

Returns the contents of the STATUS  
BYTE register.

NOTE: The STATUS BYTE register is not cleared after an \*STB? command. Other registers and buffers must be cleared for the bits in the STATUS BYTE register to be cleared.

### SCPI COMMAND SYNTAX:

The SCPI commands go one step farther than IEEE-488.2 and provide a language protocol and defines a standard set of commands to program every aspect of the instrument. These are the syntax rules:

- 1) The first character of any command string is a colon (:).
- 2) The commands are not case sensitive. For instance the :MEASURE, :measure and :MEASure commands are identical.
- 3) A question mark (?) in a command means that the command is requesting information from the instrument. This is called a query command.
- 4) For any command there is a short and long spelling of the command. Use the following rules for the short version:
  - a) If the length of the command is four letters or less, there is no short version.

## REMOTE OPERATION

b) If the command has more than four letters and the fourth letter is a vowel, drop it and all letters that follow it. For instance the command :RESET can be shortened to :RES.

c) If the command has more than four letters and the fourth letter is a consonant, drop all letters that follow it. For instance the command :MEASURE can be shortened to :MEAS.

d) If the command contains a question mark (?) or a non-optional parameter it must be included after the short form version. For instance a query command of :CONDITION? can be shortened to :COND?.

e) The use of anything other than the short or long version of a command is not permitted. For instance both the :MEASURE and :MEAS commands are acceptable, but :MEASU is not.

5) If a parameter follows a command it must be separated from the command by one space.

6) Multiple commands can be sent in one string. The commands must be separated by semicolons (;). A colon (:) must still precede each command. If more than one of the commands in the string requests information from the instrument, the instrument's response will also have semicolons separating the responses, such as 345;0;10.

## REMOTE OPERATION

### SCPI COMMANDS:

In the following discussion the commands are written such that the short form of the command is written in UPPER CASE letters and the remainder of the command is written in lower case letters. Either form can be used.

If parameters are required they will appear within <> brackets. An <n> parameter is a single ASCII digit. <NRf> is usually a multiple digit number.

The meter supports a subset of the available SCPI commands. However, there are some functions that are not supported with standard SCPI commands. In these cases these special commands are patterned after other SCPI commands that are similar in function.

<b>ERROR MESSAGE COMMANDS</b>	<b>DESCRIPTION</b>
:SYSTem:ERRor?	Retrieve error message
:SYSTem:CLEar	Clear error message

<b>STATUS REGISTER COMMANDS</b>	<b>DESCRIPTION</b>
:STATus:MEASurement:EVENT?	Query Measurement Event reg.
:STATus:OPERation:EVENT?	Query Operation Event reg.
:STATus:QUESTionable:EVENT?	Query Questionable Event reg.
:STATus:MEASurement:ENABLE <NRf>	Program Measurement Event Enable reg.

Table 4-2  
SCPI Command summary

## REMOTE OPERATION

:STATus:OPERation:ENABLE <NRf>	Program Operation Event Enable reg.
:STATus:QUESTionable:ENABLE <NRf>	Program Questionable Event Enable reg.
:STATus:MEASurement:ENABLE?	Query Measurement Event Enable reg.
:STATus:OPERation:ENABLE?	Query Operation Event Enable reg.
:STATus:QUESTionable:ENABLE?	Query Questionable Event Enable reg.
:STATus:MEASurement:CONDition?	Query Measurement Condition reg.
:STATus:OPERation:CONDition?	Query Operation Condition reg.
:STATus:QUESTionable:CONDition?	Query Questionable Condition reg.
:STATus:PRESet	Clear all event registers.

UNITS COMMANDS	DESCRIPTION
:UNIT:FLUX:AC:GAUSSs	Program ac gauss units
:UNIT:FLUX:AC:TESLa	Program ac tesla units
:UNIT:FLUX:AC:AM	Program ac ampere per meter units
:UNIT:FLUX:DC:GAUSSs	Program dc gauss mode
:UNIT:FLUX:DC:TESLa	Program dc tesla units

Table 4-2 (cont.)  
SCPI Command summary

## REMOTE OPERATION

:UNIT:FLUX:DC:AM	Program dc A-M units
:UNIT:FLUX?	Query flux units setting
:UNIT:TEMP:C	Program degrees C units
:UNIT:TEMP:F	Program degrees F
:UNIT:TEMP?	Query temperature units setting

RANGE COMMANDS	DESCRIPTION
:SENSe:FLUX:RANGe:AUTO	Program auto range
:SENSe:FLUX:RANGe <n>	Program fixed range
:SENSe:FLUX:RANGe?	Query range setting

HOLD COMMANDS	DESCRIPTION
:SENSe:HOLD:STATe <n>	Program hold mode
:SENSe:HOLD:STATe?	Query hold mode setting
:SENSe:HOLD:RESet	Reset presently held value

ZERO / RELATIVE COMMANDS	DESCRIPTION
:SYSTem:AZERo	Initiates an automatic zero operation
:SYSTem:ARELative:STATe <n>	Program relative mode
:SYSTem:ARELative:STATe?	Query relative mode setting

MEASUREMENT COMMANDS	DESCRIPTION
:MEASure:FLUX?	Obtain flux density reading.



## REMOTE OPERATION

:MEASure: TEMP?	Obtain temperature reading
-----------------	----------------------------

DISPLAY FORMAT COMMANDS	DESCRIPTION
:DISPlay:FORMat <n>	Formats upper and lower readouts
:DISPlay:FORMat?	Query display format setting

Table 4-2 (cont.)  
SCPI Command summary

### ERROR MESSAGES AND COMMANDS:

If an error occurs a message is placed in the error buffer. The message will contain a number, a comma (,) and a brief description of the error. Negative (-) numbers are used for SCPI defined messages while positive (+) numbers relate specifically to the meter.

Each time the buffer is read the error message is removed from the buffer. If no error exists the message "0, No error" will be returned. However, if the buffer contains any other message, and a new error occurs before the old one is read or cleared, the new message will be lost.

There are certain error status bits that will set in the STANDARD EVENT register. These bits provide general error indications. The error message will provide more detailed information about the errors.

The error buffer can be read and cleared with the following commands:

**:SYSTem:ERRor?** Returns the error message and clears the

## REMOTE OPERATION

error buffer.

**:SYSTEM:CLEAr** Clears the error buffer.

If the meter detects an error in the command string (a spelling error, a command that is not supported or a numerical value that is incorrect) the meter will not execute the command. If the error is detected in the middle of a multiple command string the command that contains the error and all commands that follow will not be executed. The user's program should always check the STATUS BYTE to determine if an error has occurred.

The possible error messages are:

- 0, NO ERROR
- 201, HARDWARE ERROR
- 120, NUMERIC DATA ERROR
- 224, ILLEGAL PARAMETER ERROR
- 363, INPUT BUFFER OVERRUN
- 103, INVALID SEPARATOR
- 102, SYNTAX ERROR
- 100, COMMAND ERROR

Most of these errors are associated with incorrect command settings (wrong characters, illegal numeric values, etc.). The "hardware error" is not an indication of a circuit failure. Rather, a command is requesting an operation that is not supported by the existing equipment. For example requesting a temperature reading from a probe that does not support temperature compensation.

## REMOTE OPERATION

### STATUS COMMANDS:

The STATUS commands control and query the MEASUREMENT EVENT, OPERATION EVENT and QUESTIONABLE EVENT registers.

<b>:STATus:MEASurement:EVENT?</b>	Returns the contents of the specified EVENT register, then <u>clears the register contents.</u>
<b>:STATus:OPERation:EVENT?</b>	
<b>:STATus:QUEStionable:EVENT?</b>	
<b>:STATus:MEASurement:ENABLE &lt;NRf&gt;</b>	Programs the specified EVENT ENABLE register with the value <NRf>. <NRf> is an ASCII string representing an integer mask. For instance a value of 45 decimal is the same as binary 00101101, thus setting bits 5, 3, 2 and 0 in the enable register.
<b>:STATus:OPERation:ENABLE &lt;NRf&gt;</b>	
<b>:STATus:QUEStionable:ENABLE &lt;NRf&gt;</b>	
<b>:STATus:MEASurement:ENABLE?</b>	Returns the contents of the specified EVENT ENABLE register.
<b>:STATus:OPERation:ENABLE?</b>	
<b>:STATus:QUEStionable:ENABLE?</b>	

## REMOTE OPERATION

**:STATus:MEASurement:CONDition?**  
**:STATus:OPERation:CONDition?**  
**:STATus:QUEStionable:CONDition?**

Returns the contents of the specified EVENT CONDITION register. The EVENT CONDITION register is a real-time register reflecting the state of the meter at the time of the read. Some conditions could happen very quickly and could be missed by this query. It is often better to rely on the contents of the EVENT register since it latches the event until cleared by a specific command.

**:STATus:PRESet**

Clears all EVENT ENABLE registers.

## REMOTE OPERATION

### UNITS COMMANDS:

These commands select flux density readings in either gauss, tesla or ampere per meter, for either static fields (dc) or alternating fields (ac). If a temperature compensated probe is attached additional commands select temperature readings in degrees Celcius (°C) or degrees Fahrenheit (°F). See Section-3 for more information.

<b>:UNIT:FLUX:AC:GAUSS</b>	Specifies ac flux density readings in gauss.
<b>:UNIT:FLUX:AC:TESLA</b>	Specifies ac flux density readings in tesla.
<b>:UNIT:FLUX:AC:AM</b>	Specifies ac flux density readings in ampere/meter.
<b>:UNIT:FLUX:DC:GAUSS</b>	Specifies dc flux density readings in gauss.
<b>:UNIT:FLUX:DC:TESLA</b>	Specifies dc flux density readings in tesla.
<b>:UNIT:FLUX:DC:AM</b>	Specifies dc flux density readings in ampere/meter.
<b>:UNIT:FLUX?</b>	Returns an ASCII string representing the present mode setting for the meter. The ASCII string can be DC GAUSS, AC GAUSS, DC TESLA, AC TESLA, AC AM or DC AM.

## REMOTE OPERATION

<b>:UNIT:TEMP:C</b>	Specifies temperature readings in degrees Celcius (°C).
<b>:UNIT:TEMP:F</b>	Specifies temperature readings in degrees Fahrenheit (°F).
<b>:UNIT:TEMP?</b>	Returns an ASCII F or C indicating that temperature readings are in degrees Fahrenheit (°F) or Celcius (°C).

Note: The following conditions will generate a “-201, hardware error” message:

- 1) If a “:UNIT:TEMP” command is issued but the attached probe does not support temperature measurement.
- 2) If the meter has been configured to measure only temperature (via the “:DISPlay:FORMat” command), and a “:UNIT:FLUX” command is issued.
- 3) If the meter has been configured to measure only flux density (via the “:DISPlay:FORMat” command), and a “:UNIT:TEMP” command is issued.

It is always best to configure the meter with the “:DISPlay:FORMat” command and then issued the appropriate “:UNIT” command.

## REMOTE OPERATION

### RANGE COMMANDS:

These commands select either a fixed range or AUTO range. See Section-3 for more information.

- :SENSe:FLUX:RANGe:AUTO** Selects the AUTO RANGE function.
- :SENSe:FLUX:RANGe <n>** Selects a fixed range <n>, where n =
- 0 for the lowest range
  - 1 for the middle range
  - 2 for the highest range
- :SENSe:FLUX:RANGe?** Returns an ASCII digit representing the present range setting for the meter, as follows:
- 0 for the lowest range
  - 1 for middle range
  - 2 for highest range

**Note:** The actual ranges available depend upon the type of Hall probe being used. See the specifications section for information. For instance, the lowest range for a standard probe is 300G (30 mT) full scale, whereas the lowest range for a high sensitivity probe is 3 G (300  $\mu$ T) full scale

## REMOTE OPERATION

### HOLD COMMANDS:

These commands select one of the HOLD modes or reset the presently held reading. See Section-3 for more information.

**:SENSe:HOLD:STATe <n>** Selects the HOLD function, where <n> is a single ASCII digit, as follows:

0 = All HOLD modes turned off.

1 = MIN HOLD on.

2 = MAX HOLD on.

3 = PEAK HOLD on.

4= FAST PEAK HOLD on

**:SENSe:HOLD:STATe?** Returns an ASCII digit representing the present HOLD mode setting, as follows:

0 = All HOLD modes turned off.

1 = MIN HOLD on.

2 = MAX HOLD on.

3 = PEAK HOLD on.

4= FAST PEAK HOLD on

**:SENSe:HOLD:RESet** This command resets the presently held reading.



### ZERO COMMAND

This command initiates an automatic ZERO operation. See Section-3 for more information.

**:SYSTem:AZERo** Automatic zeroing is initiated upon receipt of this command.

**Note:** If the meter has been configured to measure only temperature (via the " :DISPlay:FORMat " and a zero command is used a " -201, hardware error" message will be generated.

### RELATIVE COMMANDS

These commands control the RELATIVE function. See Section-3 for more information.

**:SYSTem:ARELative:STATe <n>** The relative function is turned off when <n> is 0. When <n> is 1 the relative function is turned on, using the previously generated relative value, if any. When <n> is 2 the relative function is turned on and an automatic relative operation is initiated.

**:SYSTem:ARELative:STATe?** Returns a single ASCII digit indicating the on / off state of the relative function. A 0 indicates the relative function is turned off. A 1 indicates the relative function is turned on.

# REMOTE OPERATION

### MEASUREMENT COMMAND:

This command acquires a new flux density reading.

**:MEASure:FLUX?** This command returns the latest flux density reading. The returned string will contain a signed real number and a unit indicator (G, T, or A/m). If in the ac mode the reading will not contain a polarity character (+ or -).

The ranges of possible readings for the various units of measure are:

0.0G to 29990G  
0.00000T to 2.999T  
0A/m to 2,388,000A/m

**:MEASure:TEMP?** This command returns the largest temperature reading. A temperature compensated probe must be attached for this command to be accepted. The returned string will contain a signed real number and a unit indicator (C or F).

The ranges of possible readings for the various units of measurements are:

-40.0°C to +100.0°C  
-40.0°F to +212.0°F

**Note:** The meter must be configured to measure flux density and/or temperature prior to requesting a measurement, otherwise a “-201, hardware error” message will occur. See the “:DISPlay:FORMat” command for details.

**Note:** If a “:MEASure:TEMP?” command is issued but the attached probe does not support temperature measurement, a

## REMOTE OPERATION

"-201, hardware error" message will be generated.

### DISPLAY FORMAT COMMANDS:

This command contains the type of information displayed on the upper and lower readouts.

**:DISPlay:FORMat <n>** Configures the display format, where <n> is a single ASCII digit, as follows:

0= Flux density only (upper readout)

1= Temperature only (upper readout).

2=Flux density (upper readout and temperature (lower readout).

**:DISPlay:FORMat?** Returns a single ASCII digit indicating the format of the display:

0= Flux density only (upper readout)

1= Temperature only (upper readout).

2=Flux density (upper readout and temperature (lower readout).

### INTERMIXING “COMMON” AND SCPI COMMANDS:

As mentioned earlier a string sent to the instrument can contain more than one command as long as the commands are separated by semicolons(;). “Common” and SCPI commands can be intermixed. For instance the string

```
*CLS;;UNIT:FLUX:DC:TESLA;;MEASure:FLUX?
```

is valid, first clearing the instrument’s event and error registers, then programming it to supply readings in tesla in the dc mode and requesting the latest reading. The host system should be prepared to receive the reading immediately after transmitting this command string to the meter.

### USING QUERY COMMANDS:

When any query command is issued the meter will send its response back immediately. However if a query command is part of a multiple command string the meter will transmit the response after all commands within the string have been executed. For instance here is such a string:

```
:UNIT:FLUX:DC:GAUSS;;MEAS:FLUX?;;UNIT:FLUX:DC:TESLA;  
:MEAS:FLUX? <LF>
```

In this string the meter is programmed for DC GAUSS mode and a measurement is requested. Then the meter is programmed for DC TESLA mode and another measurement is requested. When the meter has finished executing the entire command string it will transmit a string similar to this:

```
+1892G;+0.1892T;<LF>
```

## REMOTE OPERATION

### USING THE OPERATION COMPLETE STATUS:

There are several ways to determine if the meter has executed a command. If the command string contains a query command the program can simply wait for the meter to transmit its response. But if the query command contains an error the command may never be executed. Further, some commands do not require a response. The best way to handle all situations is to issue the \*OPC? command once prior to sending any other commands. This will cause the meter to always transmit an ASCII "1" each time it receives the (LF) character. If the command string contains one or more query commands, the "1" will be appended to the end of the response separated by a semicolon (;). For instance the response to the command string

```
*OPC?;:UNIT:FLUX:AC:GAUSS <LF>
```

would be "1;<LF>", whereas the response to a command string containing a query

```
*OPC?;:MEAS:FLUX? <LF>
```

might be "+221.3G;1;<LF>".

### EXAMPLE PROGRAM:

Of the many programming languages available such as C, Pascal, BASIC, Fortran, etc., BASIC is probably the best known and understood by the most people. For this reason the following example program was written in Microsoft MS-DOS Q-BASIC for 80x86 style personal computers.

The following program is provided as a guide for programmers who wish to develop their own programs. It was written for clarity and is not necessarily the most efficient in terms of speed or size. Not all of the commands are demonstrated, but enough are used to serve as a general guide for using the other commands.

```
DECLARE SUB METER.I.O (expect.response%, timeout%)
DIM SHARED METER.CMD$, METER.RESP$, METER.ERROR%

CLS
PRINT "*****"
PRINT "          RS-232 DEMONSTRATION PROGRAM "
PRINT "*****"
PRINT "This program demonstrates the use of the RS-232 serial port"
PRINT "This Q-BASIC program was intended for using the COM2 serial port"
PRINT " To use another comm port change the OPEN statement near the start"
PRINT " of the program."
PRINT ""
PRINT "This program can be used to verify the connection between the meter"
PRINT " and computer as well as provide a template for system programmers"
PRINT " who wish to create their own programs. You can use a straight-thru"
PRINT " cable from the meter to the PC. See the user's manual for more"
PRINT " information."
PRINT
PRINT "Turn the meter on wait for measurement to begin."
PRINT " position. Press any key to continue...";

DO: LOOP UNTIL INKEY$ <> "": CLS

PRINT "Initializing COM2 port..."
OPEN "COM2:2400,N,8,1,CS,DS,CD" FOR RANDOM AS #1
```

## REMOTE OPERATION

*Now that the COM-2 port has been opened an attempt is made to communicate with the meter. The \*OPC? command is sent which should cause the meter to send back a "1;". If no response is received an error message is displayed and the program is terminated.*

```
ON ERROR GOTO TRY.AGAIN
```

```
'=====
'Attempt to communicate with meter.
'=====
PRINT "Verifying interface..."
METER.CMD$ = "**OPC?": CALL METER.I.O(1, 1)

IF METER.ERROR% = 1 THEN
    PRINT "Meter did not respond as requested. Please check your"
    PRINT " interface cable. Make sure it is connected to the COM2"
    PRINT " port on your computer."
    END
END IF
```

*Now that the communications link between meter and computer has been established the I.D. information for the meter and probe is requested and displayed.*

```
'=====
'Request meter / probe I.D. information and display it.
'=====
PRINT "Retrieving meter I.D. information...": PRINT
METER.CMD$ = "**IDN?;*OPT?": CALL METER.I.O(1, 1)
POS1% = INSTR(METER.RESP$, ";")
PRINT "Device = "; LEFT$(METER.RESP$, POS1%-1);
POS2% = INSTR(POS1%+1, METER.RESP$, ";")
PRINT " Revision = ";
PRINT MID$(METER.RESP$, POS1%+1, (POS2%-POS1%-1));
POS1% = INSTR(POS2%+1, METER.RESP$, ";")
PRINT " Probe Model = ";
PRINT MID$(METER.RESP$, POS2%+1, (POS1%-POS2%-1));
POS2% = INSTR(POS2%+1, METER.RESP$, ";")
PRINT " Probe Serial = ";
PRINT MID$(METER.RESP$, POS1%+1, (POS2%-POS1%-1))
PRINT
```



## REMOTE OPERATION

```
PRINT "Press any key to continue....."  
DO: LOOP UNTIL INKEY$ <> "" : CLS
```

*The user is now instructed to insert the probe into the zero flux chamber or any dc field lower than 30 mT (300G). The meter will be instructed to perform an automatic zeroing, which will take several seconds to complete. If the meter reports an error the error message will be displayed.*

```
'=====
'Demonstrate the AUTO-ZERO function.
'=====
PRINT "The automatic zeroing function will now be demonstrated."
PRINT
PRINT "Insert the probe into the zero flux chamber or in any magnetic"
PRINT " field less than 30 mT (300 G)."  
PRINT
PRINT "Press any key when ready.....": PRINT

DO: LOOP UNTIL INKEY$ <> ""

PRINT "AUTO ZERO is in process...please wait...."  
METER.CMD$ = ":SYSTEM:AZERO"  
CALL METER.I.O(1, 15)  
METER.CMD$ = ":SYSTEM:ERR?": CALL METER.I.O(1, 1)  
POS1% = INSTR(METER.RESP$, ",")  
IF VAL(LEFT$(METER.RESP$, POS1% - 1)) <> 0 THEN  
  CLS:BEEP  
  PRINT "The meter has reported an error of "; METER.RESP$  
  PRINT  
  PRINT "Press any key to continue....."  
  DO: LOOP UNTIL INKEY$ <> "" : CLS  
END IF
```

## REMOTE OPERATION

*The meter is now set to the dc tesla mode with a fixed range of 300 mT*

```
.'  
=====
```

```
'Program meter for DC-TESLA measurement on the 300 mT range.  
=====
```

CLS

```
PRINT "Programming meter for DC-TESLA mode, 300 mT range..."
```

```
METER.CMD$ = ":SYSTEM:CLEAR": CALL METER.I.O(1, 1)
```

```
METER.CMD$ = ":UNIT:FLUX:DC:TESLA;;SENSE:FLUX:RANGE 1"
```

```
CALL METER.I.O(1, 2)
```

*Flux density readings are acquired and displayed on a continuous basis. The user can move the probe in and out of a magnetic field in order to observe the changes in the flux density readings.*

```
'=====
```

```
'Acquire measurements and display them until the user presses a key.  
=====
```

LOCATE 10, 1

```
PRINT "Move the probe near a dc magnetic field and observe the  
PRINT " change in the present flux density reading."
```

```
PRINT
```

```
PRINT "Press any key when finished....."
```

DO

```
METER.CMD$ = "MEAS:FLUX?": CALL METER.I.O(1, 2)
```

```
POS1% = INSTR(METER.RESP$, ",")
```

```
LOCATE 15, 15
```

```
PRINT "Present flux density = "; LEFT$(METER.RESP$, POS1% - 1)
```

```
METER.CMD$ = ":SYSTEM:ERR?": CALL METER.I.O(1, 1)
```

```
POS1% = INSTR(METER.RESP$, ",")
```

```
IF VAL(LEFT$(METER.RESP$, POS1% - 1)) <> 0 THEN
```

```
CLS: BEEP
```

```
POS1% = INSTR(METER.RESP$, ",")
```

```
PRINT "The meter has reported an error of ";
```

```
PRINT LEFT$(METER.RESP$, POS1% - 1)
```

```
PRINT
```

```
PRINT "Press any key to continue....."
```

## REMOTE OPERATION

```
DO: LOOP UNTIL INKEY$ <> ""
EXIT DO
END IF
```

```
LOOP UNTIL INKEY$ <> ""
END
```

```
TRY.AGAIN:
RESUME NEXT                                'Comm error trap.
```

*This subroutine handles the communications between the meter and the computer. The header contains specific information.*

```
SUB METER.I.O (expect.response%, timeout%)
'=====
'                METER INPUT / OUTPUT SUBROUTINE
'=====
' This subroutine transmits the contents of the global buffer
' <METER.CMD$> to the meter, followed by the line feed terminator.
'
' If the variable <expect.response%> is non-zero, the subroutine will
' wait for a response from the meter and store it in the global buffer
' <METER.RESP$>. The program will wait for <timeout%> seconds for
' a response. If no response is received the command will be issued
' again. If still no response the global variable <METER.ERROR%> will
' be set to 1 and a normal return will be made.
'=====
RETRY = 2: METER.ERROR% = 0                'Clear error flag.

DO UNTIL EOF(1) = -1
METER.RESP$ = INPUT$(LOC(1), #1) 'Remove any residual bytes
LOOP                               ' from the input buffer.

SEND.COMMAND:
METER.RESP$ = ""                    'Null response buffer.
PRINT #1, METER.CMD$ + CHR$(10);    'Send command string
                                     ' followed by a line feed.

IF expect.response% = 0 THEN EXIT SUB 'Return if no response
                                     ' expected.
```

## REMOTE OPERATION

RESET.TIMER:

```
START.TIME = TIMER
```

'Store as many characters as are in the input buffer. If one of them ' is the line feed character return to caller with the response in the '<METER.RESP\$> buffer. If no response is received within '<timeout%> seconds, try again. If still no response, set '<METER.ERROR%> to non-zero and return.

LOOK.FOR.INPUT:

```
IF EOF(1) = -1 THEN
  IF (TIMER - START.TIME) > timeout% THEN
    RETRY = RETRY - 1
    IF RETRY <> 0 THEN          'Send command one more time.
      GOTO SEND.COMMAND
    ELSE
      METER.ERROR% = 1        'Report an error if no response.
      EXIT SUB
    END IF
  ELSE
    GOTO LOOK.FOR.INPUT
  END IF

ELSE
  METER.RESP$ = METER.RESP$ + INPUT$(LOC(1), #1)
  IF (INSTR(METER.RESP$, CHR$(10))) = 0 THEN GOTO
    RESET.TIMER
  EXIT SUB
END IF

END SUB
```

# WARRANTY

This instrument is warranted to be free of defects in material and workmanship. F.W. BELL's obligation under this warranty is limited to servicing or adjusting any instrument returned to the factory for that purpose, and to replace any defective parts thereof. This warranty covers instruments which, within one year after delivery to the original purchaser, shall be returned with transportation charges prepaid by the original purchaser, and which upon examination shall disclose to F.W. BELL's satisfaction to be defective. If it is determined that the defect has been caused by misuse or abnormal conditions of operation, repairs will be billed at cost after submitting an estimate to the purchaser.

F.W. BELL reserves the right to make changes in design at any time without incurring any obligation to install same on units previously purchased.

THE ABOVE WARRANTY IS EXPRESSLY IN LIEU OF ALL OTHER WARRANTIES EXPRESSED OR IMPLIED AND ALL OTHER OBLIGATIONS AND LIABILITIES ON THE PART OF F.W. BELL, AND NO PERSON INCLUDING ANY DISTRIBUTOR, AGENT OR REPRESENTATIVE OF F.W. BELL IS AUTHORIZED TO ASSUME FOR F.W. BELL ANY LIABILITY ON ITS BEHALF OR ITS NAME, EXCEPT TO REFER THE PURCHASER TO THIS WARRANTY. THE ABOVE EXPRESS WARRANTY IS THE ONLY WARRANTY MADE BY F.W. BELL. F.W. BELL DOES NOT MAKE AND EXPRESSLY DISCLAIMS ANY OTHER WARRANTIES, EITHER EXPRESSED OR IMPLIED, INCLUDING WITHOUT LIMITING THE FOREGOING, WARRANTIES OF MERCHANTABILITY OR FITNESS FOR A PARTICULAR PURPOSE OR ARISING BY STATUTE OR OTHERWISE IN LAW OR FROM A COURSE OF DEALING OR USAGE OR TRADE. THE EXPRESS WARRANTY STATED ABOVE IS MADE IN LIEU OF ALL LIABILITIES FOR DAMAGES, INCLUDING BUT NOT LIMITED TO CONSEQUENTIAL DAMAGES, LOST PROFITS OR THE LIKE ARISING OUT OF OR IN CONNECTION WITH THE SALE, DELIVERY, USE OR PERFORMANCE OF THE GOODS. IN NO EVENT WILL F.W. BELL BE LIABLE FOR SPECIAL, INDIRECT OR CONSEQUENTIAL DAMAGES EVEN IF F.W. BELL HAS BEEN ADVISED OF THE POSSIBILITY OF SUCH DAMAGES.

This warranty gives you specific legal rights, and you may also have other rights that vary from state to state.