

**Product number CA10716_BOOM-S**

Family	Boom	FWHM	20 degrees
Type	RefAssy	Efficiency	-
LED	MC-E	cd/lm	4.120
Color	Metal	Gerber File	Available
Diameter	22.2 mm	new tape, 0.2mm thicker	
Height	13.74 mm		
Style	Hexag		
Optic Material	PC		
Holder Material	-		
Fastening	Tape		
Status	On production		

**Product number CA10928_BOOM-M**

Family	Boom	FWHM	36 degrees
Type	RefAssy	Efficiency	-
LED	MC-E	cd/lm	2.010
Color	Metal	Gerber File	Available
Diameter	22.2 mm	new tape, 0.2mm thicker	
Height	13.74 mm		
Style	Hexag		
Optic Material	PC		
Holder Material	-		
Fastening	Tape		
Status	On production		

**Product number CA10929_BOOM-W**

Family	Boom	FWHM	54 degrees
Type	RefAssy	Efficiency	-
LED	MC-E	cd/lm	1.160
Color	Metal	Gerber File	Available
Diameter	22.2 mm	new tape, 0.2mm thicker	
Height	13.74 mm		
Style	Hexag		
Optic Material	PC		
Holder Material	-		
Fastening	Tape		
Status	On production		

**Product number CA12957_BOOM-XW**

Family	Boom	FWHM	70 degrees
Type	RefAssy	Efficiency	-
LED	MC-E	cd/lm	0.670
Color	White	Gerber File	Available
Diameter	22.2 mm		
Height	13.7 mm		
Style	Hexag		
Optic Material	HRPC		
Holder Material	-		
Fastening	Tape		
Status	On production		



PRODUCT DATASHEET

Boom series

last update 27/9/2012

NOTE: The typical divergence will be changed by different color, chip size and chip position tolerance. The typical total divergence is the full angle measured where the luminous intensity is half of the peak value.



PRODUCT DATASHEET

Boom series

last update 27/9/2012

GENERAL INFORMATION

- Product series especially designed & optimized for MC-E series of LEDs.
- Special care taken to make light distribution as uniform as possible.
- Reflector is made of aluminium coated PC (120 degrees of Celcius / 248 degrees of Fahrenheit) with protective lacquer (short term 100 degrees of Celcius / 212 degrees of Fahrenheit).
- Fastening to heat sink with a PU foam adhesive tape of automotive grade. Please find fastening details by clicking link: http://www.ledil.com/datasheets/DataSheet_TAPE.pdf

NOTE 1: We advise customer to ensure the suitability and sufficiency of the bond in the end product. For example, mechanical stress, vibration and holes on the surface of the circuit board weaken the strength of the tape.

NOTE 2: Assembly to the surface must be made straight, so the tape bonds constant and balanced with fastening surface. Slanted assembly might cause unbalanced bond to the surface. All surfaces where tape is applied must be clean, dry and free from grease and dirt.

If cleaning of PCB surfaces is needed, please follow strictly the cleaning instructions of your LED manufacturer - this is important as cleaning shall under no circumstances damage LEDs or other electronics components on the PCB.

Further note that optical components shall not be cleaned with any chemicals - only micro fiber cloth may be used to remove fingerprints or other traces from handling.

Relative intensity of CA12957_BOOM-MC-XW (Cree MC-E)

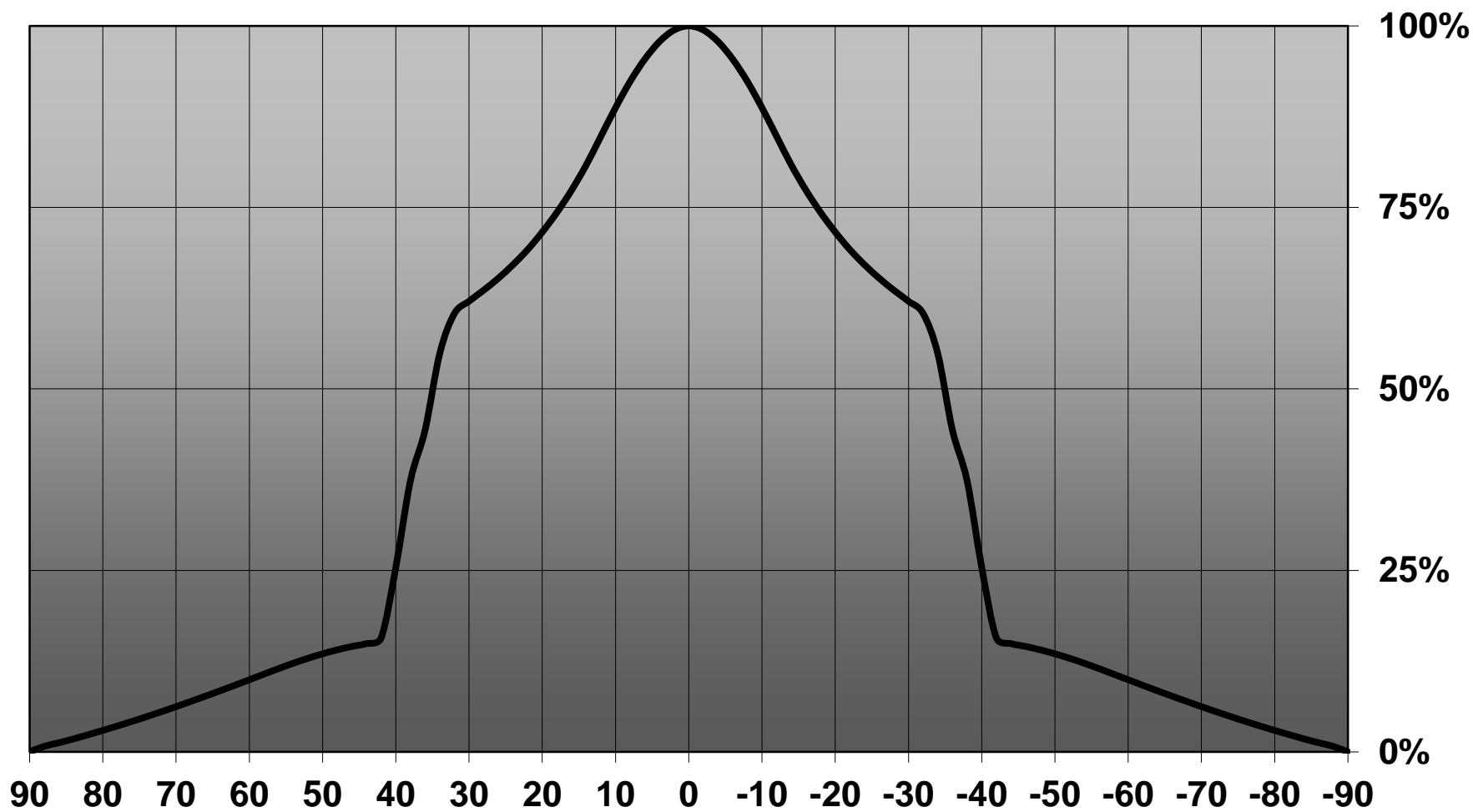

D

C

B

A

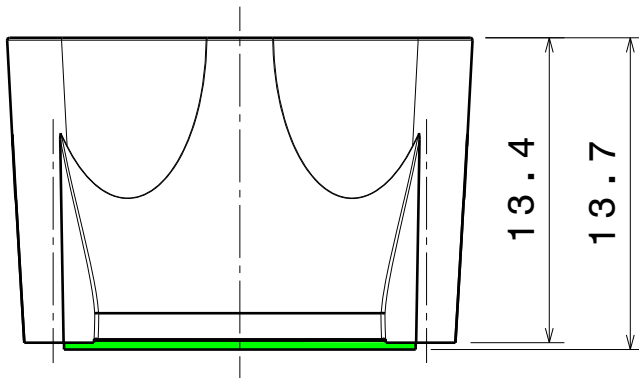
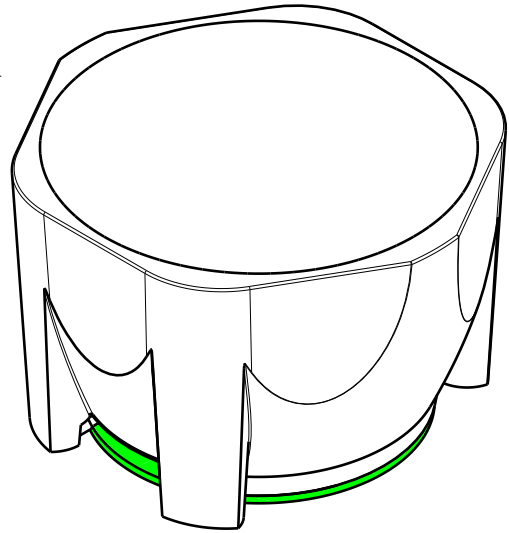
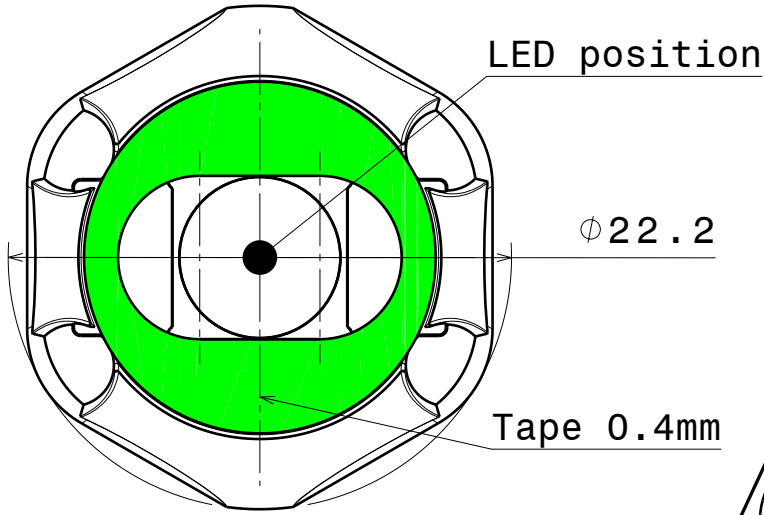

Isometric view
Scale: 3:1

Tolerances if not otherwise shown
According to DIN ISO 2768-1
Linear measures:
Up to 30mm class M, otherwise class C.
According to DIN ISO 2768-2
Form and position: class L

LEDiL LediL Oy
Salorankatu 10
FIN 24240 SALO
Finland

THIRD ANGLE PROJECTION:

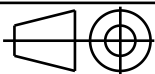

DRAWING TITLE

CA10716_BOOM-S

This drawing is the property
of LEDiL Oy. It may not be
reproduced, copied or
communicated without a written
agreement with LEDiL Oy."

SIZE PART NUMBER

A4

CA10716

SCALE 3:1 WEIGHT - SHEET 1/1

D

A

Ledil Oy CA10716_Boom-MC-S CA10716_Boom-MC-S / LDC (Linear)

Luminaire: Ledil Oy CA10716_Boom-MC-S CA10716_Boom-MC-S
Lamps: 1 x Cree MC-E (white)

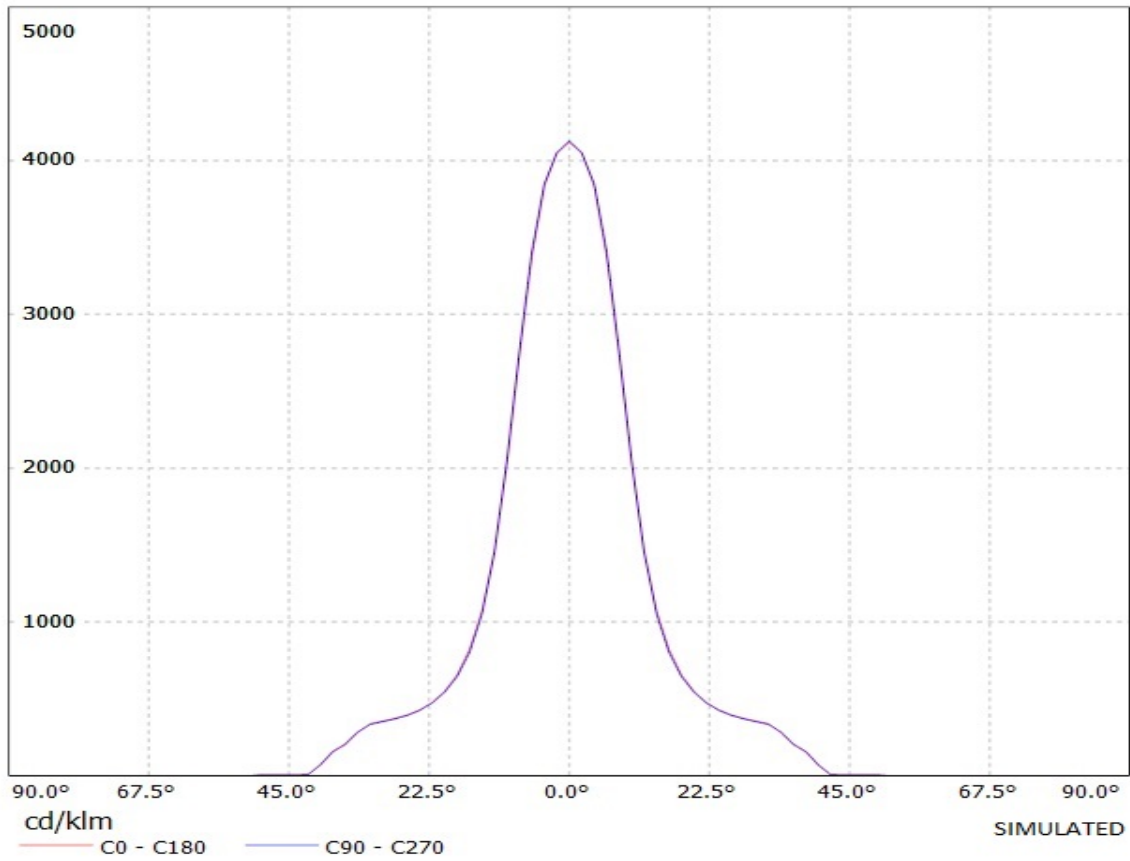

Ledil Oy CA10928_Boom-MC-M CA10928_Boom-MC-M / LDC (Linear)

Luminaire: Ledil Oy CA10928_Boom-MC-M CA10928_Boom-MC-M
Lamps: 1 x Cree MC-E (white)

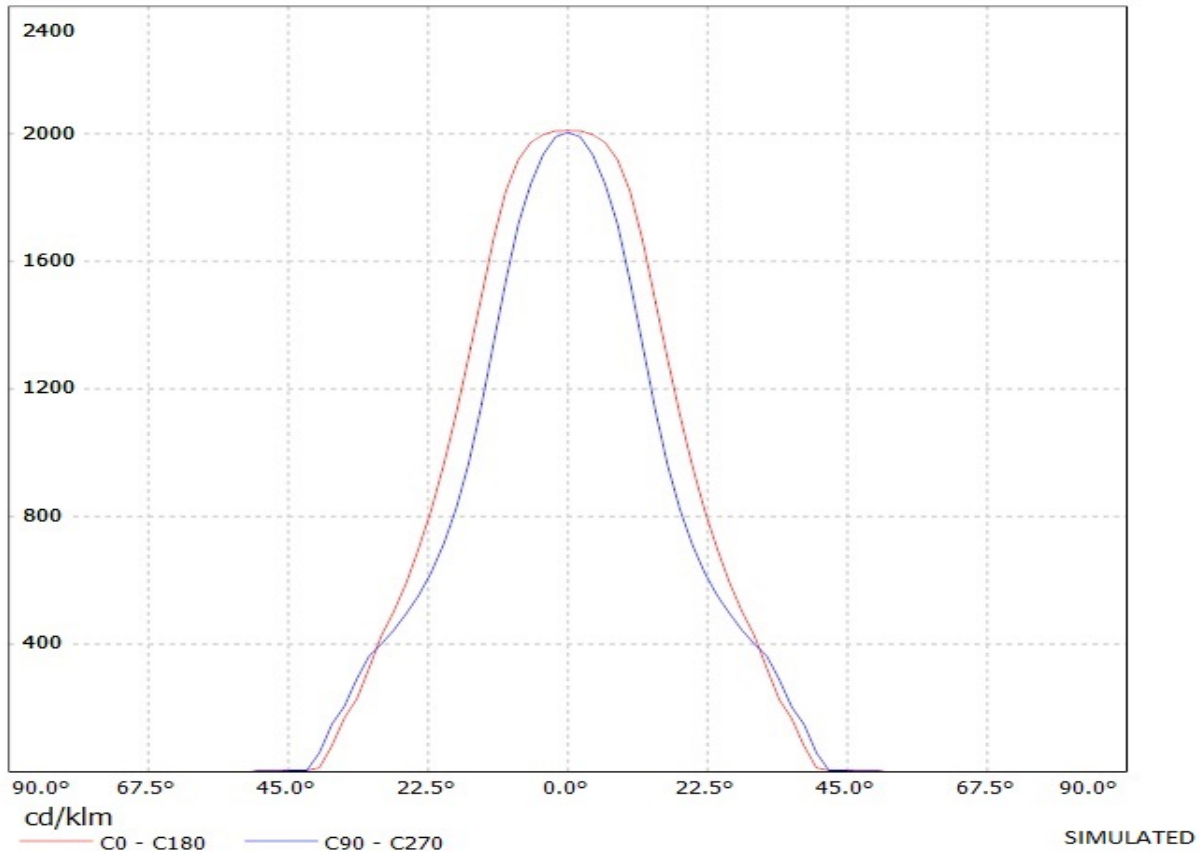

Ledil Oy CA10929_Boom-MC-W CA10929_Boom-MC-W / LDC (Linear)

Luminaire: Ledil Oy CA10929_Boom-MC-W CA10929_Boom-MC-W
Lamps: 1 x Cree MC-E (white)

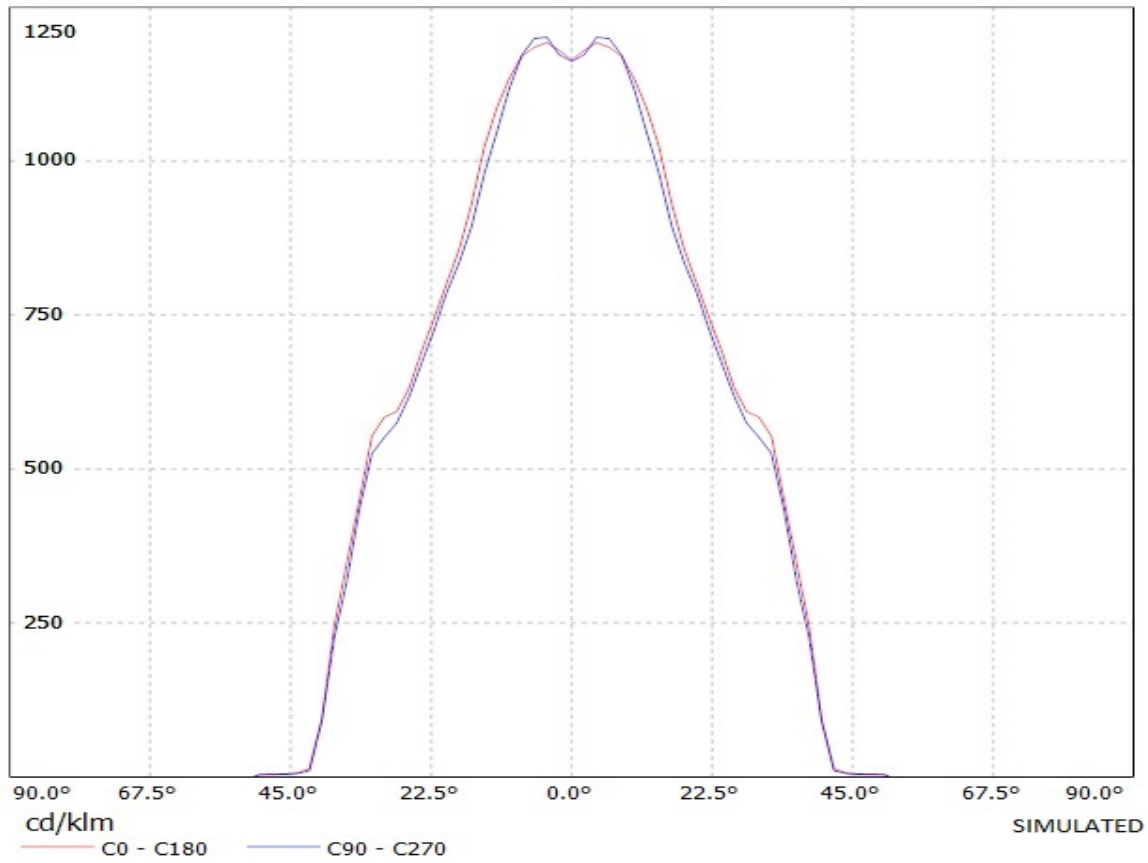

Ledil Oy CA10716_Boom-MC-S CA10716_Boom-MC-S / LDC (Polar

Luminaire: Ledil Oy CA10716_Boom-MC-S CA10716_Boom-MC-S

Lamps: 1 x Cree MC-E (white)

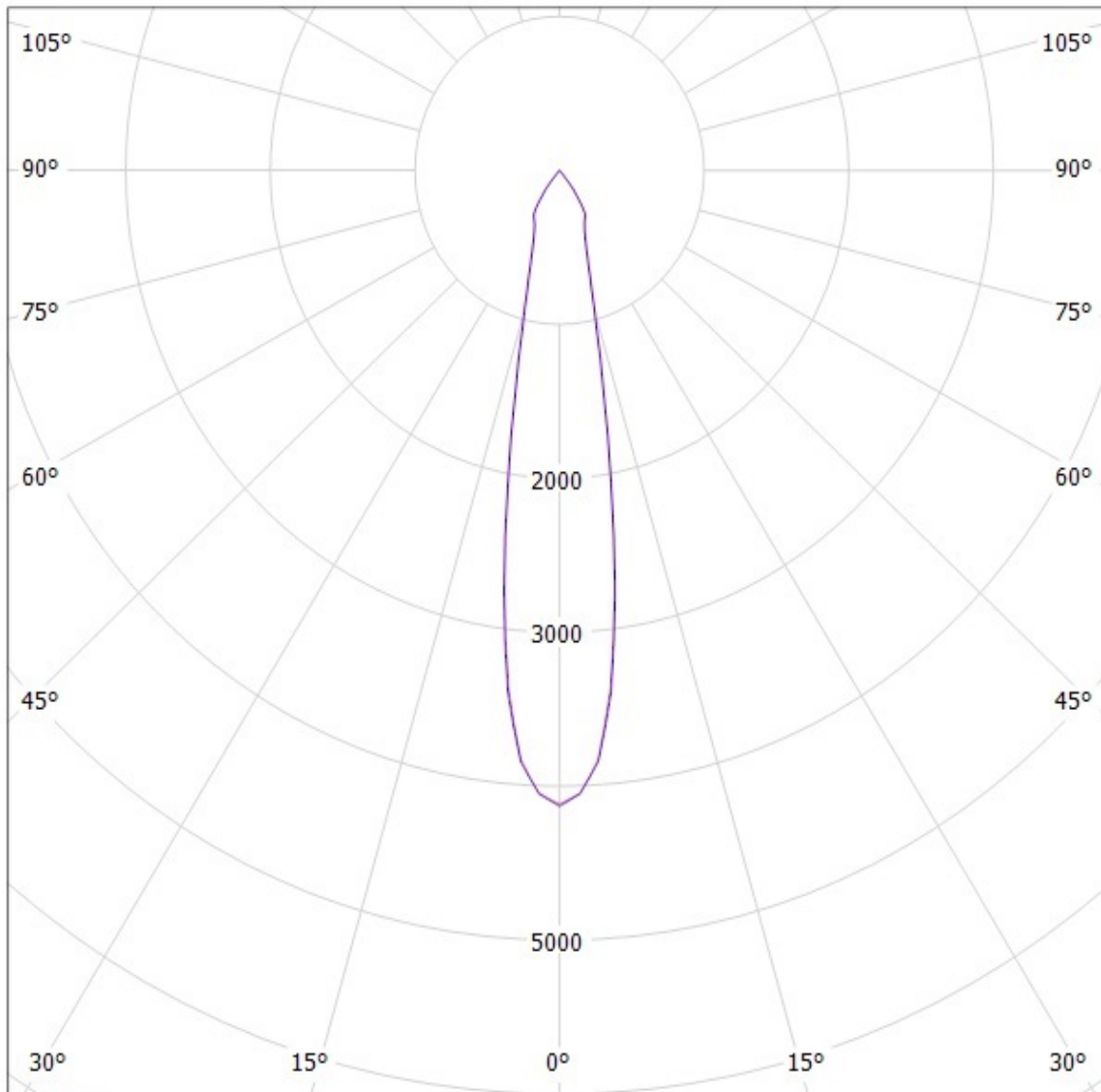

cd/klm

— C0 - C180 — C90 - C270

SIMULATED

Ledil Oy CA10928_Boom-MC-M CA10928_Boom-MC-M / LDC (Polar)

Luminaire: Ledil Oy CA10928_Boom-MC-M CA10928_Boom-MC-M

Lamps: 1 x Cree MC-E (white)

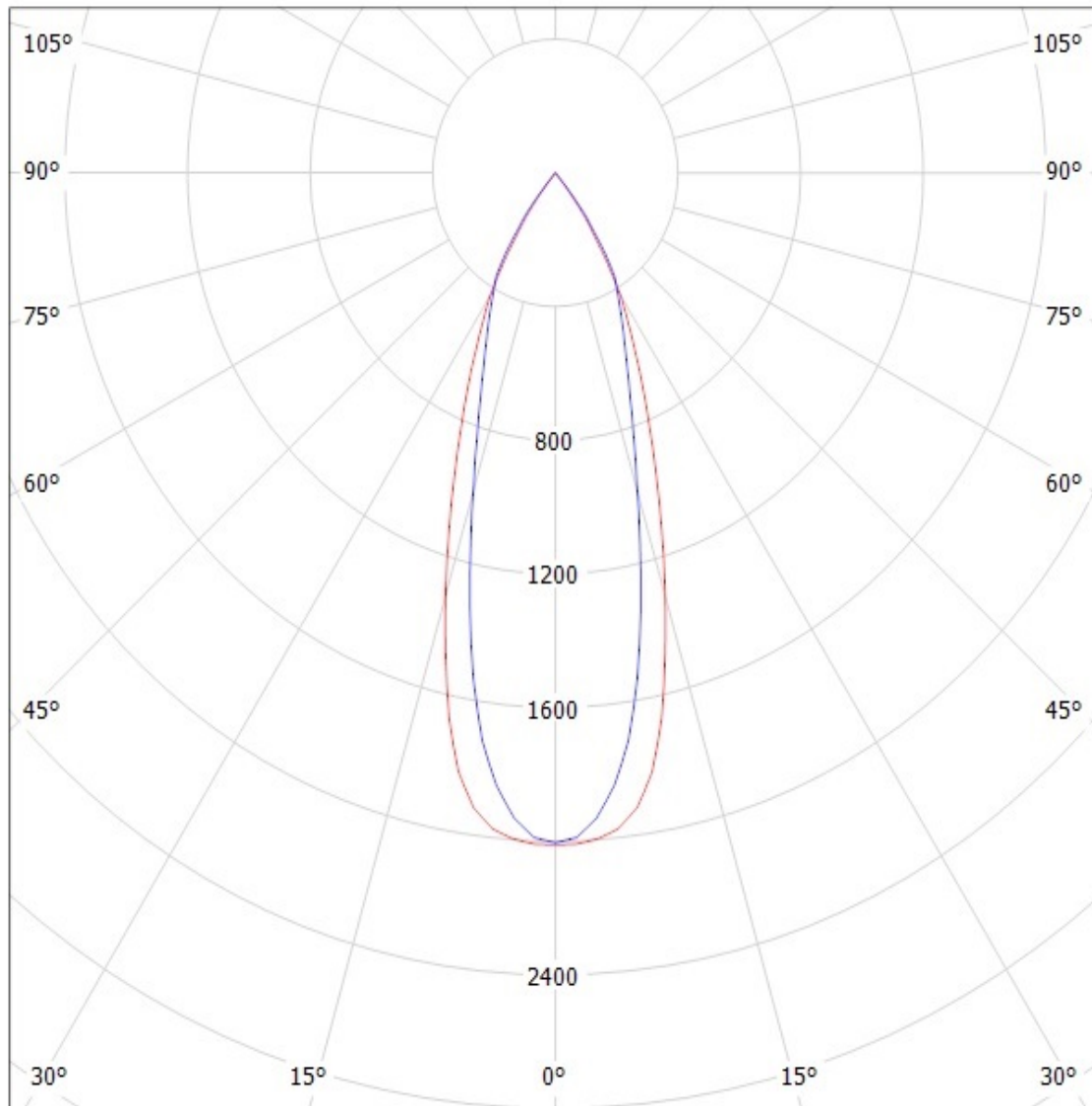

cd/klm

— C0 - C180 — C90 - C270

SIMULATED

Ledil Oy CA10929_Boom-MC-W CA10929_Boom-MC-W / LDC (Polar)

Luminaire: Ledil Oy CA10929_Boom-MC-W CA10929_Boom-MC-W
Lamps: 1 x Cree MC-E (white)

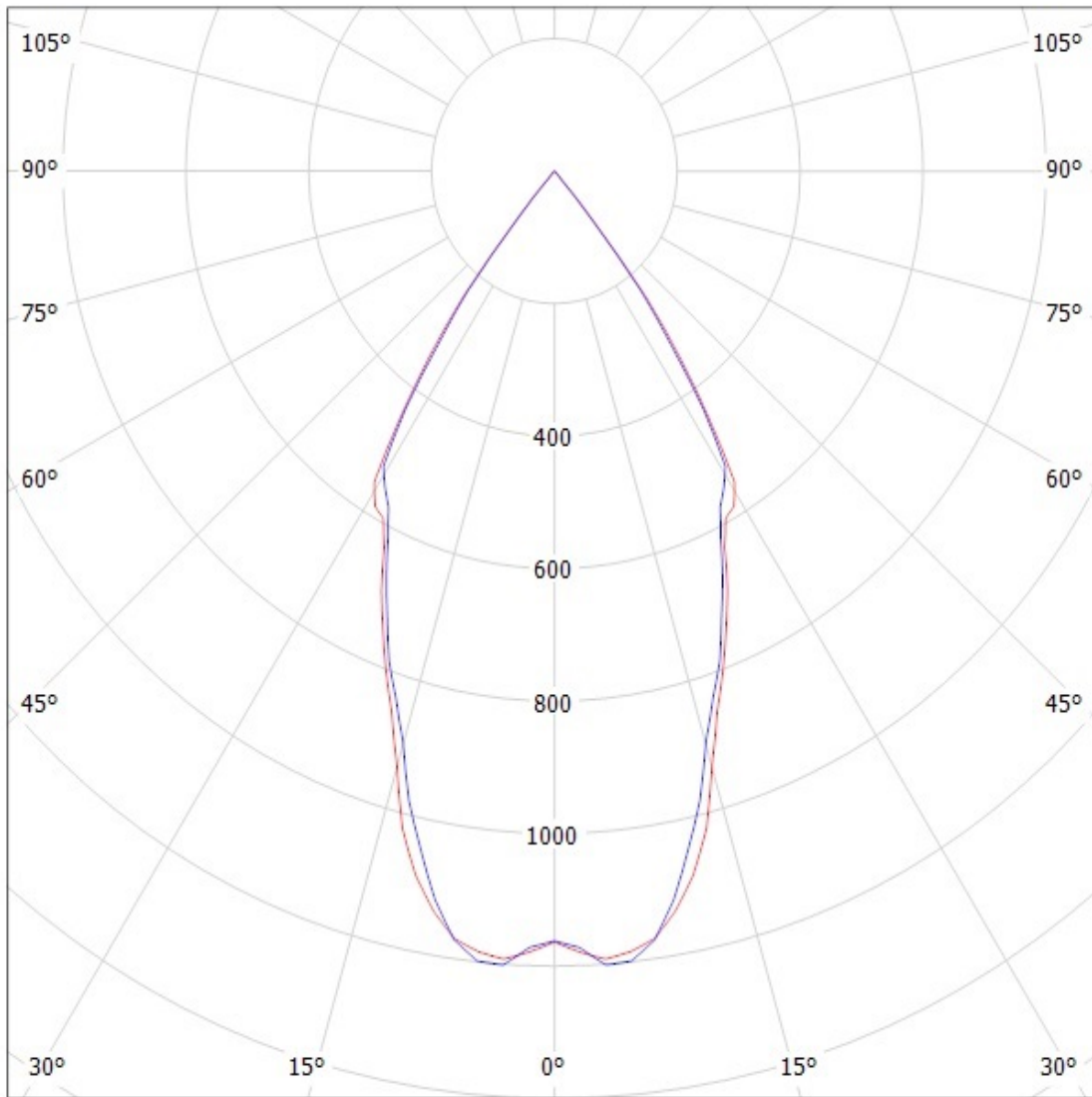

cd/klm

— C0 - C180 — C90 - C270

SIMULATED