

Surface Roughness/Contour Measuring System Formtracer SV-C3200/4500 Series

Bulletin No. 2073

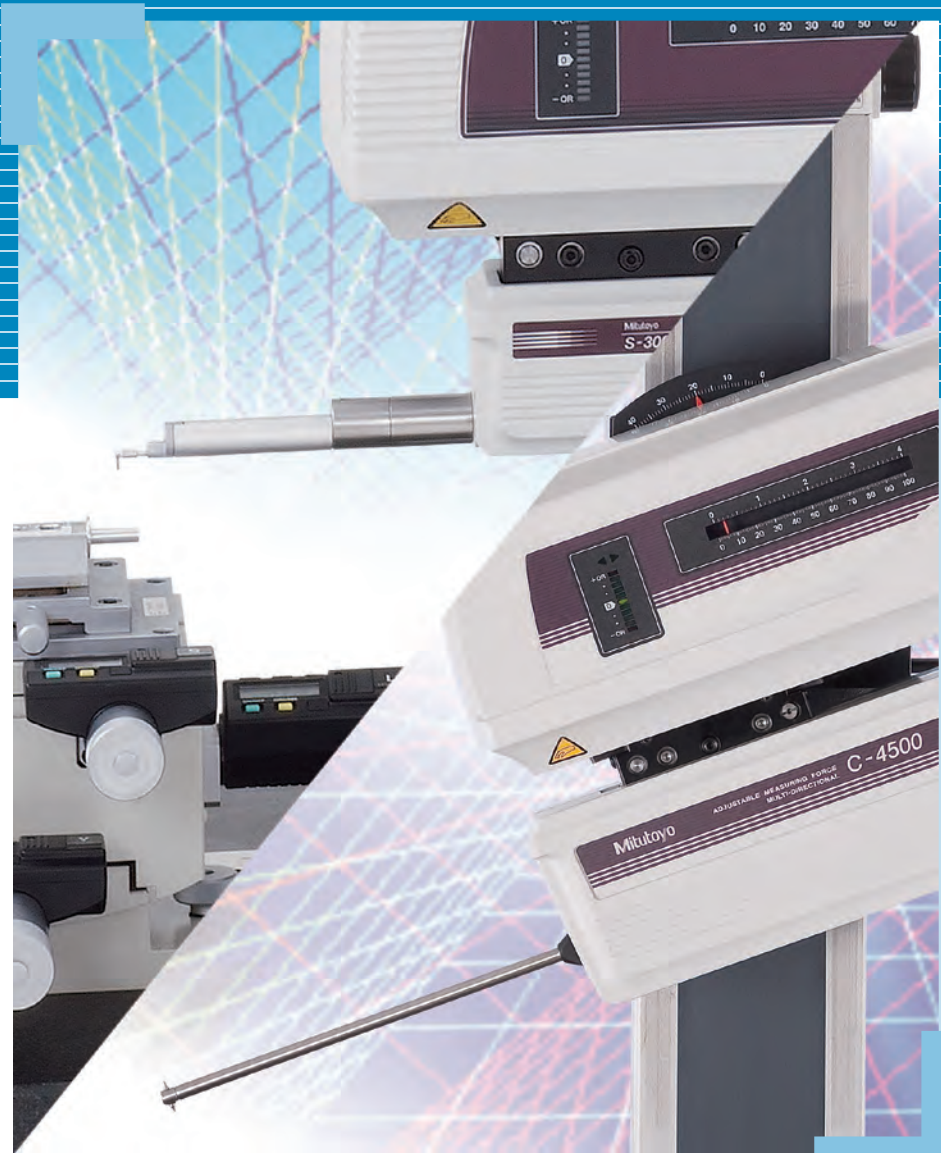

**Dual-purpose measurement and powerful analysis
of surface roughness and contour combined with
high accuracy, high drive speed and simplified
CNC measurement**

Mitutoyo

Hybrid measuring instrument for surface roughness and contour measurement

Contour Measuring Functions

Detector with new arm design

Expands measurement range while reducing workpiece interference
Mitutoyo's newly designed detector arm lowers workpiece interference while expanding the measurement range in the Z1 axis (detector).

- When using the SPH-71 one-sided cut stylus

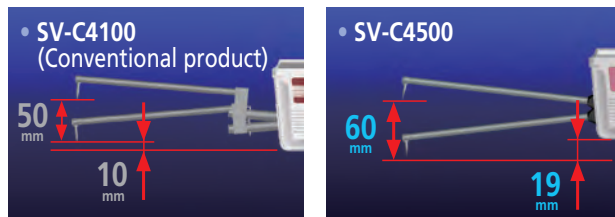

Detector measurement range expanded by 10 mm

One-touch arm attachment (Patent pending in Japan)

The arm mount uses a magnetic joint for quick and easy arm replacement. The mount also includes a safety mechanism.

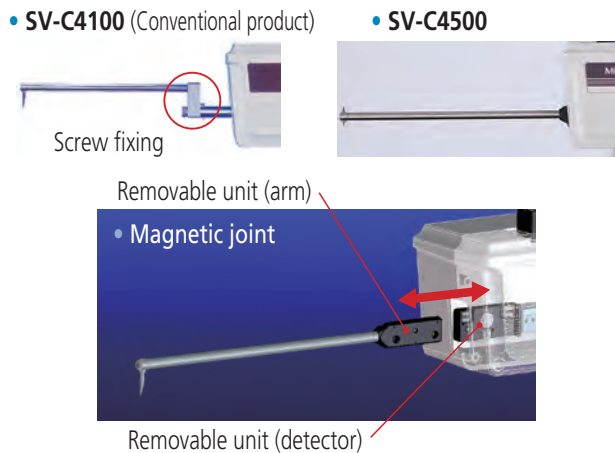

New function specified for 4500 Series

Continuous top-bottom measurement function

Upper and lower surfaces can be measured continuously by using Mitutoyo's double-sided conical stylus.

This continuous measurement data can be used to facilitate analysis of features that were difficult to measure before, such as the effective diameter of an internal screw-thread.

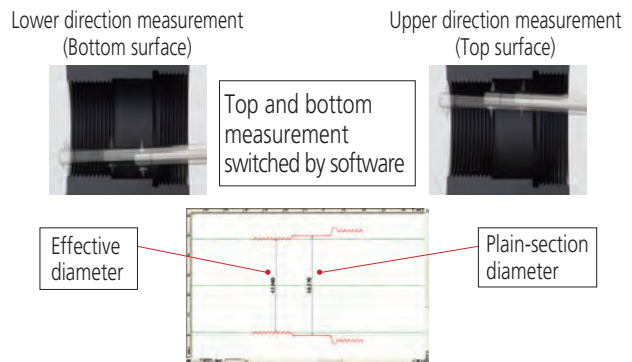

Continuous top-bottom measurement allows hassle-free one-step calibration

(Patent pending in Japan)

The one-step calibration kit supplied with the SV-C4500 Series has been upgraded to enable easy calibration of the double-ended conical stylus featuring a contact on both the top and the bottom. Precise work such as calibrating the Z1-axis gain, symmetry, and stylus radius can now be carried out in a single operation.



Variable measuring force function

The measuring force can be varied in 5 steps by using the software provided (**FORMTRACEPAK**), eliminating the need to adjust the measuring force by switching weights or through positional adjustment.

The SV-C4500 Series can also maintain the specified measuring force even when tilted.





SV-C4500S4



SV-C3200S4

Surface Roughness Measuring Functions

Supporting International Standards

Compliant with JIS '82/94/01, ISO, ANSI, DIN, VDA, and other international surface roughness standards.

We offer a product lineup of surface roughness detectors with different measuring forces

Standard detectors can be selected (as listed below) to conform to the international standard required.

0.75mN (tip angle 60°; tip radius 2µm)

4mN (tip angle 90°; tip radius 5µm)

Reduction of measuring time and operator's fatigue

In addition to high speed movement of main unit, reduction of setting time and operator's fatigue can be achieved by using Auto-leveling Table (option), which allows automatic leveling for a measuring face.

Common specifications

Fast traverse improves measurement efficiency

X axis (drive unit) : 80mm/s (MAX)
Z2 axis (column) : 30mm/s (MAX)

The total measurement time can be shortened by speeding up the traverse movements.

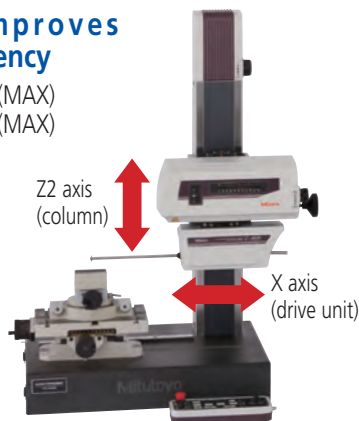

Remote-control unit enables safe, easy & fast measurement

The remote-control unit lets you move quickly from positioning to measurement. The unit also features an emergency stop switch and speed control knob for added safety while the machine is moving at high speeds.



Emergency stop switch

Drive speed control knob

New Remote Control Box

Auto stop feature assures safety even during high-speed movement

The detector includes a safety mechanism (auto stop upon collision) to assure measurement safety even during high-speed movement. If the arm is removed or shifts during measurement, the safety mechanism is triggered and stops the machine.

Direction of collision that may cause the safety device to be triggered

- Detector for contour measuring

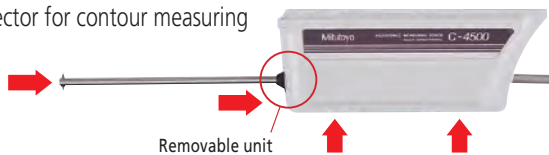

- Detector for surface roughness measuring

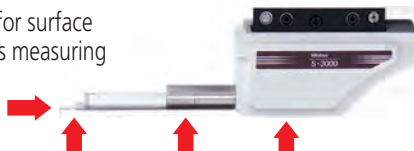

Incorporation of an ABS scale in the Z2 axis eliminates the need for wearisome origin point re-setting conventionally required for every step of repeated measurements over stepped or multiple sections.

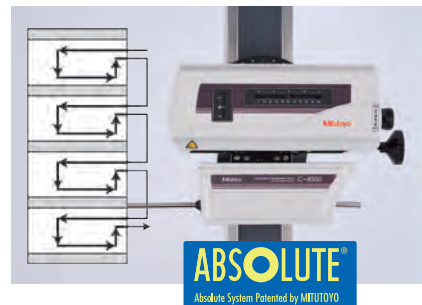

All detector and drive unit cables are housed inside the main unit to eliminate any risk of abrasion and guarantee trouble free, high-speed operation.



Integrated layout

You can use simple operations to lay out graphics obtained from measurements as well as measurement results for surface roughness, contour, and roundness on a single page. Furthermore, since the program now allows you to specify a saved file and paste it, you can easily paste results from multiple files.

Note: the optional ROUNDPAK roundness/cylindricity analysis program is required. (Ver. 7 or higher)

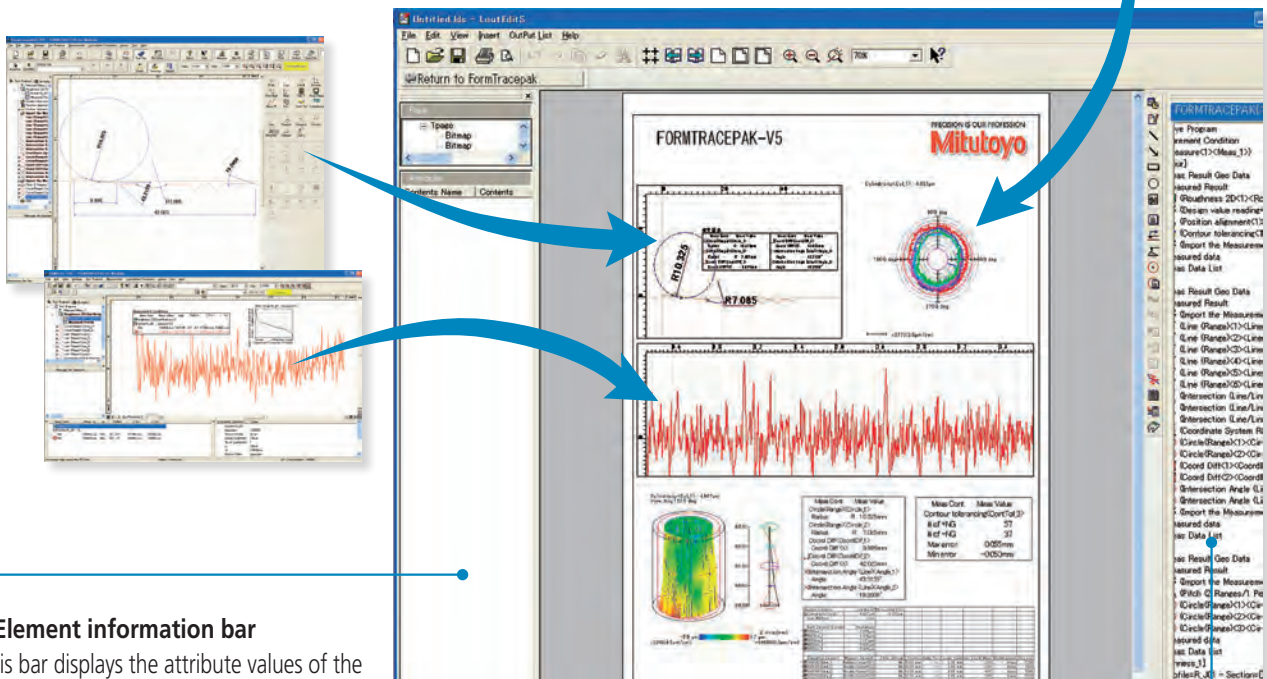
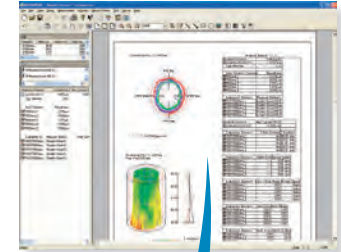

- **Element information bar**

This bar displays the attribute values of the pasted items, allowing you to easily check the contents of the pasted measurement data files.

- **System layout printing**

By simply selecting the items to be output, you can automatically lay out the page to be printed. Use this feature when you wish to simplify the printing task.

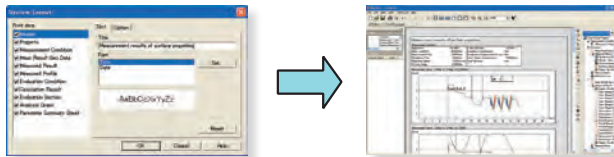

- **Report creation function**

You can freely assemble measurement results/conditions/graphics as well as comments/circles/lines/arrows, and print them out in a measurement result report. Furthermore, since you can paste bitmap files, you can also add a workpiece image or company logo to the layout. You can also save the created layout and use it again later for similar measurements.

- **Element insertion bar**

Using the mouse to drag and drop the analysis content displayed in the element insertion bar, you can paste it onto the layout. From the contour analysis result, you can also select the analysis result for a circle or line alone and paste it in position.

- **Saving the result as a web page**

Since you can save the result in html or mhtml format, which can be displayed using Internet Explorer or Microsoft Word, you can check the result even on a PC in which no layout-editing program is installed.

Optional Accessories for Automatic Measurement

Y-axis table: 178-097

Enables efficient, automatic measurement of multiple aligned workpieces and multiple points on a single measurement surface.

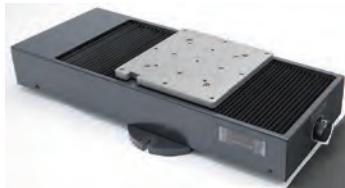

Travel range	200mm
Resolution	0.05µm
Positioning accuracy	±3µm
Drive speed	Max. 80mm/s
Maximum load	50kg
Mass	28kg



Rotary Table θ 1-axis table: 12AAD975*

For efficient measurement in the axial/transverse directions. When measuring a cylindrical workpiece, automatic alignment can be performed in combination with the Y-axis table.

* θ 1-axis mounting plate (12AAE630) is required when directly installing on the base of the SV-C3200/4500.

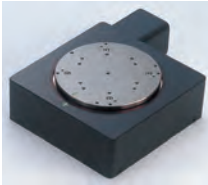

Displacement	360°
Resolution	0.004°
Maximum load	12kg
Rotational speed	Max. 10°/s
Mass	7kg



Rotary Table θ 2-axis unit: 178-078*

You can measure multiple points on a cylindrical workpiece and automate front/rear-side measurement.

* θ 2-axis mounting plate (12AAE718) is required when directly installing on the base of the SV-C3200/4500.



Displacement	360°
Resolution	0.0072°
Maximum load (loading moment)	4kg (343 N·cm or less)
Rotational speed	Max. 18°/s
Mass	5kg



Centering chuck (ring operated): 211-032

This chuck is useful when measuring small workpieces. You can easily clamp them with its knurled ring.



Clamping range	Jaws normal	OD: ϕ 1 - ϕ 36mm
	Jaws normal	ID: ϕ 16 - ϕ 69mm
	Jaws reversed	OD: ϕ 25 - ϕ 79mm
Dimensions	ϕ 118x41mm	
Mass	1.2kg	

Micro-chuck: 211-031

This chuck is suitable for clamping extra-small diameter workpieces (ϕ 1 mm or less), which cannot be retained with the centering chuck.



Clamping range	OD: ϕ 0.1 - ϕ 1.5mm
Dimensions	ϕ 118x48.5mm
Mass	0.6kg

Auto-leveling table: 178-087

This is a stage that performs fully automatic leveling as measurement starts, freeing the user from this troublesome operation. Fully automatic leveling can be done quickly by anyone. In addition, the operation is easy and reliable.



Inclination adjustment angle	±2°
Maximum load	7kg
Table dimensions	130x100mm
Mass	3.5kg

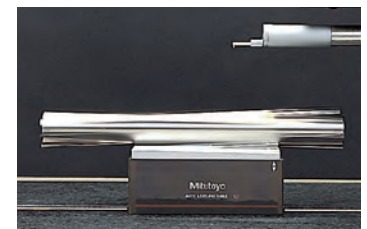

Options

3-axis Adjustment Table: 178-047

This table helps make the alignment adjustments required when measuring cylindrical surfaces. The corrections for the pitch angle and the swivel angle are determined from a preliminary measurement and the Digimatic micrometers are adjusted accordingly. A flat-surfaced work-piece can also be leveled with this table.

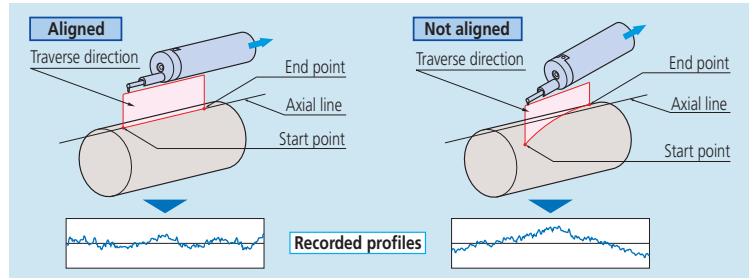
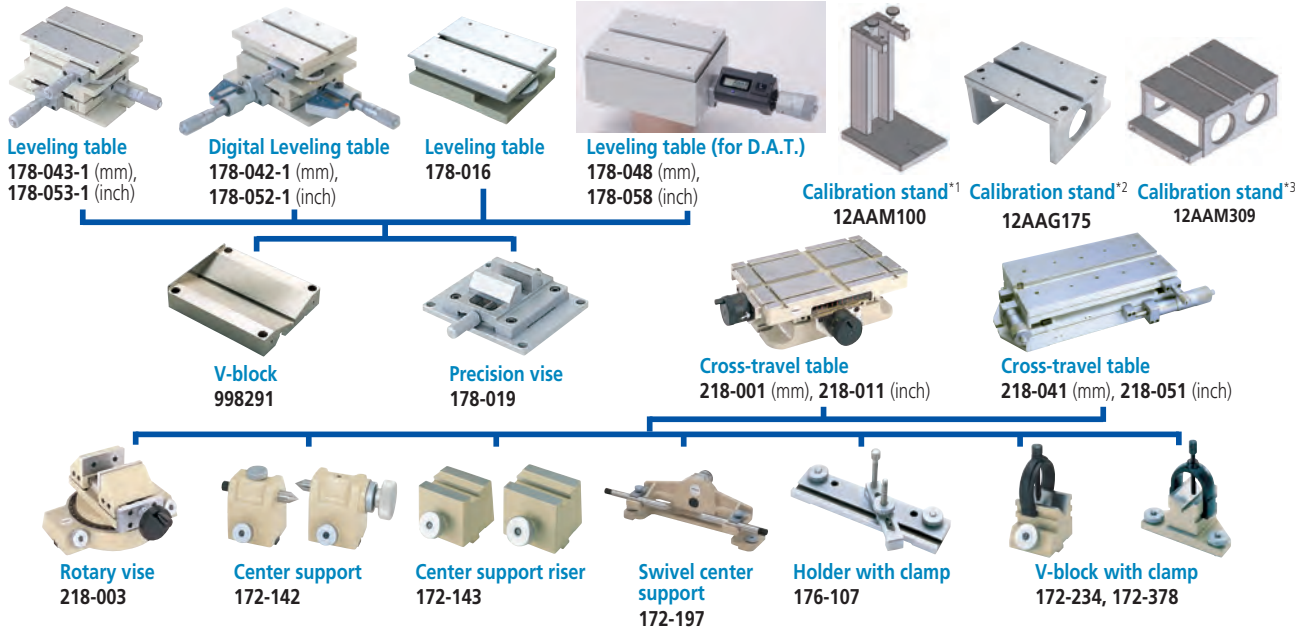

Table and fixture systems



• Desk type vibration isolators

Manually charged pneumatic type^{*4}



Automatically charged pneumatic type^{*4}
No.178-025

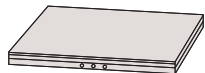

Stand for Desktop type
External size (WxDxH):640x470x660mm
Mass: 25kg

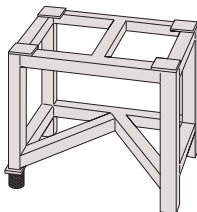

• Desk type vibration isolators

Desk type^{*4}
No.12AAK110

Monitor arm^{*5}
No.12AAK120

Side table^{*5}
No.12AAL019



Example combination: with side table but no monitor arm (tester and PC not included)

Example combination: with monitor arm but no side table^{*6} (tester and PC not included)

*1 Required for calibrating upward measurement of SV-C3200 series.

*2 Required for calibrating in bulk by mounting straight arm/small-hole stylus arm without using cross-travel table and Y-axis table.

*3 Required for calibrating in bulk by mounting straight arm/eccentric arm/small-hole stylus arm without using cross-travel table and Y-axis table.

*4 For models with a product code that ends in S4, S8, H4, or H8. Please contact us directly if you require units for models with a product code that ends in W4 or W8 (large base models).

*5 Used together with vibration isolator (No.12AAK110).

*6 User to provide a printer rack.

Detectors / Styli (For Surface Roughness Measuring)

Detectors

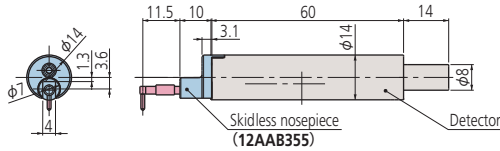

Order No.	Measuring force	
178-396-2	0.75mN	ISO-1997 and JIS-2001 compliant detectors
178-397-2	4mN	Detectors that comply with previous standards, for general use, etc.

Extension rods

- 12AAG202 Extension rod 50mm
- 12AAG203 Extension rod 100mm



* No more than one extension rod can be connected.

Styli

Standard stylus

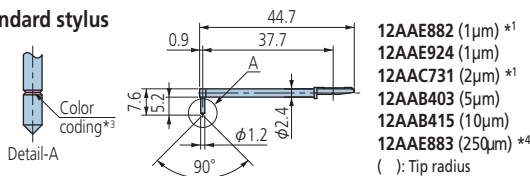

- 12AAE882 (1μm) *1
- 12AAE924 (1μm)
- 12AAC731 (2μm) *1
- 12AAB403 (5μm)
- 12AAB415 (10μm)
- 12AAE883 (250μm) *4
- (): Tip radius

Double-length for deep hole *2

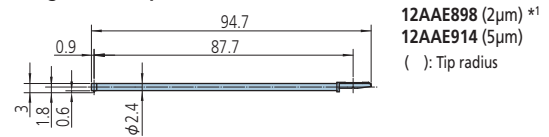

- 12AAE898 (2μm) *1
- 12AAE914 (5μm)
- (): Tip radius

For small hole

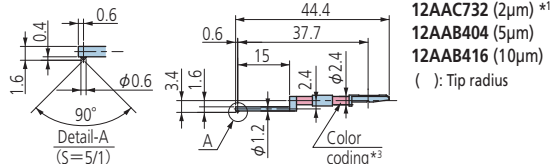

- 12AAC732 (2μm) *1
- 12AAB404 (5μm)
- 12AAB416 (10μm)
- (): Tip radius

For small hole/Double-length for deep hole *2

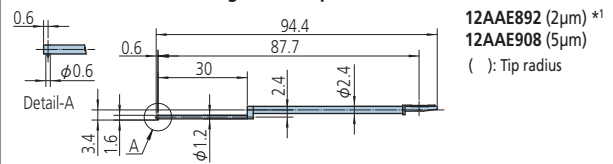

- 12AAE892 (2μm) *1
- 12AAE908 (5μm)
- (): Tip radius

For extra-small hole

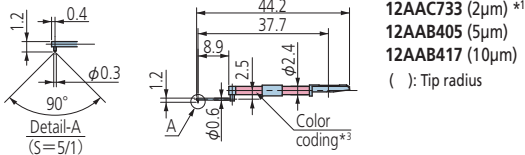

- 12AAC733 (2μm) *1
- 12AAB405 (5μm)
- 12AAB417 (10μm)
- (): Tip radius

For small hole *2 *4

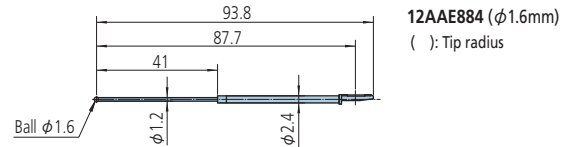

- 12AAE884 (φ1.6mm)
- (): Tip radius

For extra-minute hole

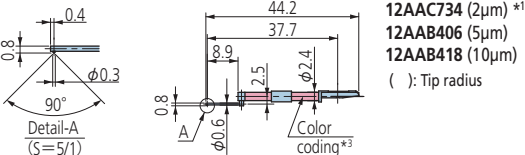

- 12AAC734 (2μm) *1
- 12AAB406 (5μm)
- 12AAB418 (10μm)
- (): Tip radius

For ultra-small hole *4

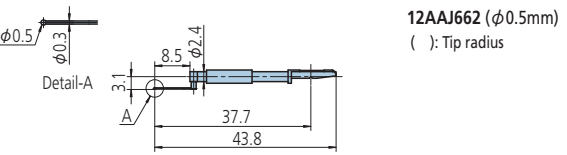

- 12AAJ662 (φ0.5mm)
- (): Tip radius

For deep hole (double-length and triple-length) *2

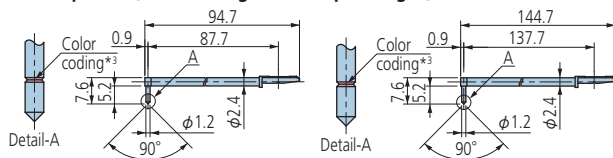

- 2X stylus
- 12AAC740 (2μm) *1
- 12AAB413 (5μm)
- 12AAB425 (10μm)
- (): Tip radius

- 3X stylus
- 12AAC741 (2μm) *1
- 12AAB414 (5μm)
- 12AAB426 (10μm)
- (): Tip radius

For small slotted hole *2

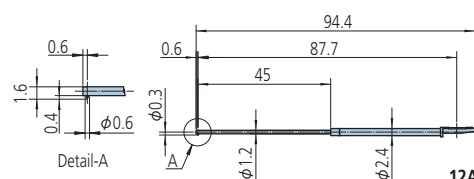

- 12AAE938 (2μm) *1
- 12AAE940 (5μm)
- (): Tip radius

*1: Tip angle 60°

*2: For downward-facing measurement only.

*3:

Tip radius	1μm	2μm	5μm	10μm	250μm
Color coding	White	Black	No color	Yellow	No notch or color

*4: Used for calibration, a standard step gauge (No.178-611 (mm), No.178-612 (inch), option) is also required

Styli

For deep groove (10mm)

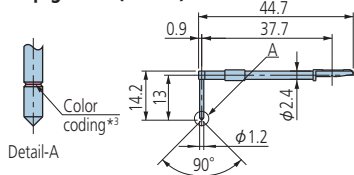

12AAC735 (2μm) *1
12AAB409 (5μm)
12AAB421 (10μm)
(): Tip radius

For deep groove *2 (20mm)

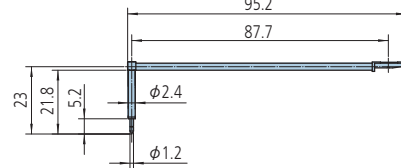

12AAE893 (2μm) *1
12AAE909 (5μm)
(): Tip radius

For deep groove *2 (20mm)

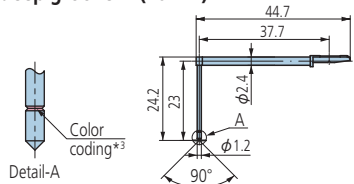

12AAC736 (2μm) *1
12AAB408 (5μm)
12AAB420 (10μm)
(): Tip radius

For deep groove *2 (40mm)

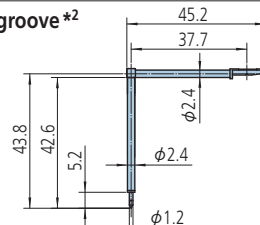

12AAE895 (2μm) *1
12AAE911 (5μm)
(): Tip radius

For deep groove *2 (30mm)

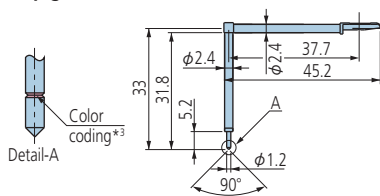

12AAC737 (2μm) *1
12AAB407 (5μm)
12AAB419 (10μm)
(): Tip radius

For deep groove (30mm)/Double-length for deep hole *2

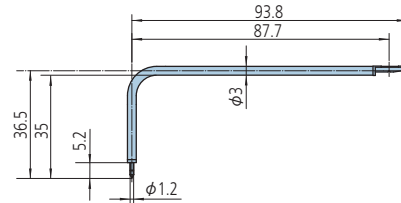

12AAE894 (2μm) *1
12AAE910 (5μm)
(): Tip radius

For gear tooth

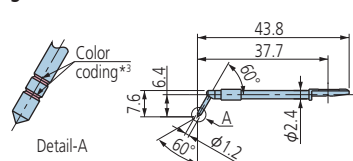

12AAB339 (2μm) *1
12AAB410 (5μm)
12AAB422 (10μm)
(): Tip radius

For gear tooth/Double-length for deep hole *2

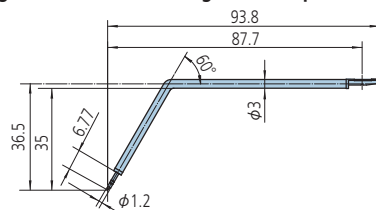

12AAE896 (2μm) *1
12AAE912 (5μm) *1
(): Tip radius

For rolling circle waviness surface *4

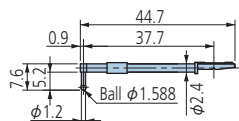

12AAB338 (φ1.588)
(): Tip radius

For rolling circle waviness/Double-length for deep hole *2 *4

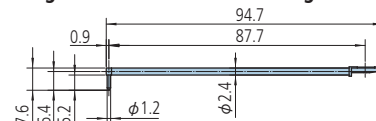

12AAE886 (250μm)
(): Tip radius

For knife-edge *4

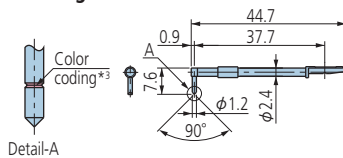

12AAC738 (2μm) *1
12AAB411 (5μm)
12AAB423 (10μm)
(): Tip radius

For corner hole/Double-length for deep hole *2

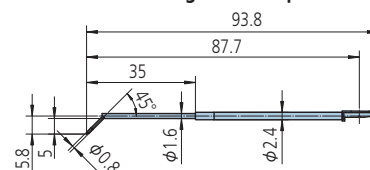

12AAE897 (2μm) *1
12AAE913 (5μm) *2
(): Tip radius

For eccentric arm *2

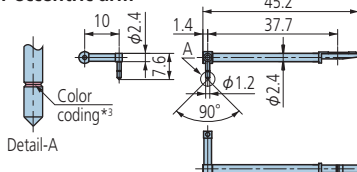

12AAC739 (2μm) *1
12AAB412 (5μm)
12AAB424 (10μm)
(): Tip radius

For bottom surface

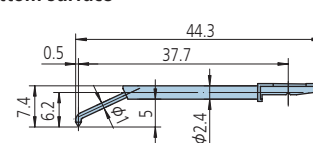

12AAE899 (2μm) *1
12AAE915 (5μm)
(): Tip radius

*1: Tip angle 60°

*2: For downward-facing measurement only.

Customized special interchangeable styli are available on request.
Please contact any Mitutoyo office for more information.

*3:

	2μm	5μm	10μm
Tip radius			
Color coding	Black	No color	Yellow

*4: Used for calibration, a standard step gauge (No.178-611 (mm), No.178-612 (mm), option) is also required

Arms / Styli (For Contour Measuring)

Arms

Description	Arm No.	Parts No.	Applicable stylus No.
Straight arm	AB-31*1	12AAM101	SPH-5*, 6*, 7*, 8*, 9*, SPHW*2-56,66,76
Eccentric arm	AB-32	12AAM102	SPH-5*, 6*, 7*, 8*, 9*, SPHW*2-56,66,76
Small-hole arm	AB-33	12AAM103	SPH-41, 42, 43

*1 Standard accessory

*2 Stylus for SV-C4500 series

*3 One-sided cut stylus SPH-71 (standard accessory) mounting

•Straight arm AB-31

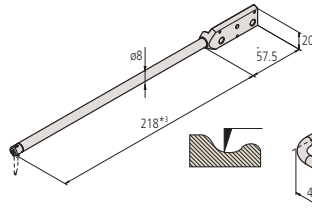

•Eccentric arm AB-32

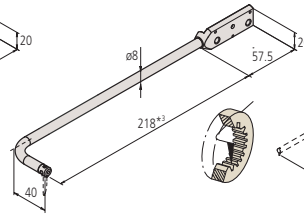

•Small-hole arm AB-33

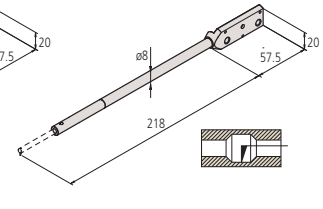

Styli

Stylus name	Stylus No.	Parts No.	Application arm No.	H (mm)
Double-sided conical stylus *1	SPHW-56	12AAM095*2	AB-31, AB-32	20
	SPHW-66	12AAM096	AB-31, AB-32	32
	SPHW-76	12AAM097	AB-31, AB-32	48
One-sided cut stylus	SPH-51	354882	AB-31, AB-32	6
	SPH-61	354883	AB-31, AB-32	12
	SPH-71	354884 *2*3	AB-31, AB-32	20
	SPH-81	354885	AB-31, AB-32	30
	SPH-91	354886	AB-31, AB-32	42
Intersecting cut stylus	SPH-52	354887	AB-31, AB-32	6
	SPH-62	354888	AB-31, AB-32	12
	SPH-72	354889	AB-31, AB-32	20
	SPH-82	354890	AB-31, AB-32	30
	SPH-92	354891	AB-31, AB-32	42
Cone stylus Tip angle 30° Sapphire tipped	SPH-53	354892	AB-31, AB-32	6
	SPH-63	354893	AB-31, AB-32	12
	SPH-73	354894	AB-31, AB-32	20
	SPH-83	354895	AB-31, AB-32	30
	SPH-93	354896	AB-31, AB-32	42
Cone stylus Tip angle 30° Carbide-tipped	SPH-56	12AAA566	AB-31, AB-32	6
	SPH-66	12AAA567	AB-31, AB-32	12
	SPH-76	12AAA568	AB-31, AB-32	20
	SPH-86	12AAA569	AB-31, AB-32	30
	SPH-96	12AAA570	AB-31, AB-32	42
Cone stylus Tip angle 20° Carbide-tipped	SPH-57	12AAE865	AB-31, AB-32	6
	SPH-67	12AAE866	AB-31, AB-32	12
	SPH-77	12AAE867	AB-31, AB-32	20
	SPH-87	12AAE868	AB-31, AB-32	30
	SPH-97	12AAE869	AB-31, AB-32	42
Cone stylus Tip angle 50° Diamond tipped	SPH-79	355129	AB-31, AB-32	20
Knife edge stylus	SPH-54	354897	AB-31, AB-32	6
	SPH-64	354898	AB-31, AB-32	12
	SPH-74	354899	AB-31, AB-32	20
	SPH-84	354900	AB-31, AB-32	30
Ball stylus	SPH-94	354901	AB-31, AB-32	42
	SPH-55	354902	AB-31, AB-32	6
	SPH-65	354903	AB-31, AB-32	12
	SPH-75	354904	AB-31, AB-32	20
	SPH-85	354905	AB-31, AB-32	30
Small hole stylus*4	SPH-95	354906	AB-31, AB-32	42
	SPH-41	12AAM104	AB-33	2
	SPH-42	12AAM105	AB-33	4
	SPH-43	12AAM106	AB-33	6.5

*1 Stylus for SV-C4500 series

*2 Standard accessory of SV-C4500 series

*3 Standard accessory of SV-C3200 series

*4 Styli SPH-21, 22, and 23 for SV-C3100/4100 series are not available.

Double-sided conical stylus

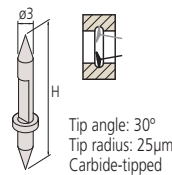

Tip angle: 30°
Tip radius: 25µm
Carbide-tipped

Cone stylus

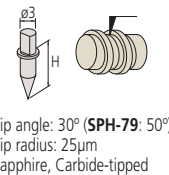

Tip angle: 30° (SPH-79: 50°)
Tip radius: 25µm
Sapphire, Carbide-tipped
(SPH-79: Diamond tipped)

Small hole stylus SPH-41

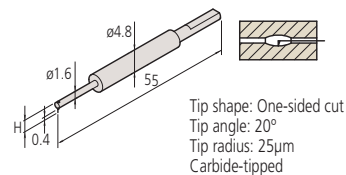

Tip shape: One-sided cut
Tip angle: 20°
Tip radius: 25µm
Carbide-tipped

One-sided cut stylus

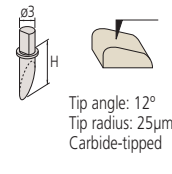

Tip angle: 12°
Tip radius: 25µm
Carbide-tipped

Cone stylus

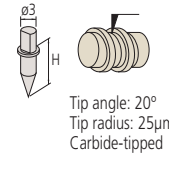

Tip angle: 20°
Tip radius: 25µm
Carbide-tipped

Small hole stylus SPH-42

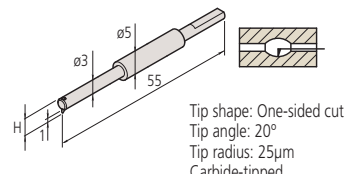

Tip shape: One-sided cut
Tip angle: 20°
Tip radius: 25µm
Carbide-tipped

Intersecting cut stylus

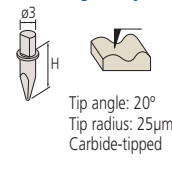

Tip angle: 20°
Tip radius: 25µm
Carbide-tipped

Knife edge stylus

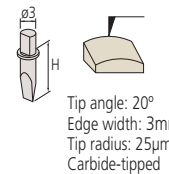

Tip angle: 20°
Edge width: 3mm
Tip radius: 25µm
Carbide-tipped

Small hole stylus SPH-43

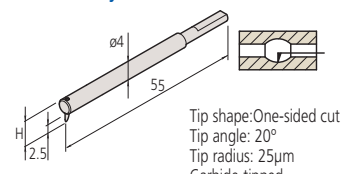

Tip shape: One-sided cut
Tip angle: 20°
Tip radius: 25µm
Carbide-tipped

Ball stylus

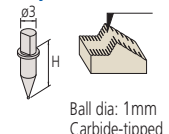

Ball dia: 1mm
Carbide-tipped

Arm stylus (comprising an arm and stylus)

Arm stylus name	Stylus No.	Parts No.	H (mm)
Double-sided small hole arm stylus	SPHW-31	12AAM108	2.4
	SPHW-32	12AAM109	5
	SPHW-33	12AAM110	9

*5 Arm Stylus for SV-C4500 series

Double-sided small hole arm stylus SPHW-31

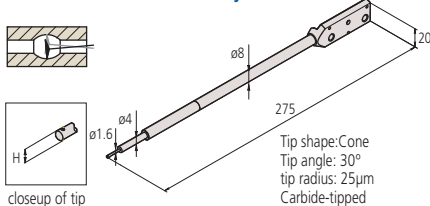

closeup of tip

Tip shape: Cone
Tip angle: 30°
tip radius: 25µm
Carbide-tipped

Double-sided small hole arm stylus SPHW-32

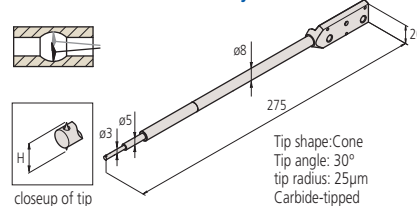

closeup of tip

Tip shape: Cone
Tip angle: 30°
tip radius: 25µm
Carbide-tipped

Double-sided small hole arm stylus SPHW-33

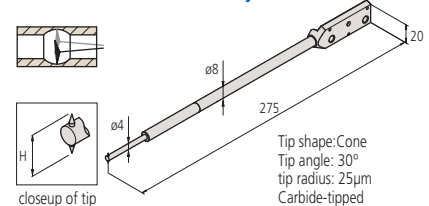

closeup of tip

Tip shape: Cone
Tip angle: 30°
tip radius: 25µm
Carbide-tipped

Dimensions

X-axis (drive unit) measuring range : 100mm TYPE (S4/H4/W4)

Unit: mm

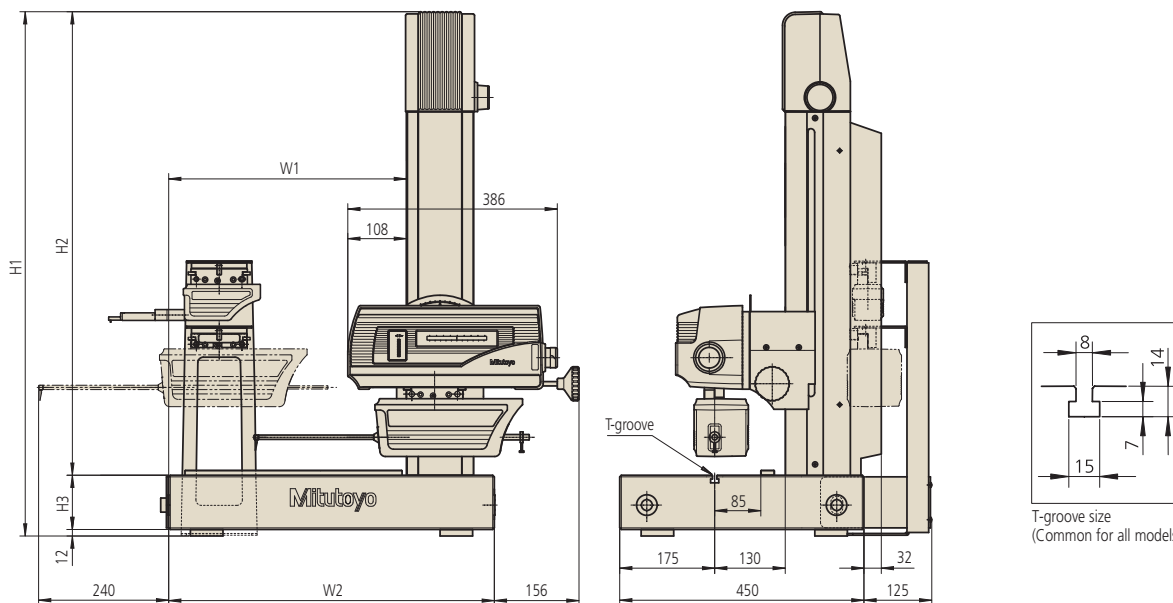

X-axis (drive unit) measuring range : 200mm TYPE (S8/H8/W8)

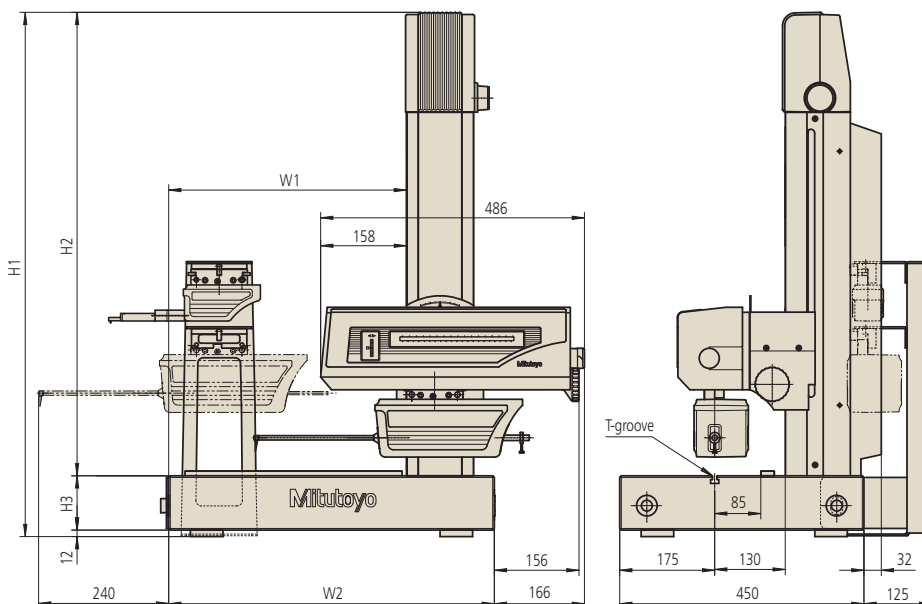

X-axis (drive unit) Measuring range	Models		H1 (mm)	H2 (mm)	H3 (mm)	W1 (mm)	W2 (mm)
	3200 Series	4500 Series					
100mm	SV-C3200S4	SV-C4500S4	966	854	100	438	600
	SV-C3200H4	SV-C4500H4	1166	1054	100	438	600
	SV-C3200W4	SV-C4500W4	1176	1054	110	838	1000
200mm	SV-C3200S8	SV-C4500S8	966	854	100	438	600
	SV-C3200H8	SV-C4500H8	1166	1054	100	438	600
	SV-C3200W8	SV-C4500W8	1176	1054	110	838	1000

Specifications

Model No. (Order No.)	SV-C3200S4 (525-491A-1)	SV-C3200H4 (525-492A-1)	SV-C3200W4 (525-493A-1)	SV-C3200S8 (525-496A-1)	SV-C3200H8 (525-497A-1)	SV-C3200W4 (525-498A-1)
	SV-C4500S4 (525-451A-1)	SV-C4500H4 (525-452A-1)	SV-C4500W4 (525-453A-1)	SV-C4500S8 (525-456A-1)	SV-C4500H8 (525-457A-1)	SV-C4500W8 (525-458A-1)

Specifications for Surface Roughness Measurement

Measuring range	X axis (drive unit)	100mm	200mm
	Z1 axis (detector unit)	800 μ m / 80 μ m / 8 μ m	
Straightness		(0.05+0.001L) μ m L = Drive length (mm)	0.5 μ m / 200mm
Resolution	Z1 axis (detector unit)	0.01 μ m (800 μ m) , 0.001 μ m (80 μ m) , 0.0001 μ m (8 μ m)	
Measuring force		0.75mN or 4mN	
Stylus tip		60°, 2 μ mR (Measuring force: 0.75mN) or 90°, 5 μ mR (Measuring force: 4mN)	
Conformable standards		JIS1982/JIS1994/JIS2001/ISO1997/ANSI/VDA	
Parameters		Pa, Pq, Psk, Pku, Pp, Pv, Pz, Pt, Pc, PSm, P Δ q, Pm (rC) Pmr, P δ c, Ra, Rq, Rsk, Rku, Rp, Rv, Rz, Rt, Rc, RSm, R Δ q, Rm (rC) Rmr, R c, Wa, Wq, Wsk, Wku, Wp, Wv, Wz, Wt, Wc, WSm, W Δ q, Wm (rC) Wmr, W δ c, Rk, Rpk, Rvk, Mr1, Mr2, A1, A2, Rx, AR, R, Wx, AW, W, Wte, Ry, RyDIN, RzDIN, R3y, R3z, S, HSC, Lo, Ir, Δ a, λ a, λ q, Vo, Htp, NR, NCRX, CPM, SR, SAR, NW, SW, SAW	
Assessed profiles		Primary Profile, Roughness profile, Envelope residual curve, Filtered waviness curve, Band pass waviness curve, Waviness curve, Rolling circle waviness curve, Roughness motif, Waviness motif, DIN4776 curve	
Graphs		Amplitude distribution graphs, BAC1, BAC2, Power spectrum curve, Auto correlation curve Inclination angle distribution curve, Peak point height distribution curve, Parameter distribution curve	
Data compensation		Tilt compensation, R-surface compensation, Ellipse Compensation, Parabola compensation, Hyperbolic compensation, Polynomial compensation, Conic automatic compensation, Polynomial automatic compensation	
Filters		Gaussian filter, 2CRPC75, 2CRPC50, 2CR75, 2CR50, Robust spline filter	

Specifications for Contour Measurement

Measuring range	X axis (drive unit)	100mm	200mm
	Z1 axis (detector unit)	60mm (\pm 30mm in horizontal situation)	
Straightness (when the X axis is horizontal)		0.8 μ m / 100mm	2 μ m / 200mm
Accuracy	X axis (drive unit)	\pm (0.8+0.01L) μ m L = Drive length (mm)	\pm (0.8+0.02L) μ m L = Drive length (mm)
	Z1 axis (detector unit)	SV-C3200 series: \pm (1.6+2H /100) μ m, SV-C4500 series: \pm (0.8+2H /100) μ m H = Measurement height from the horizontal position (mm)	
Resolution	X axis (drive unit)	0.05 μ m	
	Z1 axis (detector unit)	SV-C3200 series: 0.04 μ m, SV-C4500 series: 0.02 μ m	
	Z2 axis (column)	1 μ m	
Measuring force		SV-C3200 series: 30mN, SV-C4500 series:10, 20, 30, 40, 50mN (Setting measuring force FORMTRACEPAK)	
Measuring face direction		SV-C3200 series: Both upward and downward, SV-C4500 series: Both upward and downward (direction switch from FORMTRACEPAK)	

Common Specifications

Z2-axis (column) travel range	300mm	500mm	300mm	500mm
X-axis inclination angle	\pm 45°			
Drive speed	X axis 0~80mm/s and manual operation			
	Z2 axis (column) 0~30mm/s and manual operation			
Measuring speed	0.02-5mm/s			

Note: All information regarding our products, and in particular the illustrations, drawings, dimensional and performance data contained in this printed matter as well as other technical data are to be regarded as approximate average values. We therefore reserve the right to make changes to the corresponding designs. The stated standards, similar technical regulations, descriptions and illustrations of the products were valid at the time of printing. In addition, the latest applicable version of our General Trading Conditions will apply. Only quotations submitted by ourselves may be regarded as definitive.

Mitutoyo products are subject to US Export Administration Regulations (EAR). Re-export or relocation of our products may require prior approval by an appropriate governing authority.

Trademarks and Registrations

Designations used by companies to distinguish their products are often claimed as trademarks. In all instances where Mitutoyo America Corporation is aware of a claim, the product names appear in initial capital or all capital letters. The appropriate companies should be contacted for more complete trademark and registration information.

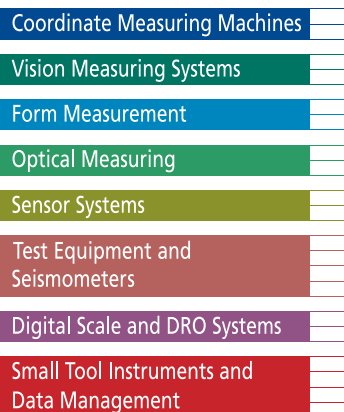

Mitutoyo America Corporation

www.mitutoyo.com

One Number to Serve You Better
1-888-MITUTOYO (1-888-648-8869)

M³ Solution Centers

Aurora, Illinois
(Corporate Headquarters)

Westford, Massachusetts
Huntersville, North Carolina

Mason, Ohio

Plymouth, Michigan

City of Industry, California
Birmingham, Alabama

Mitutoyo
Precision is our Profession