

SPEC. No. ED-04P089  
ISSUE May 13, 2004

# SHARP

OPTO-ELECTRONIC DEVICES DIVISION  
ELECTRONIC COMPONENTS GROUP  
SHARP CORPORATION

## SPECIFICATION

DEVICE SPECIFICATION FOR

PHOTOCOUPLER

MODEL No.

PC357

(Business dealing name : PC357N14J00F)

Specified for \_\_\_\_\_

Enclosed please find copies of the Specifications which consists of 11 pages including cover.  
After confirmation of the contents, please be sure to send back  copies of the Specifications  
with approving signature on each.

CUSTOMER'S APPROVAL

DATE \_\_\_\_\_

BY \_\_\_\_\_

PRESENTED

DATE \_\_\_\_\_

BY H. Imanaka

H. Imanaka,  
Department General Manager of  
Engineering Dept.,II  
Opto-Electronic Devices Div.  
ELECOM Group  
SHARP CORPORATION

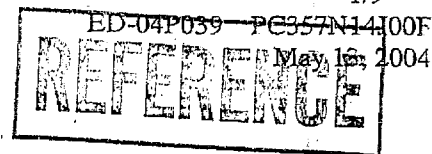

Product name : PHOTOCOUPLER

Model No. : PC357

(Business dealing name : PC357N14J00F)

1. These specification sheets include materials protected under copyright of Sharp Corporation ("Sharp"). Please do not reproduce or cause anyone to reproduce them without Sharp's consent.
2. When using this product, please observe the absolute maximum ratings and the instructions for use outlined in these specification sheets, as well as the precautions mentioned below. Sharp assumes no responsibility for any damage resulting from use of the product which does not comply with the absolute maximum ratings and the instructions included in these specification sheets, and the precautions mentioned below.

(Precautions)

- (1) This product is designed for use in the following application areas ;

( · OA equipment    Audio visual equipment    · Home appliances  
 · Telecommunication equipment (Terminal)    · Measuring equipment  
 · Tooling machines    · Computers

If the use of the product in the above application areas is for equipment listed in paragraphs (2) or (3), please be sure to observe the precautions given in those respective paragraphs.

- (2) Appropriate measures, such as fail-safe design and redundant design considering the safety design of the overall system and equipment, should be taken to ensure reliability and safety when this product is used for equipment which demands high reliability and safety in function and precision, such as ;

( · Transportation control and safety equipment (aircraft, train, automobile etc.)  
 · Traffic signals    · Gas leakage sensor breakers    · Rescue and security equipment  
 · Other safety equipment

- (3) Please do not use this product for equipment which require extremely high reliability and safety in function and precision, such as ;

( · Space equipment    · Telecommunication equipment (for trunk lines)  
 · Nuclear power control equipment    · Medical equipment

- (4) Please contact and consult with a Sharp sales representative if there are any questions regarding interpretation of the above three paragraphs.

3. Please contact and consult with a Sharp sales representative for any questions about this product.

1. Application

This specification applies to the outline and characteristics of photocoupler Model No. PC357(Lead free type).

2. Outline

Refer to the attached sheet, page 3.

3. Ratings and characteristics

Refer to the attached sheet, page 4, 5.

4. Reliability

Refer to the attached sheet, page 6.

5. Outgoing inspection

Refer to the attached sheet, page 7.

6. Supplement

6.1 Isolation voltage shall be measured in the following method.

- (1) Short between anode and cathode on the primary side and between collector and emitter on the secondary side.
- (2) The dielectric withstand tester with zero-cross circuit shall be used.
- (3) The wave form of applied voltage shall be a sine wave.

6.2 Packaging specifications

Refer to the attached sheet, page 8, 9.

6.3 The business dealing name used for this product when ordered or delivered shall be PC357N14J00F

6.4 This Model is approved by UL.

Approved Model No. : PC357

UL file No. : E64380

6.5 This product is not designed against irradiation.

This product is assembled with electrical input and output.

This product incorporates non-coherent light emitting diode.

6.6 ODS materials

This product shall not contain the following materials.

Also, the following materials shall not be used in the production process for this product.

Materials for ODS : CFC<sub>s</sub>, Halon, Carbon tetrachloride, 1,1,1-Trichloroethane (Methyl chloroform)

6.7 Brominated flame retardants

Specific brominated flame retardants such as the PBBO<sub>s</sub> and PBB<sub>s</sub> are not used in this device component at all.

7. Notes

Precautions for photocouplers : Attachment-1

2. Outline

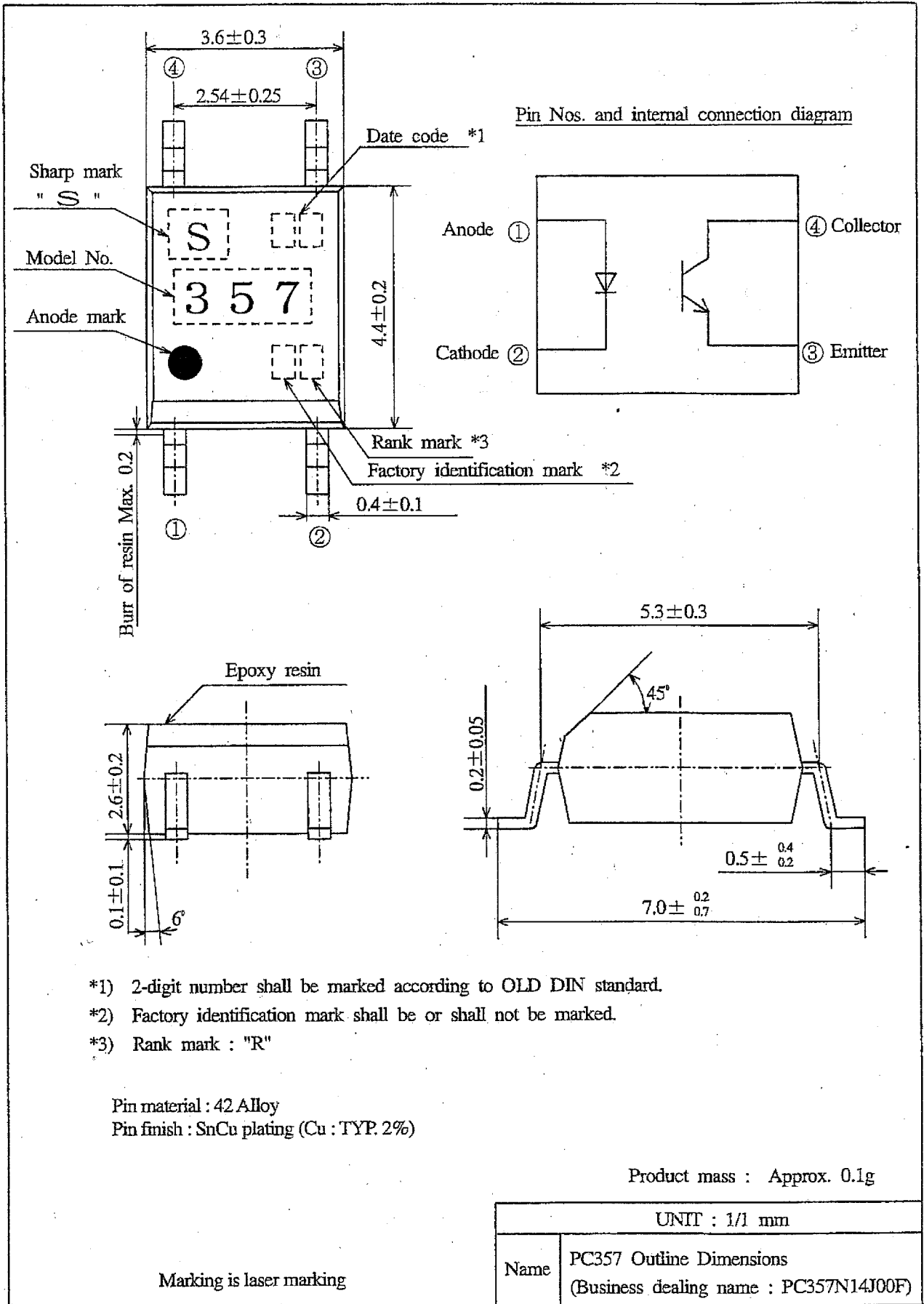

### 3. Ratings and characteristics

#### 3.1 Absolute maximum ratings

Ta=25°C

Parameter		Symbol	Rating	Unit
Input	*1 Forward current	$I_F$	50	mA
	*2 Peak forward current	$I_{FM}$	1	A
	Reverse voltage	$V_R$	6	V
	*1 Power dissipation	$P$	70	mW
Output	Collector-emitter voltage	$V_{CEO}$	80	V
	Emitter-collector voltage	$V_{ECO}$	6	V
	Collector current	$I_c$	50	mA
	*1 Collector power dissipation	$P_c$	150	mW
*1 Total power dissipation		$P_{tot}$	170	mW
Operating temperature		$T_{opr}$	-30 to +100	°C
Storage temperature		$T_{stg}$	-40 to +125	°C
*3 Isolation voltage		$V_{iso(ms)}$	3.75	kV
*4 Soldering temperature		$T_{sol}$	260	°C

\*1 The derating factors of absolute maximum ratings due to ambient temperature are shown in Fig. 1 to 4.

\*2 Pulse width  $\leq 100 \mu s$ , Duty ratio : 0.001 (Refer to Fig. 5)

\*3 AC for 1 min, 40 to 60%RH,  $f=60Hz$

\*4 For 10 s

#### 3.2 Electro-optical characteristics

Ta=25°C

Parameter		Symbol	Conditions	MIN.	TYP.	MAX.	Unit
Input	Forward voltage	$V_F$	$I_F=20mA$	-	1.2	1.4	V
	Reverse current	$I_R$	$V_R=4V$	-	-	10	$\mu A$
	Terminal capacitance	$C_t$	$V=0, f=1kHz$	-	30	250	pF
Output	Dark current	$I_{CEO}$	$V_{CE}=50V, I_F=0$	-	-	100	nA
	Collector-emitter breakdown voltage	$BV_{CEO}$	$I_c=0.1mA, I_F=0$	80	-	-	V
	Emitter-collector breakdown voltage	$BV_{ECO}$	$I_E=10 \mu A, I_F=0$	6	-	-	V
Transfer characteristics	Collector current	$I_c$	$I_F=1mA, V_{CE}=5V$	1	-	4	mA
	Current transfer ratio	CTR	$I_F=1mA, V_{CE}=5V$	100	-	400	%
	Collector-emitter saturation voltage	$V_{CE(sat)}$	$I_F=20mA, I_c=1mA$	-	0.1	0.2	V
	Isolation resistance	$R_{iso}$	DC500V 40 to 60%RH	$5 \times 10^{10}$	$10^{11}$	-	$\Omega$
	Floating capacitance	$C_f$	$V=0, f=1MHz$	-	0.6	1.0	pF
	Response time (Rise)	$t_r$	$V_{CE}=2V, I_c=2mA$	-	4	18	$\mu s$
	Response time (Fall)	$t_f$	$R_L=100 \Omega$	-	3	18	$\mu s$

(Fig. 1) Forward current vs. ambient temperature

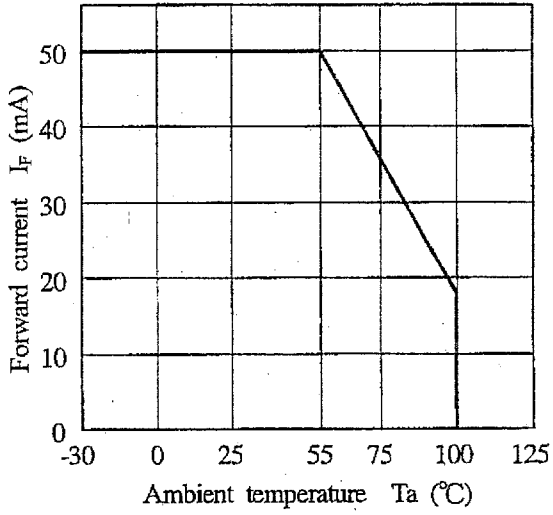

(Fig. 2) Diode power dissipation vs. ambient temperature

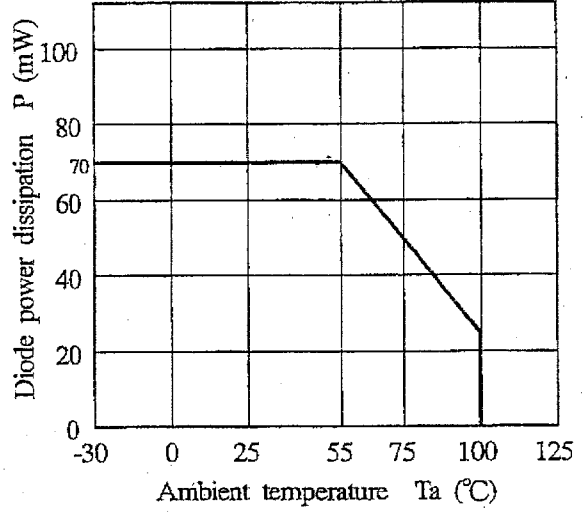

(Fig. 3) Collector power dissipation vs. ambient temperature

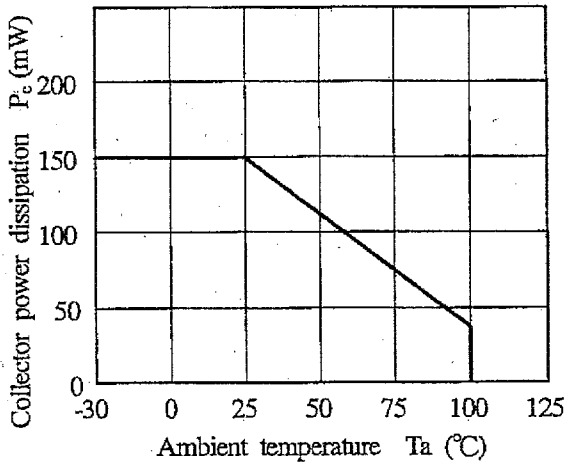

(Fig. 4) Total power dissipation vs. ambient temperature

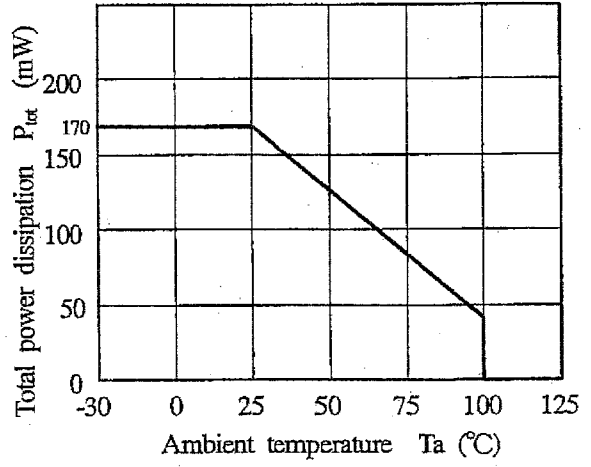

(Fig. 5) Peak forward current vs. duty ratio  
 Pulse width  $\leq 100\mu s$   
 $T_a = 25^\circ C$

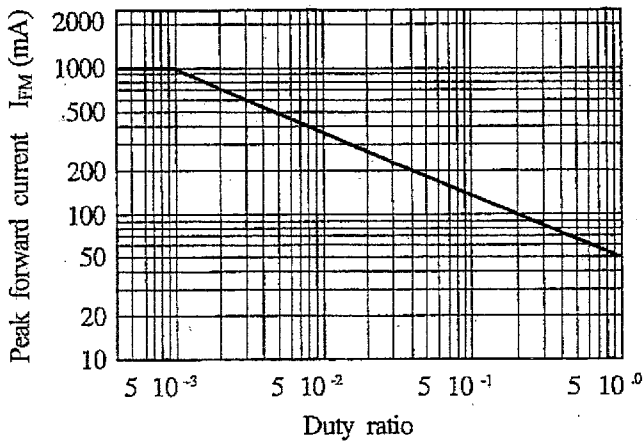

4. Reliability

The reliability of products shall satisfy items listed below.

Confidence level : 90%

LTPD : 10 or 20

Test Items	Test Conditions *1	Failure Judgement Criteria	Samples (n)
			Defective(C)
Solderability *2	245±3°C, 5 s	—————	n=11, C=0
Soldering heat *3	(Flow soldering) 260°C, 10 s	$V_F > U \times 1.2$ $I_R > U \times 2$ $I_{CEO} > U \times 2$ $I_C < L \times 0.7$ $V_{CE(sat)} > U \times 1.2$  U : Upper specification limit L : Lower specification limit	n=11, C=0
	(Soldering by hand) 400°C, 3 s		n=11, C=0
Terminal strength (Bending) *4	Weight : 1N 1 time/each terminal		n=11, C=0
Mechanical shock	15km/s <sup>2</sup> , 0.5ms 3 times/±X, ±Y, ±Z direction		n=11, C=0
Variable frequency vibration	100 to 2000 to 100Hz/4min 200m/s <sup>2</sup> 4 times/ X, Y, Z direction		n=11, C=0
Temperature cycling	1 cycle -40°C. to +125°C (30min) (30min) 20 cycles test		n=22, C=0
High temp. and high humidity storage *5	+85°C, 85%RH, 500h		n=22, C=0
High temp. storage	+125°C, 1000h		n=22, C=0
Low temp. storage	-40°C, 1000h		n=22, C=0
Operation life	I <sub>F</sub> =50mA, P <sub>tot</sub> =170mW Ta=25°C, 1000h		n=22, C=0

- \*1 Test method, conforms to EIAJ ED 4701.
- \*2 Solder shall adhere at the area of 95% or more of immersed portion of lead, and pin hole or other holes shall not be concentrated on one portion.
- \*3 It is evaluated the temperature conditions in attachment-1.
- \*4 Terminal bending direction is shown below.
- \*5 It is evaluated after washing by specified solvent in attachment-1.

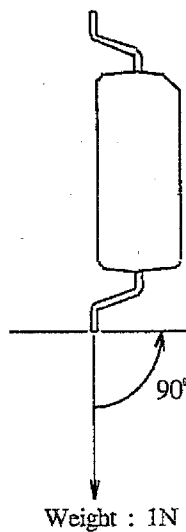

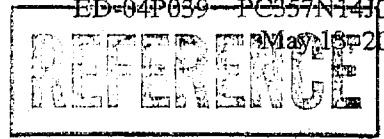

## 5. Outgoing inspection

### 5.1 Inspection items

#### (1) Electrical characteristics

$V_F, I_R, I_{CEO}, V_{CE(sat)}, I_C, R_{ISO}, V_{ISO}$

#### (2) Appearance

### 5.2 Sampling method and Inspection level

A single sampling plan, normal inspection level II based on ISO 2859 is applied.

The AQL according to the inspection items are shown below.

Defect	Inspection item	AQL (%)
Major defect	Electrical characteristics Unreadable marking	0.065
Minor defect	Appearance defect except the above mentioned.	0.25



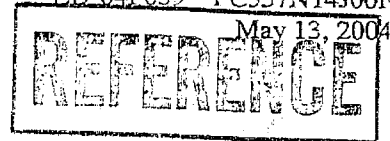

## 6.2 Package specifications

### 6.2.1 Taping conditions

- (1) Tape structure and Dimensions (Refer to the attached sheet, Page 8)

The carrier tape has the heat pressed structure of A-PET material carries tape with preventing static electricity and three layers cover tape (PET material base).

- (2) Reel structure and Dimensions (Refer to the attached sheet, Page 9)

The taping reel shall be of plastic with its dimensions as shown in the attached drawing.

- (3) Direction of product insertion (Refer to the attached sheet, Page 9)

Product direction in carrier tape shall direct to the anode mark at the hole side on the tape.

- (4) Joint of tape The cover tape and carrier tape in one reel shall be jointless.

- (5) To repair taped failure devices cutting a bottom of carrier tape

with a cutter, and after replacing to good devices, the cut portion shall be sealed with adhesive tape.

### 6.2.2 Adhesiveness of cover tape

- The exfoliation force between carrier tape and cover tape shall be 0.2N to 0.7N for the angle 160° to 180°.

### 6.2.3 Rolling method and quantity

- Wind the tape back on the reel so that the cover tape will be outside the tape.

Attach more than 20cm of blank tape to the trailer and more than 60cm

of blank tape to the leader of the tape and fix the both ends with adhesive tape. One reel shall contain 3000pcs.

### 6.2.4 Outer packing appearance

- Refer to the attached sheet, page 9.

### 6.2.5 Marking

- The outer packaging case shall be marked with following information.

\* Model No. \* Number of pieces delivered \* Production date

### 6.2.6 Storage condition

- Taped products shall be stored at the temperature between 5 and 30°C and the humidity lower than 70%RH.

### 6.2.7 Safety protection during shipping

- There shall be no deformation of component or degradation of electrical characteristics due to shipping.

## Carrier tape structure and Dimensions

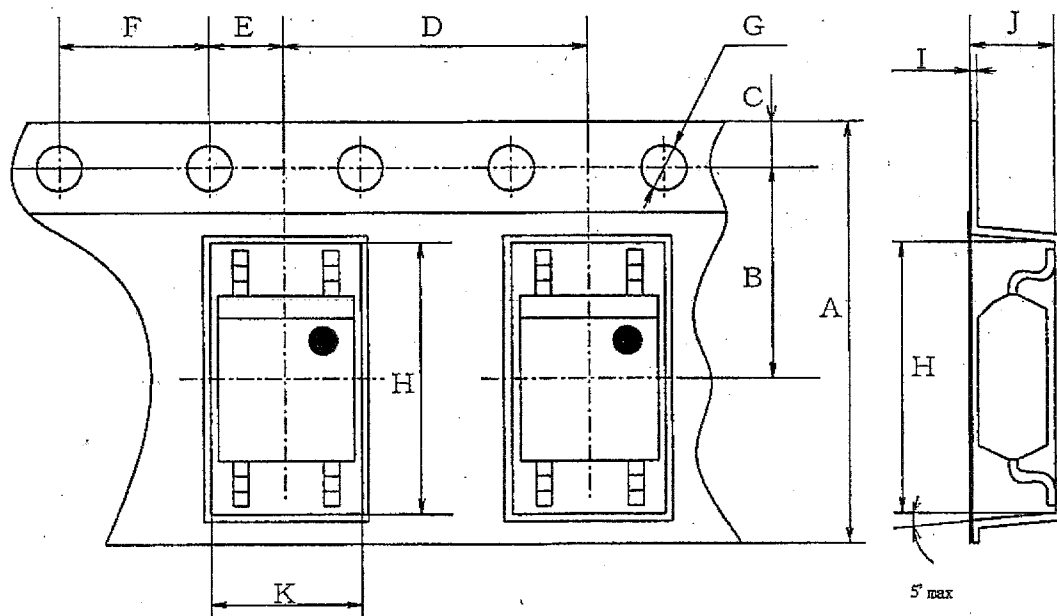

Dimensions list (Unit : mm)

A	B	C	D	E	F	G	H	I	J	K
±0.3	±0.05	±0.1	±0.1	±0.1	±0.1	+0.1 -0.0	±0.1	±0.05	±0.1	±0.1
12.0	5.5	1.75	8.0	2.0	4.0	φ 1.5	7.4	0.3	3.1	4.0

Reel structure and Dimensions

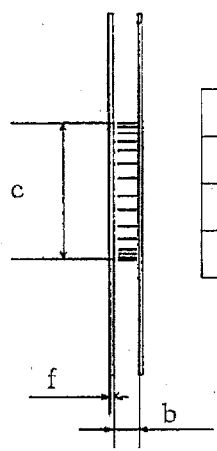
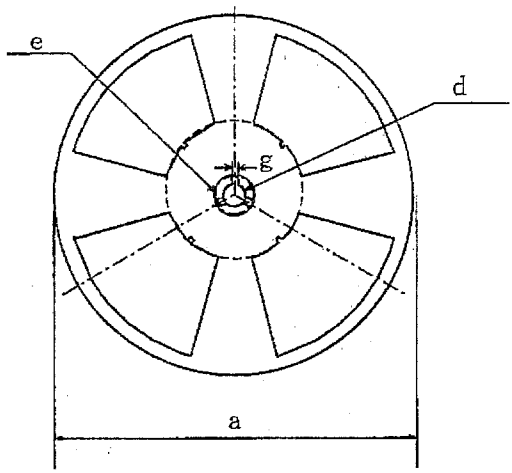

Dimensions list (Unit : mm)

a	b	c	d
370	13.5±1.5	80±1.0	13±0.5
e	f	g	
21±1.0	2.0±0.5	2.0±0.5	

Direction of product insertion

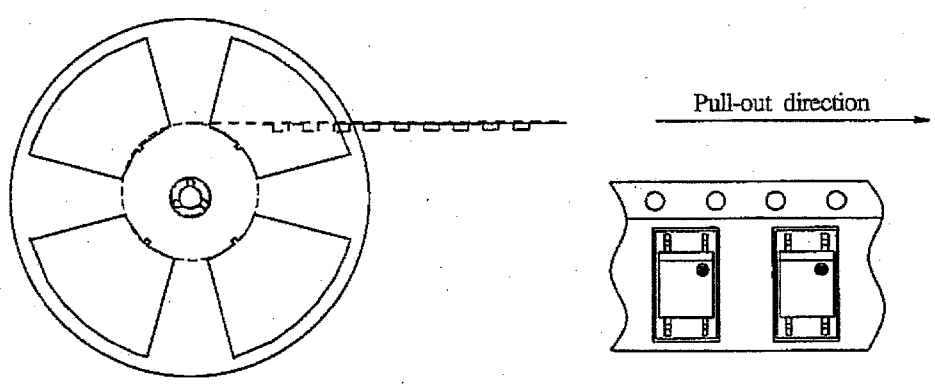

Outer packing appearance

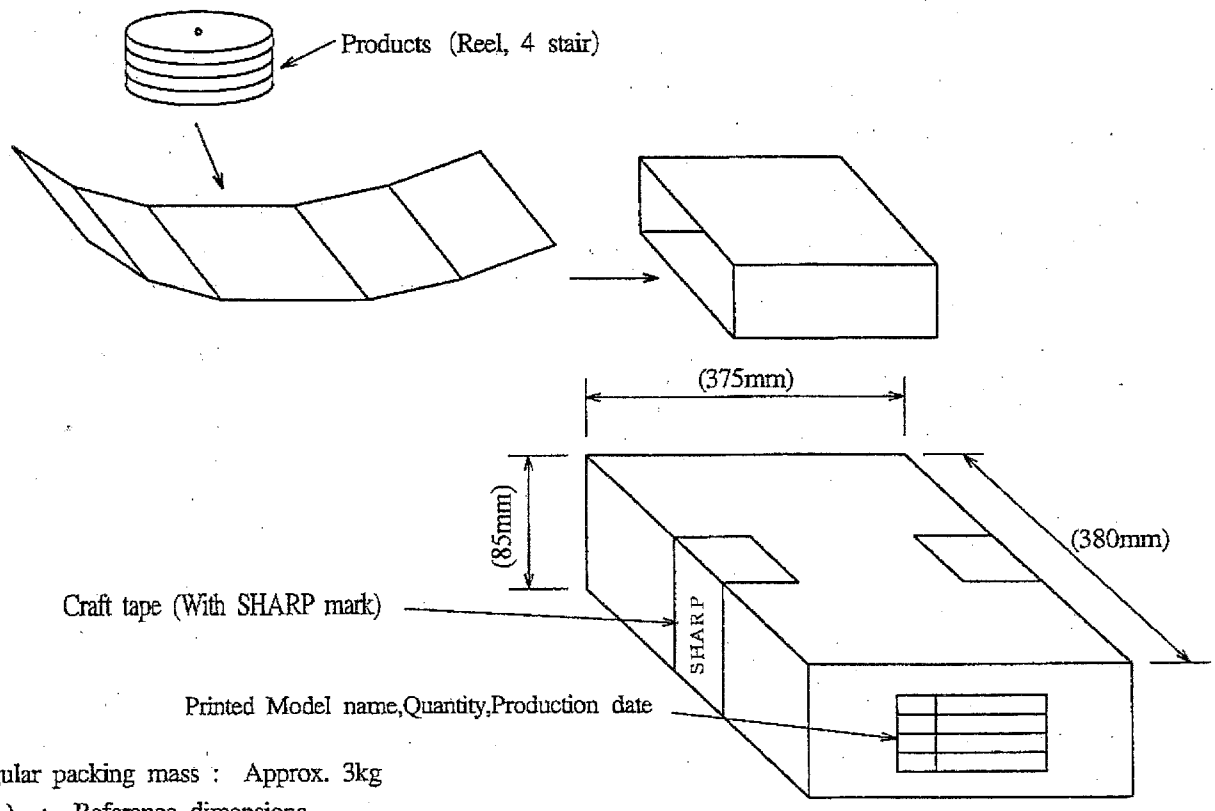

Regular packing mass : Approx. 3kg  
 ( ) : Reference dimensions

Precautions for Photocouplers

1. For cleaning

- (1) Solvent cleaning : Solvent temperature 45°C or less  
 Immersion for 3 min or less
- (2) Ultrasonic cleaning : The effect to device by ultrasonic cleaning differs by cleaning bath size, ultrasonic power output, cleaning time, PCB size or device mounting condition etc. Please test it in actual using condition and confirm that doesn't occur any defect before starting the ultrasonic cleaning.
- (3) Applicable solvent : Ethyl alcohol, Methyl alcohol, Isopropyl alcohol  
 When the other solvent is used, there are cases that the packaging resin is eroded.  
 Please use the other solvent after thorough confirmation is performed in actual using condition.

2. For circuit design

- 2.1 The LED used in the Photocoupler generally decreases the light emission power by operation.  
 In case of long operation time, please design the circuit with considering the degradation of the light emission power of the LED. (50%/5years)
- 2.2 There are cases that the deviation of the CTR and the degradation of the relative light emission power of the LED become big when the setting value of  $I_f$  is less than 1.0mA. Please design the circuit with considering this point.

3. Precautions for Soldering

- (1) In the case of flow soldering (Whole dipping is possible.)  
 It is recommended that flow solder be at 260°C or less and within 10 seconds (Pre-heating : 100 to 150°C, 30 to 80seconds). (2 times or less)
- (2) If solder reflow :  
 It is recommended to be done at the temperature and the time within the temperature profile as shown in the figure below. (2 times or less)

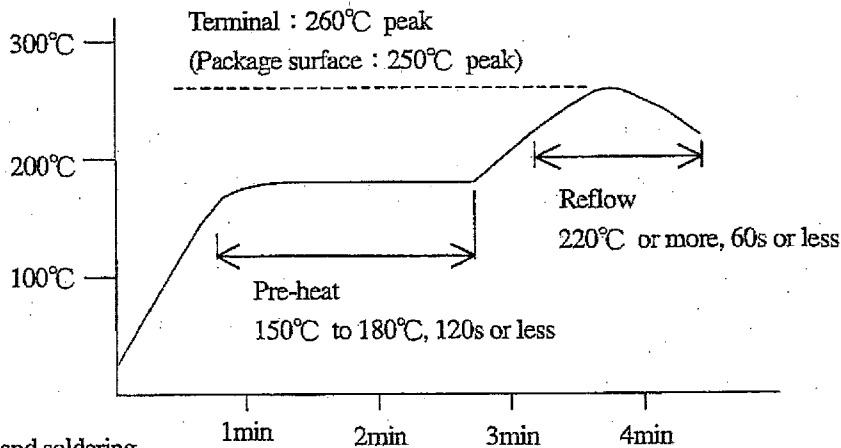

(3) In the case of hand soldering

What is done on the following condition is recommended. (2 times or less)

- Soldering iron temperature : 400°C or less
- Time : 3s or less

(4) Other precautions

Since, influence to the device is different according to reflow equipment and its condition, please use the device after confirming no damage in the actual using condition.