

Intellimod™ Module Single Phase IGBT Inverter Output 450 Amperes/1200 Volts

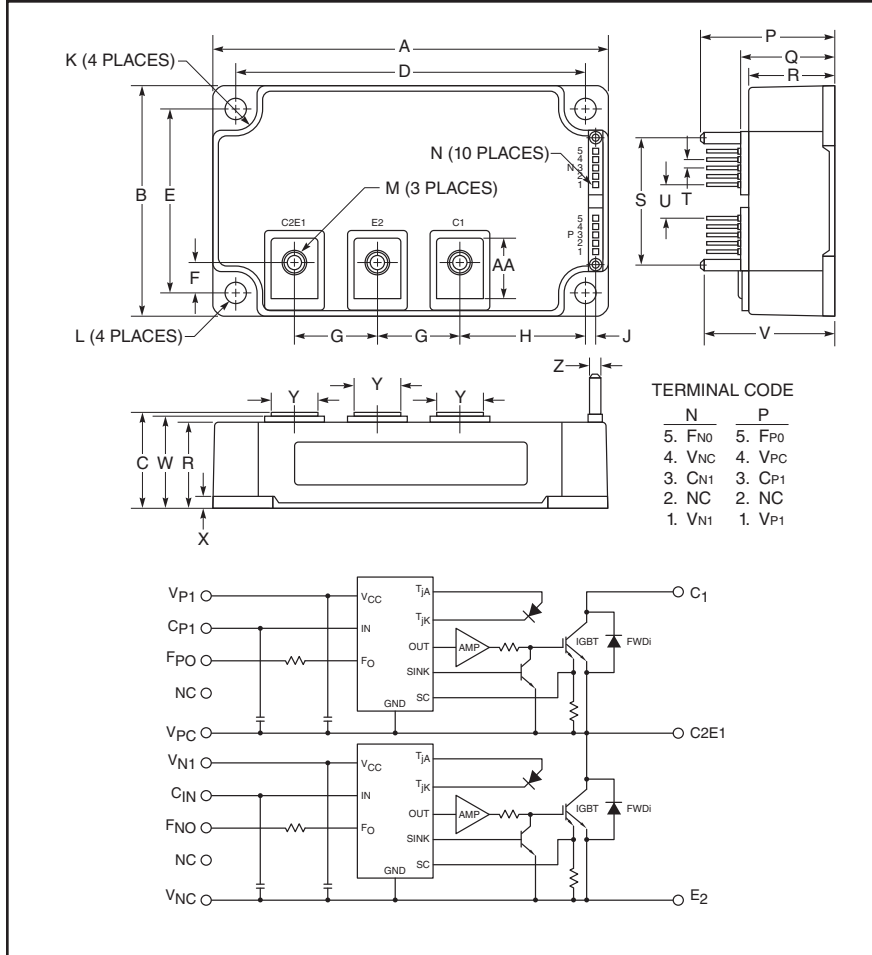

Outline Drawing and Circuit Diagram

Dimensions	Inches	Millimeters
A	4.72	120.0
B	2.76	70.0
C	1.14 +0.04/-0.02	29.0 +1.0/-0.5
D	4.17±0.010	106.0±0.25
E	2.20±0.010	56.0±0.25
F	0.37	9.3
G	0.98	25.0
H	1.50	38.0
J	0.12±0.02	3.0±0.5
K	0.26 Rad.	6.5 Rad.
L	0.26 Dia.	6.5 Dia.
M	M6 Metric	M6
N	0.025 Sq.	0.64 Sq.

Dimensions	Inches	Millimeters
P	1.59	40.5
Q	1.14	29.0
R	1.02	26.0
S	1.52	38.5
T	0.10	2.54
U	0.40	10.16
V	1.54	39.0
W	1.10	28.0
X	0.14	3.5
Y	0.55	14.0
Z	0.14 Dia.	3.5 Dia.
AA	0.72	18.3



Description:

Powerex Intellimod™ Intelligent Power Modules are isolated base modules designed for power switching applications operating at frequencies to 20kHz. Built-in control circuits provide optimum gate drive and protection for the IGBT and free-wheel diode power devices.

Features:

- Complete Output Power Circuit
- Gate Drive Circuit
- Protection Logic
 - Short Circuit
 - Over Temperature
 - Under Voltage

Applications:

- Inverters
- UPS
- Motion/Servo Control
- Power Supplies

Ordering Information:

Example: Select the complete part number from the table below -i.e. PM450DV1A120 is a 1200V, 450 Ampere Intellimod™ Intelligent Power Module.

Type	Current Rating Amperes	V _{CES} Volts (x 10)
PM	450	120



Powerex, Inc., 173 Pavilion Lane, Youngwood, Pennsylvania 15697 (724) 925-7272 www.pwr.com

PM450DV1A120
Intellimod™ Module
Single Phase IGBT Inverter Output
 450 Amperes/1200 Volts

Absolute Maximum Ratings, $T_j = 25^\circ\text{C}$ unless otherwise specified

Characteristics	Symbol	PM450DV1A120	Units
Power Device Junction Temperature	T_j	-20 to 150	$^\circ\text{C}$
Storage Temperature	T_{stg}	-40 to 125	$^\circ\text{C}$
Case Operating Temperature	T_C	-20 to 100	$^\circ\text{C}$
Mounting Torque, M6 Mounting Screws (Typical)	—	43	in-lb
Mounting Torque, M6 Main Terminal Screws (Typical)	—	43	in-lb
Module Weight (Typical)	—	510	Grams
Supply Voltage Protected by SC ($V_D = 13.5 \sim 16.5\text{V}$, Inverter Part, $T_j = 125^\circ\text{C}$ Start)	$V_{CC(prot)}$	800	Volts
Surge Supply Voltage (Applied between C1-E2, Surge Value)	$V_{CC(surge)}$	1000	Volts
Isolation Voltage, (60Hz, Sinusoidal, Charged Part to Base, AC 1 minute)	V_{RMS}	2500	Volts

Inverter Sector

Collector-Emitter Voltage ($V_D = 15\text{V}$, $V_{CIN} = 15\text{V}$)	V_{CES}	1200	Volts
Collector Current ($T_C = 25^\circ\text{C}$)	I_C	450	Amperes
Peak Collector Current (Pulse)	I_{CRM}	900	Amperes
Emitter Current ($T_C = 25^\circ\text{C}$)	I_E	450	Amperes
Peak Emitter Current (Pulse)	I_{ERM}	900	Amperes
Total Power Dissipation ($T_C = 25^\circ\text{C}$)* ¹	P_{tot}	2232	Watts

Control Sector

Supply Voltage (Applied Between $V_{P1}-V_{PC}$, $V_{N1}-V_{NC}$)	V_D	20	Volts
Input Voltage (Applied Between $C_{P1}-V_{PC}$, $V_{N1}-V_{NC}$)	V_{CIN}	20	Volts
Fault Output Supply Voltage (Applied Between $F_{PO}-V_{PC}$, $F_{NO}-V_{NC}$)	V_{FO}	20	Volts
Fault Output Current (Sink Current at F_{PO} , F_{NO} Terminals)	I_{FO}	20	mA

*¹ Case temperature (T_C) measured point is just under the chips.



Powerex, Inc., 173 Pavilion Lane, Youngwood, Pennsylvania 15697 (724) 925-7272 www.pwr.com

PM450DV1A120
Intellimod™ Module
Single Phase IGBT Inverter Output
450 Amperes/1200 Volts

Electrical and Mechanical Characteristics, $T_j = 25^\circ\text{C}$ unless otherwise specified

Characteristics	Symbol	Test Conditions	Min.	Typ.	Max.	Units
IGBT Inverter Sector						
Collector-Emitter Saturation Voltage	$V_{CE(sat)}$	$V_D = 15\text{V}, V_{CIN} = 0\text{V}, I_C = 450\text{A},$ Pulsed, $T_j = 25^\circ\text{C}$	—	1.65	2.15	Volts
		$V_D = 15\text{V}, V_{CIN} = 0\text{V}, I_C = 450\text{A},$ Pulsed, $T_j = 125^\circ\text{C}$	—	1.85	2.35	Volts
Emitter-Collector Voltage	V_{EC}	$I_E = 450\text{A}, V_D = 15\text{V}, V_{CIN} = 15\text{V}$	—	2.3	3.3	Volts
Switching Times	t_{on}	$V_D = 15\text{V}, V_{CIN} = 0 \sim 15\text{V},$	0.3	0.8	2.0	μs
	t_{rr}	$V_{CC} = 600\text{V}, I_C = 450\text{A},$	—	0.3	0.8	μs
	$t_{C(on)}$	$T_j = 125^\circ\text{C},$	—	0.4	1.0	μs
	t_{off}	Inductive Load	—	2.4	3.3	μs
	$t_{C(off)}$	(Per 1 Arm)	—	0.4	1.2	μs
Collector-Emitter Cutoff Current	I_{CES}	$V_{CE} = V_{CES}, V_D = 15\text{V},$ $V_{CIN} = 15, T_j = 25^\circ\text{C}$	—	—	1.0	mA
		$V_{CE} = V_{CES}, V_D = 15\text{V},$ $V_{CIN} = 15, T_j = 125^\circ\text{C}$	—	—	10.0	mA

Control Sector

Circuit Current	I_D	$V_D = 15\text{V}, V_{CIN} = 15\text{V}, V_{P1}-V_{PC}$	—	2	4	mA
		$V_D = 15\text{V}, V_{CIN} = 15\text{V}, V_{N1}-V_{NC}$	—	2	4	mA
Input ON Threshold Voltage	$V_{th(on)}$	Applied Between	1.2	1.5	1.8	Volts
Input OFF Threshold Voltage	$V_{th(off)}$	$C_{P1}-V_{PC}, C_{N1}-V_{NC}$	1.7	2.0	2.3	Volts
Short Circuit Trip Level	SC	$-20^\circ\text{C} \leq T_j \leq 125^\circ\text{C}, V_D = 15\text{V}$	675	—	—	Amperes
Short Circuit Current Delay Time	$t_{off(SC)}$	$V_D = 15\text{V}$	—	0.2	—	μs
Over Temperature Protection (Detect Temperature of Chip)	OT	Trip Level	135	—	—	$^\circ\text{C}$
	$OT_{(hys)}$	Reset Level	—	20	—	$^\circ\text{C}$
Supply Circuit Under Voltage Protection ($T_j \leq 125^\circ\text{C}$)	UV	Trip Level	11.5	12.0	12.5	Volts
	UV_r	Hysteresis	—	12.5	—	Volts
Fault Output Current	$I_{FO(H)}$	$V_D = 15\text{V}, V_{FO} = 15\text{V}^{*2}$	—	—	0.01	mA
	$I_{FO(L)}$	$V_D = 15\text{V}, V_{FO} = 15\text{V}^{*2}$	—	10	15	mA
Fault Output Pulse Width	t_{FO}	$V_D = 15\text{V}^{*2}$	1.0	1.8	—	ms

*2 Fault output is given only when the internal SC, OT and UV protection.
 Fault output of SC, OT and UV protection operate by lower arms.
 Fault output of SC protection given pulse.
 Fault output of OT, UV protection given pulse while over trip level.



Powerex, Inc., 173 Pavilion Lane, Youngwood, Pennsylvania 15697 (724) 925-7272 www.pwr.com

PM450DV1A120
Intellimod™ Module
Single Phase IGBT Inverter Output
450 Amperes/1200 Volts

Thermal Characteristics

Characteristic	Symbol	Condition	Min.	Typ.	Max.	Units
Junction to Case Thermal Resistance	$R_{th(j-c)Q}$	Inverter IGBT (Per 1 Element) ^{*1}	—	—	0.056	K/Watt
	$R_{th(j-c)D}$	Inverter FWDi (Per 1 Element) ^{*1}	—	—	0.079	K/Watt
Contact Thermal Resistance	$R_{th(c-s)}$	Case to Heatsink (Per 1 Module), Thermal Grease Applied ^{*1}	—	0.018	—	K/Watt

Recommended Conditions for Use

Characteristic	Symbol	Condition	Value	Units
Supply Voltage	V_{CC}	Applied Across C1-E2 Terminals	≤ 800	Volts
Control Supply Voltage	V_D	Applied Between $V_{P1-V_{PC}}$, $V_{N1-V_{NC}}$ ^{*3}	15 ± 1.5	Volts
Input ON Voltage	$V_{CIN(on)}$	Applied Between	≤ 0.8	Volts
Input OFF Voltage	$V_{CIN(off)}$	$C_{P1-V_{PC}}$, $C_{N1-V_{NC}}$	≥ 4.0	Volts
PWM Input Frequency	f_{PWM}	Using Application Circuit	≤ 20	kHz
Arm Shoot-Through Blocking Time	t_{DEAD}	For IPM's each Input Signal	≥ 3.5	μs

^{*1} Case temperature (T_C) measured point is just under the chips.

^{*3} With ripple satisfying the following conditions: dv/dt swing $\leq \pm 5V/\mu s$, variation $\leq 2V$ peak to peak.



PM450DV1A120
Intellimod™ Module
Single Phase IGBT Inverter Output
450 Amperes/1200 Volts

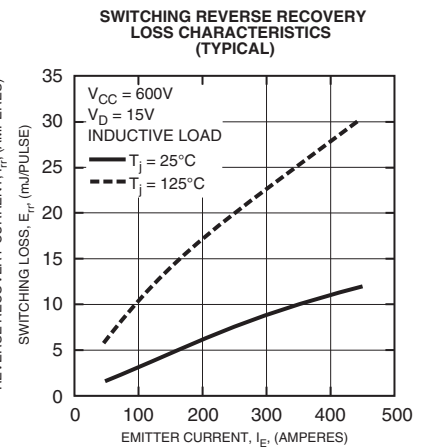
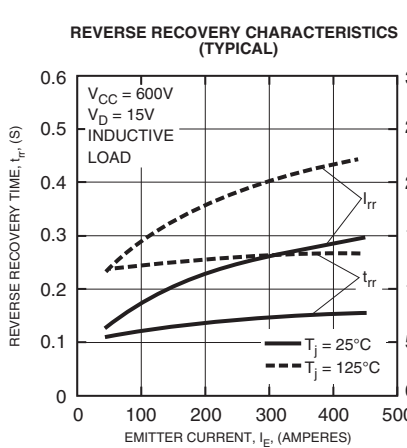
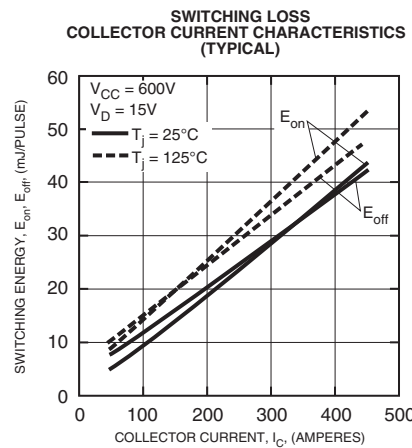
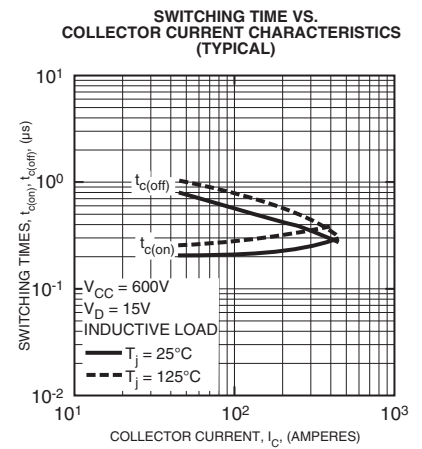
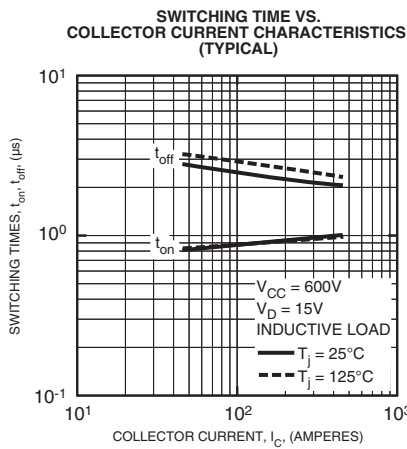
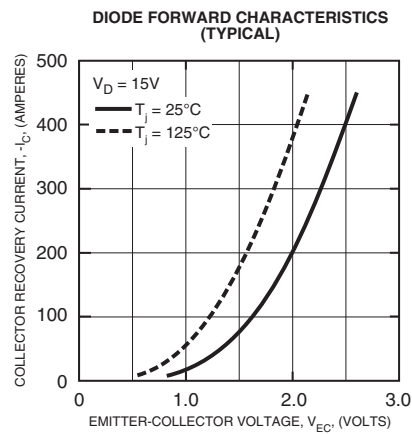
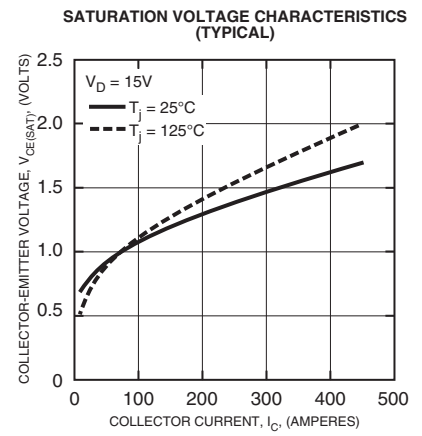
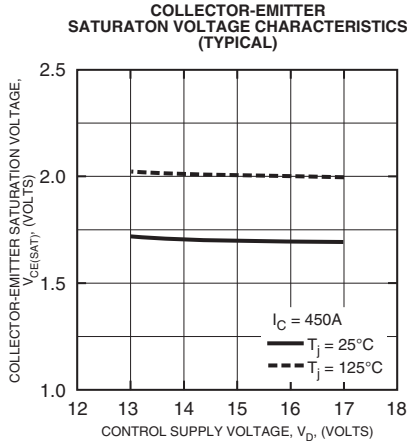
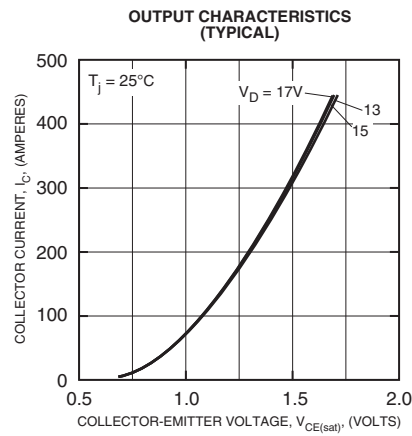



PM450DV1A120
Intellimod™ Module
Single Phase IGBT Inverter Output
450 Amperes/1200 Volts

CIRCUIT CURRENT VS. FREQUENCY CURRENT (TYPICAL)

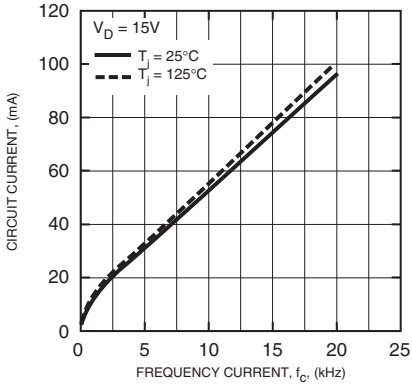

CONTROL SUPPLY VOLTAGE TRIP-RESET LEVEL TEMPERATURE DEPENDENCY (TYPICAL)

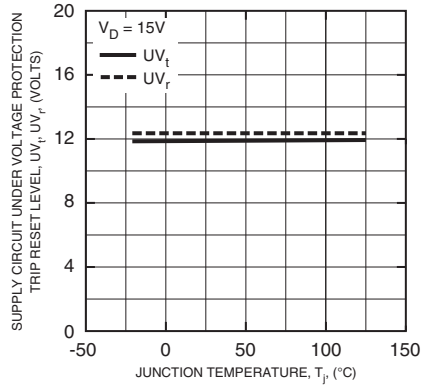

SHORT CIRCUIT TRIP LEVEL VS. JUNCTION TEMPERATURE (TYPICAL)

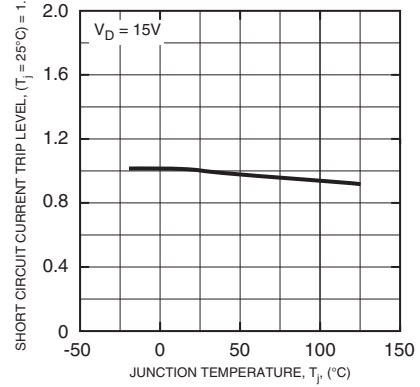

TRANSIENT THERMAL IMPEDANCE CHARACTERISTICS (IGBT)

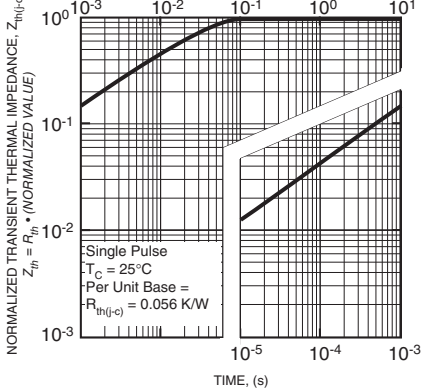

TRANSIENT THERMAL IMPEDANCE CHARACTERISTICS (FWDI)

