



October 2014

# CNY171M, CNY172M, CNY173M, CNY174M, CNY17F1M, CNY17F2M, CNY17F3M, CNY17F4M, MOC8106M 6-Pin DIP High $V_{CEO}$ Phototransistor Optocouplers

## Features

- High  $V_{CEO}$ : 70 V Minimum (CNY17XM, CNY17FXM, MOC8106M)
- Closely Matched Current Transfer Ratio (CTR) Minimizes Unit-to-Unit Variation
- Current Transfer Ratio In Select Groups
- Very Low Coupled Capacitance Along With No Chip-to-Pin 6 Base Connection for Minimum Noise Susceptability (CNY17FXM, MOC8106M)
- Safety and Regulatory Approvals:
  - UL1577, 4,170  $V_{AC_{RMS}}$  for 1 Minute
  - DIN-EN/IEC60747-5-5, 850 V Peak Working Insulation Voltage

## Applications

- Power Supply Regulators
- Digital Logic Inputs
- Microprocessor Inputs
- Appliance Sensor Systems
- Industrial Controls

## Description

The CNY17XM, CNY17FXM, and MOC8106M devices consist of a gallium arsenide infrared emitting diode coupled with an NPN phototransistor in a dual in-line package.

## Package Outlines

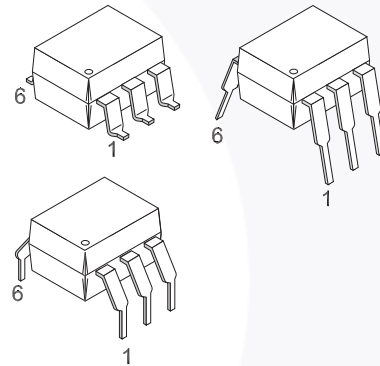

Figure 1. Package Outlines

## Schematics

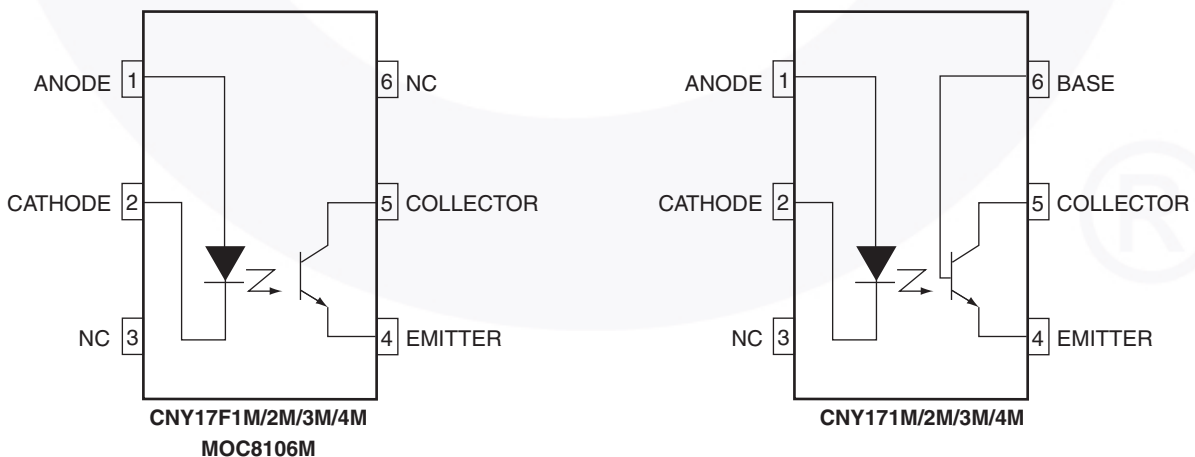

Figure 2. Schematics

CNY17XM, CNY17FXM, MOC8106M — 6-Pin DIP High  $V_{CEO}$  Phototransistor Optocouplers

## Safety and Insulation Ratings

As per DIN EN/IEC 60747-5-5, this optocoupler is suitable for “safe electrical insulation” only within the safety limit data. Compliance with the safety ratings shall be ensured by means of protective circuits.

Parameter		Characteristics
Installation Classifications per DIN VDE 0110/1.89 Table 1, For Rated Mains Voltage	< 150 V <sub>RMS</sub>	I–IV
	< 300 V <sub>RMS</sub>	I–IV
Climatic Classification		55/100/21
Pollution Degree (DIN VDE 0110/1.89)		2
Comparative Tracking Index		175

Symbol	Parameter	Value	Unit
V <sub>PR</sub>	Input-to-Output Test Voltage, Method A, V <sub>IORM</sub> × 1.6 = V <sub>PR</sub> , Type and Sample Test with t <sub>m</sub> = 10 s, Partial Discharge < 5 pC	1360	V <sub>peak</sub>
	Input-to-Output Test Voltage, Method B, V <sub>IORM</sub> × 1.875 = V <sub>PR</sub> , 100% Production Test with t <sub>m</sub> = 1 s, Partial Discharge < 5 pC	1594	V <sub>peak</sub>
V <sub>IORM</sub>	Maximum Working Insulation Voltage	850	V <sub>peak</sub>
V <sub>IOTM</sub>	Highest Allowable Over-Voltage	6000	V <sub>peak</sub>
	External Creepage	≥ 7	mm
	External Clearance	≥ 7	mm
	External Clearance (for Option TV, 0.4" Lead Spacing)	≥ 10	mm
DTI	Distance Through Insulation (Insulation Thickness)	≥ 0.5	mm
T <sub>S</sub>	Case Temperature <sup>(1)</sup>	175	°C
I <sub>S,INPUT</sub>	Input Current <sup>(1)</sup>	350	mA
P <sub>S,OUTPUT</sub>	Output Power <sup>(1)</sup>	800	mW
R <sub>IO</sub>	Insulation Resistance at T <sub>S</sub> , V <sub>IO</sub> = 500 V <sup>(1)</sup>	> 10 <sup>9</sup>	Ω

**Note:**

1. Safety limit values – maximum values allowed in the event of a failure.

## Absolute Maximum Ratings

Stresses exceeding the absolute maximum ratings may damage the device. The device may not function or be operable above the recommended operating conditions and stressing the parts to these levels is not recommended. In addition, extended exposure to stresses above the recommended operating conditions may affect device reliability. The absolute maximum ratings are stress ratings only.

Symbol	Parameters	Value	Units
<b>TOTAL DEVICE</b>			
T <sub>STG</sub>	Storage Temperature	-40 to +125	°C
T <sub>A</sub>	Ambient Operating Temperature	-40 to +100	°C
T <sub>J</sub>	Junction Temperature	-40 to +125	°C
T <sub>SOL</sub>	Lead Solder Temperature	260 for 10 seconds	°C
P <sub>D</sub>	Total Device Power Dissipation @ 25°C (LED plus detector) Derate Linearly From 25°C	270	mW
		2.94	mW/°C
<b>EMITTER</b>			
I <sub>F</sub>	Continuous Forward Current	60	mA
V <sub>R</sub>	Reverse Voltage	6	V
I <sub>F</sub> (pk)	Forward Current – Peak (1 μs pulse, 300 pps)	1.5	A
P <sub>D</sub>	LED Power Dissipation 25°C Ambient Derate Linearly From 25°C	120	mW
		1.41	mW/°C
<b>DETECTOR</b>			
I <sub>C</sub>	Continuous Collector Current	50	mA
V <sub>CEO</sub>	Collector-Emitter Voltage	70	V
V <sub>ECO</sub>	Emitter Collector Voltage	7	V
P <sub>D</sub>	Detector Power Dissipation @ 25°C Derate Linearly from 25°C	150	mW
		1.76	mW/°C

## Electrical Characteristics

$T_A = 25^\circ\text{C}$  unless otherwise specified.

### Individual Component Characteristics

Symbol	Parameters	Test Conditions	Device	Min.	Typ.	Max.	Units
<b>EMITTER</b>							
$V_F$	Input Forward Voltage	$I_F = 10\text{ mA}$	All Devices	1.0	1.15	1.50	V
		$I_F = 60\text{ mA}$	CNY17XM, CNY17FXM	1.0	1.35	1.65	v
$C_J$	Capacitance	$V_F = 0\text{ V}, f = 1.0\text{ MHz}$	All Devices		18		pF
$I_R$	Reverse Leakage Current	$V_R = 6\text{ V}$	All Devices		0.001	10	$\mu\text{A}$
<b>DETECTOR</b>							
$BV_{CEO}$	Breakdown Voltage Collector-to-Emitter	$I_C = 1\text{ mA}, I_F = 0$	All Devices	70	100		V
			CNY17XM	70	120		V
$BV_{CBO}$	Collector-to-Base	$I_C = 10\text{ }\mu\text{A}, I_F = 0$	CNY17XM	70	120		V
$BV_{ECO}$	Emitter-to-Collector	$I_E = 100\text{ }\mu\text{A}, I_F = 0$	All Devices	7	10		V
$I_{CEO}$	Leakage Current Collector-to-Emitter	$V_{CE} = 10\text{ V}, I_F = 0$	All Devices		1	50	nA
			CNY17XM			20	nA
$I_{CBO}$	Collector-to-Base	$V_{CB} = 10\text{ V}, I_F = 0$	CNY17XM			20	nA
$C_{CE}$	Capacitance Collector-to-Emitter	$V_{CE} = 0, f = 1\text{ MHz}$	All Devices		8		pF
			CNY17XM		20		pF
			CNY17XM		10		pF
$C_{CB}$	Collector-to-Base	$V_{CB} = 0, f = 1\text{ MHz}$	CNY17XM		20		pF
$C_{EB}$	Emitter-to-Base	$V_{EB} = 0, f = 1\text{ MHz}$	CNY17XM		10		pF

### Transfer Characteristics

Symbol	Parameters	Test Conditions	Device	Min.	Typ.	Max.	Units
<b>COUPLED</b>							
CTR	Current Transfer Ratio	$I_F = 10\text{ mA}, V_{CE} = 10\text{ V}$	MOC8106M	50		150	%
		$I_F = 10\text{ mA}, V_{CE} = 5\text{ V}$	CNY171M, CNY17F1M	40		80	%
		$I_F = 10\text{ mA}, V_{CE} = 5\text{ V}$	CNY172M, CNY17F2M	63		125	%
		$I_F = 10\text{ mA}, V_{CE} = 5\text{ V}$	CNY173M, CNY17F3M	100		200	%
		$I_F = 10\text{ mA}, V_{CE} = 5\text{ V}$	CNY174M, CNY17F4M	160		320	%
$V_{CE(SAT)}$	Collector-Emitter Saturation Voltage	$I_C = 0.5\text{ mA}, I_F = 5\text{ mA}$	MOC8106M			0.4	V
		$I_C = 2.5\text{ mA}, I_F = 10\text{ mA}$	CNY17XM/CNY17FXM			0.4	V

## Electrical Characteristics (Continued)

T<sub>A</sub> = 25°C unless otherwise specified.

### AC Characteristics

Symbol	Parameters	Test Conditions	Device	Min.	Typ.	Max.	Units
<b>NON-SATURATED SWITCHING TIME</b>							
t <sub>on</sub>	Turn-On Time	I <sub>C</sub> = 2.0 mA, V <sub>CC</sub> = 10 V, R <sub>L</sub> = 100 Ω	All Devices		2.0	10.0	μs
t <sub>off</sub>	Turn-Off Time	I <sub>C</sub> = 2.0 mA, V <sub>CC</sub> = 10 V, R <sub>L</sub> = 100 Ω	All Devices		3.0	10.0	μs
t <sub>d</sub>	Delay Time	I <sub>F</sub> = 10 mA, V <sub>CC</sub> = 5 V, R <sub>L</sub> = 75 Ω	CNY17XM/CNY17FXM			5.6	μs
t <sub>r</sub>	Rise Time	I <sub>F</sub> = 10 mA, V <sub>CC</sub> = 5 V, R <sub>L</sub> = 75 Ω	CNY17XM/CNY17FXM			4.0	μs
t <sub>s</sub>	Storage Time	I <sub>F</sub> = 10 mA, V <sub>CC</sub> = 5 V, R <sub>L</sub> = 75 Ω	CNY17XM/CNY17FXM			4.1	μs
t <sub>f</sub>	Fall Time	I <sub>F</sub> = 10 mA, V <sub>CC</sub> = 5 V, R <sub>L</sub> = 75 Ω	CNY17XM/CNY17FXM			3.5	μs
<b>SATURATED SWITCHING TIMES</b>							
t <sub>d</sub>	Delay Time	I <sub>F</sub> = 20 mA, V <sub>CC</sub> = 5 V, R <sub>L</sub> = 1 kΩ	CNY171M/F1M			5.5	μs
		I <sub>F</sub> = 10 mA, V <sub>CC</sub> = 5 V, R <sub>L</sub> = 1 kΩ	CNY172M/3M/4M CNY17F2M/F3M/F4M			8.0	μs
t <sub>r</sub>	Rise Time	I <sub>F</sub> = 20 mA, V <sub>CC</sub> = 5 V, R <sub>L</sub> = 1 kΩ	CNY171M/F1M			4.0	μs
		I <sub>F</sub> = 10 mA, V <sub>CC</sub> = 5 V, R <sub>L</sub> = 1 kΩ	CNY172M/3M/4M CNY17F2M/F3M/F4M			6.0	μs
t <sub>s</sub>	Storage Time	I <sub>F</sub> = 20 mA, V <sub>CC</sub> = 5 V, R <sub>L</sub> = 1 kΩ	CNY171M/F1M			34.0	μs
		I <sub>F</sub> = 10 mA, V <sub>CC</sub> = 5 V, R <sub>L</sub> = 1 kΩ	CNY172M/3M/4M CNY17F2M/F3M/F4M			39.0	μs
t <sub>f</sub>	Fall Time	I <sub>F</sub> = 20 mA, V <sub>CC</sub> = 5 V, R <sub>L</sub> = 1 kΩ	CNY171M/F1M			20.0	μs
		I <sub>F</sub> = 10 mA, V <sub>CC</sub> = 5 V, R <sub>L</sub> = 1 kΩ	CNY172M/3M/4M CNY17F2M/F3M/F4M			24.0	μs

### Isolation Characteristics

Symbol	Characteristic	Test Conditions	Min.	Typ.	Max.	Units
V <sub>ISO</sub>	Input-Output Isolation Voltage	t = 1 Minute	4170			V <sub>AC</sub> <sub>RMS</sub>
C <sub>ISO</sub>	Isolation Capacitance	V <sub>I-O</sub> = 0 V, f = 1 MHz		0.2		pF
R <sub>ISO</sub>	Isolation Resistance	V <sub>I-O</sub> = ±500 VDC, T <sub>A</sub> = 25°C	10 <sup>11</sup>			Ω

## Typical Performance Characteristics

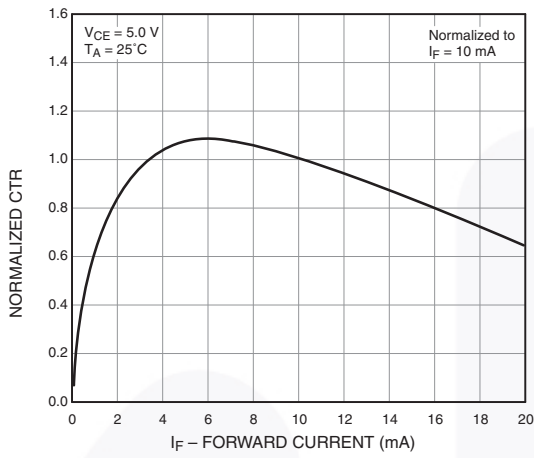

Figure 3. Normalized CTR vs. Forward Current

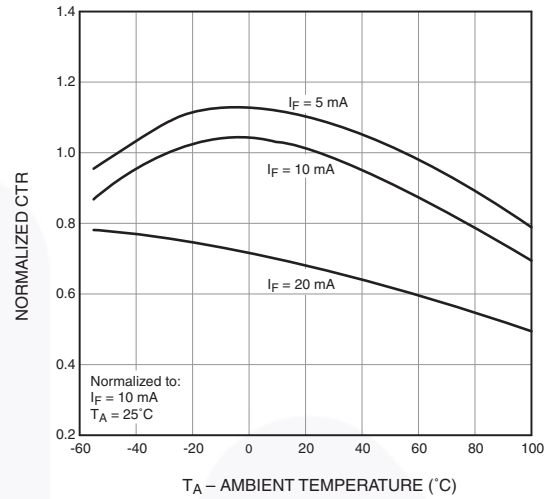

Figure 4. Normalized CTR vs. Ambient Temperature

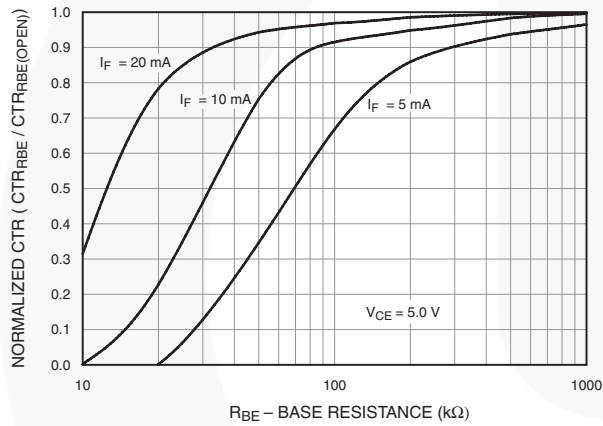

Figure 5. CTR vs. R<sub>BE</sub> (Unsaturated)

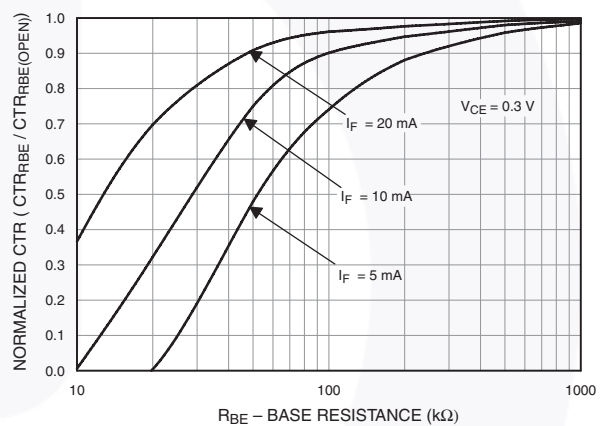

Figure 6. CTR vs. R<sub>BE</sub> (Saturated)

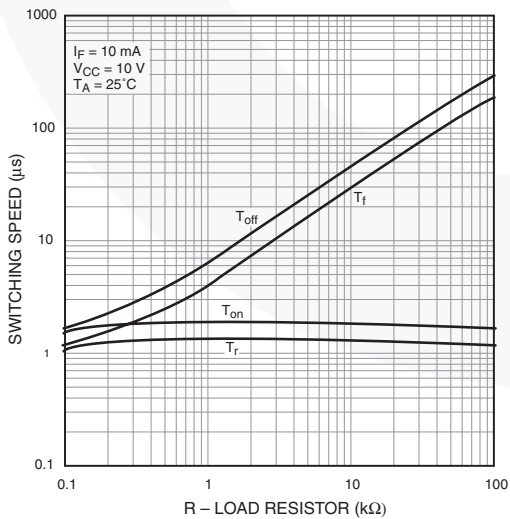

Figure 7. Switching Speed vs. Load Resistor

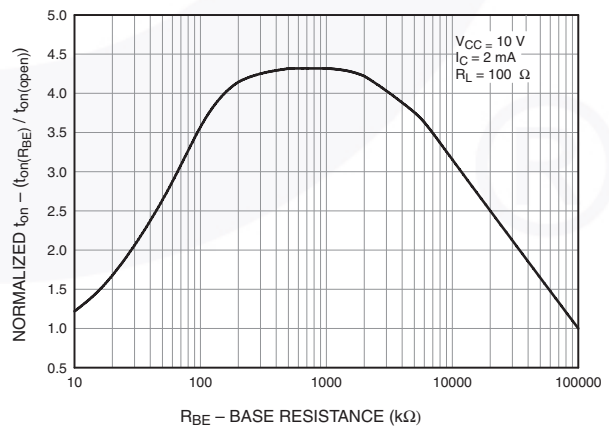

Figure 8. Normalized  $t_{on}$  vs. R<sub>BE</sub>

Typical Performance Characteristics (Continued)

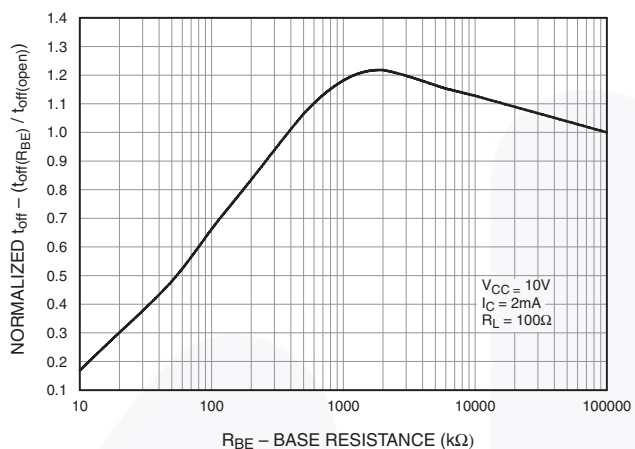

Figure 9. Normalized  $t_{off}$  vs.  $R_{BE}$

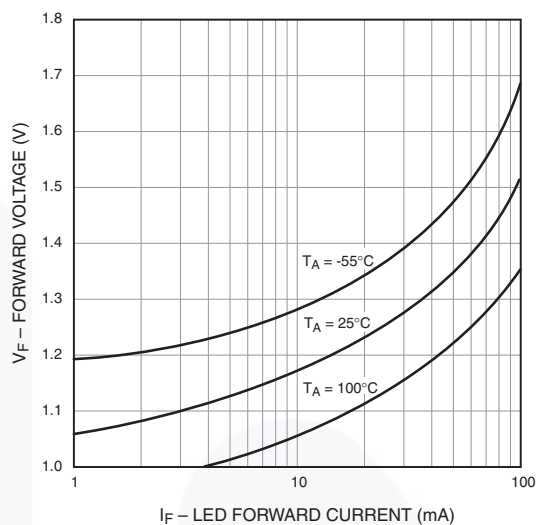

Figure 10. LED Forward Voltage vs. Forward Current

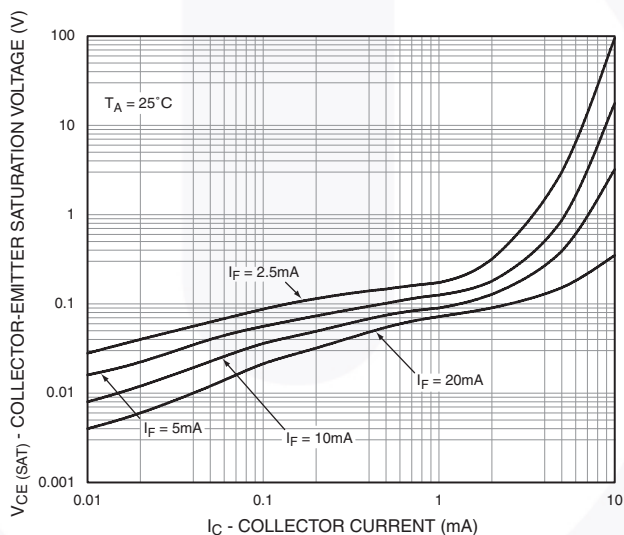

Figure 11. Collector-Emitter Saturation Voltage vs. Collector Current

### Switching Test Circuit and Waveforms

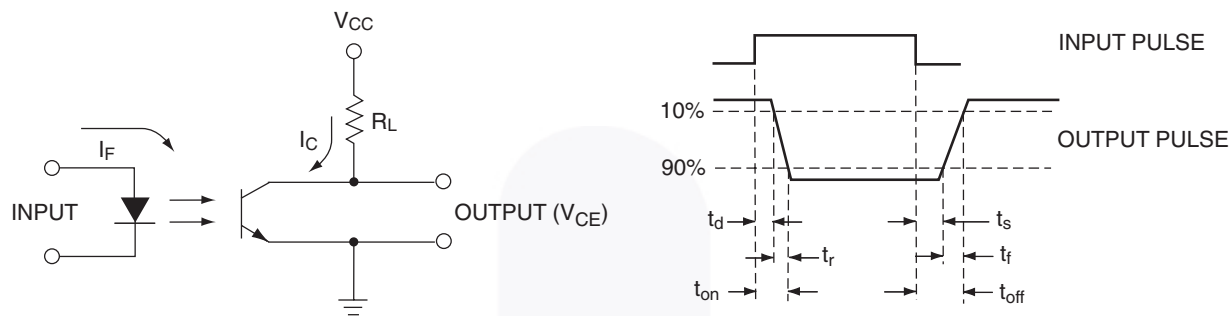

Figure 12. Switching Test Circuit and Waveforms

### Reflow Profile

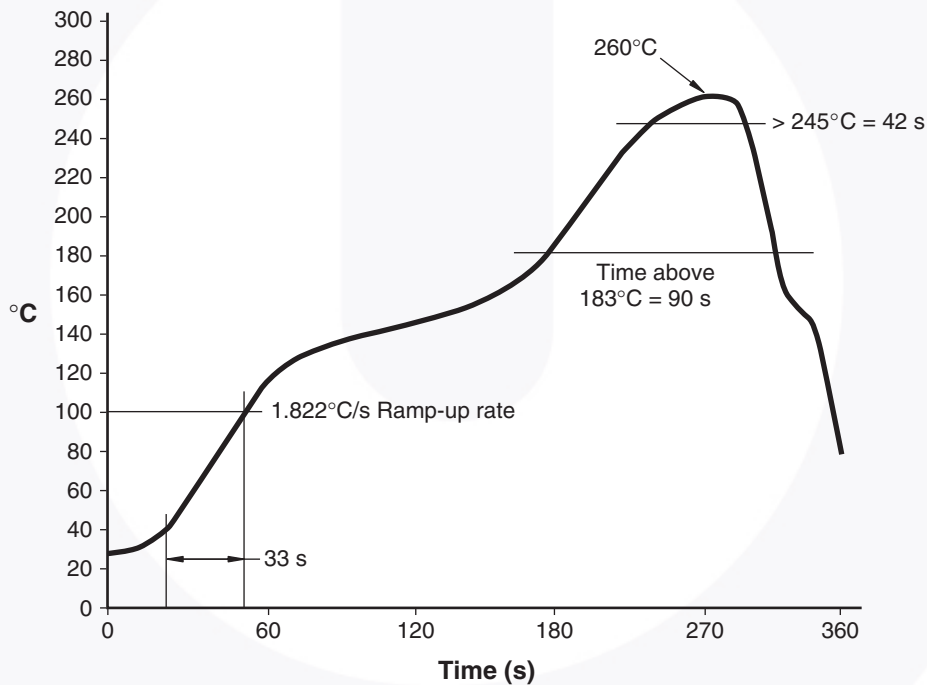

Figure 13. Reflow Profile



## Ordering Information

Part Number	Package	Packing Method
CNY171M	DIP 6-Pin	Tube (50 Units)
CNY171SM	SMT 6-Pin (Lead Bend)	Tube (50 Units)
CNY171SR2M	SMT 6-Pin (Lead Bend)	Tape and Reel (1000 Units)
CNY171TM	DIP 6-Pin, 0.4" Lead Spacing	Tube (50 Units)
CNY171VM	DIP 6-Pin, DIN EN/IEC60747-5-5 Option	Tube (50 Units)
CNY171SVM	SMT 6-Pin (Lead Bend), DIN EN/IEC60747-5-5 Option	Tube (50 Units)
CNY171SR2VM	SMT 6-Pin (Lead Bend), DIN EN/IEC60747-5-5 Option	Tape and Reel (1000 Units)
CNY171TVM	DIP 6-Pin, 0.4" Lead Spacing, DIN EN/IEC60747-5-5 Option	Tube (50 Units)

**Note:**

2. The product orderable part number system listed in this table also applies to the CNY17FXM product family and the MOC8106M device.

## Marking Information

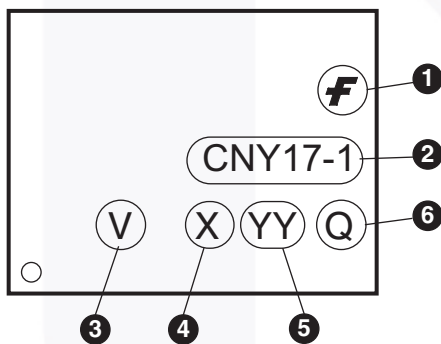
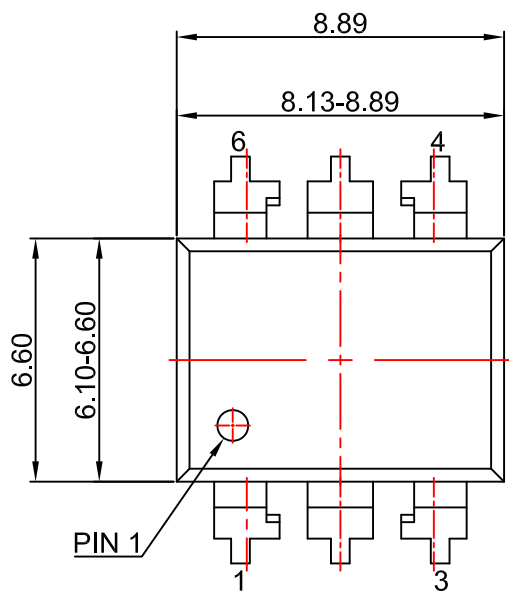

Figure 14. Top Mark

Table 1. Top Mark Definitions

1	Fairchild Logo
2	Device Number
3	DIN EN/IEC60747-5-5 Option (only appears on component ordered with this option)
4	One-Digit Year Code, e.g., "4"
5	Digit Work Week, Ranging from "01" to "53"
6	Assembly Package Code



NOTES:

- A) NO STANDARD APPLIES TO THIS PACKAGE.
- B) ALL DIMENSIONS ARE IN MILLIMETERS.
- C) DIMENSIONS ARE EXCLUSIVE OF BURRS, MOLD FLASH, AND TIE BAR EXTRUSION
- D) DRAWING FILENAME AND REVISION: MKT-N06BREV4.





LAND PATTERN RECOMMENDATION



NOTES:

- A) NO STANDARD APPLIES TO THIS PACKAGE.
- B) ALL DIMENSIONS ARE IN MILLIMETERS.
- C) DIMENSIONS ARE EXCLUSIVE OF BURRS, MOLD FLASH, AND TIE BAR EXTRUSION
- D) DRAWING FILENAME AND REVISION : MKT-N06CREV4.





NOTES:

- A) NO STANDARD APPLIES TO THIS PACKAGE.
- B) ALL DIMENSIONS ARE IN MILLIMETERS.
- C) DIMENSIONS ARE EXCLUSIVE OF BURRS, MOLD FLASH, AND TIE BAR EXTRUSION
- D) DRAWING FILENAME AND REVISION: MKT-N06Drev4







### TRADEMARKS

The following includes registered and unregistered trademarks and service marks, owned by Fairchild Semiconductor and/or its global subsidiaries, and is not intended to be an exhaustive list of all such trademarks.

AccuPower™  
 AttitudeEngine™  
 Awinda®  
 AX-CAP®\*  
 BitSiC™  
 Build it Now™  
 CorePLUS™  
 CorePOWER™  
 CROSSVOL™  
 CTL™  
 Current Transfer Logic™  
 DEUXPEED®  
 Dual Cool™  
 EcoSPARK®  
 EfficientMax™  
 ESBC™  
  
 Fairchild®  
 Fairchild Semiconductor®  
 FACT Quiet Series™  
 FACT®  
 FAST®  
 FastvCore™  
 FETBench™  
 FPS™

F-PFS™  
 FRFET®  
 Global Power Resource™  
 GreenBridge™  
 Green FPS™  
 Green FPS™ e-Series™  
 Gmax™  
 GTO™  
 IntelliMAX™  
 ISOPLANAR™  
 Making Small Speakers Sound Louder and Better™  
 MegaBuck™  
 MICROCOUPLER™  
 MicroFET™  
 MicroPak™  
 MicroPak2™  
 MillerDrive™  
 MotionMax™  
 MotionGrid®  
 MTI®  
 MTX®  
 MVN®  
 mWSaver®  
 OptoHiT™  
 OPTOLOGIC®

OPTOPLANAR®  
  
 Power Supply WebDesigner™  
 PowerTrench®  
 PowerXS™  
 Programmable Active Droop™  
 QFET®  
 QS™  
 Quiet Series™  
 RapidConfigure™  
  
 Saving our world, 1mW/W/kW at a time™  
 SignalWise™  
 SmartMax™  
 SMART START™  
 Solutions for Your Success™  
 SPM®  
 STEALTH™  
 SuperFET®  
 SuperSOT™-3  
 SuperSOT™-6  
 SuperSOT™-8  
 SupreMOS®  
 SyncFET™  
 Sync-Lock™

  
 TinyBoost®  
 TinyBuck®  
 TinyCalc™  
 TinyLogic®  
 TINYOPTO™  
 TinyPower™  
 TinyPWM™  
 TinyWire™  
 TranSiC™  
 TriFault Detect™  
 TRUECURRENT®\*  
 μSerDes™  
  
 UHC®  
 Ultra FRFET™  
 UniFET™  
 VCX™  
 VisualMax™  
 VoltagePlus™  
 XS™  
 Xsens™  
 仙童™

\* Trademarks of System General Corporation, used under license by Fairchild Semiconductor.

### DISCLAIMER

FAIRCHILD SEMICONDUCTOR RESERVES THE RIGHT TO MAKE CHANGES WITHOUT FURTHER NOTICE TO ANY PRODUCTS HEREIN TO IMPROVE RELIABILITY, FUNCTION, OR DESIGN. TO OBTAIN THE LATEST, MOST UP-TO-DATE DATASHEET AND PRODUCT INFORMATION, VISIT OUR WEBSITE AT [HTTP://WWW.FAIRCHILDSEMI.COM](http://www.fairchildsemi.com). FAIRCHILD DOES NOT ASSUME ANY LIABILITY ARISING OUT OF THE APPLICATION OR USE OF ANY PRODUCT OR CIRCUIT DESCRIBED HEREIN; NEITHER DOES IT CONVEY ANY LICENSE UNDER ITS PATENT RIGHTS, NOR THE RIGHTS OF OTHERS. THESE SPECIFICATIONS DO NOT EXPAND THE TERMS OF FAIRCHILD'S WORLDWIDE TERMS AND CONDITIONS, SPECIFICALLY THE WARRANTY THEREIN, WHICH COVERS THESE PRODUCTS.

### LIFE SUPPORT POLICY

FAIRCHILD'S PRODUCTS ARE NOT AUTHORIZED FOR USE AS CRITICAL COMPONENTS IN LIFE SUPPORT DEVICES OR SYSTEMS WITHOUT THE EXPRESS WRITTEN APPROVAL OF FAIRCHILD SEMICONDUCTOR CORPORATION.

As used herein:

1. Life support devices or systems are devices or systems which, (a) are intended for surgical implant into the body or (b) support or sustain life, and (c) whose failure to perform when properly used in accordance with instructions for use provided in the labeling, can be reasonably expected to result in a significant injury of the user.
2. A critical component in any component of a life support, device, or system whose failure to perform can be reasonably expected to cause the failure of the life support device or system, or to affect its safety or effectiveness.

### ANTI-COUNTERFEITING POLICY

Fairchild Semiconductor Corporation's Anti-Counterfeiting Policy. Fairchild's Anti-Counterfeiting Policy is also stated on our external website, [www.fairchildsemi.com](http://www.fairchildsemi.com), under Sales Support.

Counterfeiting of semiconductor parts is a growing problem in the industry. All manufacturers of semiconductor products are experiencing counterfeiting of their parts. Customers who inadvertently purchase counterfeit parts experience many problems such as loss of brand reputation, substandard performance, failed applications, and increased cost of production and manufacturing delays. Fairchild is taking strong measures to protect ourselves and our customers from the proliferation of counterfeit parts. Fairchild strongly encourages customers to purchase Fairchild parts either directly from Fairchild or from Authorized Fairchild Distributors who are listed by country on our web page cited above. Products customers buy either from Fairchild directly or from Authorized Fairchild Distributors are genuine parts, have full traceability, meet Fairchild's quality standards for handling and storage and provide access to Fairchild's full range of up-to-date technical and product information. Fairchild and our Authorized Distributors will stand behind all warranties and will appropriately address any warranty issues that may arise. Fairchild will not provide any warranty coverage or other assistance for parts bought from Unauthorized Sources. Fairchild is committed to combat this global problem and encourage our customers to do their part in stopping this practice by buying direct or from authorized distributors.

### PRODUCT STATUS DEFINITIONS

#### Definition of Terms

Datasheet Identification	Product Status	Definition
Advance Information	Formative / In Design	Datasheet contains the design specifications for product development. Specifications may change in any manner without notice.
Preliminary	First Production	Datasheet contains preliminary data; supplementary data will be published at a later date. Fairchild Semiconductor reserves the right to make changes at any time without notice to improve design.
No Identification Needed	Full Production	Datasheet contains final specifications. Fairchild Semiconductor reserves the right to make changes at any time without notice to improve the design.
Obsolete	Not In Production	Datasheet contains specifications on a product that is discontinued by Fairchild Semiconductor. The datasheet is for reference information only.

Rev. I74