

PLEASE CHECK WWW.MOLEX.COM FOR LATEST PART INFORMATION

Part Number: [18-12-1602](#)
Status: **Active**
Description: 3.18mm Diameter HCS-125 Pin and Socket Crimp Terminal, Series 1901, Female, with Tin (Sn) Plated Brass Contact, 10-14 AWG, Bag

Documents:

[Drawing \(PDF\)](#) [RoHS Certificate of Compliance \(PDF\)](#)
[Product Specification PSX-42179 \(PDF\)](#)

General

Product Family	Crimp Terminals
Series	1901
Application	Power
Crimp Quality Equipment	Yes
MolexKits	Yes
Packaging Alternative	18-12-1601 (Reel)
Product Name	HCS-125
UPC	800754202800

Physical

Gender	Female
Material - Metal	Brass
Material - Plating Mating	Tin
Material - Plating Termination	Tin
Net Weight	0.608/g
Packaging Type	Bag
Plating min - Mating	0.508µm
Plating min - Termination	0.508µm
Termination Interface: Style	Crimp or Compression
Wire Insulation Diameter	4.57mm max.
Wire Size AWG	10, 12, 14
Wire Size mm ²	N/A

Material Info

Old Part Number [19011P901L](#)

Reference - Drawing Numbers

Product Specification [PSX-42179](#)
 Sales Drawing [SD-1901-1*](#)

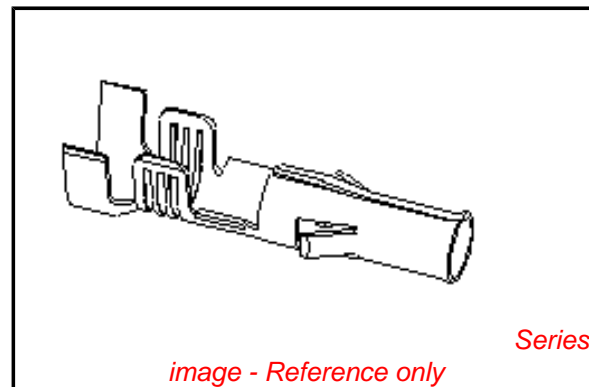

EU RoHS

ELV and RoHS Compliant
REACH SVHC Contains SVHC: No
Low-Halogen Status Low-Halogen

China RoHS



Need more information on product environmental compliance?

Email productcompliance@molex.com
 For a multiple part number RoHS Certificate of Compliance, [click here](#)

Please visit the [Contact Us](#) section for any non-product compliance questions.

Search Parts in this Series

[1901Series](#)

Mates With

[1900 Series](#), [2046 Series](#), [42554 Series](#)

Use With

[42179 Receptacle](#)

Application Tooling | FAQ

Tooling specifications and manuals are found by selecting the products below. Crimp Height Specifications are then contained in the Application Tooling Specification document.

Global

Description	Product #
Extractor Tool for .093 and HCS-125 Product Series	0638240200
Hand Crimper	0638111100

This document was generated on 05/04/2015

PLEASE CHECK WWW.MOLEX.COM FOR LATEST PART INFORMATION