



PRODUCT/PROCESS CHANGE NOTIFICATION

PCN IPD-DIS/12/7461
Dated 04 Sep 2012

IPD - ASD & IPAD Division
Rectifiers in I2PAK & TO-220 packages
New ECOPACK2 molding compound & electroplating generalization

Table 1. Change Implementation Schedule

Forecasted implementation date for change	16-Nov-2012
Forecasted availability date of samples for customer	28-Aug-2012
Forecasted date for STMicroelectronics change Qualification Plan results availability	28-Aug-2012
Estimated date of changed product first shipment	04-Dec-2012

Table 2. Change Identification

Product Identification (Product Family/Commercial Product)	See product series listed in PCN document
Type of change	Package assembly material change
Reason for change	Standardization of our assembly processes
Description of the change	The purpose of this document is to announce the qualification of the Cheil SG-8200DT molding compound and the generalization of the electroplating technique for all production sites of our Power Rectifiers in I2PAK and TO-220AB/AC (including narrow leads) packages.
Change Product Identification	Traceability is ensured by date code and QA number
Manufacturing Location(s)	

Table 3. List of Attachments

Customer Part numbers list	
Qualification Plan results	

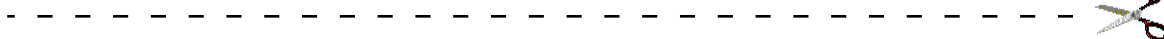

Customer Acknowledgement of Receipt		PCN IPD-DIS/12/7461					
Please sign and return to STMicroelectronics Sales Office		Dated 04 Sep 2012					
<input type="checkbox"/> Qualification Plan Denied <input type="checkbox"/> Qualification Plan Approved <input type="checkbox"/> Change Denied <input type="checkbox"/> Change Approved	<table border="1" style="width: 100%; border-collapse: collapse;"> <tr><td style="padding: 2px;">Name:</td></tr> <tr><td style="padding: 2px;">Title:</td></tr> <tr><td style="padding: 2px;">Company:</td></tr> <tr><td style="padding: 2px;">Date:</td></tr> <tr><td style="padding: 2px;">Signature:</td></tr> </table>		Name:	Title:	Company:	Date:	Signature:
Name:							
Title:							
Company:							
Date:							
Signature:							
Remark							

DOCUMENT APPROVAL

Name	Function
Paris, Eric	Marketing Manager
Duclos, Franck	Product Manager
Cazaubon, Guy	Q.A. Manager



**PRODUCT/PROCESS
CHANGE NOTIFICATION**

PCN IPD-DIS/12/7461

IPD - ASD & IPAD Division¹

Rectifiers in I²PAK & TO-220 packages:

New ECOPACK®2 molding compound & electroplating generalization

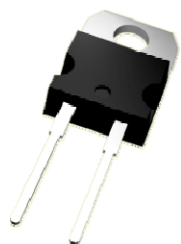

TO-220AC

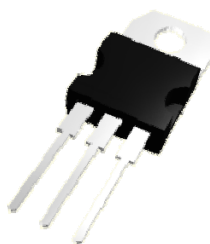

TO-220AB(NL)

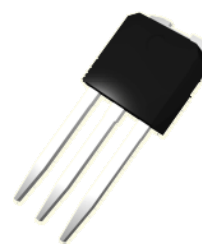

I²PAK

(1) IPD: Industrial, Power & Discretes - ASD: Application Specific Device - IPAD: Integrated Passive and Active Devices

WHY THIS CHANGE?

The purpose of this document is to announce the qualification of the Cheil SG-8200DT **molding compound** and the generalization of the **electroplating technique** for all production sites of our **Power Rectifiers** in **I²PAK** and **TO-220AB/AC** (including narrow leads) packages.

The SG-8200DT molding compound is **widely used** in several plants for **other power ST devices in TO-220AB/TO-247 packages** and with the **generalization of the electroplating technique**, these changes constitute one step forward towards the **standardization** of our assembly processes.

The **product series** involved in this production standardization are listed below.

Product Sub-Family	Product Series	Package
Power Schottky Rectifiers	STPSxxxCR	I ² PAK
	STPSxxxSR	
	STPSxxxCT(N)	TO-220AB(NL)
	STPSxxxST(N)	
	STPSxxxD	TO-220AC
SiC Rectifiers	STPSCxxxD	TO-220AC
Ultrafast Rectifiers	STTHxxxCR	I ² PAK
	STTHxxxSR	
	STTHxxxD	TO-220AC
	STPSxxxR	I ² PAK
	STTHxxxCT	TO-220AB
	STTHxxxST	

Specific devices not expressly listed in the above table are included in these changes. Devices intended for the **automotive market** are also affected by these changes.

WHAT IS THE CHANGE?

The use of the SG-8200DT molding compound has **no impact** on the **electrical, dimensional** and **thermal** parameters, maintaining **unchanged** current information published on the relevant datasheets. The verification is included in the **qualification program**. The involved production sites are located in China, Morocco and Philippines.

While the **electroplating technique** is already implemented for all parts in I²PAK package and for parts in TO-220 packages produced in our Long Gang site, it will be fully extended to the TO-220 production in our Shenzhen site, consequently leading to the **generalization of the plating technique** and to the **discontinuation of the dipping process** for such packages.

The devices produced with the new molding compound comply with the **RoHS*** directive by their **ECOPACK®2** (“halogen-free”) grade and also comply with the **UL 94 V-0** standard.

There is **no change** in the **packing mode** and in the standard **delivery quantities** either.

(*) *Restriction of the use of certain Hazardous Substances according to European Directive 2002/95/CE.*



HOW AND WHEN?Qualification and test results:

The **reliability test plan** supporting the qualification program for the announced changes was defined according to the **AEC Q101 standard**. The **reliability test report** of the qualification program is annexed to the present document.

The production ramp-up will be monitored with a **pre-launch control plan** implemented on selected parameters.

Sampling:

Samples of selected devices, including the test vehicles, are available now for customer qualification if ordered within **30 days** from notification, while the availability of other samples will be granted from production start, upon request.

Change implementation schedule:

The **production start** and **first shipments** will be implemented according to our work in progress and materials availability as indicated in the schedule below:

Salestypes	Production Start	1st Shipments
All	From week 46-2012	From week 49-2012

Absence of acknowledgement of this PCN within **30 days** of receipt will constitute acceptance of the change. After an acknowledgement, unless otherwise previously agreed to in writing for a specific process change requirement or for device specific requirements, absence of additional response within **90 days** of receipt of this PCN will constitute acceptance of the change. **Shipments** may in any case start earlier with the customer's **written agreement**.

Marking and Traceability:

Parts assembled with the SG-8200DT molding compound have the **same marking** as parts produced with the current ECOPACK®2 molding compound. The **traceability** of the molding compound will be ensured by the **date code** and by the **Q.A. number**.

Please note that the marking of the ECOPACK®2 devices includes the **letter "G"** printed to the right of the "e3" symbol of the IPC-JEDEC J-STD 609 standard.

Annex: reliability report for qualification program

- Reliability report **12162QRP-Rev1.0** for Power Rectifiers.



Qualification of
New ECOPACK®2 molding compound & electroplating
generalization for Rectifiers products
in I²PAK & TO-220 packages

General Information		Locations	
Product Line	Rectifiers (BU78)	Wafer fab	STM Singapore STM Tours (France) STM Catania (Italy)
Product Description	Rectifiers in I ² PAK & TO-220 packages: new ECOPACK®2 molding compound & electroplating generalization	Assembly plant	ST Shenzhen (China) ST Long Gang (China) ST Bouskoura (Morocco) Subcontractor in Philippines
Product Group	IPD	Reliability Lab	STM Tours (France)
Product division	ASD & IPAD		
Package	I ² PAK TO-220AB/TO-220AB(NL) TO-220AC		
Maturity level step	Qualified		

DOCUMENT INFORMATION

Version	Date	Pages	Prepared by	Comment
1.0	21-Aug-2012	12	I. BALLON	First issue Qualification of Rectifiers I ² PAK & TO-220 packages: New ECOPACK®2 molding compound & electroplating generalization (Reference document: Product Change Notification PCN IPD-DIS/12/7461)

Note: This report is a summary of the reliability trials performed in good faith by STMicroelectronics in order to evaluate the potential reliability risks during the product life using a set of defined test methods.
 This report does not imply for STMicroelectronics expressly or implicitly any contractual obligations other than as set forth in STMicroelectronics general terms and conditions of Sale. This report and its contents shall not be disclosed to a third party without previous written agreement from STMicroelectronics.



TABLE OF CONTENTS

1 APPLICABLE AND REFERENCE DOCUMENTS 3
2 GLOSSARY..... 3
3 RELIABILITY EVALUATION OVERVIEW 3
 3.1 OBJECTIVES 3
 3.2 CONCLUSION 4
4 DEVICE CHARACTERISTICS 5
 4.1 DEVICE DESCRIPTION 5
 4.2 CONSTRUCTION NOTE 5
5 TESTS RESULTS SUMMARY 6
 5.1 TEST VEHICLES 6
 5.2 TEST PLAN AND RESULTS SUMMARY 6
6 ANNEXES 8
 6.1 DEVICE DETAILS 8
 6.2 TESTS DESCRIPTION 11

1 APPLICABLE AND REFERENCE DOCUMENTS

Document reference	Short description
JESD47	Stress-Test-Driven Qualification of Integrated Circuits
AEC-Q101	Stress test qualification for automotive grade discrete semiconductors
FMEA	8248329
RER	1141014

2 GLOSSARY

DUT	Device Under Test
PCB	Printed Circuit Board
SS	Sample Size
HTRB	High Temperature Reverse Bias
TC	Temperature Cycling
PCT	Pressure Pot 2 bars
THB	Temperature Humidity Bias
IOLT	Intermittent Operational Life
DPA	Destructive Physical Analysis. Random sample of devices that have successfully completed THB and TC
RSH	Resistance to solder Heat
SD	Solderability

3 RELIABILITY EVALUATION OVERVIEW

3.1 Objectives

The objective of this report is to qualify a new ECOPACK®2 **molding compound** (Cheil SG-8200DT) and the generalization of the **electroplating technique** for all production sites of our **Power Rectifiers** in **I²PAK** and **TO-220AB/AC** (including narrow leads) packages.

The product series involved in this production extension are listed below.

Product Sub-Family	Product Series	Package
Power Schottky Rectifiers	STPSxxxCR	I ² PAK
	STPSxxxSR	
	STPSxxxCT(N)	TO-220AB(NL)
	STPSxxxST(N)	
	STPSxxxD	TO-220AC
SiC Rectifiers	STPSCxxxD	TO-220AC
Ultrafast Rectifiers	STTHxxxCR	I ² PAK
	STTHxxxSR	
	STTHxxxD	TO-220AC
	STPSxxxR	I ² PAK
	STTHxxxCT	TO-220AB
	STTHxxxST	

Specific devices not expressly listed in the above table are included in this change. Devices intended for the automotive market are included in this molding compound qualification.

According FMEA 8248329, tests vehicles have been chosen covering the full qualification perimeter.

The following reliability tests are:

- HTRB to evaluate the risk of contamination from the resin and the assembly process versus the die layout sensitivity.
- TC, IOLT, RSH to ensure the mechanical robustness of the products.
- THB, AC to check the robustness to corrosion and the good package hermeticity.
- Solderability to evaluate the risk of resin contamination on leads and to ensure electroplating robustness.

The reliability methodology used in this qualification follows the JESD47-H «Stress Test Driven Qualification Methodology» and AEC-Q101 rev.C for automotive products.

3.2 **Conclusion**

The perimeter addressed in this campaign qualifies the production of Rectifiers housed in I²PAK & TO-220 packages with the new “Halogen-Free” encapsulation molding compound and generalization of electroplating. Reliability tests are positive.

Qualification Plan requirements have been fulfilled without exception. Reliability tests have shown that the devices behave correctly against environmental tests (no failure). Moreover, the stability of electrical parameters during the accelerated tests demonstrates the robustness of the products and safe operation, which is consequently expected during their lifetime.

4 DEVICE CHARACTERISTICS

4.1 Device description

- Rectifiers in I²PAK & TO-220 packages with new ECOPACK®2 molding compound & electroplating.

4.2 Construction note

Rectifiers in I ² PAK & TO-220 packages with new ECOPACK®2 molding compound & electroplating	
Wafer/Die fab. information	
Wafer fab manufacturing location	STMicroelectronics Singapore STMicroelectronics Tours (France) STMicroelectronics Catania (Italy)
Wafer Testing (EWS) information	
Electrical testing manufacturing location	STMicroelectronics Singapore STMicroelectronics Tours (France) STMicroelectronics Catania (Italy)
Assembly information	
Assembly site	STMicroelectronics Shenzhen (China) STMicroelectronics Long Gang (China) STMicroelectronics Bouskoura (Morocco) Subcontractor in Philippines
Package description	I ² PAK / TO-220AB / T O-220AB(NL) / TO-220AC
Molding compound	ECOPACK®2 ("Halogen-free") molding compound
Lead finishing process	Electroplating
Lead finishing material	Tin (Sn 100%)
Final testing information	
Testing location	STMicroelectronics Shenzhen (China) STMicroelectronics Long Gang (China) STMicroelectronics Bouskoura (Morocco) Subcontractor in Philippines

5 TESTS RESULTS SUMMARY

5.1 Test vehicles

Lot #	Product	Back End	Package	Product Family
1	STTH3002CT	ST LGG	TO-220AB	Bipolar Rectifier 200V
2	STTH3012D		TO-220AC	Turboswitch 1200V
3	STTH12R06D			Turboswitch 600V
4	STPS40M60CT		TO-220AB	Power Schottky 60V
5	STPS30M120ST			Power Schottky 120V
6	STPS40SM100CT			Power Schottky 100V
7	STPS2545CTY	ST BSK		Power Schottky 45V
8	STPSC1006D	ST SHZ	TO-220AC	SiC Power Schottky 600V
9	STPS1645D			Power Schottky 45V
10	STPS30M120ST	ST LGG	TO-220AB	Power Schottky 120V
11	STPS40SM100CT	ST SHZ		Power Schottky 100V
12	STPS40SM100CT	ST LGG		Power Schottky 100V
13	STTH1210DY	ST SHZ	TO-220AC	Turboswitch 1200V
14	STPS41L60CT	Subcontractor in Philippines	TO-220AB	Power Schottky 60V

5.2 Test plan and results summary

Die Oriented Tests

Test	PC	Std ref.	Conditions	SS	Steps	Failure/SS					Note
						Lot 1	Lot 3	Lot 6	Lot 7	Lot 8	
HTRB	N	JESD22 A-108	Tj, Vr = 0.8xVrrm	539	168 H	0/77	0/77	0/77	0/77	0/77	
					500 H	0/77	0/77	0/77	0/77	0/77	
					1000 H	0/77	0/77	0/77	0/77	0/77	
					Steps	Failure/SS					Note
						Lot 9	Lot 13				
					168 H	0/77	0/77				
					500 H	0/77	0/77				
					1000 H	0/77	0/77				





Package Oriented Tests

Test	PC	Std ref.	Conditions	SS	Steps	Failure/SS						Note	
						Lot 2	Lot 4	Lot 6	Lot 7	Lot 9	Lot 13		
THB	N	JESD22 A-101	Ta = 85°C, RH = 85%, Vr = 0.8xVrrm or 100V max	306	168 H	0/25	0/25	0/25	0/77	0/77	0/77		
					500 H	0/25	0/25	0/25	0/77	0/77	0/77		
					1000 H	0/25	0/25	0/25	0/77	0/77	0/77		
TC	N	JESD22 A-104	Ta = -55°C to 150°C 1cycle/hour	381	SS	Steps	Failure/SS						Note
							Lot 4	Lot 5	Lot 10	Lot 6	Lot 12	Lot 7	
							100 cy	0/25	0/25	0/25	0/25	0/25	
IOLT	N	MIL-STD 750 Method 1037	IF, delta TC=85°C Power ON=3.5min, Power OFF=3.5min.	127	8572 cycles	Failure/SS						Note	
						Lot 4	Lot 5	Lot 9					
PCT	N	JESD22 A-102	121°C, RH=100%, P=2 bars	306	96hrs	Failure/SS						Note	
						Lot 1	Lot 7	Lot 9	Lot 11	Lot 13	Lot 14		
RSH	N	JESD22 B-106	260°C 10s ON / 15s OFF	60		Failure/SS						Note	
						Lot 6	Lot 7	Lot 9	Lot 11	Lot 14			
Solderability	N	J-STD-002	245°C SnAgCu bath Dry aging	50		Failure/SS						Note	
						Lot 6	Lot 7	Lot 9	Lot 11	Lot 14			
						0/10	0/10	0/10	0/10	0/10			
Solderability	N	J-STD-002	245°C SnAgCu bath Wet aging	50		Failure/SS						Note	
						Lot 6	Lot 7	Lot 9	Lot 11	Lot 14			
						0/10	0/10	0/10	0/10	0/10			
Solderability	N	J-STD-002	220°C SnPb bath Dry aging	50		Failure/SS						Note	
						Lot 6	Lot 7	Lot 9	Lot 11	Lot 14			
						0/10	0/10	0/10	0/10	0/10			
Solderability	N	J-STD-002	220°C SnPb bath Wet aging	50		Failure/SS						Note	
						Lot 6	Lot 7	Lot 9	Lot 11	Lot 14			

6 ANNEXES

6.1 Device details

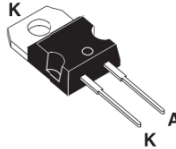
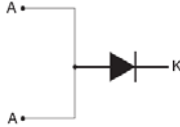
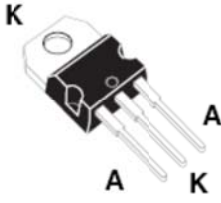
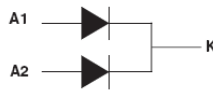
6.1.1 Pin connection

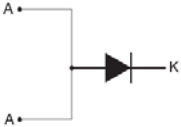
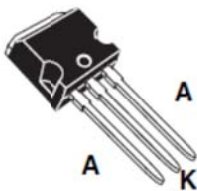
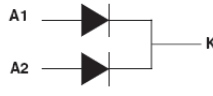
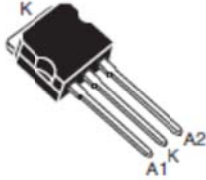
Package	Pin connection
TO-220AC	 
TO-220AB (NL)	<p data-bbox="625 646 1209 678">STPSxxST/STTHxxST: Single diode configuration</p>  
	<p data-bbox="617 930 1218 961">STPSxxCT/STTHxxCT: Double diode configuration</p>  
I ² PAK	<p data-bbox="617 1178 1209 1209">STPSxxSR/STTHxxSR: Single diode configuration</p>  
	<p data-bbox="609 1440 1218 1472">STPSxxCR/STTHxxCR: Double diode configuration</p>  

6.1.2 Package outline/Mechanical data

- TO-220AC

Ref.	Dimensions			
	Millimeters		Inches	
	Min.	Max.	Min.	Max.
A	4.40	4.60	0.173	0.181
C	1.23	1.32	0.048	0.051
D	2.40	2.72	0.094	0.107
E	0.49	0.70	0.019	0.027
F	0.61	0.88	0.024	0.034
F1	1.14	1.70	0.044	0.066
G	4.95	5.15	0.194	0.202
H2	10.00	10.40	0.393	0.409
L2	16.40 typ.		0.645 typ.	
L4	13.00	14.00	0.511	0.551
L5	2.65	2.95	0.104	0.116
L6	15.25	15.75	0.600	0.620
L7	6.20	6.60	0.244	0.259
L9	3.50	3.93	0.137	0.154
M	2.6 typ.		0.102 typ.	
Diam. I	3.75	3.85	0.147	0.151

- TO-220AB

Ref.	Dimensions			
	Millimeters		Inches	
	Min.	Max.	Min.	Max.
A	4.40	4.60	0.173	0.181
C	1.23	1.32	0.048	0.051
D	2.40	2.72	0.094	0.107
E	0.49	0.70	0.019	0.027
F	0.61	0.88	0.024	0.034
F1	1.14	1.70	0.044	0.066
F2	1.14	1.70	0.044	0.066
G	4.95	5.15	0.194	0.202
G1	2.40	2.70	0.094	0.106
H2	10	10.40	0.393	0.409
L2	16.4 typ.		0.645 typ.	
L4	13	14	0.511	0.551
L5	2.65	2.95	0.104	0.116
L6	15.25	15.75	0.600	0.620
L7	6.20	6.60	0.244	0.259
L9	3.50	3.93	0.137	0.154
M	2.6 typ.		0.102 typ.	
Diam.	3.75	3.85	0.147	0.151

• TO-220AB (NL)

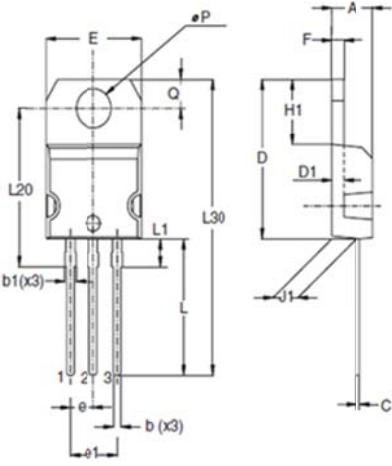

Ref.	Dimensions					
	Millimeters			Inches		
	Min.	Typ.	Max.	Min.	Typ.	Max.
A	4.40		4.60	0.17		0.18
b	0.61		0.88	0.024		0.034
b1	0.95		1.20	0.037		0.047
c	0.48		0.70	0.019		0.027
D	15.25		15.75	0.60		0.62
D1	1.27			0.05		
E	10.00		10.40	0.39		0.41
e	2.40		2.70	0.094		0.106
e1	4.95		5.15	0.19		0.20
F	1.23		1.32	0.048		0.052
H1	6.20		6.60	0.24		0.26
J1	2.40		2.72	0.095		0.107
L	13.00		14.00	0.51		0.55
L1	2.60		2.90	0.102		0.114
L20	15.40			0.61		
L30	28.90			1.14		
ØP	3.75		3.85	0.147		0.151
Q	2.65		2.95	0.104		0.116

• I²PAK

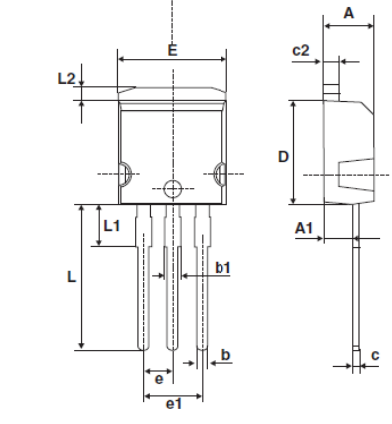

Ref.	Dimensions			
	Millimeters		Inches	
	Min.	Max.	Min.	Max.
A	4.40	4.60	0.173	0.181
A1	2.40	2.72	0.094	0.107
b	0.61	0.88	0.024	0.035
b1	1.14	1.70	0.044	0.067
c	0.49	0.70	0.019	0.028
c2	1.23	1.32	0.048	0.052
D	8.95	9.35	0.352	0.368
e	2.40	2.70	0.094	0.106
e1	4.95	5.15	0.195	0.203
E	10	10.40	0.394	0.409
L	13	14	0.512	0.551
L1	3.50	3.93	0.138	0.155
L2	1.27	1.40	0.050	0.055

6.2 Tests description

Test name	Description	Purpose
Die Oriented		
HTRB High Temperature Reverse Bias HTFB / HTGB High Temperature Forward (Gate) Bias	The device is stressed in static configuration, trying to satisfy as much as possible the following conditions: low power dissipation; max. supply voltage compatible with diffusion process and internal circuitry limitations;	To determine the effects of bias conditions and temperature on solid state devices over time. It simulates the devices' operating condition in an accelerated way. To maximize the electrical field across either reverse-biased junctions or dielectric layers, in order to investigate the failure modes linked to mobile contamination, oxide ageing, layout sensitivity to surface effects.
Package Oriented		
IOLT	All test samples shall be subjected to the specified number of cycles. When stabilized after initial warm-up cycles, a cycle shall consist of an "on" period, when power is applied suddenly, not gradually, to the device for the time necessary to achieve a delta case temperature (delta is the high minus the low mounting surface temperatures) of +85°C (+60°C for thyristors), followed by an off period, when the power is suddenly removed, for cooling the case through a similar delta temperature. Auxiliary (forced) cooling is permitted during the off period only. Heat sinks are not intended to be used in this test, however, small heat sinks may be used when it is otherwise difficult to control case temperature of test samples, such as with small package types (e.g., TO39).	The purpose of this test is to determine compliance with the specified numbers of cycles for devices subjected to the specified conditions. It accelerates the stresses on all bonds and interfaces between the chip and mounting face of devices subjected to repeated turn on and off of equipment and is therefore most appropriate for case mount style (e.g., stud, flange, and disc) devices.
TC Temperature Cycling	The device is submitted to cycled temperature excursions, between a hot and a cold chamber in air atmosphere.	To investigate failure modes related to the thermo-mechanical stress induced by the different thermal expansion of the materials interacting in the die-package system. Typical failure modes are linked to metal displacement, dielectric cracking, molding compound delamination, wire-bonds failure, die-attach layer degradation.
THB Temperature Humidity Bias	The device is biased in static configuration minimizing its internal power dissipation, and stored at controlled conditions of ambient temperature and relative humidity.	To evaluate the package moisture resistance with electrical field applied, both electrolytic and galvanic corrosion are put in evidence.

Test name	Description	Purpose
Package Oriented		
PCT Pressure Pot	The device is stored in saturated steam, at fixed and controlled conditions of pressure and temperature.	To investigate corrosion phenomena affecting die or package materials, related to chemical contamination and package hermeticity.
RSH	The device is submitted to a dipping in a solder bath at 260°C with a dwell time of 10s. Only for through hole mounted devices.	This test is used to determine whether solid state devices can withstand the effects of the temperature to which they will be subjected during soldering of their leads. The heat is conducted through the leads into the device package from solder heat at the reverse side of the board. This procedure does not simulate wave soldering or reflow heat exposure on the same side of the board as the package body.

Please Read Carefully:

Information in this document is provided solely in connection with ST products. STMicroelectronics NV and its subsidiaries ("ST") reserve the right to make changes, corrections, modifications or improvements, to this document, and the products and services described herein at any time, without notice.

All ST products are sold pursuant to ST's terms and conditions of sale.

Purchasers are solely responsible for the choice, selection and use of the ST products and services described herein, and ST assumes no liability whatsoever relating to the choice, selection or use of the ST products and services described herein.

No license, express or implied, by estoppel or otherwise, to any intellectual property rights is granted under this document. If any part of this document refers to any third party products or services it shall not be deemed a license grant by ST for the use of such third party products or services, or any intellectual property contained therein or considered as a warranty covering the use in any manner whatsoever of such third party products or services or any intellectual property contained therein.

UNLESS OTHERWISE SET FORTH IN ST'S TERMS AND CONDITIONS OF SALE ST DISCLAIMS ANY EXPRESS OR IMPLIED WARRANTY WITH RESPECT TO THE USE AND/OR SALE OF ST PRODUCTS INCLUDING WITHOUT LIMITATION IMPLIED WARRANTIES OF MERCHANTABILITY, FITNESS FOR A PARTICULAR PURPOSE (AND THEIR EQUIVALENTS UNDER THE LAWS OF ANY JURISDICTION), OR INFRINGEMENT OF ANY PATENT, COPYRIGHT OR OTHER INTELLECTUAL PROPERTY RIGHT.

UNLESS EXPRESSLY APPROVED IN WRITING BY AN AUTHORIZED ST REPRESENTATIVE, ST PRODUCTS ARE NOT RECOMMENDED, AUTHORIZED OR WARRANTED FOR USE IN MILITARY, AIR CRAFT, SPACE, LIFE SAVING, OR LIFE SUSTAINING APPLICATIONS, NOR IN PRODUCTS OR SYSTEMS WHERE FAILURE OR MALFUNCTION MAY RESULT IN PERSONAL INJURY, DEATH, OR SEVERE PROPERTY OR ENVIRONMENTAL DAMAGE. ST PRODUCTS WHICH ARE NOT SPECIFIED AS "AUTOMOTIVE GRADE" MAY ONLY BE USED IN AUTOMOTIVE APPLICATIONS AT USER'S OWN RISK.

Resale of ST products with provisions different from the statements and/or technical features set forth in this document shall immediately void any warranty granted by ST for the ST product or service described herein and shall not create or extend in any manner whatsoever, any liability of ST.

ST and the ST logo are trademarks or registered trademarks of ST in various countries.

Information in this document supersedes and replaces all information previously supplied.

The ST logo is a registered trademark of STMicroelectronics. All other names are the property of their respective owners

©2012 STMicroelectronics - All rights reserved.

STMicroelectronics group of companies

Australia - Belgium - Brazil - Canada - China - Czech Republic - Finland - France - Germany - Hong Kong - India - Israel - Italy - Japan - Malaysia - Malta - Morocco - Singapore - Spain - Sweden - Switzerland - United Kingdom - United States of America

www.st.com

