



FEATURES

- UL 60950 recognition pending for reinforced insulation
- ANSI/AAMI ES60601-1, 2 MOOPs recognition pending
- 3kVAC isolation test voltage 'Hi Pot Test'
- Continuous short circuit protection
- Output Voltage Trim
- Remote on/off pin
- No electrolytic capacitors
- Operating temperature range -40°C to 100°C
- 2:1 Input Range

PRODUCT OVERVIEW

The MTC1 series of miniature surface mount DC/DC converters offers a single output voltage from input voltage ranges of 4.5-18V and 9-36V. The MTC1 series regulated output voltage is adjustable by $\pm 10\%$ and a remote on/off pin is also included for application power saving.

The MTC1 ideally suited to applications which include medical. Industrial, telecommunications, battery powered systems, and process automation.

SELECTION GUIDE

| Order Code ¹ | Input Voltage | Output Voltage | Output Current | Rated Input Current | Efficiency | | Ripple and Noise | | MTTF ² | |
|-------------------------|---------------|----------------|----------------|---------------------|------------|-----------|------------------|---------------|-------------------|--------------------|
| | Nom. V | V | mA | mA | Min. % | Typ. % | Typ. mVp/p | Max. mVp/p | MIL kHrs | Telecordia kHrs |
| MTC1S1203MC | 12 | 3.3 | 303 | 110 | 72 | 75 | 25 | 50 | 1143 | 17407 |
| MTC1S1205MC | 12 | 5 | 200 | 110 | 77 | 78.5 | 25 | 50 | 1129 | 17407 |
| MTC1S1212MC | 12 | 12 | 83 | 100 | 77 | 79 | 20 | 40 | 977 | 17407 |
| MTC1S2403MC | 24 | 3.3 | 303 | 55 | 73 | 75.5 | 30 | 55 | 1042 | 17109 |
| MTC1S2405MC | 24 | 5 | 200 | 55 | 74 | 76.5 | 25 | 50 | 990 | 17109 |
| MTC1S2412MC | 24 | 12 | 83 | 55 | 75 | 77 | 25 | 50 | 833 | 17109 |

INPUT CHARACTERISTICS

| Parameter | Conditions | Min. | Typ. | Max. | Units |
|--------------------------------|-----------------|------|------|------|--------|
| Voltage range | 12V input types | 9 | 12 | 18 | V |
| | 24V input types | 18 | 24 | 36 | |
| Input reflected ripple current | All variants | | 2 | | mA p-p |

OUTPUT CHARACTERISTICS

| Parameter | Conditions | Min. | Typ. | Max. | Units |
|--|---|--------------------|------------|-----------|-------------------|
| Rated power | All output types | | | 1 | W |
| Minimal load to meet datasheet specification | | 10 | | | % |
| Voltage set point accuracy | 3V, 5V output types | -2.5 | | 2 | % |
| | 12V output types | -3 | | 2 | |
| Line regulation | Low line to high line | | ± 0.05 | ± 0.2 | % |
| Load regulation | All output types | | ± 0.25 | ± 0.5 | % |
| Transient response | Peak deviation (25-75% & 75-25% swing) | 2403 variant | | ± 4 | %V _{out} |
| | | 2405 variant | | ± 3 | |
| | | All other variants | | ± 2 | |
| | Settling time (within 5% V _{out} Nom.) | 1203 | | 220 | μ s |
| | | 1205 | | 260 | |
| | 1212, 2403 & 2405 | | 100 | | |
| | 2412 | | 70 | | |

ISOLATION CHARACTERISTICS

| Parameter | Conditions | Min. | Typ. | Max. | Units |
|------------------------|---------------------------|------|------|------|------------|
| Isolation test voltage | Flash tested for 1 second | 3000 | | | VAC |
| Isolation capacitance | All variants | | 7 | | pF |
| Resistance | Viso = 1kVDC | 1 | | | G Ω |



1. Components are supplied in tape and reel packaging, please refer to package specification section. Orderable part numbers are MTC1SXXXXMC-R7 (30 pieces per reel), or MTC1SXXXXMC-R13 (150 pieces per reel)
 2. Calculated using MIL-HDBK-217 FN2 and Telecordia SR-332 calculation model with nominal input voltage at full load.

All specifications typical at T_a=25°C, nominal input voltage and rated output current unless otherwise specified.

GENERAL CHARACTERISTICS¹

| Parameter | Conditions | Min. | Typ. | Max. | Units |
|---------------------|---|------|------|------|-------|
| Switching frequency | 1203, 2405, 2403 variants | | 240 | | kHz |
| | 1205, 2412 variants | | 260 | | |
| | 1212 variant | | 300 | | |
| Remote on/off pin | Module on, pin unconnected or open collector floating | | | | |
| | Module off (refer to application notes) | | 2 | | V |
| | 12V input types | | 1.5 | | mW |
| | 24V input types | | 3.9 | | |

TEMPERATURE CHARACTERISTICS

| Parameter | Conditions | Min. | Typ. | Max. | Units |
|--------------------------------|--|------|------|------|-------|
| Operation | | -40 | | 100 | °C |
| Storage | | -50 | | 125 | |
| Case temperature above ambient | 100% Load, Nom V _{IN} , Still Air | | 15 | | |

ABSOLUTE MAXIMUM RATINGS

| | |
|--|------------|
| Short-circuit protection (for SELV input voltages) | Continuous |
| Remote on/off pin input voltage | 6V |
| Input voltage, MTC1 12V input types | 25V |
| Input voltage, MTC1 24V input types | 40V |

APPLICATION NOTES

Maximum Output Capacitance

Maximum output capacitance should not exceed:

| Output Voltage | Maximum Load Capacitance |
|----------------|--------------------------|
| V | µF |
| 3.3 | 470 |
| 5 | 470 |
| 12 | 220 |

Start-up times

Typical start up times for this series, with a typical input voltage rise time of 2.2µs and output capacitance of 10µF, are shown in the table below. The product series will start into the maximum output capacitance with increased start times.

| Part No. | Start-up times |
|--------------------|----------------|
| | ms |
| MTC1S1203SC | 5 |
| MTC1S1205SC | 14 |
| MTC1S1212SC | 25 |
| MTC1S2403SC | 9 |
| MTC1S2405SC | 14 |
| MTC1S2412SC | 25 |

Typical Wave Form:

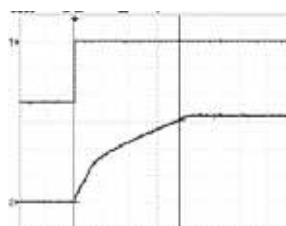

APPLICATION NOTES

Control Pin

The MTC1 converters have a shutdown feature which enables the user to put the converter into a low power state. The control pin connects directly to the base of an internal transistor, and the switch off mechanism for the MTC1 works by forward biasing this NPN transistor. If the pin is left open (high impedance), the converter will be ON (there is no allowed low state for this pin), but once a control voltage is applied with sufficient drive current, the converter will be switched OFF. A suitable application circuit is shown below.

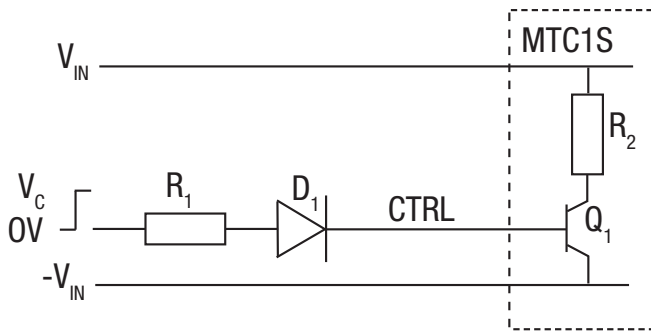

D₁ (e.g. 1N4001) is required to provide high impedance when the signal is low. From the MTC1 specification, the drive current to operate this function is recommended to be 3mA to 8mA, and hence the value of R₁ can be derived as follows:

$$R_1 = \frac{V_C - V_D - 0.6}{I_B}$$

Assuming V_C=5V, V_D=0.7V:

$$R_1 = \frac{5 - 0.7 - 0.6}{5 \times 10^{-3}} = 732\Omega \text{ (E96, 1\% resistor)}$$

For 5V TTL signal:
Set R₁ to be 82Ω or less

Output Voltage Adjustment

The MTC1S series has a trim capability which is located at pin 3, this allows the user to independently adjust the output voltages by ±10%. Adjustments to the output voltages can be accomplished via a single fixed resistor as shown in Figures 1 and 2. A single fixed resistor can increase or decrease the output voltage depending on its connection. Fixed resistors should have low temperature coefficient to minimize sensitivity to changes in temperature.

A single resistor connected from the TRIM pin (pin 3) to the +V_{out} (pin 4), will decrease the output voltage which is shown in figure 1.

A single resistor connected from the TRIM pin (pin 3) to the -V_{out} (pin 2) will increase the output voltage which is shown in figure 2.

TRIM DOWN

Figure 1. Trim connections to decrease the output voltage

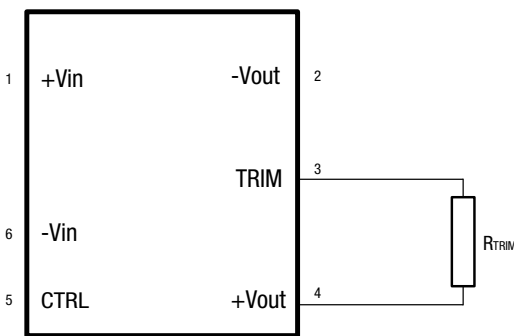

$$3.3V_{out} R_{TRIM} = \frac{18.64k \times V_{out} - 52.3k}{3.32 - V_{out}}$$

$$5V_{out} R_{TRIM} = \frac{33.2k \times V_{out} - 141k}{5 - V_{out}}$$

$$12V_{out} R_{TRIM} = \frac{12.5k \times V_{out} - 171.29k}{11.979 - V_{out}}$$

TRIM UP

Figure 2. Trim connections to increase the output voltage

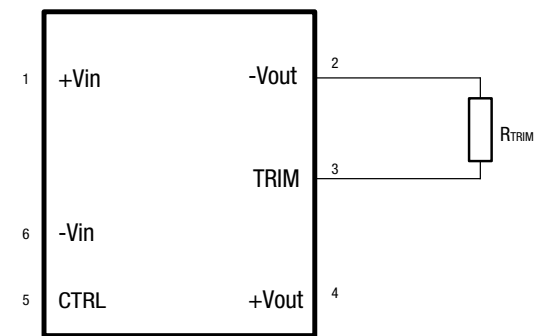

$$3.3V_{out} R_{TRIM} = \frac{14k \times V_{out} - 52.3k}{3.32 - V_{out}}$$

$$5V_{out} R_{TRIM} = \frac{23.2k \times V_{out} - 141k}{5 - V_{out}}$$

$$12V_{out} R_{TRIM} = \frac{12.4k \times V_{out} - 171.29k}{11.979 - V_{out}}$$

Accuracy of adjustment is subject to tolerances of resistors and factory adjusted output accuracy. V_{out} is equal to the desired output voltage.

TECHNICAL NOTES

ISOLATION VOLTAGE

‘Hi Pot Test’, ‘Flash Tested’, ‘Withstand Voltage’, ‘Proof Voltage’, ‘Dielectric Withstand Voltage’ & ‘Isolation Test Voltage’ are all terms that relate to the same thing, a test voltage, applied for a specified time, across a component designed to provide electrical isolation, to verify the integrity of that isolation.

Murata Power Solutions MTC1 series of DC/DC converters are all 100% production tested at their stated isolation voltage. This is 3kVRMS for 1 second.

A question commonly asked is, “What is the continuous voltage that can be applied across the part in normal operation?”

The MTC1 series is pending recognition by Underwriters Laboratory to 250Vrms for Reinforced Insulation.

REPEATED HIGH-VOLTAGE ISOLATION TESTING

It is well known that repeated high-voltage isolation testing of a barrier component can actually degrade isolation capability, to a lesser or greater degree depending on materials, construction and environment. We therefore strongly advise against repeated high voltage isolation testing, but if it is absolutely required, that the voltage be reduced by 20% from specified test voltage.

SAFETY APPROVAL

ANSI/AAMI ES60601-1

The MTC1 series is pending recognition by Underwriters Laboratory (UL) to ANSI/AAMI ES60601-1 and provides 2 MOOP (Means Of Operator Protection) based upon a working voltage of ??? Vrms max., between Primary and Secondary.

UL 60950

The MTC1 series is pending recognition by Underwriters Laboratory (UL) to UL 60950 for reinforced insulation to a working voltage of 250Vrms.

FUSING

The MTC1 Series of converters are not internally fused so to meet the requirements of UL an anti-surge input line fuse should always be used with ratings as defined below.

Input Voltage, 12V: 0.5A

Input Voltage, 24V: 0.25A

All fuses should be UL recognized and rated to at least the maximum allowable DC input voltage.

RoHS COMPLIANCE INFORMATION, MSL



This series is compatible with RoHS soldering systems with a peak reflow solder temperature of 245°C as per J-STD-020D.1. The pin termination finish on this product series is Gold with Nickel Pre-plate. The series is backward compatible with Sn/Pb soldering systems. The series has a Moisture Sensitivity Level (MSL) 1.

CHARACTERISATION TEST METHODS

Ripple & Noise Characterisation Method

Ripple and noise measurements are performed with the following test configuration.

| | |
|-------|--|
| C1 | 1µF X7R multilayer ceramic capacitor, voltage rating to be a minimum of 3 times the output voltage of the DC/DC converter |
| C2 | 10µF tantalum capacitor, voltage rating to be a minimum of 1.5 times the output voltage of the DC/DC converter with an ESR of less than 100mΩ at 100 kHz |
| C3 | 100nF multilayer ceramic capacitor, general purpose |
| R1 | 450Ω resistor, carbon film, ±1% tolerance |
| R2 | 50Ω BNC termination |
| T1 | 3T of the coax cable through a ferrite toroid |
| RLOAD | Resistive load to the maximum power rating of the DC/DC converter. Connections should be made via twisted wires |

Measured values are multiplied by 10 to obtain the specified values.

Differential Mode Noise Test Schematic

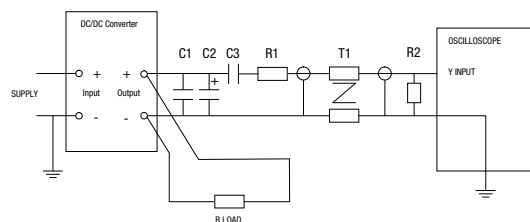

EFFICIENCY VS LOAD

MTC1S1203SC

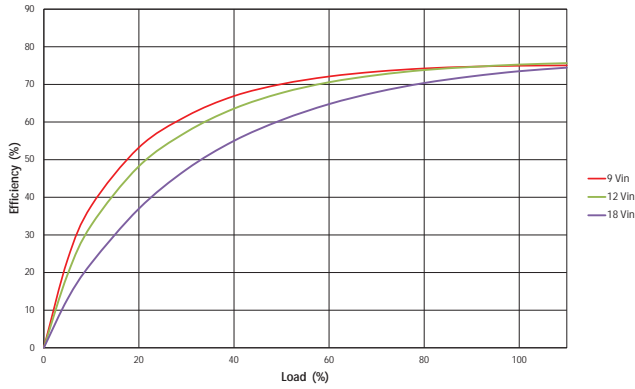

MTC1S1205SC

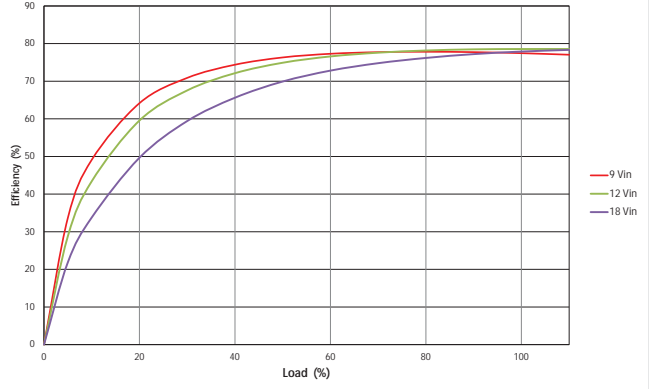

MTC1S1212SC

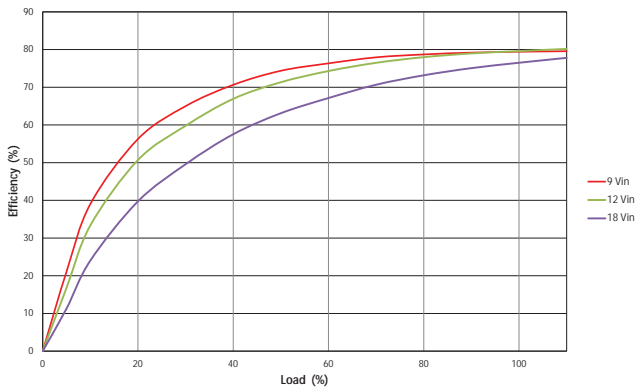

MTC1S2403SC

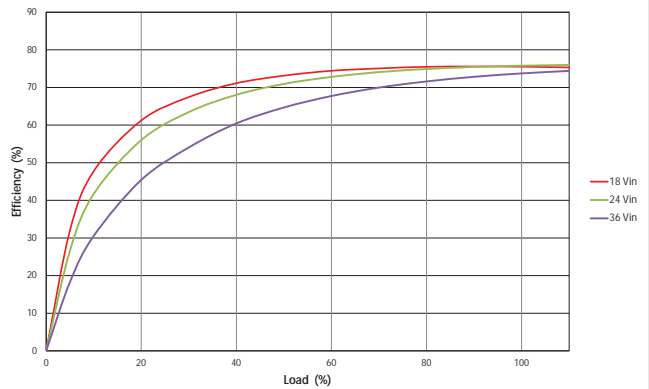

MTC1S2405SC

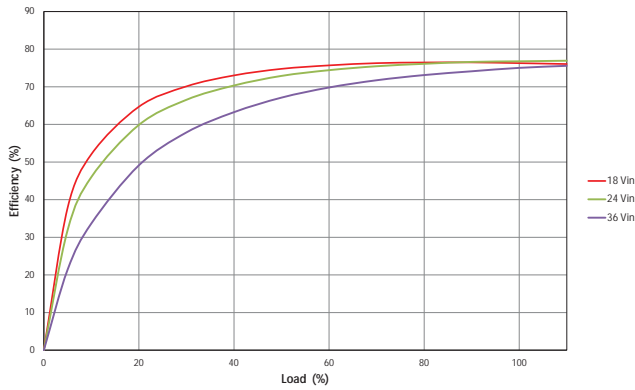

MTC1S2412SC

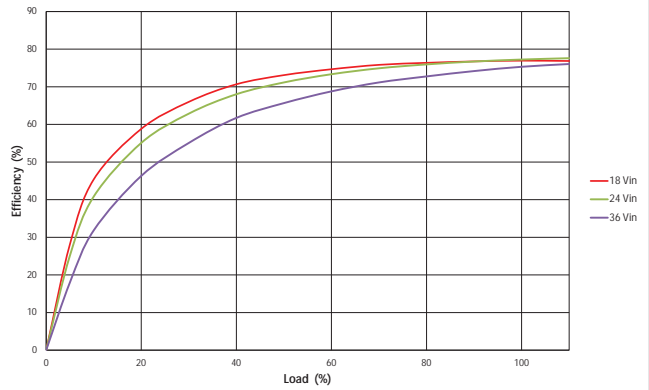

DERATING GRAPHS

MTC1S1203SC - 12Vin

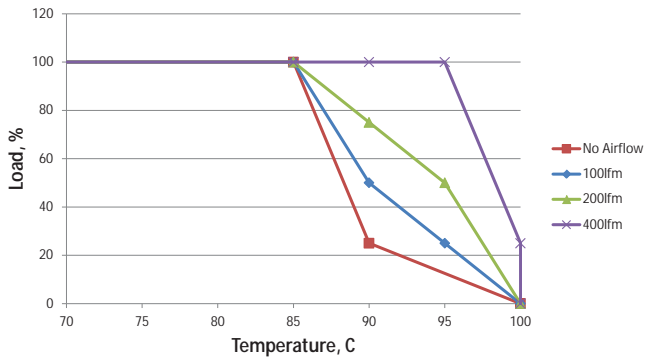

MTC1S1205SC - 12Vin

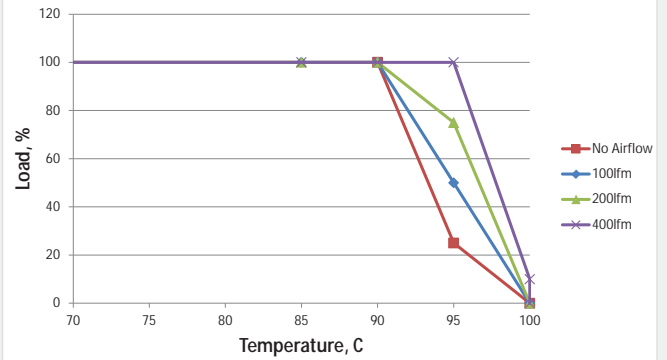

MTC1S1212SC - 12Vin

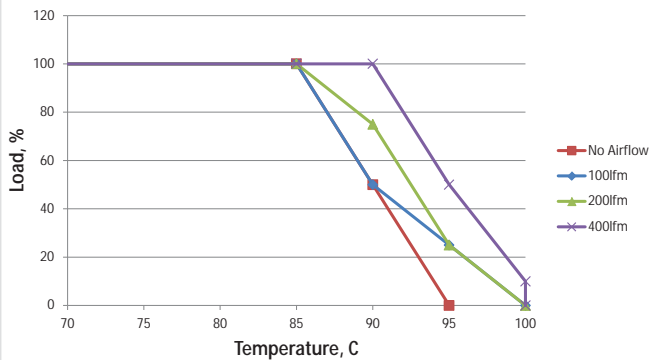

MTC1S2403SC - 24Vin

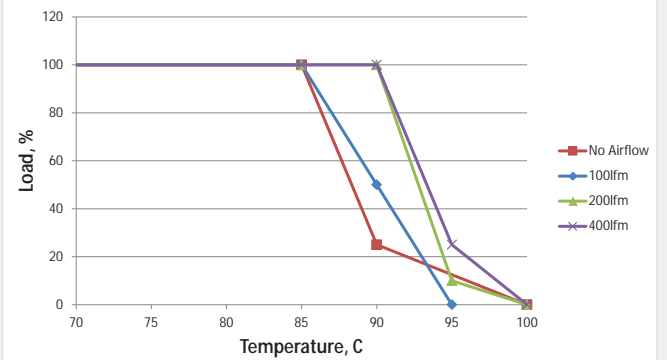

MTC1S2405SC - 24Vin

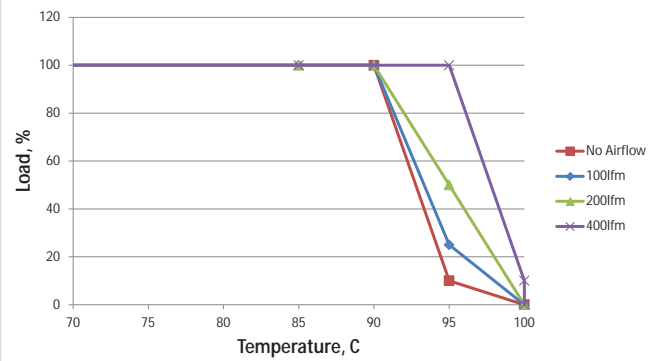

MTC1S2412SC - 24Vin

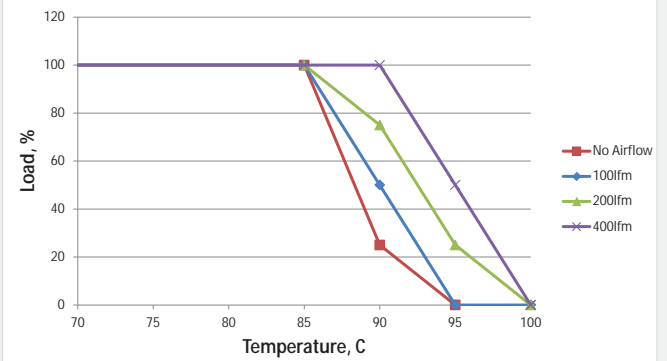

DERATING GRAPHS

MTC1S1203SC - 9Vin

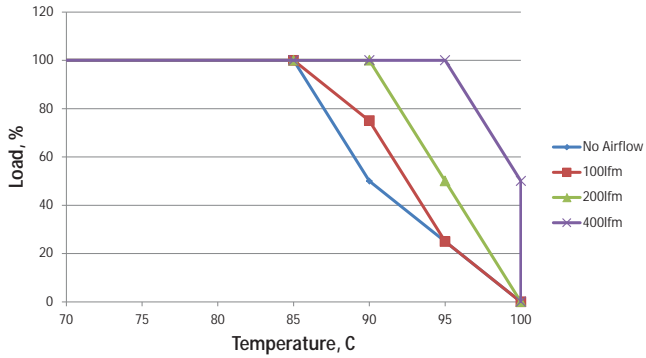

MTC1S1205SC - 9Vin

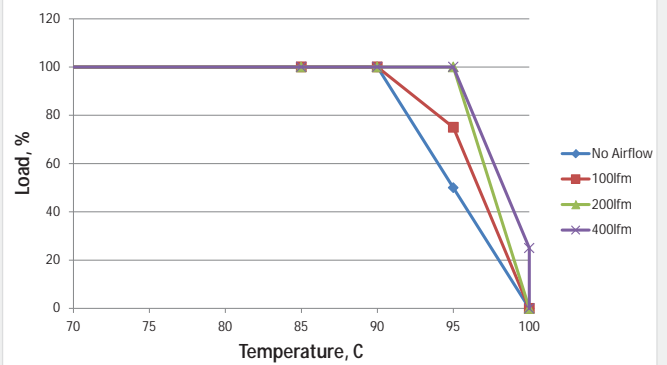

MTC1S1212SC - 9Vin

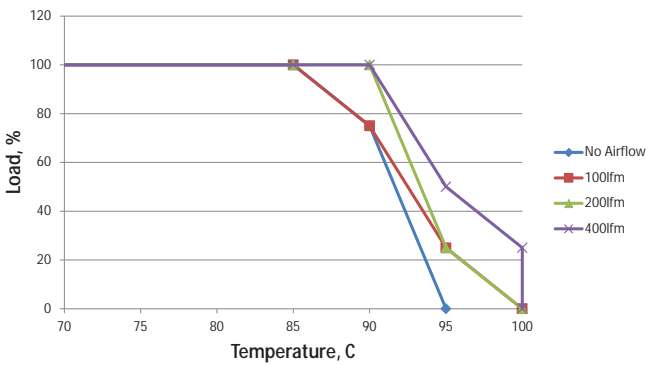

MTC1S2403SC - 18Vin

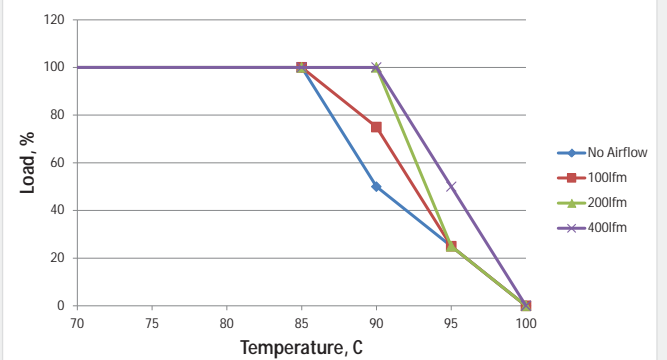

MTC1S2405SC - 18Vin

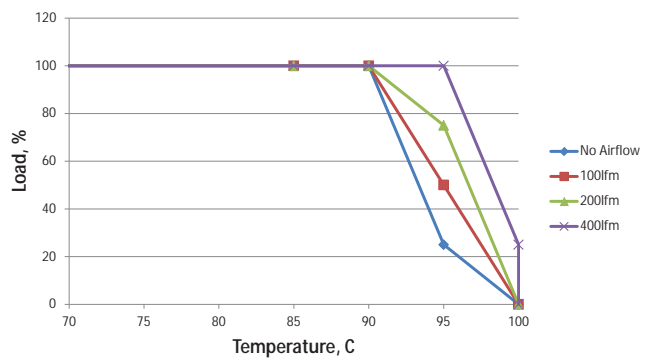

MTC1S2412SC - 18Vin

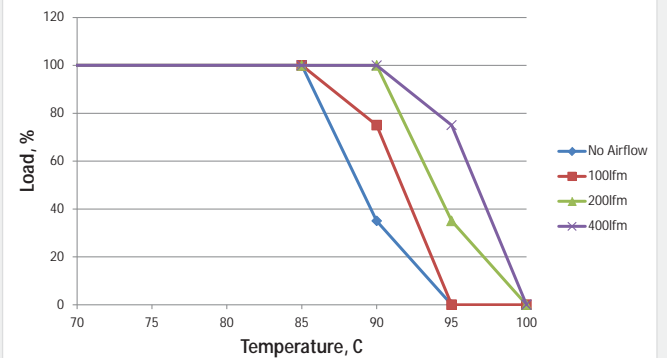

DERATING GRAPHS

MTC1S1203SC - 18Vin

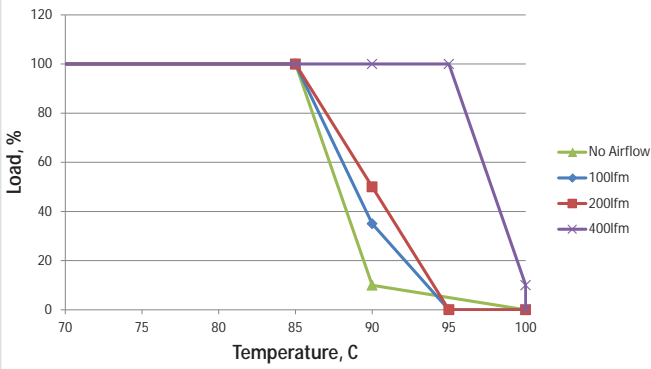

MTC1S1205SC - 18Vin

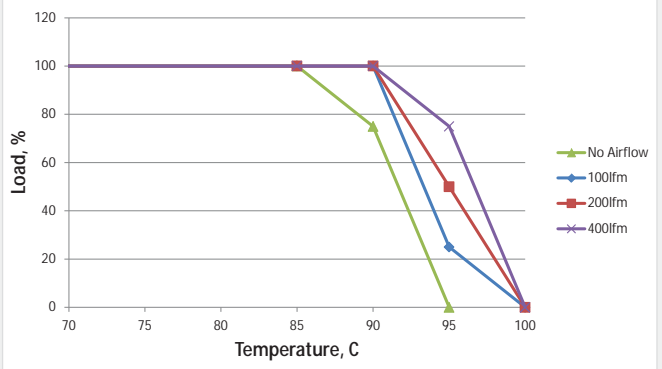

MTC1S1212SC - 18Vin

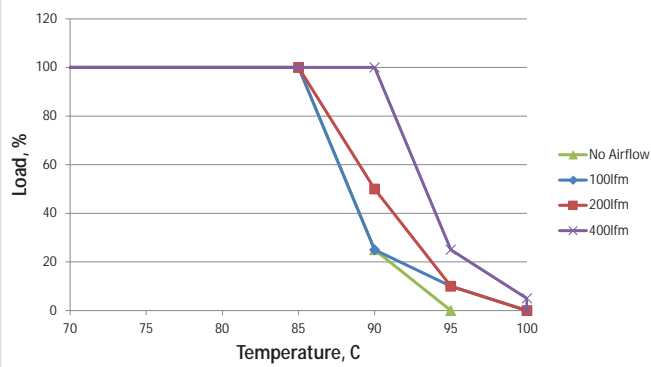

MTC1S2403SC - 36Vin

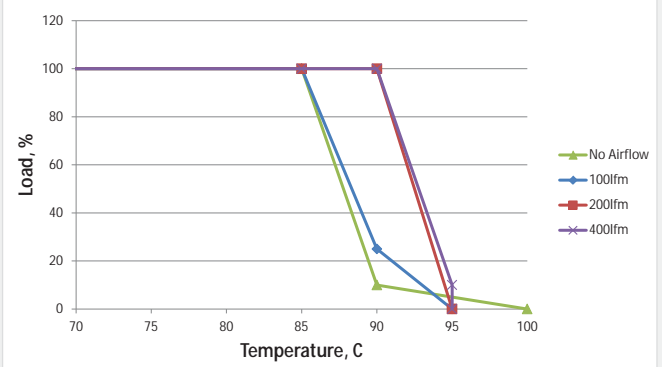

MTC1S2405SC - 36Vin

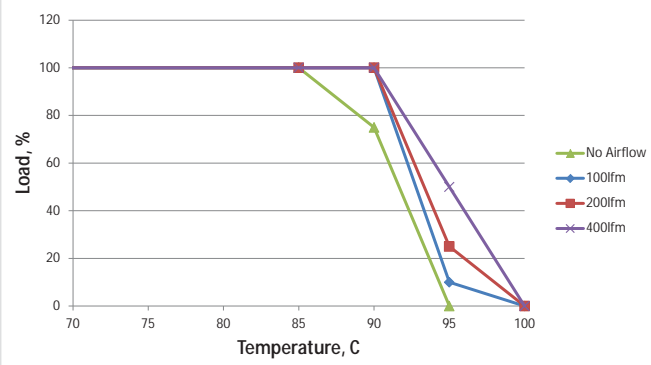

MTC1S2412SC - 36Vin

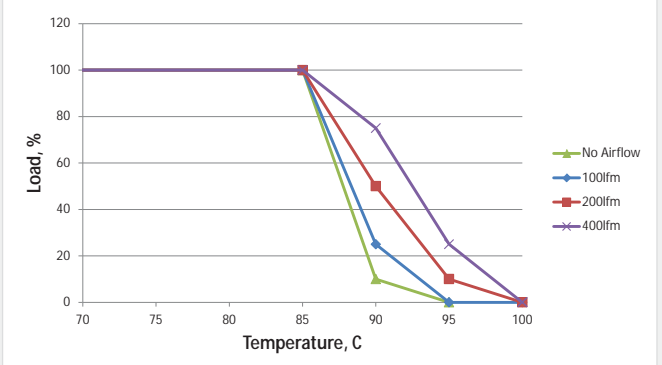

EMC FILTERING AND SPECTRA

FILTERING

The module includes a basic level of filtering. With the addition of an input capacitor of 680nF and input inductor 10µH that are typically required to meet EN 55022 Curve A Quasi-Peak EMC limit, as shown in the following plots.

MTC1S1203SC

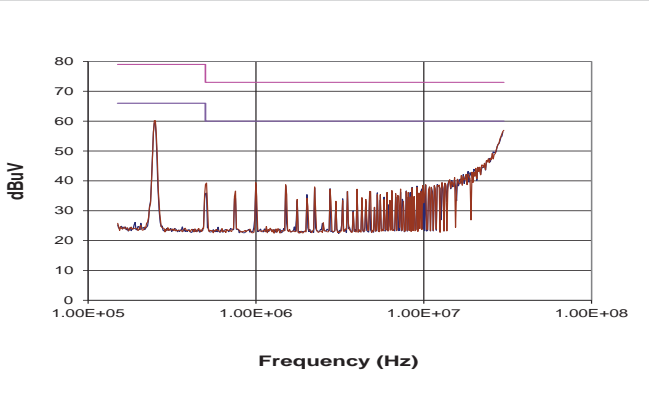

MTC1S1205SC

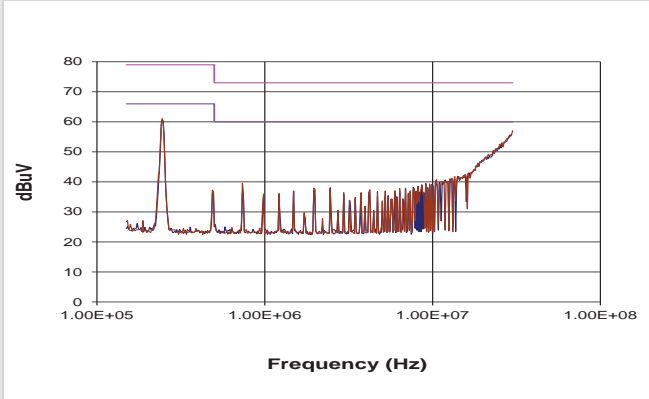

MTC1S1212SC

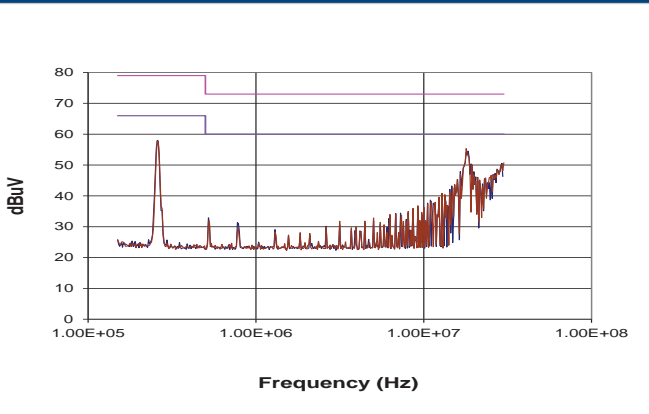

MTC1S2403SC

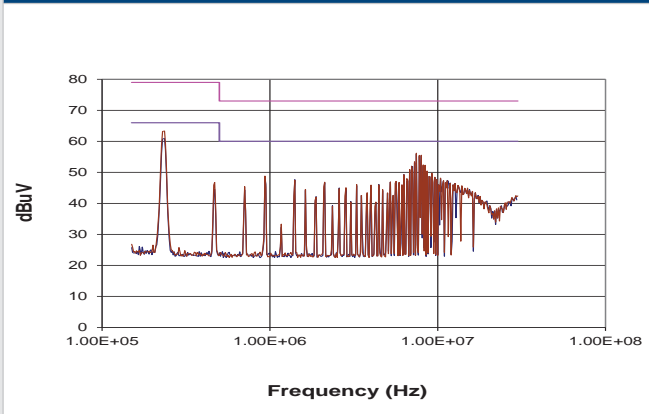

MTC1S2405SC

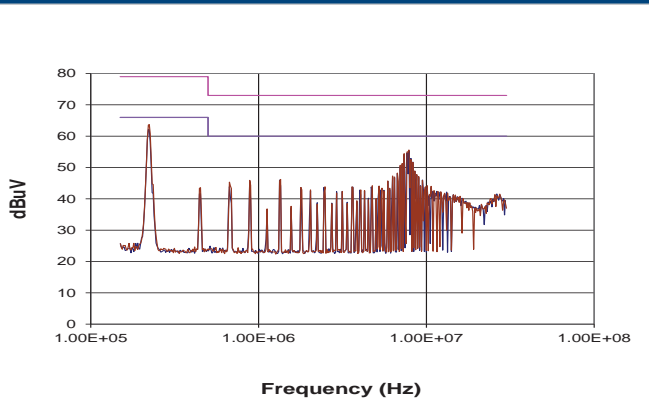

MTC1S2412SC

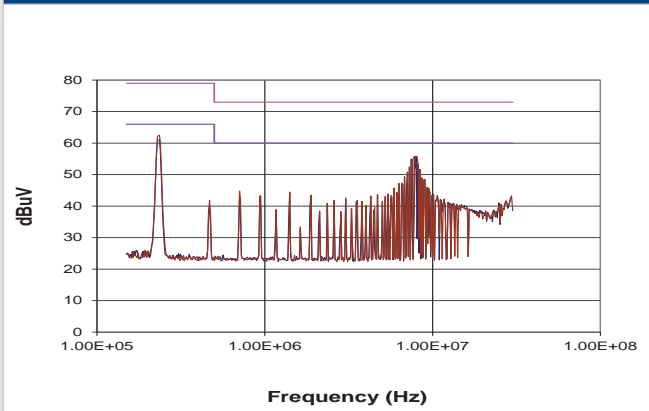

PACKAGE SPECIFICATIONS

Mechanical Dimensions

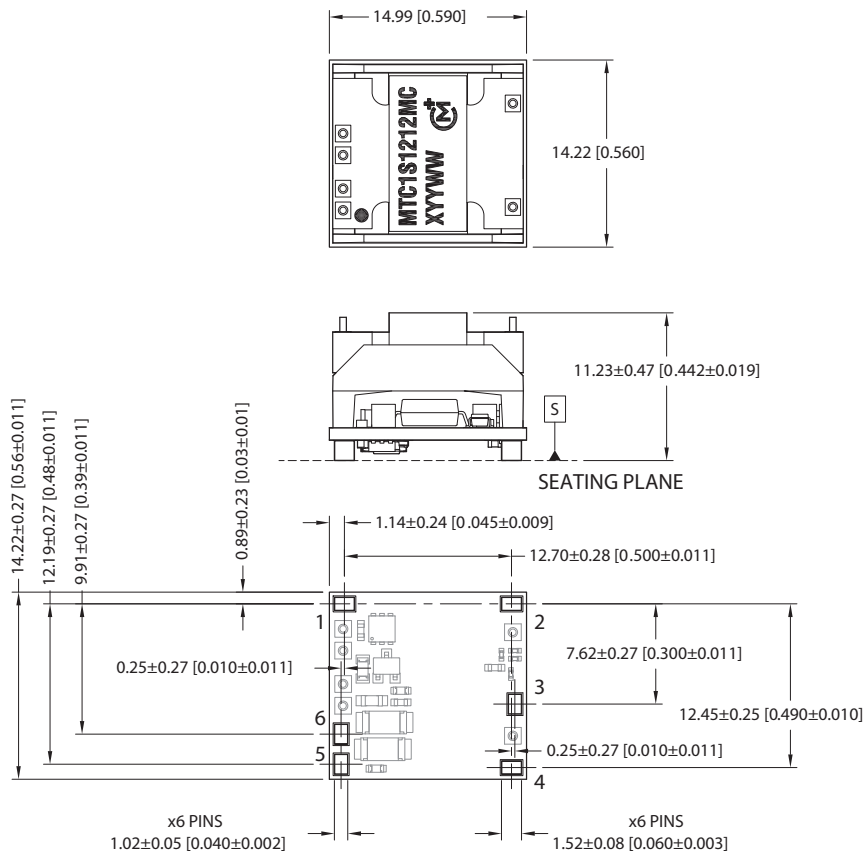

All dimensions in mm(inches). Controlling dimension is mm. Tolerances (unless otherwise stated) ±0.10(0.004).

Weight: 3.4g

Pin Connections

| Pin | Function |
|-----|----------|
| 1 | +Vin |
| 2 | -Vout |
| 3 | Trim |
| 4 | +Vout |
| 5 | Ctrl |
| 6 | -Vin |

Recommended Footprint Details

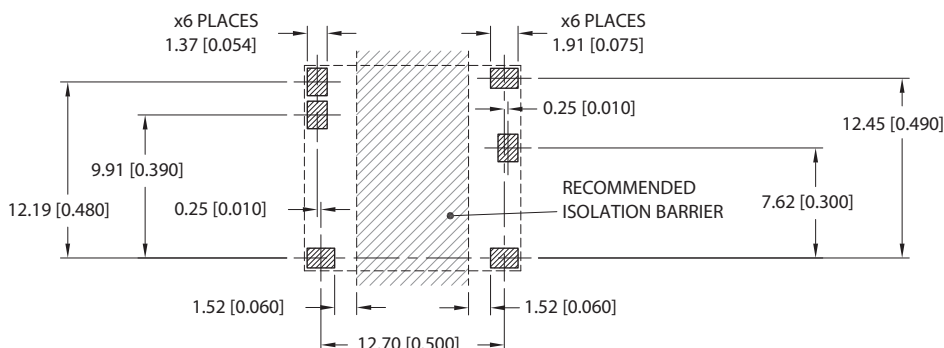

TAPE & REEL SPECIFICATIONS

REEL OUTLINE DIMENSIONS

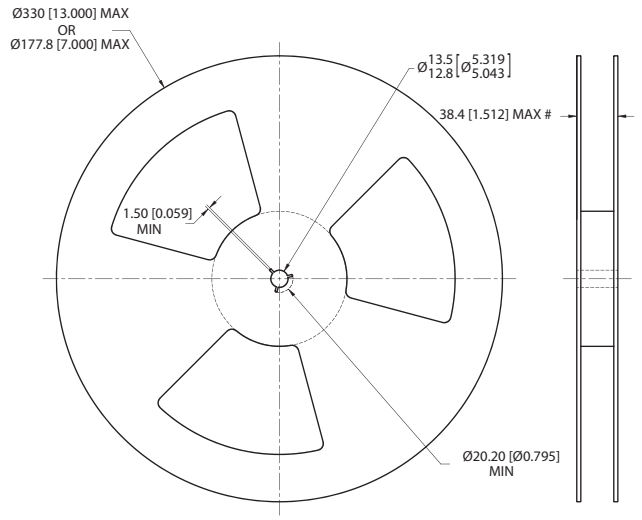

Tape & Reel specifications shall conform with current EIA-481 standard
 Unless otherwise stated all dimensions in mm(inches)
 Controlling dimension is mm
 # Measured at hub

REEL PACKAGING DETAILS

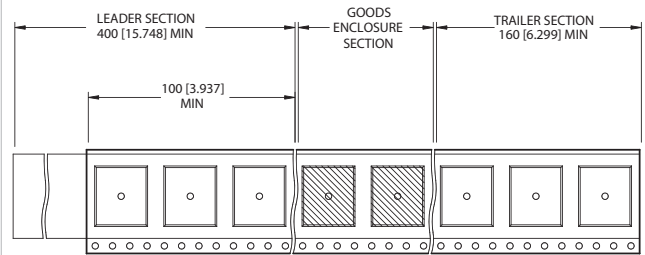

Carrier tape pockets shown are illustrative only - Refer to carrier tape diagram for actual pocket details.
 Reel Quantity: 7" - 30 or 13" - 150

TAPE OUTLINE DIMENSIONS

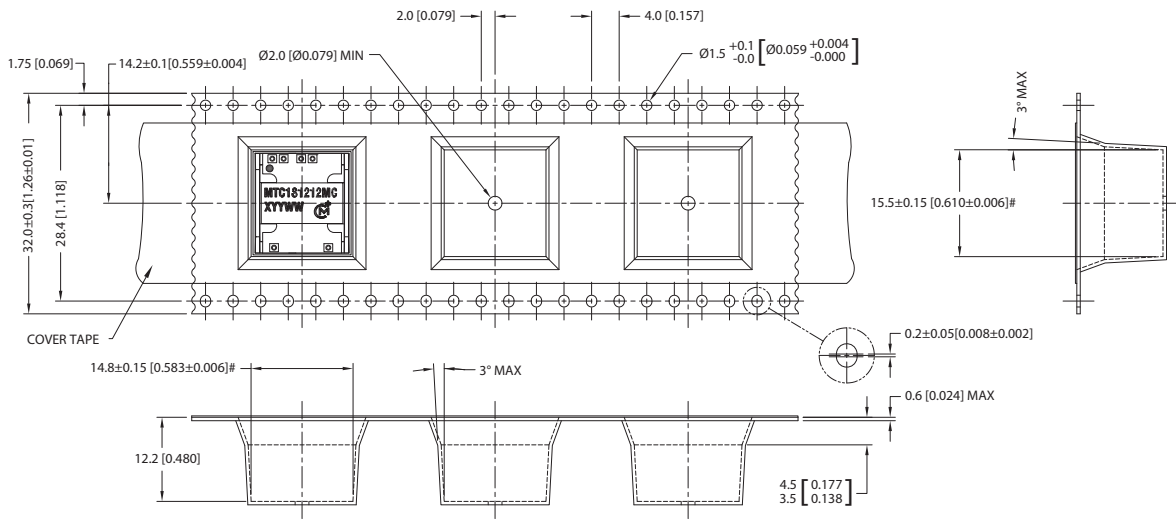

Tape & Reel specifications shall conform with current EIA-481 standard
 Unless otherwise stated all dimensions in mm(inches) ±0.1mm (±0.004 inches)
 Controlling dimension is mm
 Components shall be orientated within the carrier tape as indicated
 # Measured on a plane 0.3mm above the bottom pocket

Murata Power Solutions, Inc.
 11 Cabot Boulevard, Mansfield, MA 02048-1151 U.S.A.
 ISO 9001 and 14001 REGISTERED

This product is subject to the following operating requirements and the Life and Safety Critical Application Sales Policy:
 Refer to: <http://www.murata-ps.com/requirements/>

Murata Power Solutions, Inc. makes no representation that the use of its products in the circuits described herein, or the use of other technical information contained herein, will not infringe upon existing or future patent rights. The descriptions contained herein do not imply the granting of licenses to make, use, or sell equipment constructed in accordance therewith. Specifications are subject to change without notice.
 © 2015 Murata Power Solutions, Inc.