



November 2014

SMBJ5V0(C)A - SMBJ170(C)A 600 Watt Transient Voltage Suppressors

Features

- Glass-Passivated Junction
- 600 W Peak Pulse Power Capability on 10/1000 μ s Waveform.
- Excellent Clamping Capability
- Low-Incremental Surge Resistance
- Fast Response Time: Typically Less than 1.0 ps from 0 V to BV minimum for Unidirectional and 5.0 ns for Bidirectional
- Typical I_R Less than 1.0 μ A Above 10 V
- UL Certificate #E258596

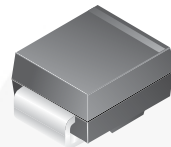

SMB/DO-214AA

Band denotes cathode on unidirectional devices only. No band on bi-directional devices. Bi-directional types have CA suffix where electrical characteristics apply in both directions suitable for bi-directional applications.

Absolute Maximum Ratings

Stresses exceeding the absolute maximum ratings may damage the device. The device may not function or be operable above the recommended operating conditions and stressing the parts to these levels is not recommended. In addition, extended exposure to stresses above the recommended operating conditions may affect device reliability. The absolute maximum ratings are stress ratings only. Values are at $T_A = 25^\circ\text{C}$ unless otherwise noted.

Symbol	Parameter	Value	Unit
P_{PPM}	Peak Pulse Power Dissipation on 10/1000 μ s Waveform	600	W
I_{PPM}	Peak Pulse Current on 10/1000 μ s Waveform	See Table	A
I_{FSM}	Non-Repetitive Peak Forward Surge Current Superimposed on Rated Load (JEDEC Method) ⁽¹⁾	100	A
T_{STG}	Storage Temperature Range	-55 to 150	$^\circ\text{C}$
T_J	Operating Junction Temperature Range	-55 to 150	$^\circ\text{C}$

Note:

1. Measured on 8.3 ms single half-sine wave or equivalent square wave: duty cycle = 4 pulses per minute maximum.

SMBJ5V0(C)A - SMBJ170(C)A — 600 Watt Transient Voltage Suppressors

Electrical Characteristics

Values are at $T_A = 25^\circ\text{C}$ unless otherwise noted.

Uni-Directional Bi-Directional (C) Device	Part Marking ⁽²⁾	Reverse Stand-Off Voltage V_{RWM} (V)	Breakdown Voltage V_{BR} (V)		Test Current I_T (mA)	Clamping Voltage at I_{PPM} V_C (V)	Peak Pulse Current I_{PPM} (A)	Reverse Leakage at V_{RWM} I_R (μA) ⁽³⁾
			Min.	Max.				
SMBJ5V0(C)A	KE	5.0	6.40	7.00	10	9.2	65.2	800
SMBJ6V0(C)A	KG	6.0	6.67	7.37	10	10.3	58.3	800
SMBJ6V5(C)A	KK	6.5	7.22	7.98	10	11.2	53.6	500
SMBJ7V0(C)A	KM	7.0	7.78	8.60	10	12.0	50.0	200
SMBJ7V5(C)A	KP	7.5	8.33	9.21	1	12.9	46.5	100
SMBJ8V0(C)A	KR	8.0	8.89	9.83	1	13.6	44.1	50
SMBJ8V5(C)A	KT	8.5	9.44	10.4	1	14.4	41.7	20
SMBJ9V0(C)A	KV	9.0	10.0	11.1	1	15.4	39.0	10
SMBJ10(C)A	KX	10	11.1	12.8	1	17.0	35.3	5
SMBJ11(C)A	KZ	11	12.2	13.5	1	18.2	33.0	5
SMBJ12(C)A	LE	12	13.3	14.7	1	19.9	30.2	5
SMBJ13(C)A	LG	13	14.4	15.9	1	21.5	27.9	5
SMBJ14(C)A	LK	14	15.6	17.2	1	23.2	25.9	5
SMBJ15(C)A	LM	15	16.7	18.5	1	24.4	24.6	5
SMBJ16(C)A	LP	16	17.8	19.7	1	26.0	23.1	5
SMBJ17(C)A	LR	17	18.9	20.9	1	27.6	21.7	5
SMBJ18(C)A	LT	18	20.0	22.1	1	29.2	20.5	5
SMBJ20(C)A	LV	20	22.2	24.5	1	32.4	18.5	5
SMBJ22(C)A	LX	22	24.4	26.9	1	35.5	16.9	5
SMBJ24(C)A	LZ	24	26.7	29.5	1	38.9	15.4	5
SMBJ26(C)A	ME	26	28.9	31.9	1	42.1	14.3	5
SMBJ28(C)A	MG	28	31.1	34.4	1	45.4	13.2	5
SMBJ30(C)A	MK	30	33.3	36.8	1	48.4	12.4	5
SMBJ33(C)A	MM	33	36.7	40.6	1	53.3	11.3	5
SMBJ36(C)A	MP	36	40.0	44.2	1	58.1	10.3	5
SMBJ40(C)A	MR	40	44.4	49.1	1	64.5	9.3	5
SMBJ43(C)A	MT	43	47.8	52.8	1	69.4	8.6	5
SMBJ45(C)A	MV	45	50.0	55.3	1	72.7	8.3	5
SMBJ48(C)A	MX	48	53.3	58.9	1	77.4	7.8	5
SMBJ51(C)A	MZ	51	56.7	62.7	1	82.4	7.3	5
SMBJ54(C)A	NE	54	60.0	66.3	1	87.1	6.9	5
SMBJ58(C)A	NG	58	64.4	71.2	1	93.6	6.4	5
SMBJ60(C)A	NK	60	66.7	73.7	1	96.8	6.2	5
SMBJ64(C)A	NM	64	71.1	78.6	1	103.0	5.8	5
SMBJ70(C)A	NP	70	77.8	86.0	1	113.0	5.3	5
SMBJ75(C)A	NR	75	83.3	92.1	1	121.0	5.0	5
SMBJ78(C)A	NT	78	86.7	95.8	1	126.0	4.8	5

Notes:

2. Color band denotes cathode on unidirectional devices only. No color band on bidirectional devices.
3. For bidirectional parts with $V_{RWM} < 10$ V, the I_R max limit is doubled.

Electrical Characteristics (Continued)Values are at $T_A = 25^\circ\text{C}$ unless otherwise noted.

Uni-Directional Bi-Directional (C) Device	Part Marking ⁽²⁾	Reverse Stand-Off Voltage V_{RWM} (V)	Breakdown Voltage V_{BR} (V)		Test Current I_T (mA)	Clamping Voltage at I_{PPM} V_C (V)	Peak Pulse Current I_{PPM} (A)	Reverse Leakage at V_{RWM} I_R (μA) ⁽³⁾
			Min.	Max.				
SMBJ85(C)A	NV	85	94.4	104.0	1	137.0	4.4	5
SMBJ90(C)A	NX	90	100.0	111.0	1	146.0	4.1	5
SMBJ100(C)A	NZ	100	111.0	123.0	1	162.0	3.7	5
SMBJ110(C)A	PE	110	122.0	135.0	1	177.0	3.4	5
SMBJ120(C)A	PG	120	133.0	147.0	1	193.0	3.1	5
SMBJ130(C)A	PK	130	144.0	159.0	1	209.0	2.9	5
SMBJ150(C)A	PM	150	167.0	185.0	1	243.0	2.5	5
SMBJ160(C)A	PP	160	178.0	197.0	1	259.0	2.3	5
SMBJ170(C)A	PR	170	189.0	209.0	1	275.0	2.2	5

Notes:

- Color band denotes cathode on unidirectional devices only. No color band on bidirectional devices.
- For bidirectional parts with $V_{RWM} < 10$ V, the I_R max limit is doubled.

Typical Performance Characteristics

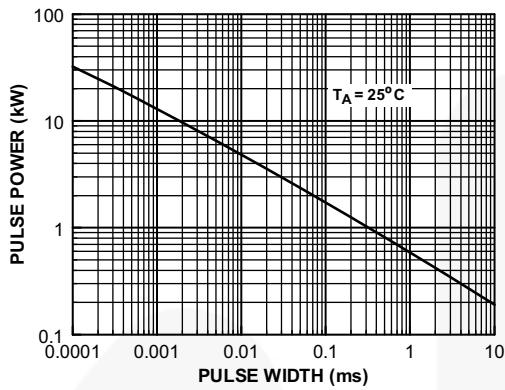

Figure 1. Peak Pulse Power Rating Curve

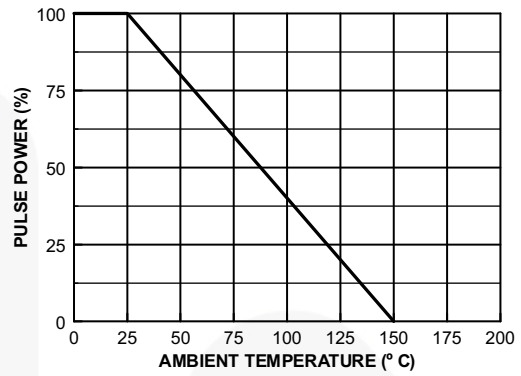

Figure 2. Pulse Derating Curve

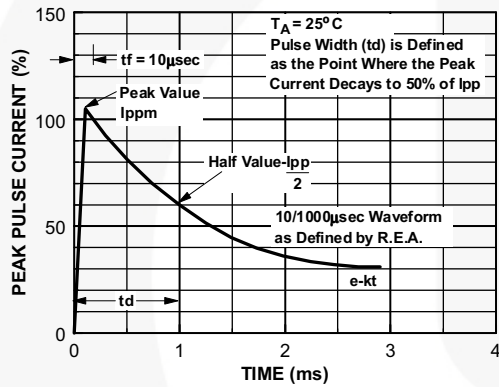

Figure 3. Pulse Waveform

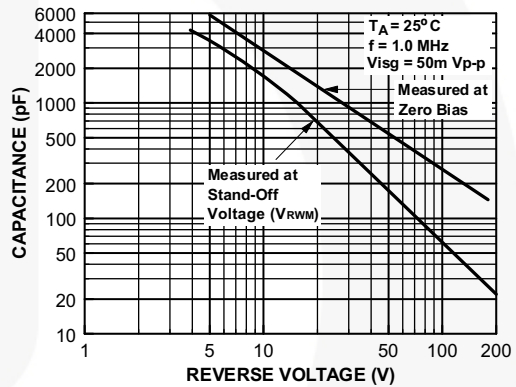

Figure 4. Junction Capacitance

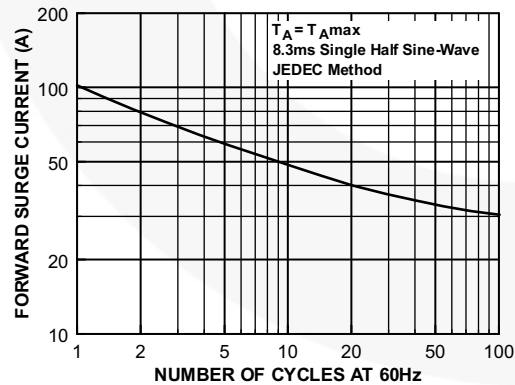
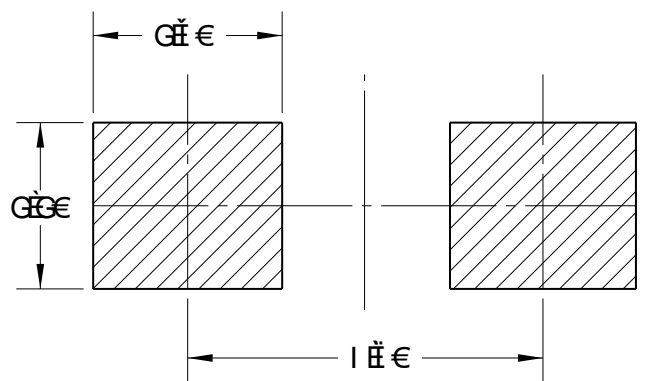
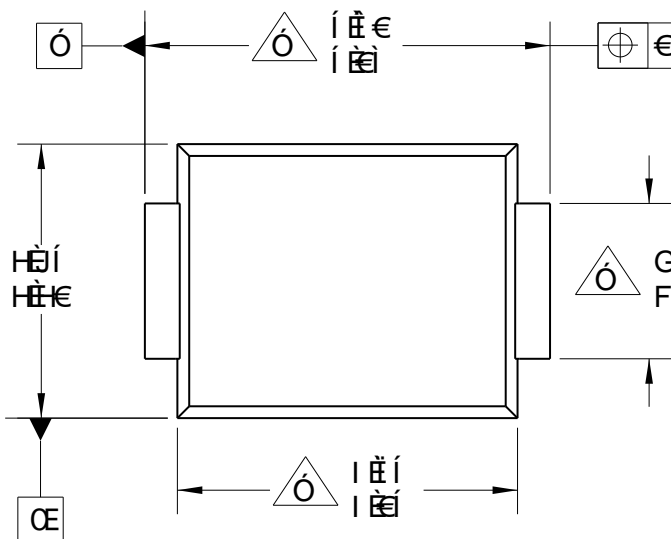

Figure 5. Non-Repetitive Surge Current

VP:SHOBY Φ ΟΑΒΑΡΡΑΔΙΙΙΟΟΥΥΑΙΟΚΩΣΦΟΒΑΜΤ ΘΕΡΟΝΟΥΙΙΙΟΙΙΙΟΟΒΕΡΒΗΒΗΑΜΙΟ
 VP:OOUΦΑΡΓΕΣΣΟΤ ΓΕΔΑΥΡΟΑΡΦΑΕΑΒΙΟΟΟΟΕΟΑΚΑΙΔΑΙΙΙΙΙΙΙΙΙΙΙΙΙΙΙΙΙΙΙΙΙΙΙΙΙΙΙΙΙΙΙΙ
 VU:ΑΒΕΣΦΟΒΑΜΤ ΘΕΡΟΝΟΥΙΙΙΟΙΙΙΟΟΒΕΡΒΗΒΗΑΜΙΟΑΙΙΙΙΙΙΙΙΙΙΙΙΙΙΙΙΙΙΙΙΙΙΙΙΙΙΙΙΙΙΙ
 Y ΦΑΡΑΦΑΡΑΙΙΙ
 ΟΙΙ
 ΟΙΙΙ
 U:ΑΡ:SHOBY Φ ΟΑΒΑΡΡΑΔΙΙΙΟΟΥΥΑΙΟΚΩΣΦΟΒΑΜΤ ΘΕΡΟΝΟΥΙΙΙΟΙΙΙΟΟΒΕΡΒΗΒΗΑΜΙΟ
 U:ΑΡ:SHOBY Φ ΟΑΒΑΡΡΑΔΙΙΙΟΟΥΥΑΙΟΚΩΣΦΟΒΑΜΤ ΘΕΡΟΝΟΥΙΙΙΟΙΙΙΟΟΒΕΡΒΗΒΗΑΜΙΟ

ΎΟΧΩΠΒΎ			
ΡΟΎ	ΟΟΥΟΎΩΠΩΠ	ΟΕ/Ο	ΟΎΘΕΎΟ
F	ΎΟΣΟΑΎΟΑΎΑΎΟ	FJT ΟΎΓΕΕ	ΎΟΣΟΑΎΟΎ



ΣΟΒ ΟΑΎΟΕ/ΝΟΥΡΑΎΟΟΎΤ Τ ΟΡΟΕ/ΩΠ

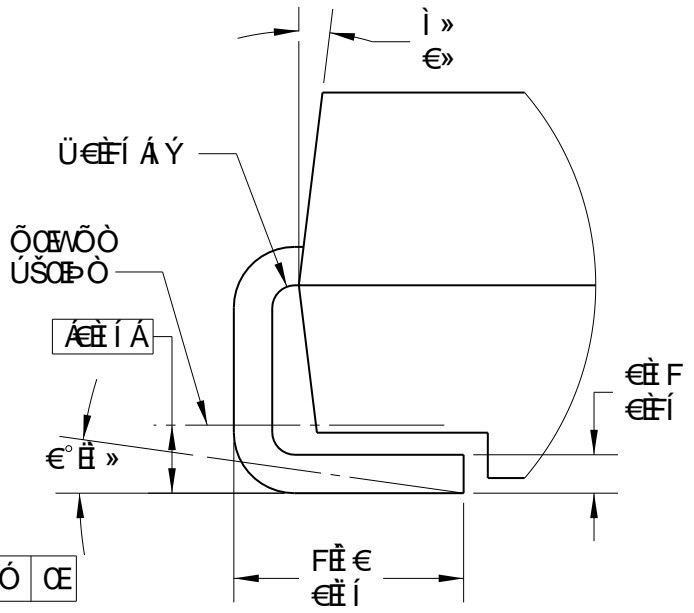
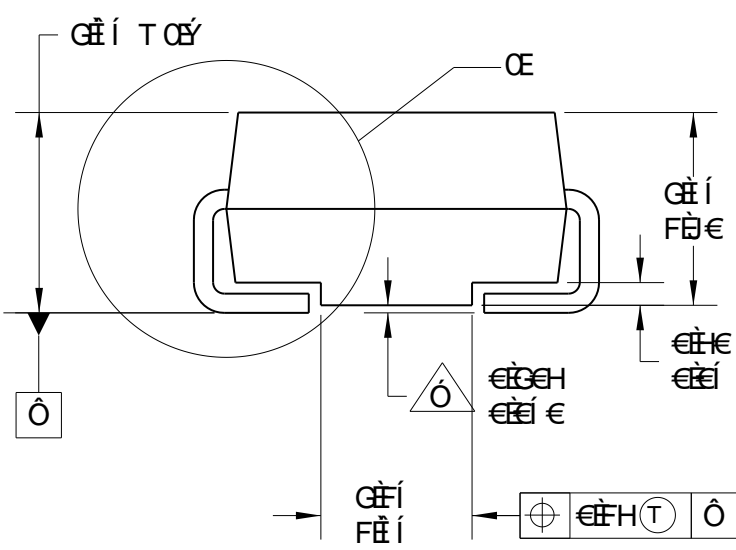

ΡΥΝΟΎΚ

ΑΕΎΟΎ ΟΟΥΥΑ ΡΟΎΟΑ ΡΥΝΟΎΟΎΡΑΎΎΤ ΎΑΎΑ
 ΡΟΎΟΎΟΎΓΦΙ ΑΚΕΎΟΕ/ΩΠΑΎΕ
 Ο ΟΟΥΑ ΡΥΝΟΎΤ ΎΣΎΑ ΡΟΎΟΎΑΎΒΑΚΕΣΩΕ
 ΑΟΕΑΕΣΑΎΟ ΟΡΎΩΠΎΑΎΎΟΑΤ ΣΣΑ ΟΝΟΎΎΕ
 ΑΟΕΎΟ ΟΡΎΩΠΎΑΎΕΎΟΎΎΩΣΎΎΑΎΑΎΑΎΑΎΎΎΎΎ
 ΑΤ ΎΣΑΎΣΟΕΡΑΎΕΡΑΎΑΎΑΎΑΎΎΎΎΎΎΎΎΎΎΎ
 ΑΟΕΎΟ ΟΡΎΩΠΎΑΎΕΡΑΎΎΎΎΎΎΎΎΎΎΎΎΎΎΎΎΎ
 ΎΦΙ ΎΎΎΎΎ
 ΑΟΕΎΟ ΟΑΎΟΕ/ΝΟΥΡΑΎΟΎΎΎΎΎΎΎΎΎΎΎΎΎΎΎΎΎ
 ΑΟΕΎΟ ΟΑΎΟΕ/ΝΟΥΡΑΎΟΎΎΎΎΎΎΎΎΎΎΎΎΎΎΎΎΎ

ΑΕΎΎΎΎΎΎΎ	ΟΕ/Ο		ΓΣΟΕΎΤ ΟΑΡΟΎΟΎ ΟΎΓΦΙ ΑΚΕΎΟΕ/ΩΠΑΎΕ		
ΟΎΟΎ ΡΚ ΟΟΥΎΑΤ ΟΣΎ	FJT ΟΎΓΕΕ				
ΟΡΟΎΟΎΚ ΎΟΑΎΟ					
ΑΕΎΎΎΎΎΎΚ ΑΎΟΑΎΟ					
ΑΕΎΎΎΎΎΎΚ ΡΥΎ ΑΕΎΟΑΎΕΣΎ		ΎΟΎΟΎ FJK	ΎΑΎΟ Ρ:ΘΕ	ΟΎΟΎ ΦΟΎΎΎΎΎΎΎ Τ ΣΒΕΎΟΎΓΦΙ ΟΕΕ	ΎΟΎΚ F
ΎΎΎΎΎΎΎΎ		ΟΎΎΤ ΟΎΣΤΚ Ρ:ΘΕ	ΎΡΟΎΎΚ: ΡΑΎΦ		



TRADEMARKS

The following includes registered and unregistered trademarks and service marks, owned by Fairchild Semiconductor and/or its global subsidiaries, and is not intended to be an exhaustive list of all such trademarks.

- | | | | |
|--------------------------|--|---------------------------------------|------------------|
| AccuPower™ | F-PFS™ | OPTOPLANAR® | SYSTEM GENERAL® |
| AttitudeEngine™ | FRFET® | Power Supply WebDesigner™ | TinyBoost® |
| Awinda® | Global Power Resource SM | PowerTrench® | TinyBuck® |
| AX-CAP®* | GreenBridge™ | PowerXS™ | TinyCalc™ |
| BitSiC™ | Green FPS™ | Programmable Active Droop™ | TinyLogic® |
| Build it Now™ | Green FPS™ e-Series™ | QFET® | TINYOPTO™ |
| CorePLUS™ | Gmax™ | QS™ | TinyPower™ |
| CorePOWER™ | GTO™ | Quiet Series™ | TinyPWM™ |
| CROSSVOL™ | IntelliMAX™ | RapidConfigure™ | TinyWire™ |
| CTL™ | ISOPLANAR™ | Saving our world, 1mW/W/kW at a time™ | TranSiC™ |
| Current Transfer Logic™ | Making Small Speakers Sound Louder and Better™ | SignalWise™ | TriFault Detect™ |
| DEUXPEED® | MegaBuck™ | SmartMax™ | TRUECURRENT®* |
| Dual Cool™ | MICROCOUPLER™ | SMART START™ | μSerDes™ |
| EcoSPARK® | MicroFET™ | Solutions for Your Success™ | UHC® |
| EfficientMax™ | MicroPak™ | SPM® | Ultra FRFET™ |
| ESBC™ | MicroPak2™ | STEALTH™ | UniFET™ |
| F [®] | MillerDrive™ | SuperFET® | Vcx™ |
| Fairchild® | MotionMax™ | SuperSOT™-3 | VisualMax™ |
| Fairchild Semiconductor® | MotionGrid® | SuperSOT™-6 | VoltagePlus™ |
| FACT Quiet Series™ | MTI® | SuperSOT™-8 | Xsens™ |
| FACT® | MTx® | SupreMOS® | 仙童™ |
| FAST® | MVN® | SyncFET™ | |
| FastvCore™ | mWSaver® | Sync-Lock™ | |
| FETBench™ | OptoHiT™ | | |
| FPS™ | OPTOLOGIC® | | |

* Trademarks of System General Corporation, used under license by Fairchild Semiconductor.

DISCLAIMER

FAIRCHILD SEMICONDUCTOR RESERVES THE RIGHT TO MAKE CHANGES WITHOUT FURTHER NOTICE TO ANY PRODUCTS HEREIN TO IMPROVE RELIABILITY, FUNCTION, OR DESIGN. TO OBTAIN THE LATEST, MOST UP-TO-DATE DATASHEET AND PRODUCT INFORMATION, VISIT OUR WEBSITE AT [HTTP://WWW.FAIRCHILDSEMI.COM](http://www.fairchildsemi.com). FAIRCHILD DOES NOT ASSUME ANY LIABILITY ARISING OUT OF THE APPLICATION OR USE OF ANY PRODUCT OR CIRCUIT DESCRIBED HEREIN; NEITHER DOES IT CONVEY ANY LICENSE UNDER ITS PATENT RIGHTS, NOR THE RIGHTS OF OTHERS. THESE SPECIFICATIONS DO NOT EXPAND THE TERMS OF FAIRCHILD'S WORLDWIDE TERMS AND CONDITIONS, SPECIFICALLY THE WARRANTY THEREIN, WHICH COVERS THESE PRODUCTS.

AUTHORIZED USE

Unless otherwise specified in this data sheet, this product is a standard commercial product and is not intended for use in applications that require extraordinary levels of quality and reliability. This product may not be used in the following applications, unless specifically approved in writing by a Fairchild officer: (1) automotive or other transportation, (2) military/aerospace, (3) any safety critical application – including life critical medical equipment – where the failure of the Fairchild product reasonably would be expected to result in personal injury, death or property damage. Customer's use of this product is subject to agreement of this Authorized Use policy. In the event of an unauthorized use of Fairchild's product, Fairchild accepts no liability in the event of product failure. In other respects, this product shall be subject to Fairchild's Worldwide Terms and Conditions of Sale, unless a separate agreement has been signed by both Parties.

ANTI-COUNTERFEITING POLICY

Fairchild Semiconductor Corporation's Anti-Counterfeiting Policy. Fairchild's Anti-Counterfeiting Policy is also stated on our external website, www.fairchildsemi.com, under Terms of Use

Counterfeiting of semiconductor parts is a growing problem in the industry. All manufacturers of semiconductor products are experiencing counterfeiting of their parts. Customers who inadvertently purchase counterfeit parts experience many problems such as loss of brand reputation, substandard performance, failed applications, and increased cost of production and manufacturing delays. Fairchild is taking strong measures to protect ourselves and our customers from the proliferation of counterfeit parts. Fairchild strongly encourages customers to purchase Fairchild parts either directly from Fairchild or from Authorized Fairchild Distributors who are listed by country on our web page cited above. Products customers buy either from Fairchild directly or from Authorized Fairchild Distributors are genuine parts, have full traceability, meet Fairchild's quality standards for handling and storage and provide access to Fairchild's full range of up-to-date technical and product information. Fairchild and our Authorized Distributors will stand behind all warranties and will appropriately address any warranty issues that may arise. Fairchild will not provide any warranty coverage or other assistance for parts bought from Unauthorized Sources. Fairchild is committed to combat this global problem and encourage our customers to do their part in stopping this practice by buying direct or from authorized distributors.

PRODUCT STATUS DEFINITIONS

Definition of Terms

Datasheet Identification	Product Status	Definition
Advance Information	Formative / In Design	Datasheet contains the design specifications for product development. Specifications may change in any manner without notice.
Preliminary	First Production	Datasheet contains preliminary data; supplementary data will be published at a later date. Fairchild Semiconductor reserves the right to make changes at any time without notice to improve design.
No Identification Needed	Full Production	Datasheet contains final specifications. Fairchild Semiconductor reserves the right to make changes at any time without notice to improve the design.
Obsolete	Not In Production	Datasheet contains specifications on a product that is discontinued by Fairchild Semiconductor. The datasheet is for reference information only.

Rev. I75