

Main

Range of product	Preventa Safety detection
Product or component type	Safety light curtain type 4
Device short name	XUSL4E
Output type	2 safety outputs OSSD solid-state PNP (integrated arc suppression)
Product specific application	For finger protection
[R] Resolution	14 mm
[Sn] nominal sensing distance	0...2 m by cabling 1...5 m by cabling
[Hp] Height protected	760 mm
Number of beams	75
Type of start / restart	Automatic Manual
External Device Monitoring (EDM)	Selected by wiring

Complementary

Detection system	Transmitter-receiver system
Response time	11 ms
Kit composition	1 PVC cable(s) Silicone o-ring(s) 1 user guide with certificate of conformity on CD-ROM 1 transmitter(s) 1 receiver(s) Adjustable mounting bracket(s)
[EAA] effective aperture angle	+/- 2.5 ° at 3 m
Emission	IR LED (λ = 950 nm)
[Us] rated supply voltage	24 V DC (+/- 20 %)
Supply	Power supply must meet requirements of IEC 60204-1 Power supply must meet requirements of IEC 61496-1
[Ie] rated operational current	2 A
Current consumption	900 mA with maximum load (receiver) 42 mA (transmitter) 83 mA no-load (receiver) 42 mA no-load (transmitter)
Output current limits	0.4 A for safety outputs OSSD
Output voltage	24 V
Output circuit type	DC
Voltage drop	<= 0.5 V
Maximum Heating system power consumption	10 W
Local signalling	2 dual colour LEDs (receiver) 1 multi-colour LED (transmitter)
Electrical connection	1 male connector M12 8 pins (receiver) 1 male connector M12 5 pins (transmitter)
Type of cable	AWG 22 unshielded cable of 10 m
Ohmic cable resistance (per m)	55.31 mOhm

The information provided in this documentation contains general descriptions and/or technical characteristics of the performance of the products contained herein. This documentation is not intended as a substitute for and is not to be used for determining suitability or reliability of these products for specific user applications. It is the duty of any such user or integrator to perform the appropriate and complete risk analysis, evaluation and testing of the products with respect to the relevant specific application or use thereof. Neither Schneider Electric Industries SAS nor any of its affiliates or subsidiaries shall be responsible or liable for misuse of the information contained herein.

Function available	Anti-condensation system LED display of operating modes and faults Muting through external safety module XPSLCMUT1160 Test
Marking	CE
Material	Cable : PVC (polyvinyl chloride) Sealing plug : stainless steel AISI 316L Tube : PMMA (polymethyl methacrylate)
Housing colour	RAL 3000 : red
Fixing mode	By fixing brackets
Product weight	5.55 kg
Offer type	Standard distance
Provided equipment	With heating system

Environment

Directives	89/336/EEC - electromagnetic compatibility 2002/96/EC - WEEE directive 2002/95/EC - RoHS directive 98/37/EEC - machinery 89/655/EEC - work equipment
Product certifications	CE CULus TÜV
Safety level (correctly wired)	PL = e conforming to EN/ISO 13849-1 Category 4 conforming to EN/ISO 13849-1 SILCL 3 conforming to IEC 62061 SIL 3 conforming to IEC 61508 Type 4 conforming to IEC 61496-1
Optical characteristic	Resistance to light disturbance conforming to EN/IEC 61496-2
Mission time	20 yr
Safety reliability data	PFHd = 1.19E-8 1/h conforming to IEC 61508
Ambient air temperature for operation	-25...55 °C -13...131 °F
Ambient air temperature for storage	-25...70 °C -13...158 °F
Relative humidity	<= 95 % without condensation
IP degree of protection	IP69K
Shock resistance	10 gn for 16 ms conforming to IEC 61496-1
Vibration resistance	0.35 +/- 0.05 mm (f = 10...55 Hz) conforming to IEC 61496-1

Offer Sustainability

Sustainable offer status	Green Premium product
RoHS (date code: YYWW)	Compliant - since 1425 - Schneider Electric declaration of conformity
REACH	Reference not containing SVHC above the threshold
Product environmental profile	Available Download Product Environmental
Product end of life instructions	Available Download End Of Life Manual

Dimensions

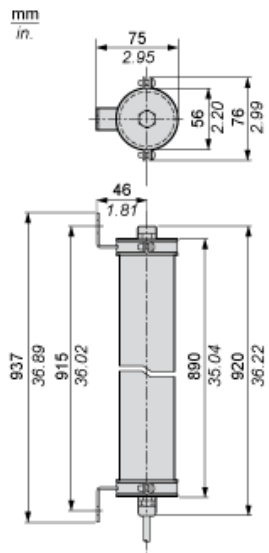

Mounting and Clearance

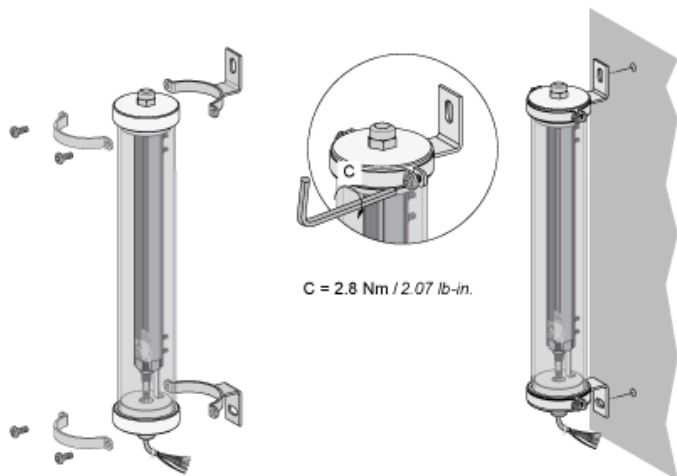

Wiring Diagrams

Transmitter Pre-wired

Brown: +24 Vdc

White: Configuration_0

Blue: 0 Vdc

Green or Black: Configuration_1

Grey: Functional Earth

Yellow: 0 Vdc (Heating system)

Red: +24 Vac/Vdc (Heating system)

Pink: Not connected

Receiver pre-wired

White: Output signal switching device 1

Brown: +24 Vdc

Green: Output signal switching device 2

Yellow: Configuration_A

Grey: K1_K2 Feedback/Restart

Pink: Configuration_B

Blue: 0 Vdc

Yellow/Green (or Red): Functional Earth

Black: 0 Vdc (Heating system)

Violet: 24 Vac/Vdc (Heating system)

For configuration_A and configuration_B, please refer to receiver configuration and operating modes

Receiver Configurations and Operating Modes

Automatic Start/Restart

Without External Device Monitoring (EDM) feedback loop

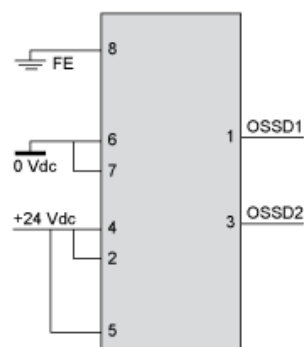

With External Device Monitoring (EDM) feedback loop

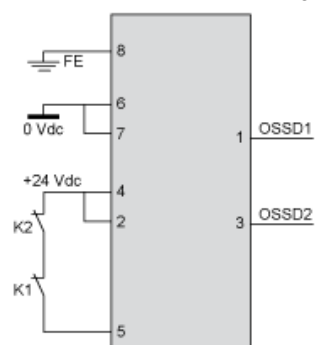

Manual Start/Restart

Without External Device Monitoring (EDM) feedback loop

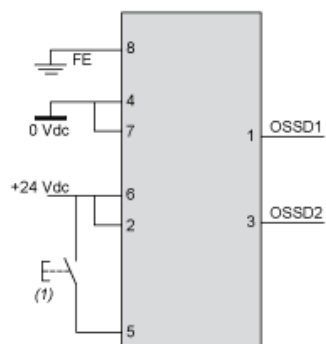

(1) Restart

With External Device Monitoring (EDM) feedback loop

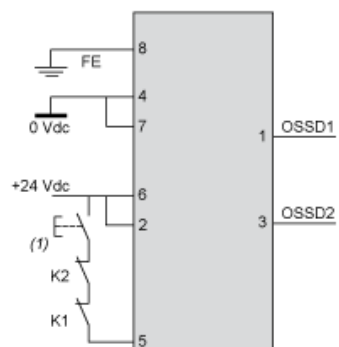

(1) Restart