

# Bridgelux® Decor Series™ Class A LED Array

Product Data Sheet DS35



BXRC-30A1001

30A2001

30A4001

30A10K1

BXRC-40A1001

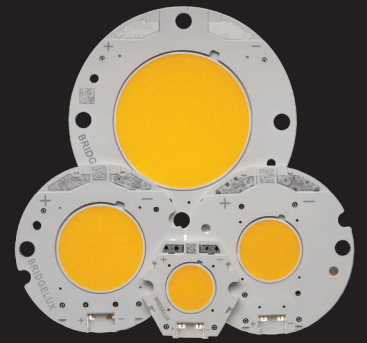
40A2001

40A4001

40A10K1

# Introduction

Vero



Bridgelux® Décor Series™ Class A products are a revolutionary advancement in lighting designed to match how humans perceive and prefer light. The Class A specification was created by the Lighting Research Center (LRC) behavior studies in conjunction with Bridgelux and other ASSIST members. Based on human factor response testing, the Décor Series Class A products provide vibrant, natural and brilliant looking light, evoking an emotional attraction and response. The Décor Series Class A products were developed for high-end retail, museum, architectural, premium building and hospitality applications.

Bridgelux Décor Series Class A products are available on all Vero form factors. The Vero platform has been engineered with advanced connectivity options and can operate over a broad current range, enabling multiple degrees of flexibility in luminaire design optimization.

## Features

- Light quality is based on human perception of color and light
- High gamut area index (GAI)
- No harmful UV or near IR light in the spectrum
- Substantially broader GAI and color spectrum than halogen
- Radial die pattern enhances optical uniformity
- Based on Bridgelux Vero COB LED array platform

## Benefits

- Broad application coverage for interior and exterior lighting
- Flexibility for application driven lighting design requirements
- High quality true color reproduction
- Uniform consistent white light
- Flexibility in design optimization
- Enhanced ease of use and manufacturability

# Contents

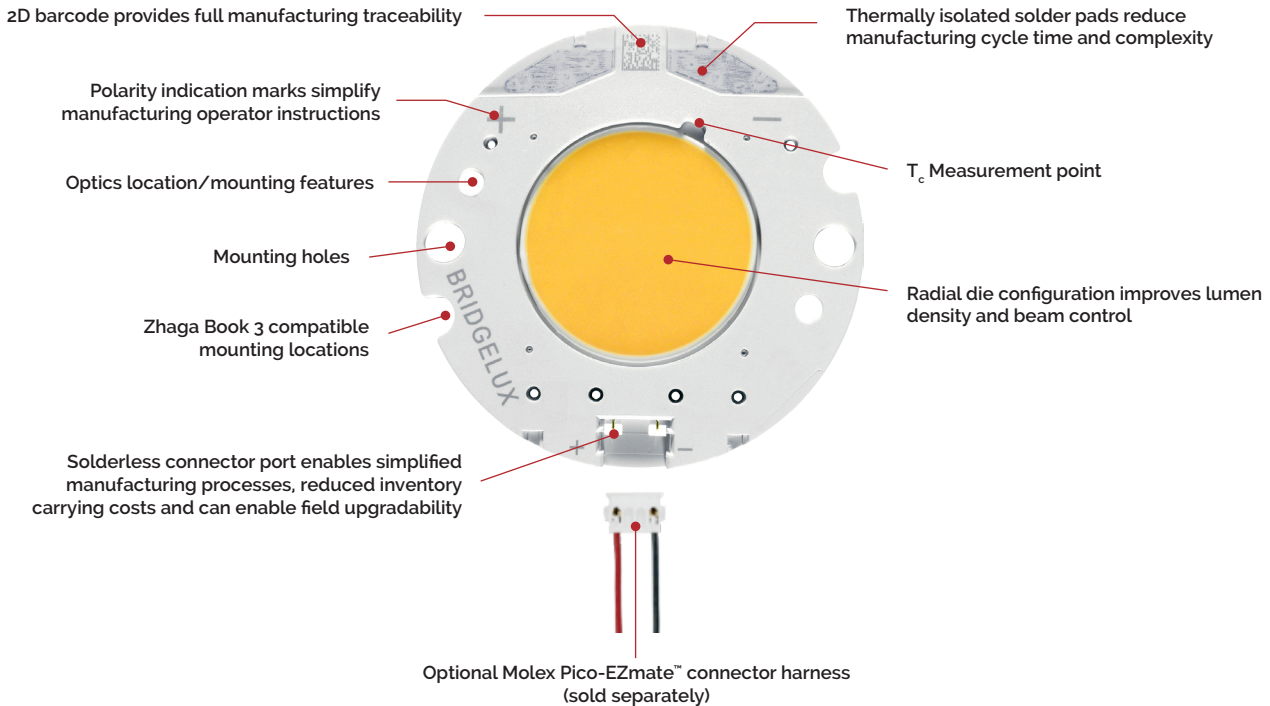
Product Feature Map	2
Product Nomenclature	2
Product Selection Guide	3
Performance at Commonly Used Drive Currents	5
Electrical Characteristics	7
Absolute Maximum Ratings	8
Performance Curves	9
Typical Radiation Pattern	16
Mechanical Dimensions	17
Packaging	21
Design Resources	24
Precautions	24
Disclaimers	24
About Bridgelux	25

---

# Product Feature Map

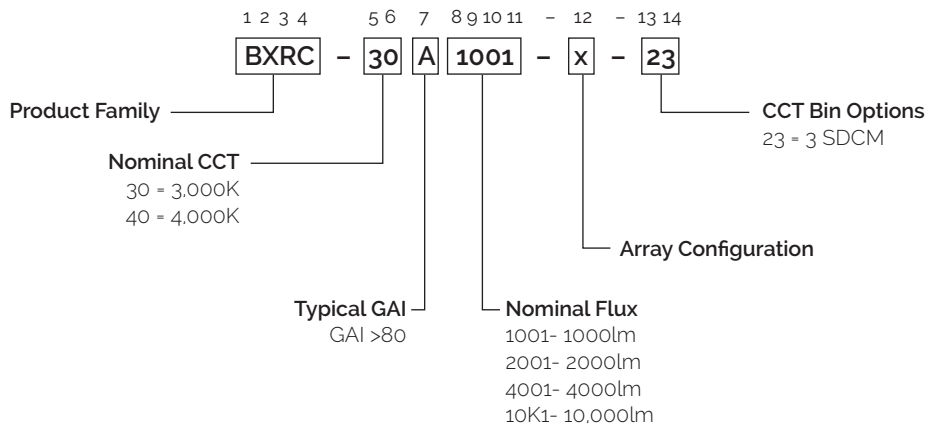
In addition to delivering the performance and light quality required for many lighting applications, Décor Series Class A LED arrays incorporate several features to

simplify the design integration and manufacturing process, accelerate time to market and reduce system costs.



## Product Nomenclature

The part number designation for Bridgelux Vero LED arrays is explained as follows:



# Product Selection Guide

The following product configurations are available:

**Table 1:** Selection Guide, Pulsed Measurement Data ( $T_j = T_c = 25^\circ\text{C}$ )

Product	Part Number	Nominal CCT <sup>1</sup> (K)	GAI <sup>2</sup>	CRI <sup>3</sup>	Nominal Drive Current <sup>4</sup> (mA)	Typical Pulsed Flux <sup>5,6,7</sup> $T_c = 25^\circ\text{C}$ (lm)	Minimum Pulsed Flux <sup>7,8</sup> $T_c = 25^\circ\text{C}$ (lm)	Typical $V_f$ (V)	Typical Power (W)	Typical Efficacy (lm/W)
Décor Class A Vero 10	BXRC-30A1001-B-23	3000	80	93	350	820	750	26.5	9.3	88
Décor Class A Vero 10	BXRC-40A1001-B-23	4000	80	93	350	970	900	26.5	9.3	105
Décor Class A Vero 13	BXRC-30A2001-C-23	3000	80	93	500	1500	1394	32.3	16.2	93
Décor Class A Vero 13	BXRC-40A2001-C-23	4000	80	93	500	1740	1625	32.3	16.2	108
Décor Class A Vero 18	BXRC-30A4001-F-23	3000	80	93	1050	2897	2695	29.5	31.0	94
Décor Class A Vero 18	BXRC-40A4001-F-23	4000	80	93	1050	3385	3157	29.5	31.0	109
Décor Class A Vero 29	BXRC-30A10K1-L-23	3000	80	93	2100	7483	7014	38	79.8	94
Décor Class A Vero 29	BXRC-40A10K1-L-23	4000	80	93	2100	8666	8054	38	79.8	109

**Table 2:** Selection Guide, Stabilized DC Performance ( $T_c = 70^\circ\text{C}$ )<sup>9,10</sup>

Product	Part Number	Nominal CCT <sup>1</sup> (K)	GAI <sup>2</sup>	CRI <sup>3</sup>	Nominal Drive Current <sup>4</sup> (mA)	Typical DC Flux <sup>5,6,7</sup> $T_c = 70^\circ\text{C}$ (lm)	Minimum DC Flux <sup>7,11</sup> $T_c = 70^\circ\text{C}$ (lm)	Typical $V_f$ (V)	Typical Power (W)	Typical Efficacy (lm/W)
Décor Class A Vero 10	BXRC-30A1001-B-23	3000	80	93	350	752	688	25.8	9.0	83
Décor Class A Vero 10	BXRC-40A1001-B-23	4000	80	93	350	888	824	25.8	9.0	98
Décor Class A Vero 13	BXRC-30A2001-C-23	3000	80	93	500	1377	1280	31.5	15.8	87
Décor Class A Vero 13	BXRC-40A2001-C-23	4000	80	93	500	1597	1491	31.5	15.8	101
Décor Class A Vero 18	BXRC-30A4001-F-23	3000	80	93	1050	2638	2454	28.7	30.2	87
Décor Class A Vero 18	BXRC-40A4001-F-23	4000	80	93	1050	3120	2910	28.7	30.2	103
Décor Class A Vero 29	BXRC-30A10K1-L-23	3000	80	93	2100	6886	6454	37.2	78.2	88
Décor Class A Vero 29	BXRC-40A10K1-L-23	4000	80	93	2100	7977	7414	37.2	78.2	102

Notes for Tables 1 & 2:

- Nominal CCT is defined by the Lighting Research Center's Class A definition. The center of the Class A color bin is on the corresponding isothermal line.
- To help ensure optimal fixture level performance, GAI is measured at the fixture level, on axis, at a case temperature of  $70^\circ\text{C}$ . GAI may vary depending on fixture design and performance.
- CRI Values are specified as typical. Typical R<sub>g</sub> value for 3000K products is 90. CRI and R Values are measured at 25C pulsed.
- Drive current is referred to as nominal drive current.
- Products tested under pulsed condition (10ms pulse width) at nominal test current where  $T_j$  (junction temperature) =  $T_c$  (case temperature) =  $25^\circ\text{C}$ .
- Typical performance values are provided as a reference only and are not a guarantee of performance.
- Bridgelux maintains a  $\pm 7\%$  tolerance on flux measurements.
- Minimum flux values at the nominal test current are guaranteed by 100% test.
- Typical stabilized DC performance values are provided as reference only and are not a guarantee of performance.
- Typical performance is estimated based on operation under DC (direct current) with LED array mounted onto a heat sink with thermal interface material and the case temperature maintained at specified temperature. Based on Bridgelux test setup, values may vary depending on the thermal design of the luminaire and/or the exposed environment to which the product is subjected.
- Minimum flux values at elevated temperatures are provided for reference only and are not guaranteed by 100% production testing. Based on Bridgelux test setup, values may vary depending on the thermal design of the luminaire and/or the exposed environment to which the product is subjected.

# Product Selection Guide

The following product configurations are available:

**Table 3:** Selection Guide, Stabilized DC Performance ( $T_c = 85^\circ\text{C}$ )<sup>9,10</sup>

Product	Part Number	Nominal CCT <sup>1</sup> (K)	GAI <sup>2</sup>	CRI <sup>3</sup>	Nominal Drive Current <sup>4</sup> (mA)	Typical DC Flux <sup>5,6,7</sup> $T_c = 85^\circ\text{C}$ (lm)	Minimum DC Flux <sup>7,11</sup> $T_c = 85^\circ\text{C}$ (lm)	Typical $V_f$ (V)	Typical Power (W)	Typical Efficacy (lm/W)
Décor Class A Vero 10	BXRC-30A1001-B-23	3000	80	93	350	728	666	25.5	8.9	81
Décor Class A Vero 10	BXRC-40A1001-B-23	4000	80	93	350	861	799	25.5	8.9	96
Décor Class A Vero 13	BXRC-30A2001-C-23	3000	80	93	500	1332	1238	31.3	15.6	85
Décor Class A Vero 13	BXRC-40A2001-C-23	4000	80	93	500	1545	1443	31.3	15.6	99
Décor Class A Vero 18	BXRC-30A4001-F-23	3000	80	93	1050	2543	2365	28.6	30.0	85
Décor Class A Vero 18	BXRC-40A4001-F-23	4000	80	93	1050	3025	2821	28.6	30.0	101
Décor Class A Vero 29	BXRC-30A10K1-L-23	3000	80	93	2100	6668	6250	36.8	77.3	86
Décor Class A Vero 29	BXRC-40A10K1-L-23	4000	80	93	2100	7718	7173	36.8	77.3	100

Notes for Table :

- Nominal CCT is defined by the Lighting Research Center's Class A definition. The center of the Class A color bin is on the corresponding isothermal line.
- To help ensure optimal fixture level performance, GAI is measured at the fixture level, on axis, at a case temperature of  $70^\circ\text{C}$ . GAI may vary depending on fixture design and performance.
- CRI Values are specified as typical. Typical R9 value for 3000K products is 90. CRI and R Values are measured at  $25^\circ\text{C}$  pulsed.
- Drive current is referred to as nominal drive current.
- Products tested under pulsed condition (10ms pulse width) at nominal test current where  $T_j$  (junction temperature) -  $T_c$  (case temperature) =  $25^\circ\text{C}$ .
- Typical performance values are provided as a reference only and are not a guarantee of performance.
- Bridgelux maintains a  $\pm 7\%$  tolerance on flux measurements.
- Minimum flux values at the nominal test current are guaranteed by 100% test.
- Typical stabilized DC performance values are provided as reference only and are not a guarantee of performance.
- Typical performance is estimated based on operation under DC (direct current) with LED array mounted onto a heat sink with thermal interface material and the case temperature maintained at specified temperature. Based on Bridgelux test setup, values may vary depending on the thermal design of the luminaire and/or the exposed environment to which the product is subjected.
- Minimum flux values at elevated temperatures are provided for reference only and are not guaranteed by 100% production testing. Based on Bridgelux test setup, values may vary depending on the thermal design of the luminaire and/or the exposed environment to which the product is subjected.

# Performance at Commonly Used Drive Currents

Vero LED arrays are tested to the specifications shown using the nominal drive currents in Table 1. Vero may also be driven at other drive currents dependent on specific application design requirements. The performance at any drive current can be derived from the current vs. voltage characteristics shown in Figure 3-6 and the flux vs. current characteristics shown in Figures 7-10. The performance at commonly used drive currents is summarized in Table 4.

**Table 4:** Product Performance at Commonly Used Drive Currents

Product	Part Number	GAI	CRI	Drive Current <sup>1</sup> (mA)	Typical $V_f$ $T_c = 25^\circ\text{C}$ (V)	Typical Power $T_j = 25^\circ\text{C}$ (W)	Typical Flux <sup>2</sup> $T_c = 25^\circ\text{C}$ (lm)	Typical DC Flux <sup>3</sup> $T_c = 85^\circ\text{C}$ (lm)	Typical Efficacy $T_j = 25^\circ\text{C}$ (lm/W)
Décor Class A Vero 10	BXRC-30A1001-B-23	80	93	175	24.9	4.4	435	386	100
				<b>350</b>	<b>26.5</b>	<b>9.3</b>	<b>820</b>	<b>728</b>	<b>88</b>
				500	27.6	13.8	1116	991	81
				700	29.0	20.3	1454	1292	72
Décor Class A Vero 10	BXRC-40A1001-B-23	80	93	175	24.9	4.4	514	457	118
				<b>350</b>	<b>26.5</b>	<b>9.3</b>	<b>970</b>	<b>861</b>	<b>105</b>
				500	27.6	13.8	1321	1172	96
				700	29.0	20.3	1720	1527	85
Décor Class A Vero 13	BXRC-30A2001-C-23	80	93	175	30.2	5.3	572	508	108
				350	31.4	11.0	1095	972	100
				<b>500</b>	<b>32.3</b>	<b>16.2</b>	<b>1500</b>	<b>1332</b>	<b>93</b>
				700	33.4	23.4	1995	1772	85
				1050	35.1	36.9	2702	2400	73
Décor Class A Vero 13	BXRC-40A2001-C-23	80	93	175	30.2	5.3	663	589	125
				350	31.4	11.0	1270	1127	116
				<b>500</b>	<b>32.3</b>	<b>16.2</b>	<b>1740</b>	<b>1545</b>	<b>108</b>
				700	33.4	23.4	2314	2055	99
				1050	35.1	36.9	3134	2783	85
Décor Class A Vero 18	BXRC-30A4001-F-23	80	93	500	28.1	14.1	1483	1301	106
				700	28.7	20.1	2025	1777	101
				<b>1050</b>	<b>29.5</b>	<b>31.0</b>	<b>2897</b>	<b>2543</b>	<b>94</b>
				1400	30.2	42.3	3692	3241	87
				2100	31.6	66.4	5003	4391	75

Notes for Table 4:

1. Alternate drive currents in Table 4 are provided for reference only and are not a guarantee of performance.
2. Bridgelux maintains a  $\pm 7\%$  tolerance on flux measurements.
3. Typical stabilized DC performance values are provided as reference only and are not a guarantee of performance.

# Performance at Commonly Used Drive Currents

**Table 4:** Product Performance at Commonly Used Drive Currents

Product	Part Number	GAI	CRI	Drive Current <sup>1</sup> (mA)	Typical $V_f$ $T_c = 25^\circ\text{C}$ (V)	Typical Power $T_j = 25^\circ\text{C}$ (W)	Typical Flux <sup>2</sup> $T_c = 25^\circ\text{C}$ (lm)	Typical DC Flux <sup>3</sup> $T_c = 85^\circ\text{C}$ (lm)	Typical Efficacy $T_j = 25^\circ\text{C}$ (lm/W)
Décor Class A Vero 18	BXRC-40A4001-F-23	80	93	500	28.1	14.1	1732	1548	123
				700	28.7	20.1	2366	2114	118
				<b>1050</b>	<b>29.5</b>	<b>31.0</b>	<b>3385</b>	<b>3025</b>	<b>109</b>
				1400	30.2	42.3	4314	3855	102
				2100	31.6	66.4	5846	5224	88
Décor Class A Vero 29	BXRC-30A10K1-L-23	80	93	500	35.1	17.6	1964	1750	112
				700	35.6	24.9	2717	2421	109
				1050	36.4	38.2	3991	3556	104
				<b>2100</b>	<b>38.0</b>	<b>79.8</b>	<b>7483</b>	<b>6668</b>	<b>94</b>
				2800	39.0	109.2	9506	8470	87
				3150	39.5	124.4	10438	9301	84
Décor Class A Vero 29	BXRC-40A10K1-L-23	80	93	500	35.1	17.6	2275	2026	129
				700	35.6	24.9	3147	2803	126
				1050	36.4	38.2	4622	4116	121
				<b>2100</b>	<b>38.0</b>	<b>79.8</b>	<b>8666</b>	<b>7718</b>	<b>109</b>
				2800	39.0	109.2	11009	9805	101
				3150	39.5	124.4	12089	10767	97
				4200	40.4	169.7	14933	13300	88

Notes for Table 4:

1. Alternate drive currents in Table 4 are provided for reference only and are not a guarantee of performance.
2. Bridgelux maintains a  $\pm 7\%$  tolerance on flux measurements.
3. Typical stabilized DC performance values are provided as reference only and are not a guarantee of performance.



# Electrical Characteristics

**Table 5:** Electrical Characteristics

Part Number	Nominal Drive Current <sup>1</sup> (mA)	Forward Voltage Pulsed, T <sub>c</sub> = 25°C (V) <sup>1, 2, 3</sup>			Typical Coefficient of Forward Voltage <sup>4</sup> $\Delta V_f / \Delta T_c$ (mV/°C)	Typical Thermal Resistance Junction to Case <sup>5, 6</sup> R <sub>j-c</sub> (C/W)	Driver Selection Voltages <sup>7</sup> (V)	
		Minimum	Typical	Maximum			V <sub>f</sub> Min. Hot T <sub>c</sub> = 105°C (V)	V <sub>f</sub> Max. Cold <sup>4</sup> T <sub>c</sub> = -40°C (V)
BXRC-xxA1001-B-23	350	24.5	26.5	29.0	-16	0.47	23.2	29.5
	700	26.5	29.0	31.2	-16	0.59	25.2	32.2
BXRC-xxA2001-C-23	500	29.9	32.3	34.7	-17	0.22	28.5	35.8
	1050	32.0	35.1	37.9	-17	0.28	30.6	39.0
BXRC-xxA4001-F-23	1050	27.3	29.5	31.7	-15	0.13	26.1	32.7
	2100	29.2	31.6	34.2	-15	0.17	28.0	35.2
BXRC-xxA10K1-L-23	2100	35.2	38.0	40.9	-20	0.06	33.6	42.2
	4200	37.3	40.4	44.0	-20	0.07	35.7	45.3

Notes for Table 5:

1. Parts are tested in pulsed conditions, T<sub>c</sub> = 25°C. Pulse width is 10ms.
2. Voltage minimum and maximum are provided for reference only and are not a guarantee of performance.
3. Bridgelux maintains a tester tolerance of ± 0.10V on forward voltage measurements.
4. Typical coefficient of forward voltage tolerance is ± 0.1mV for nominal current.
5. Thermal resistance values are based from test data of a 3000K 80 CRI product.
6. Thermal resistance value was calculated using total electrical input power; optical power was not subtracted from input power.
7. V<sub>f</sub> min hot and max cold values are provided as reference only and are not guaranteed by test. These values are provided to aid in driver design and selection over the operating range of the product.

# Absolute Maximum Ratings

**Table 6:** Maximum Ratings

Parameter	Maximum Rating			
LED Junction Temperature	150°C			
Storage Temperature	-40°C to +105°C			
Operating Case Temperature <sup>1,2</sup>	105°C			
Soldering Temperature <sup>3</sup>	350°C or lower for a maximum of 10 seconds			
	BXRC-xxA1001-B-23	BXRC-xxA2001-C-23	BXRC-xxA4001-F-23	BXRC-xxA10K1-L-23
Maximum Drive Current <sup>1</sup>	700 mA	1050 mA	2100 mA	4200 mA
Maximum Peak Pulsed Drive Current <sup>4</sup>	1500 mA	1500 mA	3000 mA	6000 mA
Maximum Reverse Voltage <sup>5</sup>	-45V	-55 V	-55 V	-65 V

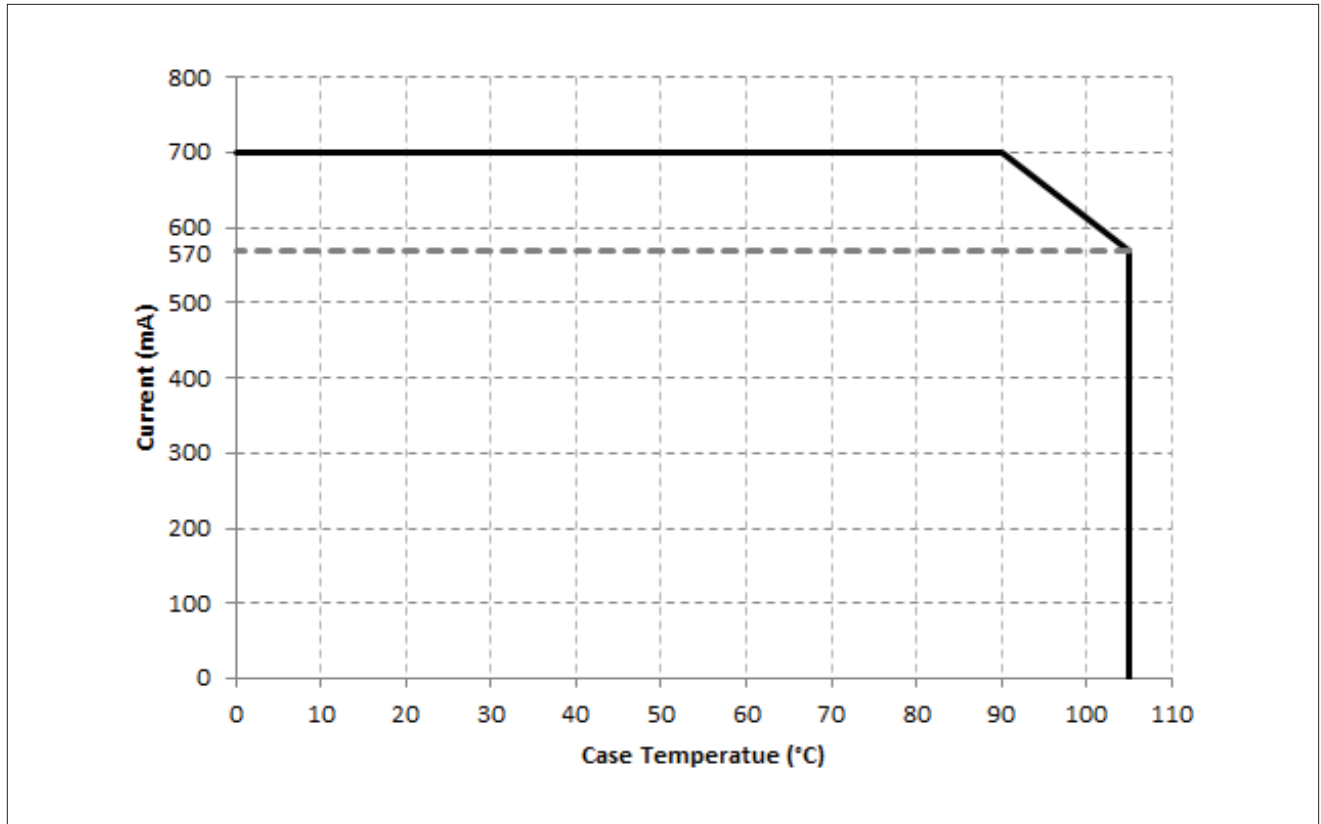
Notes for Table 6:

1. Please refer to Figures 1 and 2 for drive current derating curve for Vero 10 and Vero 29. Vero 13 and Vero 18 may be driven at 2 times nominal current upto 105°C.
2. For IEC 62717 requirement, please contact Bridgelux Sales Support.
3. See Bridgelux Application Note AN31, Assembly Considerations for Vero LED arrays, for more information.
4. Bridgelux recommends a maximum duty cycle of 10% and pulse width of 20ms when operating LED Arrays at the maximum peak pulsed current specified. Maximum peak pulsed current indicate values where the LED array can be driven without catastrophic failures.
5. Light emitting diodes are not designed to be driven in reverse voltage and will not produce light under this condition. Maximum rating provided for reference only.

# Performance Curves

The maximum allowable drive current for the Vero 10 and Vero 29 product families is dependent on the operating case temperature. Please refer to the Product Feature Map (page 2) for the location of the  $T_c$  Point.

**Figure 1: Vero 10 Drive Current Derating Curve**

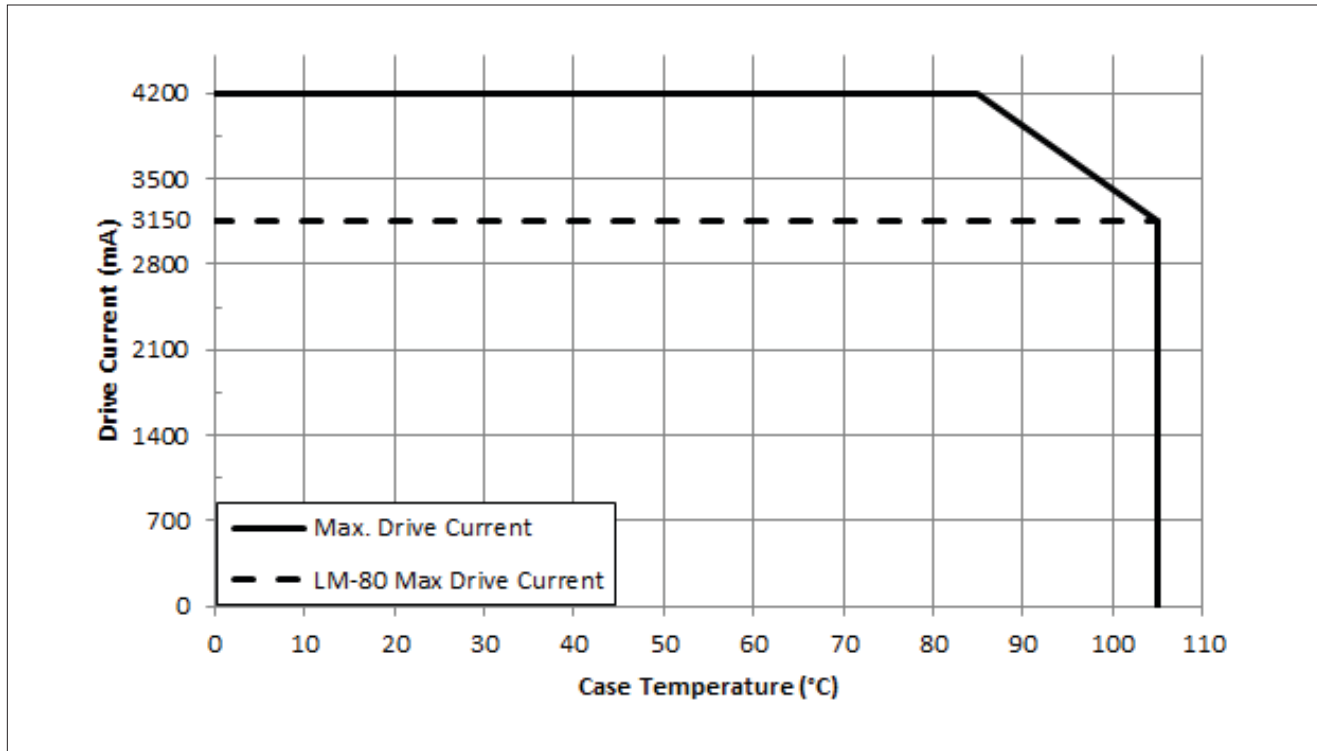


Notes for Figure 1:

1. In order to meet LM-80 lifetime projections Vero 10 may be driven up to 700mA at case temperatures up to 90°C. Operating conditions above case temperatures of 90°C driving conditions must follow the Vero 10 Drive Current Derating Curve.
2. Lumen maintenance (L70) and lifetime predictions are valid for drive current and case temperature conditions used for LM-80 testing as included in the applicable LM-80 test report for these products. Contact your Bridgelux sales representative for LM-80 report.

# Performance Curves

Figure 2: Vero 29 Drive Current Derating Curve



Notes for Figure 2:

1. LM-80 Max Drive Current must not be exceeded in order to meet LM-80 lifetime projections.
2. Lumen maintenance (L70) and lifetime predictions are valid for drive current and case temperature conditions used for LM-80 testing as included in the applicable LM-80 test report for these products. Contact your Bridgelux sales representative for LM-80 report.

# Performance Curves

Figure 3: **Vero 10 Drive Current vs. Forward Voltage**  
( $T_j=T_c=25^\circ\text{C}$ )

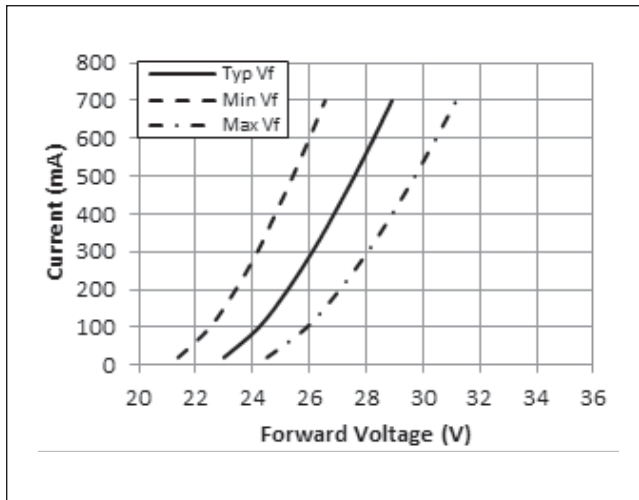


Figure 4: **Vero 13 Drive Current vs. Forward Voltage**  
( $T_j=T_c=25^\circ\text{C}$ )

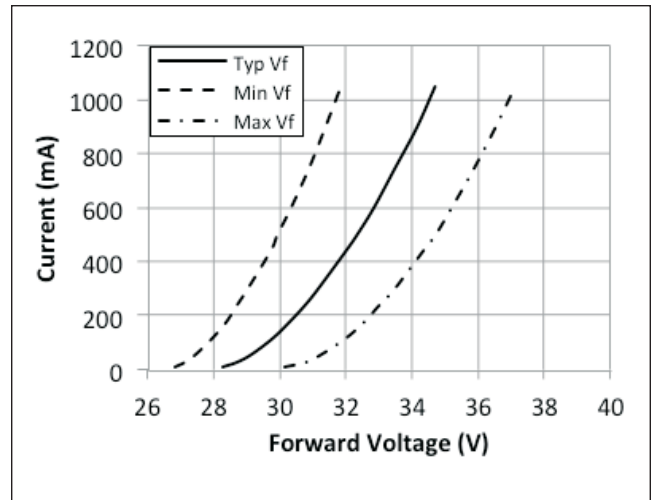


Figure 5: **Vero 18 Drive Current vs. Forward Voltage**  
( $T_j=T_c=25^\circ\text{C}$ )

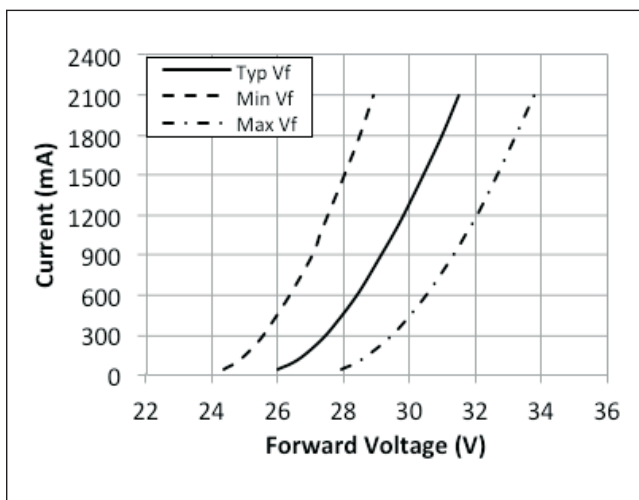
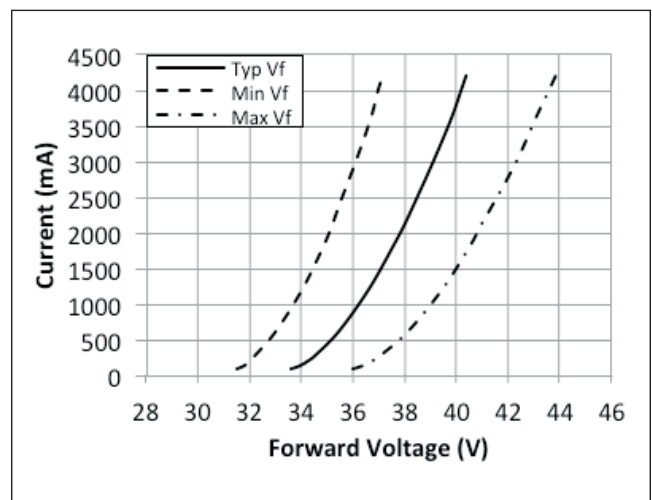
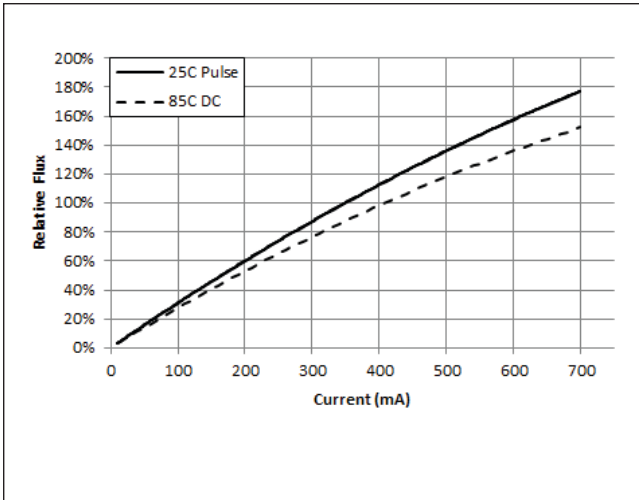


Figure 6: **Vero 29 Drive Current vs. Forward Voltage**  
( $T_j=T_c=25^\circ\text{C}$ )

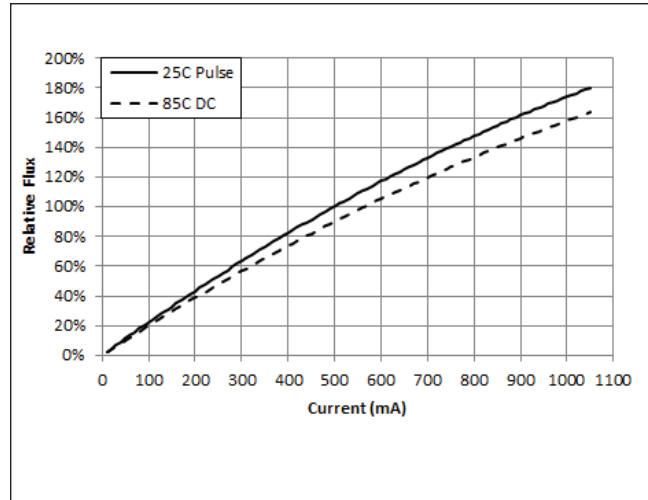


# Performance Curves

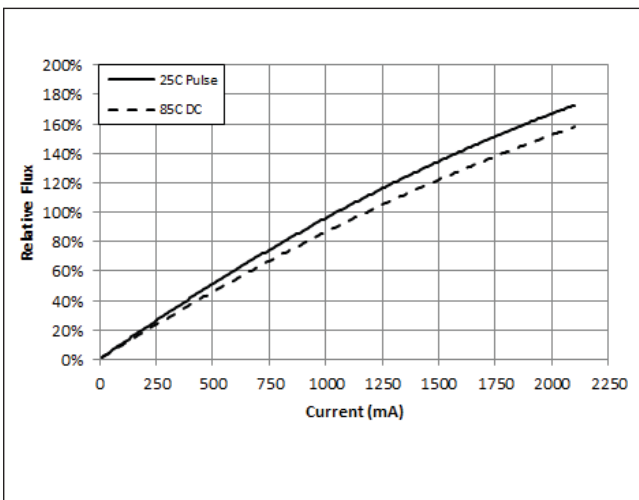
**Figure 7: Vero 10 Typical Relative Luminous Flux vs. Drive Current**



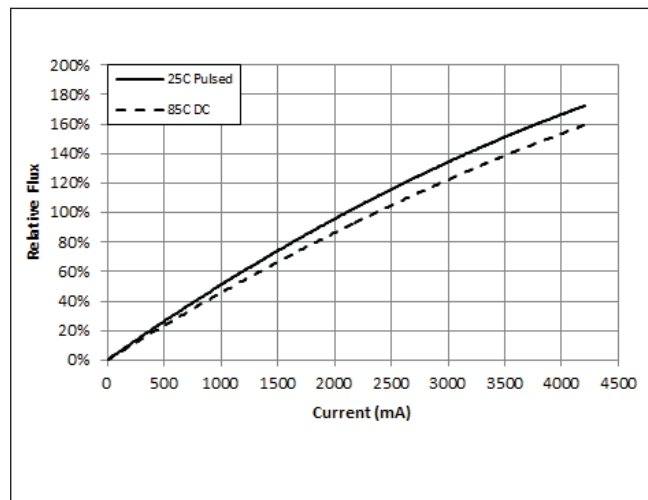
**Figure 8: Vero 13 Typical Relative Luminous Flux vs. Drive Current**



**Figure 9: Vero 18 Typical Relative Luminous Flux vs. Drive Current**

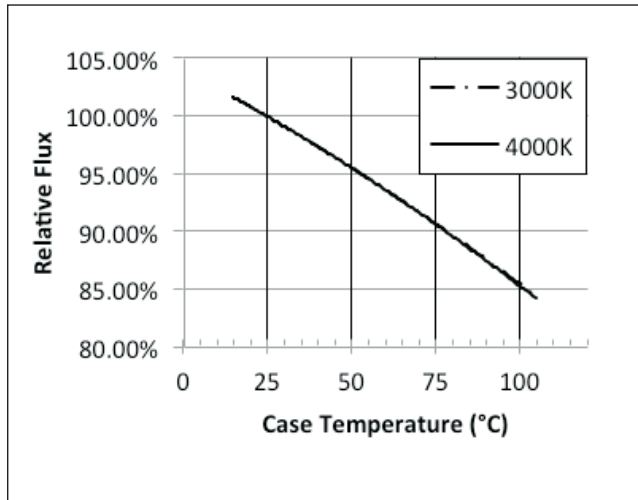


**Figure 10: Vero 29 Typical Relative Luminous Flux vs. Drive Current**

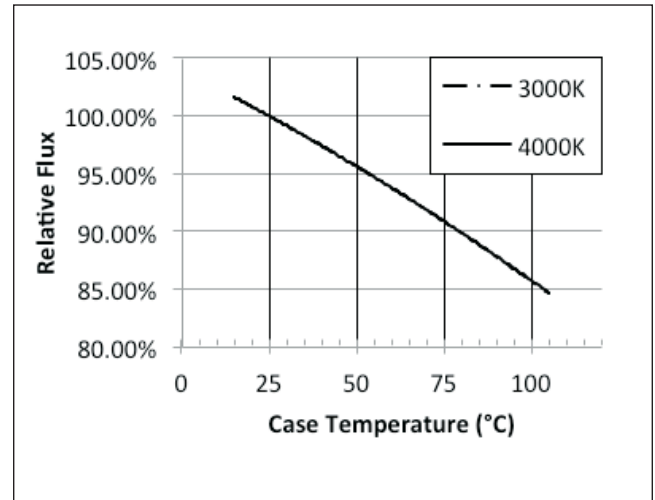


# Performance Curves

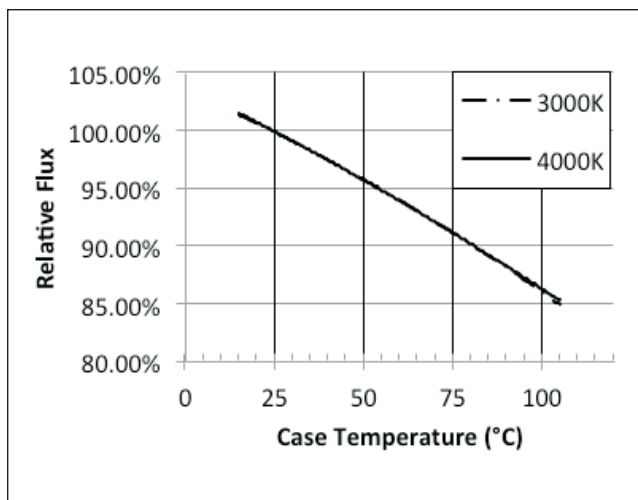
**Figure 11: Vero 10 Typical Relative Luminous Flux vs. Case Temperature**



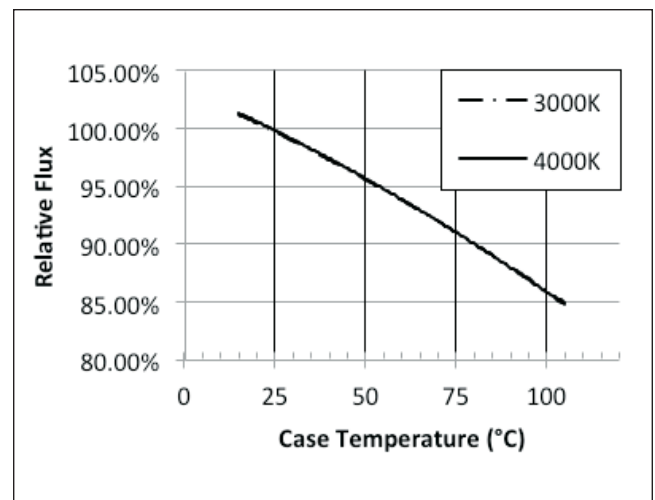
**Figure 12: Vero 13 Typical Relative Luminous Flux vs. Case Temperature**



**Figure 13: Vero 18 Typical Relative Luminous Flux vs. Case Temperature**



**Figure 14: Vero 29 Typical Relative Luminous Flux vs. Case Temperature**



Note for Figures 11-14:  
Flux measurements taken under DC conditions.

# Performance Curves

Figure 15: **Vero 10 Typical ccx Shift vs. Case Temperature**

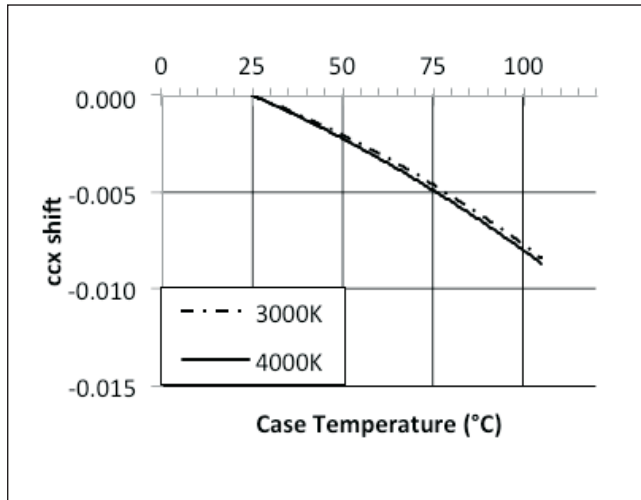


Figure 16: **Vero 10 Typical ccy Shift vs. Case Temperature**

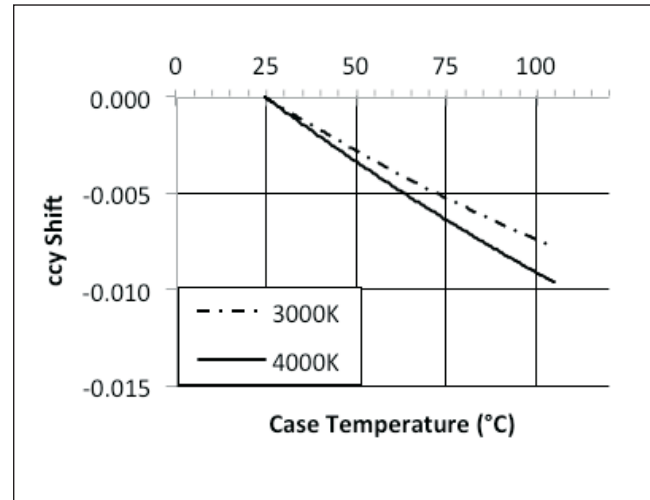


Figure 17: **Vero 13 Typical ccx Shift vs. Case Temperature**

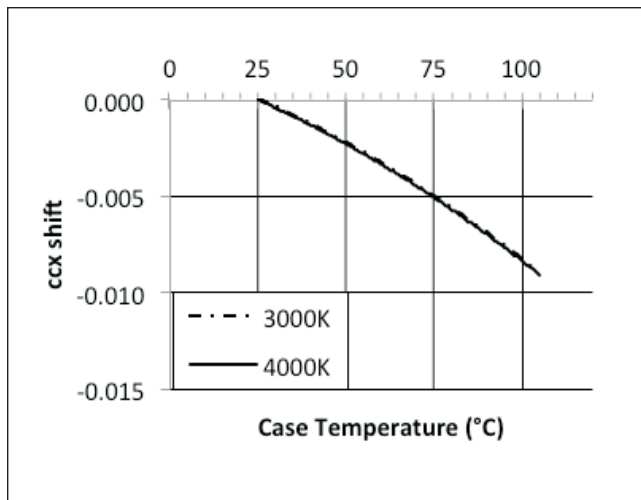
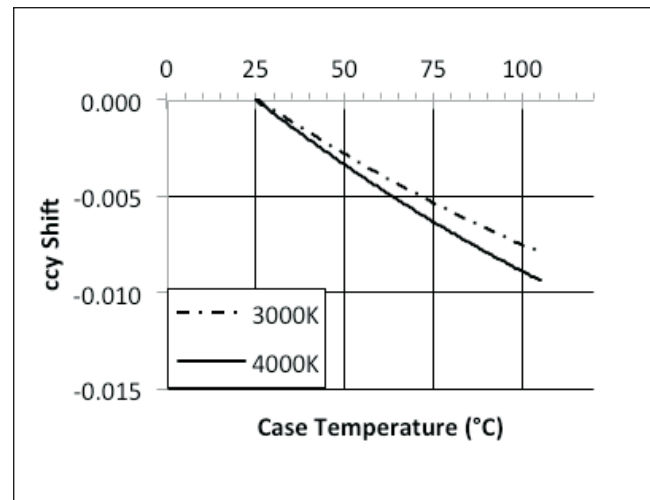


Figure 18: **Vero 13 Typical ccy Shift vs. Case Temperature**



Note for Figures 15-18:  
Flux measurements taken under DC conditions.



# Performance Curves

Figure 19: Vero 18 Typical ccx Shift vs. Case Temperature

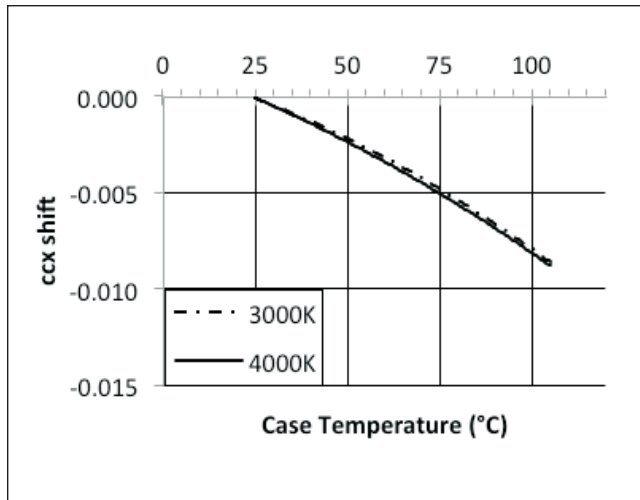


Figure 20: Vero 18 Typical ccy Shift vs. Case Temperature

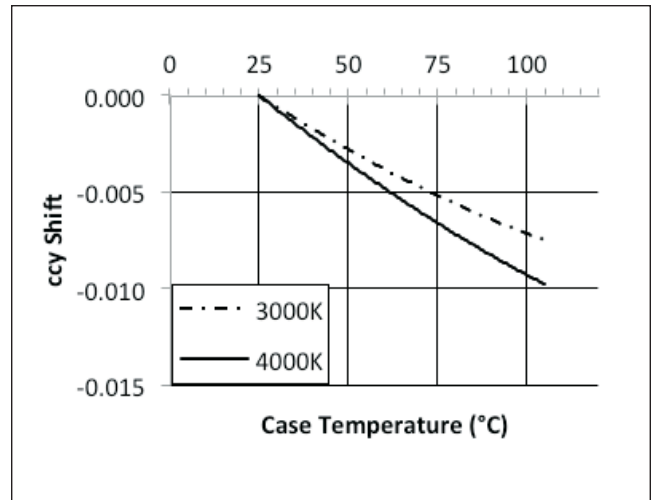


Figure 21: Vero 29 Typical ccx Shift vs. Case Temperature

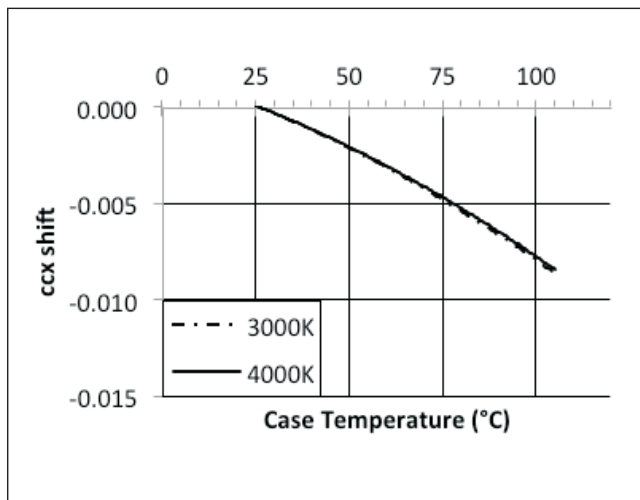
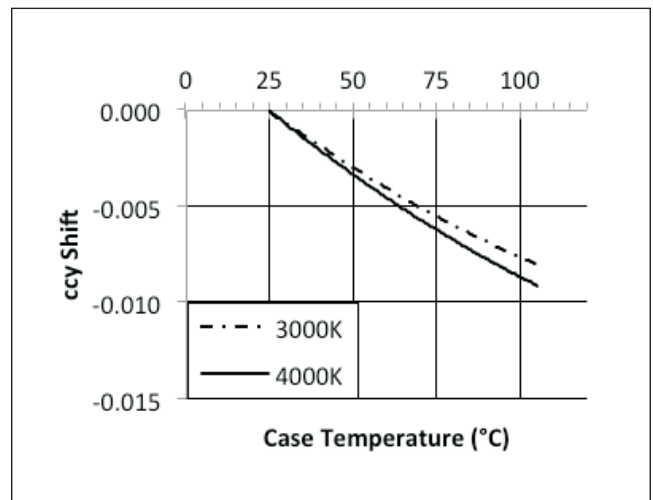


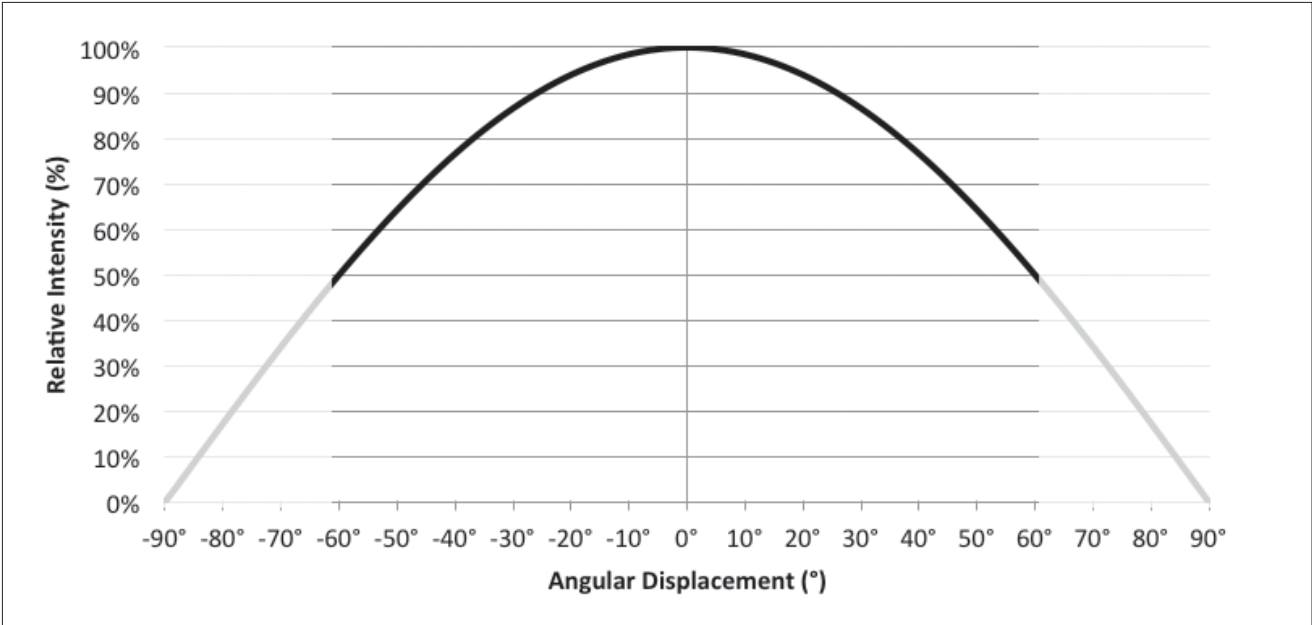
Figure 22: Vero 29 Typical ccy Shift vs. Case Temperature



Note for Figures 19-22:  
Flux measurements taken under DC conditions.

# Typical Radiation Pattern

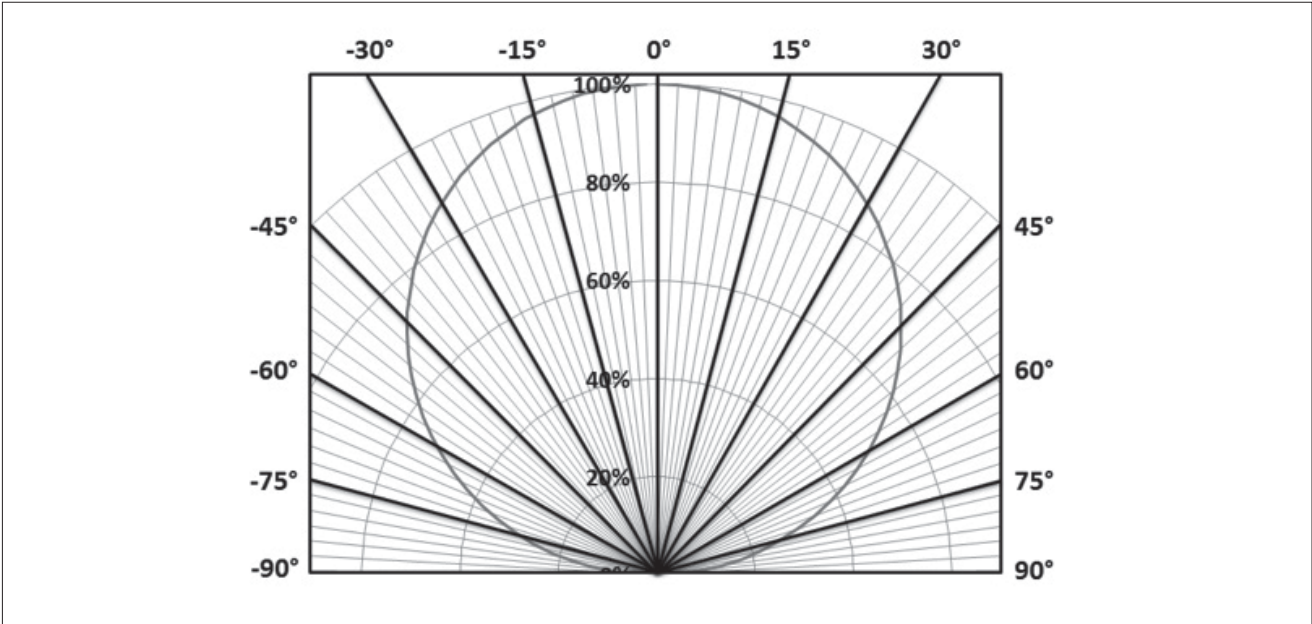
Figure 23: Typical Spatial Radiation Pattern



Notes for Figure 23:

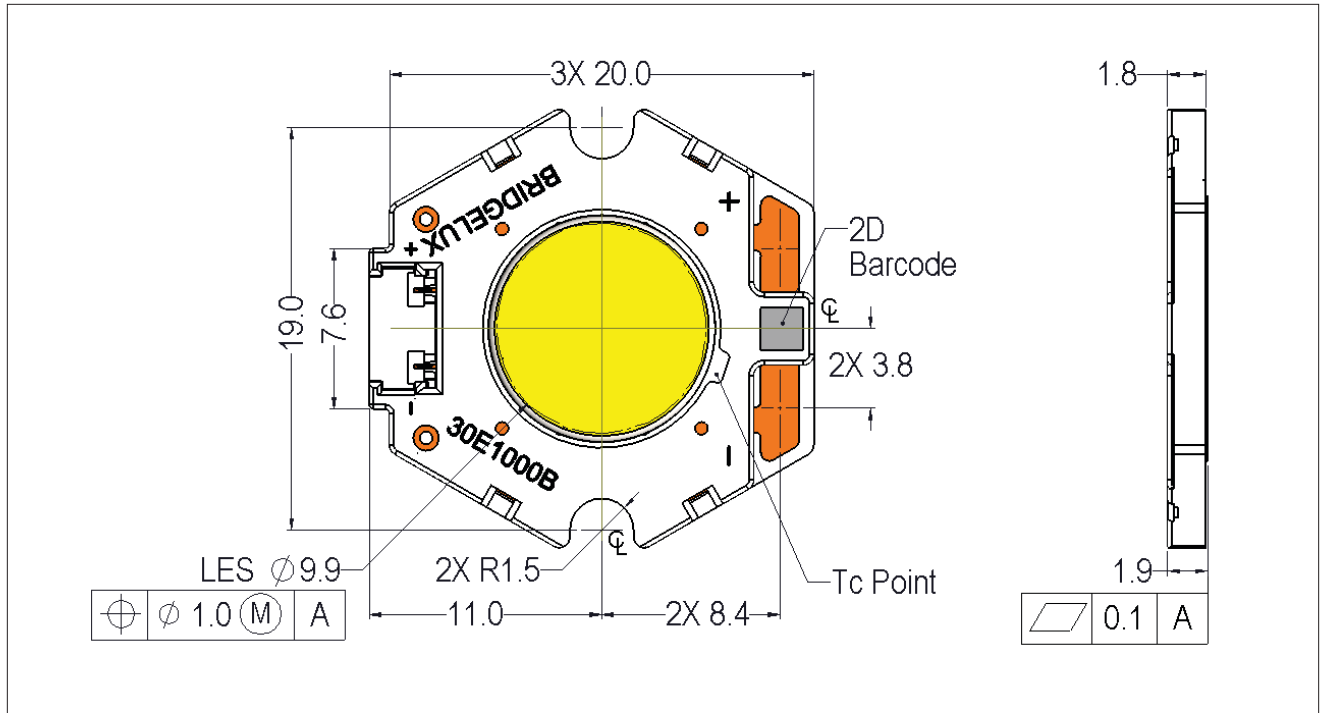
- 1. Typical viewing angle is 120°.
- 2. The viewing angle is defined as the off axis angle from the centerline where  $I_v$  is  $\frac{1}{2}$  of the peak value.

Figure 24: Typical Polar Radiation Pattern



# Mechanical Dimensions

**Figure 25: Drawing for Vero 10 LED Array**

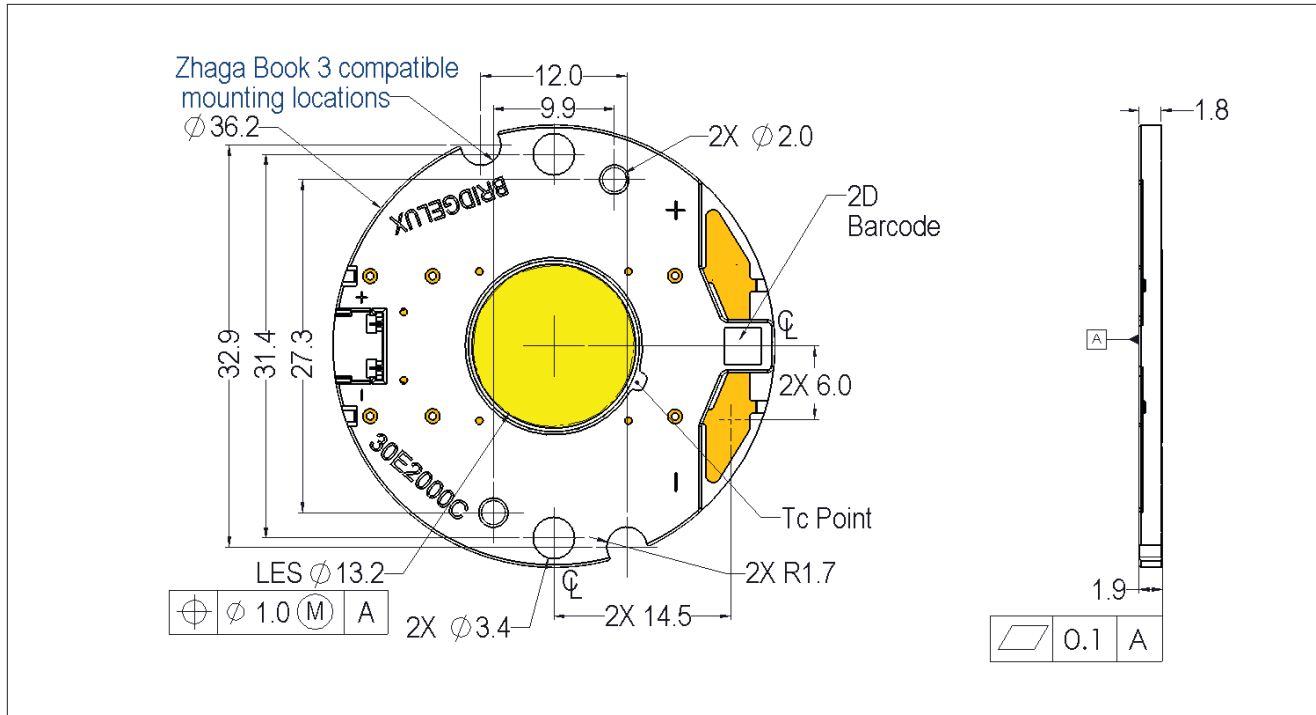


Notes for Figure 25:

1. Drawings are not to scale.
2. Drawing dimensions are in millimeters.
3. Unless otherwise specified, tolerances are  $\pm 0.01\text{mm}$ .
4. Mounting slots (2X) are for M2.5 screws.
5. Bridgelux recommends two tapped holes for mounting screws with  $19.0 \pm 0.10\text{mm}$  center-to-center spacing.
6. Screws with flat shoulders (pan, dome, button, round, truss, mushroom) provide optimal torque control. Do NOT use flat, countersink, or raised head screws.
7. Solder pads and connector port are labeled "+" and "-" to denote positive and negative, respectively.
8. It is not necessary to provide electrical connections to both the solder pads and the connector port. Either set may be used depending on application specific design requirements.
9. Refer to Application Notes AN30 and AN31 for product handling, mounting and heat sink recommendations.
10. The optical center of the LED Array is nominally defined by the mechanical center of the array to a tolerance of  $\pm 0.2\text{mm}$ .
11. Bridgelux maintains a flatness of 0.10mm across the mounting surface of the array.

# Mechanical Dimensions

**Figure 26: Drawing for Vero 13 LED Array**

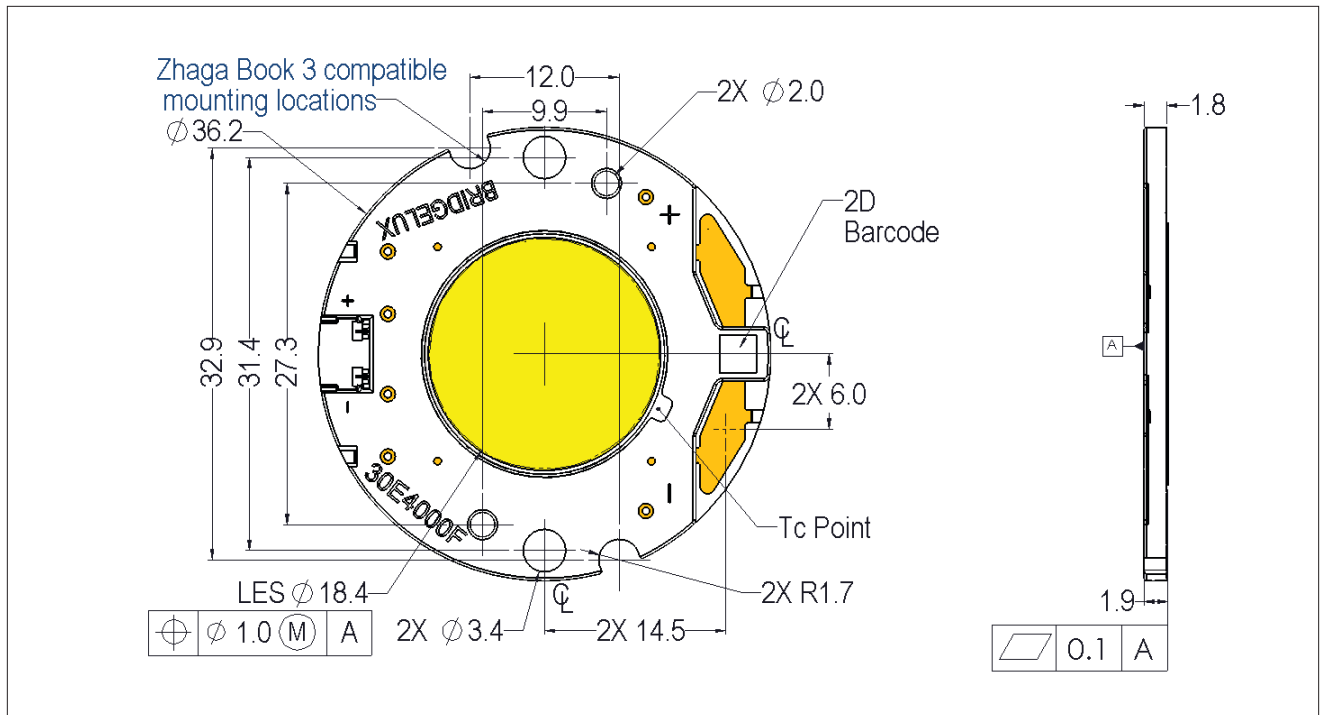


Notes for Figure 26:

1. Drawings are not to scale.
2. Drawing dimensions are in millimeters.
3. Unless otherwise specified, tolerances are  $\pm 0.01$ mm.
4. Mounting holes (2X) are for M2.5 screws.
5. Bridgelux recommends two tapped holes for mounting screws with  $31.4 \pm 0.10$ mm center-to-center spacing.
6. Screws with flat shoulders (pan, dome, button, round, truss, mushroom) provide optimal torque control. Do NOT use flat, countersink, or raised head screws.
7. Solder pads and connector port are labeled "+" and "-" to denote positive and negative, respectively.
8. It is not necessary to provide electrical connections to both the solder pads and the connector port. Either set may be used depending on application specific design requirements.
9. Refer to Application Notes AN30 and AN31 for product handling, mounting and heat sink recommendations.
10. The optical center of the LED Array is nominally defined by the mechanical center of the array to a tolerance of  $\pm 0.2$ mm.
11. Bridgelux maintains a flatness of  $0.10$ mm across the mounting surface of the array.

# Mechanical Dimensions

**Figure 27: Drawing for Vero 18 LED Array**

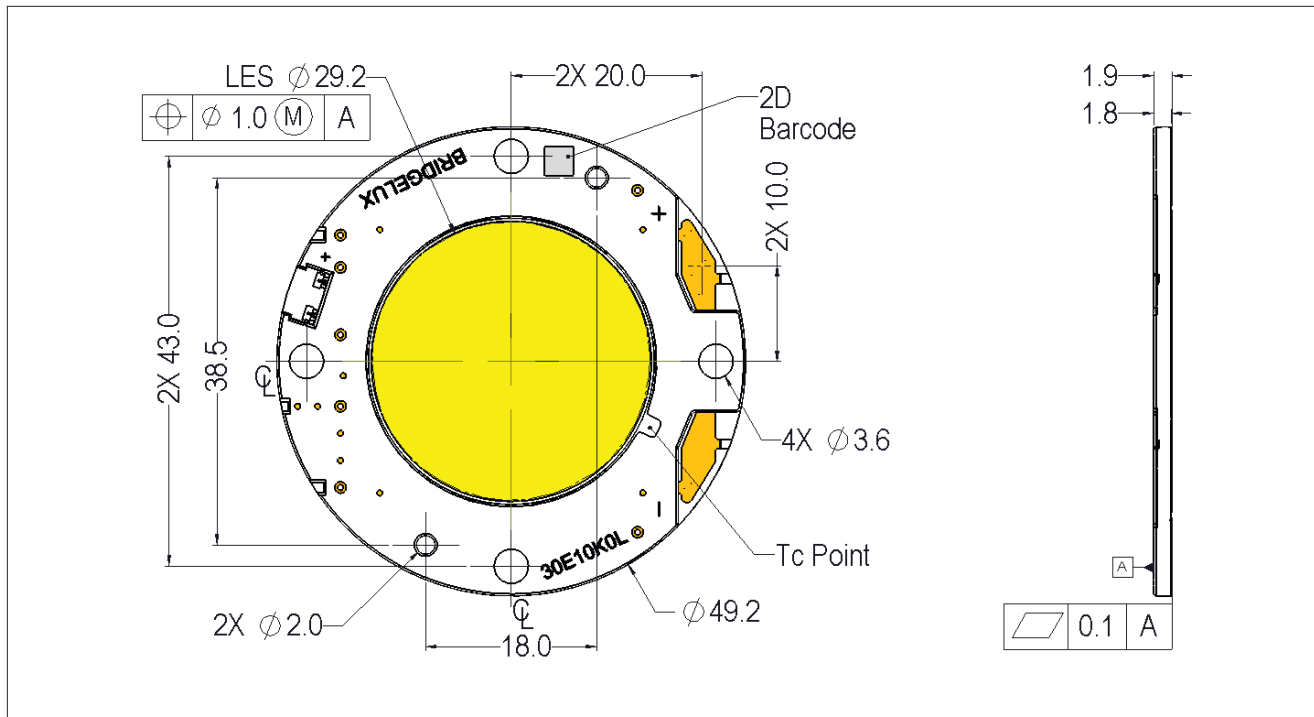


Notes for Figure 27:

1. Drawings are not to scale.
2. Drawing dimensions are in millimeters.
3. Unless otherwise specified, tolerances are  $\pm 0.01$ mm.
4. Mounting holes (2X) are for M2.5 screws.
5. Bridgelux recommends two tapped holes for mounting screws with  $31.4 \pm 0.10$ mm center-to-center spacing.
6. Screws with flat shoulders (pan, dome, button, round, truss, mushroom) provide optimal torque control. Do NOT use flat, countersink, or raised head screws.
7. Solder pads and connector port are labeled "+" and "-" to denote positive and negative, respectively.
8. It is not necessary to provide electrical connections to both the solder pads and the connector port. Either set may be used depending on application specific design requirements.
9. Refer to Application Notes AN30 and AN31 for product handling, mounting and heat sink recommendations.
10. The optical center of the LED Array is nominally defined by the mechanical center of the array to a tolerance of  $\pm 0.2$ mm.
11. Bridgelux maintains a flatness of  $0.10$ mm across the mounting surface of the array.

# Mechanical Dimensions

**Figure 28: Drawing for Vero 29 LED Array**

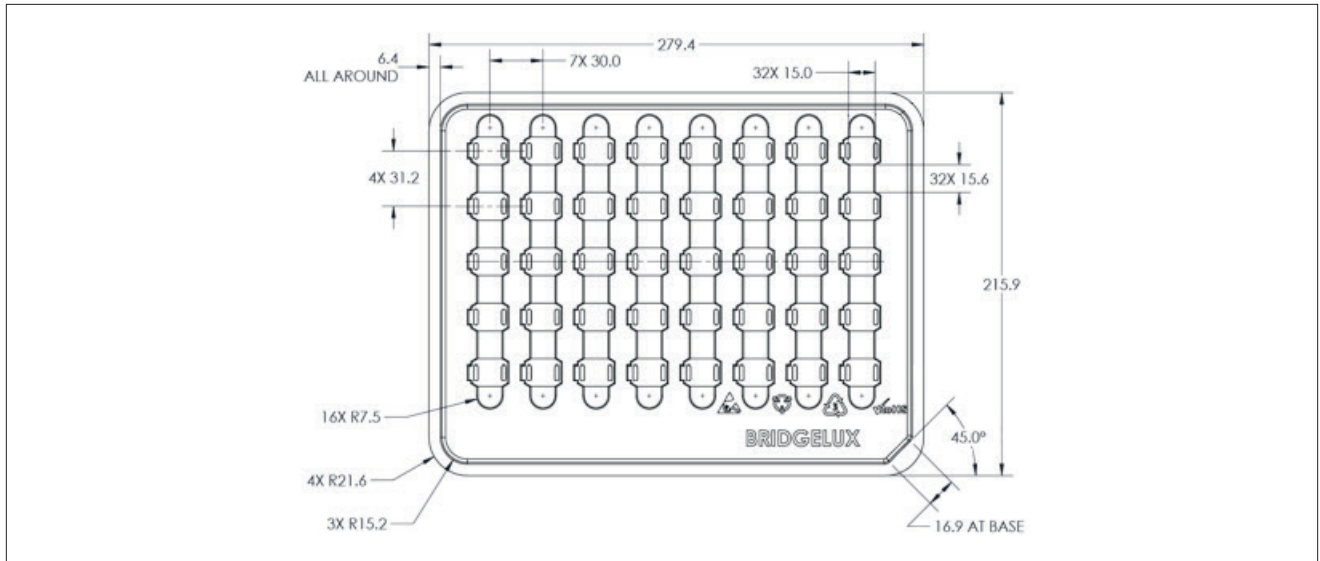


Notes for Figure 28:

1. Drawings are not to scale.
2. Drawing dimensions are in millimeters.
3. Unless otherwise specified, tolerances are  $\pm 0.01\text{mm}$ .
4. Mounting holes (2X) are for M2.5 screws.
5. Bridgelux recommends two tapped holes for mounting screws with  $31.4 \pm 0.10\text{mm}$  center-to-center spacing.
6. Screws with flat shoulders (pan, dome, button, round, truss, mushroom) provide optimal torque control. Do NOT use flat, countersink, or raised head screws.
7. Solder pads and connector port are labeled "+" and "-" to denote positive and negative, respectively.
8. It is not necessary to provide electrical connections to both the solder pads and the connector port. Either set may be used depending on application specific design requirements.
9. Refer to Application Notes AN30 and AN31 for product handling, mounting and heat sink recommendations.
10. The optical center of the LED Array is nominally defined by the mechanical center of the array to a tolerance of  $\pm 0.2\text{mm}$ .
11. Bridgelux maintains a flatness of  $0.10\text{mm}$  across the mounting surface of the array.

# Packaging

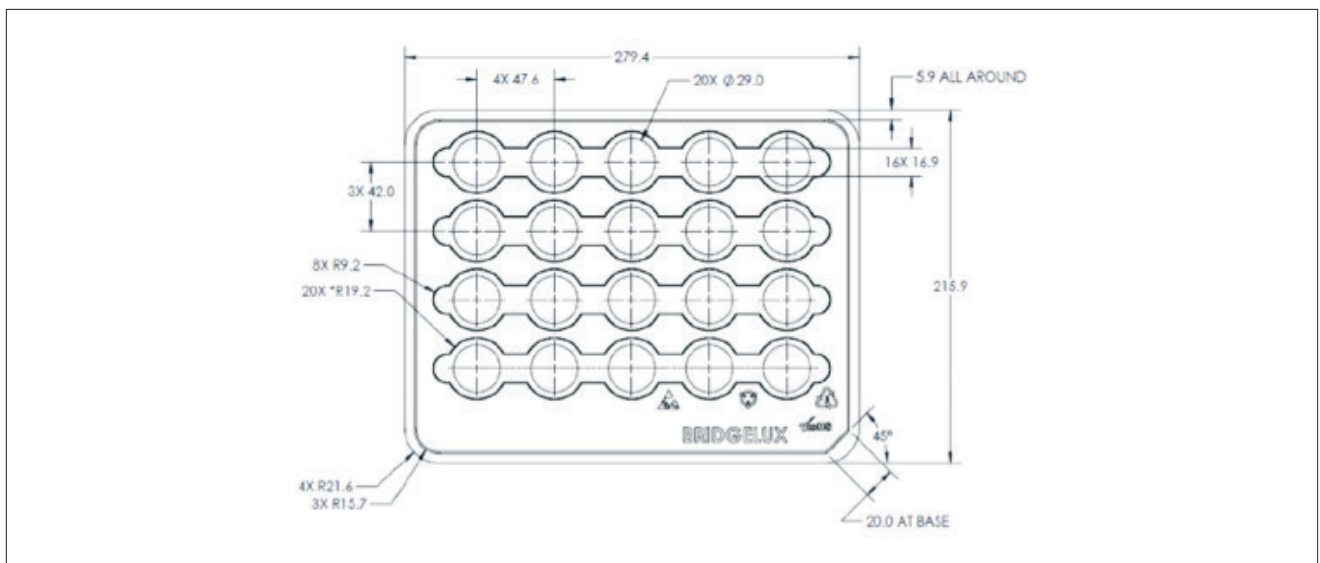
**Figure 29: Drawing for Vero 10 Packaging Tray**



Notes for Figure 29:

1. Dimensions are in millimeters
2. Tolerances: XX =  $\pm 0.1$ , XXX =  $\pm 0.05$ , Angles =  $\pm 1^\circ$
3. Trays are stackable without interference and will not stick together during unstacking operation.
4. Each tray holds 40 LEDs.

**Figure 30: Drawing for Vero 13 Packaging Tray**

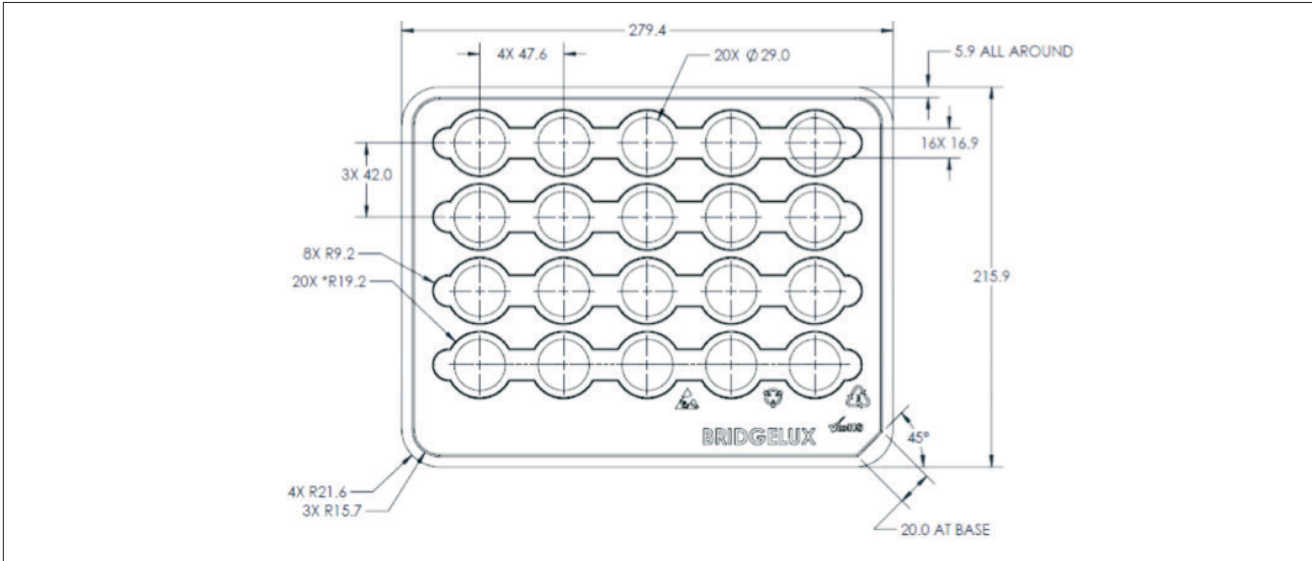


Notes for Figure 30:

1. Dimensions are in millimeters
2. Tolerances: XX =  $\pm 0.1$ , XXX =  $\pm 0.05$ , Angles =  $\pm 1^\circ$
3. Trays are stackable without interference and will not stick together during unstacking operation.
4. Each tray holds 20 LEDs.

# Packaging

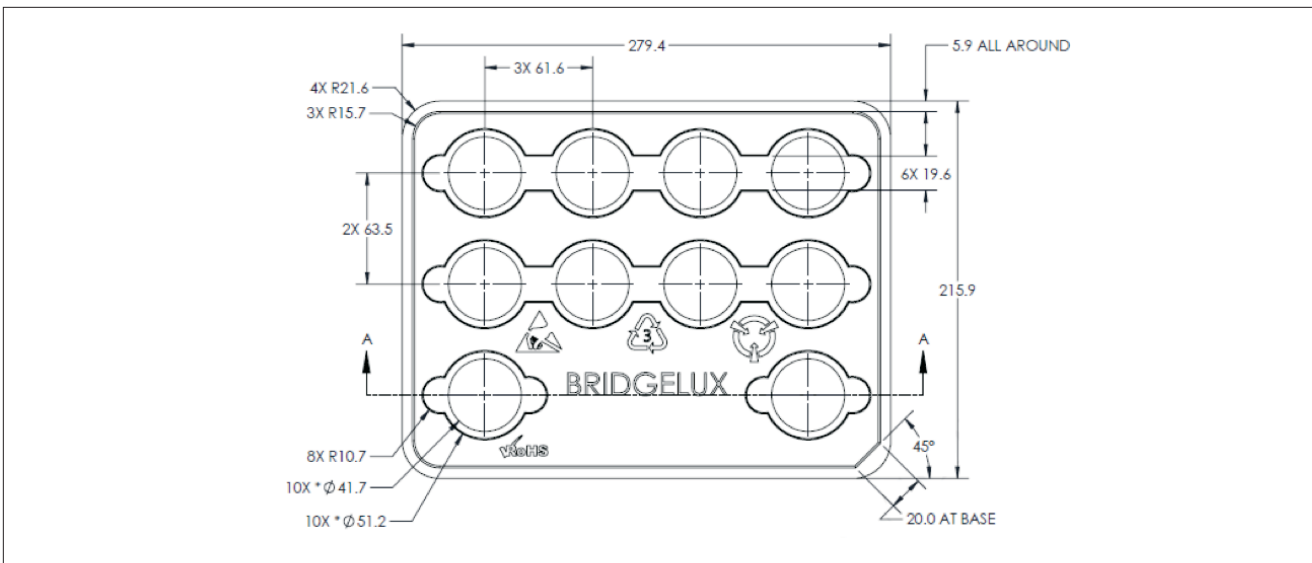
**Figure 31: Drawing for Vero 18 Packaging Tray**



Notes for Figure 31:

1. Dimensions are in millimeters
2. Tolerances: XX = ± 0.1, XXX = ± 0.05, Angles = ± 1°
3. Trays are stackable without interference and will not stick together during unstacking operation
4. Each tray holds 20 LEDs.

**Figure 32: Drawing for Vero 29 Packaging Tray**



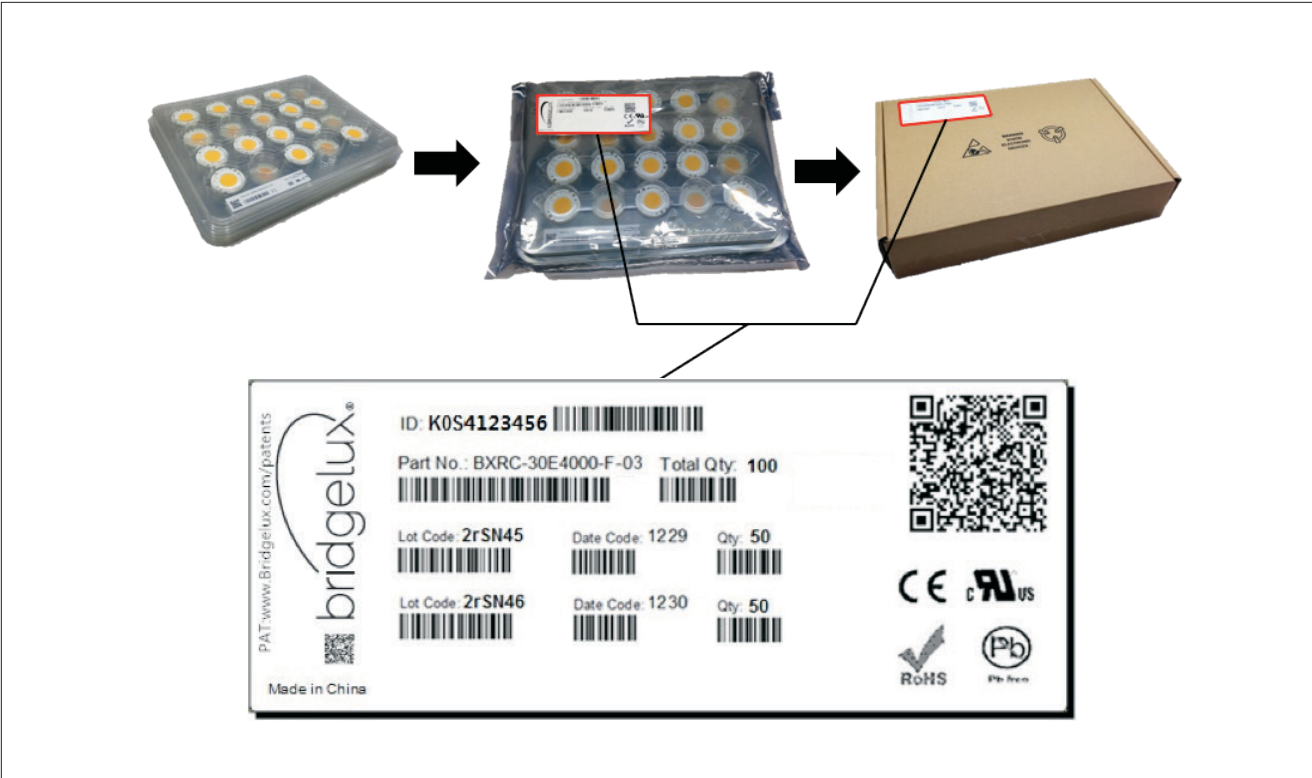
Notes for Figure 32:

1. Dimensions are in millimeters
2. Tolerances: XX = ± 0.1, XXX = ± 0.05, Angles = ± 1°
3. Trays are stackable without interference and will not stick together during unstacking operation
4. Each tray holds 10 LEDs.



# Packaging

Figure 33: Vero Series Packaging and Labeling



Notes for Figure 33:

- 1. 5 trays are stacked and one empty tray placed on top to cover the top tray.
- 2. Stacked trays are to contain only 1 part number and be vacuum sealed in an anti-static bag and placed in own box.
- 3. Each bag and box is to be labeled as shown above.

# Design Resources

## Application Notes

Bridgelux has developed a comprehensive set of application notes and design resources to assist customers in successfully designing with the Vero product family of LED array products. For a list of resources under development, visit [www.bridgelux.com](http://www.bridgelux.com).

## Optical Source Models

Optical source models and ray set files are available for all Bridgelux products. For a list of available formats, visit [www.bridgelux.com](http://www.bridgelux.com).

## 3D CAD Models

Three dimensional CAD models depicting the product outline of all Bridgelux Vero LED arrays are available in both SAT and STEP formats. Please contact your Bridgelux sales representative for assistance.

# Precautions

## CAUTION: CHEMICAL EXPOSURE HAZARD

Exposure to some chemicals commonly used in luminaire manufacturing and assembly can cause damage to the LED array. Please consult Bridgelux Application Note AN31 for additional information.

## CAUTION: EYE SAFETY

Eye safety classification for the use of Bridgelux Vero LED arrays is in accordance with IEC specification EN62471: Photobiological Safety of Lamps and Lamp Systems. Vero LED arrays are classified as Risk Group 1 (Low Risk) when operated at or below the maximum drive current. Please use appropriate precautions. It is important that employees working with LEDs are trained to use them safely.

## CAUTION: RISK OF BURN

Do not touch the Vero LED array or yellow resin area during operation. Allow the array to cool for a sufficient period of time before handling. The Vero LED array may reach elevated temperatures such that could burn skin when touched.

## CAUTION

### CONTACT WITH LIGHT EMITTING SURFACE (LES)

Avoid any contact with the LES. Do not touch the LES of the LED array or apply stress to the LES (yellow phosphor resin area). Contact may cause damage to the LED array.

Optics and reflectors must not be mounted in contact with the LES (yellow phosphor resin area). Optical devices may be mounted on the top surface of the plastic housing of the Vero LED array. Use the mechanical features of the LED array housing, edges and/or mounting holes to locate and secure optical devices as needed.

# Disclaimers

## MINOR PRODUCT CHANGE POLICY

The rigorous qualification testing on products offered by Bridgelux provides performance assurance. Slight cosmetic changes that do not affect form, fit, or function may occur as Bridgelux continues product optimization.

## STANDARD TEST CONDITIONS

Unless otherwise stated, array testing is performed at the nominal drive current.

# About Bridgelux

Bridgelux is a leading developer and manufacturer of technologies and solutions transforming the \$40 billion global lighting industry into a \$100 billion market opportunity. Based in Livermore, California, Bridgelux is a pioneer in solid state lighting (SSL), expanding the market for light emitting diode (LED) technologies by driving down the cost of LED lighting systems. Bridgelux's patented light source technology replaces traditional technologies (such as incandescent, halogen, fluorescent and high intensity discharge lighting) with integrated, solid state lighting solutions that enable lamp and luminaire manufacturers to provide high performance and energy efficient white light for the rapidly growing interior and exterior lighting markets, including street lights, commercial lighting and consumer applications.

**For more information about the company,  
please visit [bridgelux.com](http://bridgelux.com).**



101 Portola Avenue  
Livermore, CA 94551  
Tel (925) 583-8400  
Fax (925) 583-8410  
[www.bridgelux.com](http://www.bridgelux.com)

© 2015 Bridgelux, Inc. All rights reserved 2014. Product specifications are subject to change without notice. Bridgelux, the Bridgelux stylized logo design and Vero are registered trademarks, and Decor Series is a trademark of Bridgelux, Inc. All other trademarks are the property of their respective owners.

Bridgelux Vero Decor Series Product Data Sheet DS35 Rev. A (03/2015)