

KEMET Part Number: LDEPF3100KA0N00
(DEPF3100KA0N00)

Capacitor, film, 0.1 uF, +/-10% Tol, General Purpose, 630 VDC@125C

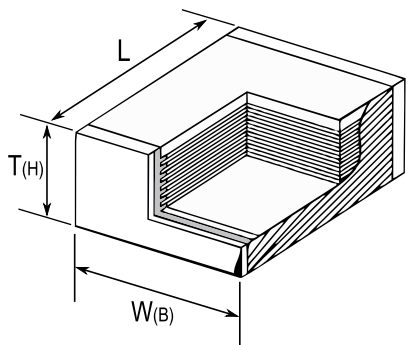

Note: '()' correspond to the letters used in the product bulletin

Dimensions (mm)		
Symbol	Dimension	Tolerance
L	10.5	+/-0.4
W	7.9	+/-0.5
T	5.5	MAX

Packaging Specifications	
Package Kind:	T&R
Package Size:	Standard
Package Quantity:	1000

General Information	
Supplier:	KEMET
Dielectric:	Metallized PEN (Stacked)
Application:	General Purpose
Sub Application:	AEC-Q200
Style:	Surface Mount
Chip Size:	4030
RoHS:	Yes

Specifications	
Capacitance:	0.1 uF
Voltage:	630 VDC
Tolerance:	+/-10%
Voltage AC:	200 VAC
Rated Temperature:	125C
Temperature Range:	-55/+125C
Dissipation Factor @ 1 kHz:	0.8%
Insulation Resistance:	1 GOhm
Maximum dVdT:	100 v/us