

13~17 A Compatible, Position Misalignment Absorption Type Power Supply Connector for PCB Connections

FX30B Series

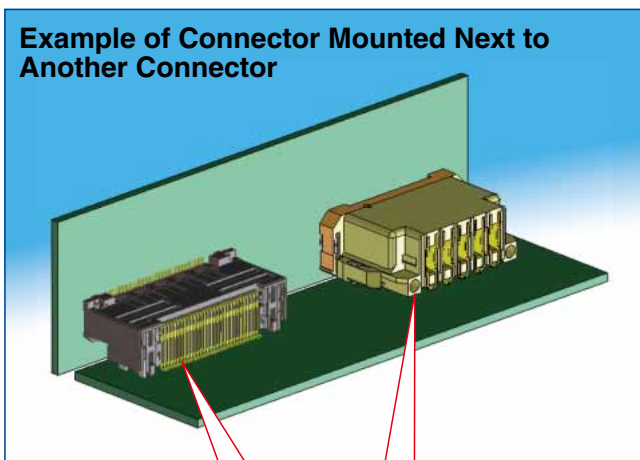

FX18 Series
(without position misalignment absorption function)

FX30B Series
(with position misalignment absorption function)

■ Features

1. **Contact Pitch: 3.81 mm**
2. **Current Capacity: 13~17 A/pin (Page 2.)**
*For details, see the derating curve.(Described on page 4.)
3. **Connection Type: Coplanar / Vertical / Parallel**
4. **Number of Pos.: 2 / 3 / 4 / 5 Pos.**
5. **Position Misalignment Absorption Movable Amount: ±0.3 mm**
 - (1)Reliable to mounting misalignment when using multiple connectors.
 - (2)Other products without position misalignment absorption can be used together.
6. **Effective Mating Length: 2 mm**
The effective mating length is 2 mm long, so it has an enough margin for the mating stroke. (3.0 mm for longer contacts)
7. **Multi-point Contact Structure**
It has superior contact reliability by employing an independent four-point contact spring structure.
8. **Low Insertion / Extraction Force**
It offers low insertion/extraction force by employing a two-step contact timing sequence.
9. **Robustness**
Reinforcement metal fittings that securely fix the connector to the PCB are added on both sides of the connector, providing excellent deformation resistance for up, down, left and right directions.
10. **Large Guide Form Leads Superior Mating Ability**
A large induction form has been provided, allowing easy mating operations. (Induction amount: ±1.3 mm, with position misalignment absorption amount: ±1.6 mm)
11. **Protected structure**
Our proprietary protective wall prevents foreign materials from contacting the sensitive areas. (Compatible to JIS C 0922 Probes for verification B)
12. **UL, C-UL and TÜV certifications have been achieved.**

■ Mating variations

Coplanar connection type

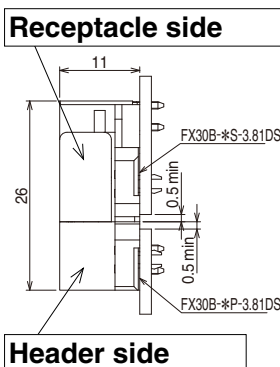

Vertical connection type A

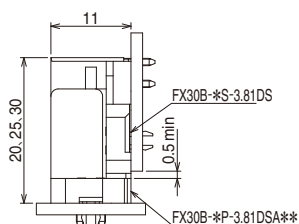

Vertical connection type B

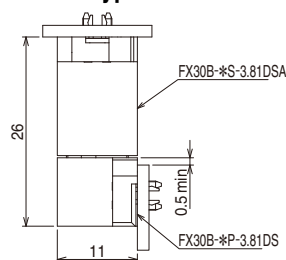

Parallel connection type

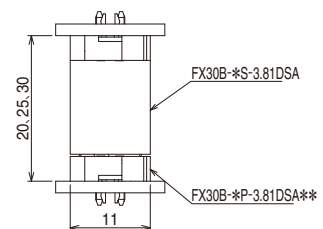

Product Specifications

| | | 2 pos. | 3 pos. | 4 pos. | 5 pos. | Operating temperature range: -55 to 105°C (Note 1) |
|-------------------------------|-------------------------|----------------|---------------------|---|------------|--|
| Ratings | Current rating (Note 3) | UL/C-UL TÜV | 16A 17A | 15A 16A | 13A 15A | Operating humidity range: Relative humidity 85% max. (Not dewed) |
| | Voltage rating | UL/C-UL TÜV | 250V AC/DC | | 150V AC/DC | |
| File No. and Confirmation No. | | UL/C-UL TÜV | E52653 R50275872 | (Acc. to UL1977 / CSA C22.2 No.182.3-M1987) (Acc. to EN61984:2009) | | |

| Item | Specification | Conditions |
|----------------------------------|--|---|
| 1. Contact resistance | 2 mΩ or less | Measured at 10 mA |
| 2. Insulation resistance | 1000 MΩ or more | Measured at 250 V DC |
| 3. Withstanding voltage | No flashover or breakdown | Conduct electricity by applying a voltage of 750 V AC for 1 minute |
| 4. Insertion/extraction lifespan | Contact resistance: 5 mΩ or less | Insert/extract 100 times |
| 5. Vibration resistance | No electric outage of 1μs or greater | Frequency: 10 to 55 Hz, half amplitude: 0.75 mm, 10 cycles in each of 3 axis directions for 5 minutes/cycle |
| 6. Shock resistance | No electric outage of 1μs or greater | Acceleration of 490 m/s ² , duration 11 ms, sine half-wave, 3 cycles in each of the 3 axes each in both directions |
| 7. Humidity resistance | Contact resistance: 5 mΩ or less Insulation resistance: 1000 MΩ or more | Temperature: 40°C, humidity: 90 to 95%, left for 96 hours |
| 8. Temperature cycle | Contact resistance: 5 mΩ or less Insulation resistance: 1000 MΩ or more | Temperature: -55 → 105°C Time: 30 → 30 min., 5 cycles |
| 9. Solder heat resistance | No melting of resin part, which affects the product performance | Solder tank: solder tank temperature: 260°C, 10 seconds Manual soldering: soldering iron temperature: 380°C, 10 seconds |

(Note 1) Includes temperature rise caused by current flow.

(Note 2) The term “storage” refers to the long-term storage condition of unused products before PCB mounting.

(Note 3) Current rating per 1 contact is used.

Materials

●Receptacle/Header Common

| Part | Material | Color/Treatment | Specification |
|-----------------------------|--------------------|---|---------------|
| Insulator | Polyamide resin | Black | UL94V-0 |
| Power supply contact | Copper alloy | Contact area: Gold plating Mounting area: Pure tin plating | — |
| Reinforcement metal fitting | Phosphorous bronze | Whole body: Pure tin plating | — |

Product Number Structure

Refer to this page when judging product specifications by model types. When making an order, please select a model type described in this catalog.

●Receptacle

FX30B - 5 S - 3.81 DS

① ② ③ ④ ⑤

●Header

FX30B - 5 P - 3.81 DSA 20

① ② ③ ④ ⑤ ⑥

| | |
|------------------------|--|
| ① Series Name | FX30B |
| ② Number of Contacts | 2 to 5 |
| ③ Connector Type | S: Receptacle type P: Header type |
| ④ Contact Pitch | 3.81mm |
| ⑤ Product Type | DS: Right angle type DSA: Straight type |
| ⑥ Stacking Height Type | |

Functional diagram

● Right angle receptacle

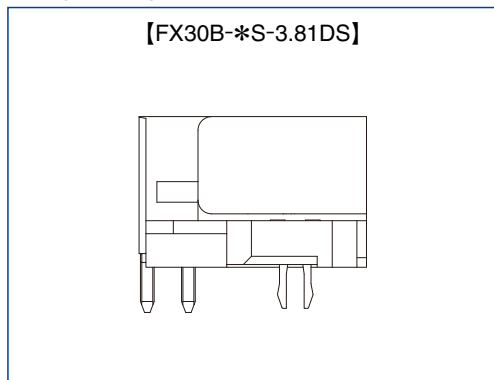

● Right angle header

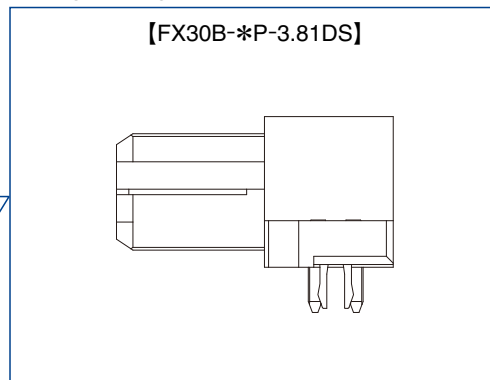

Coplanar connection

Vertical connection

● Straight receptacle

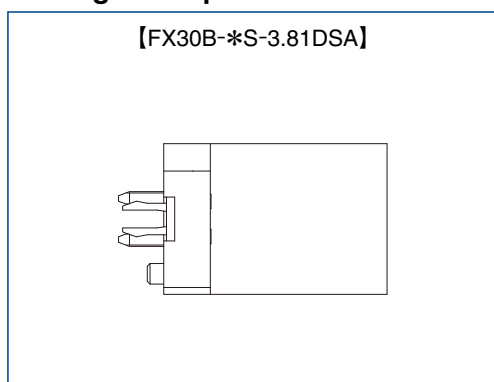

● Straight header

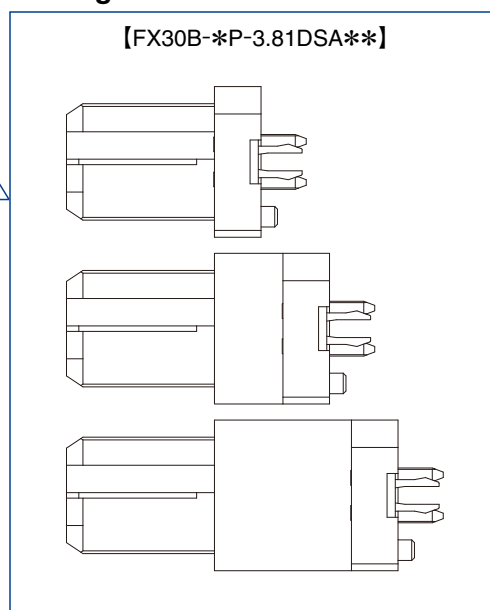

Parallel connection

Note !

The FX30A and FX30B series connectors are two independent series and are not compatible. Do not try to cross mate them as they do NOT have mating compatibilities.

Stacking height dimensions for parallel connection type

Stacking height combinations table

| | FX30B-*P-3.81DSA20 | FX30B-*P-3.81DSA25 | FX30B-*P-3.81DSA30 |
|------------------|--------------------|--------------------|--------------------|
| FX30B-*S-3.81DSA | 20mm | 25mm | 30mm |

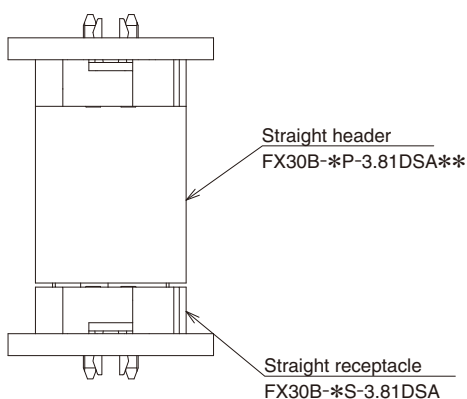

Derating curve

(Electricity conducted through the 5 pins of 5-pin coplanar connection type connector)

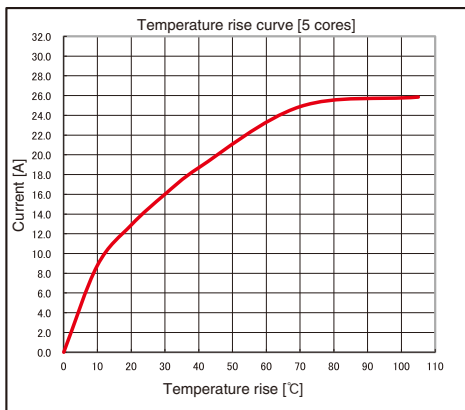
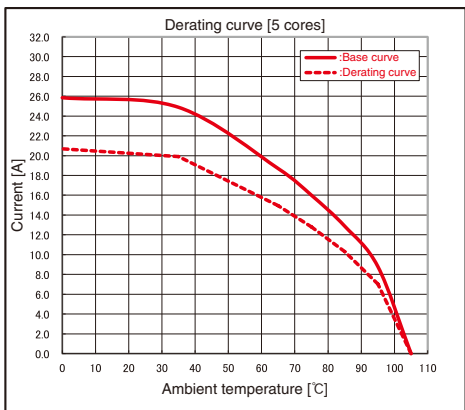

(Electricity conducted through the 4 pins of 4-pin coplanar connection type connector)

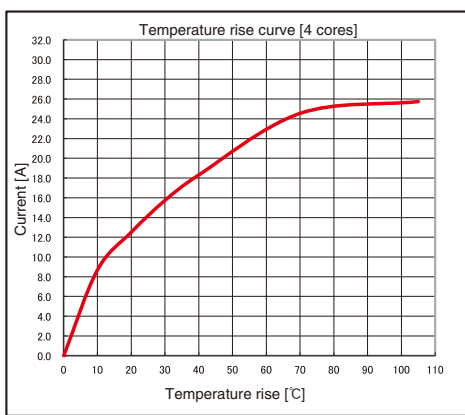
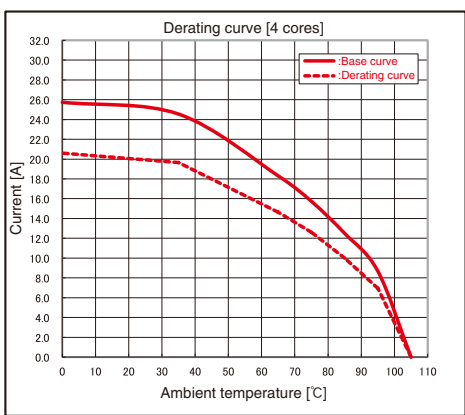

(Electricity conducted through the 3 pins of 3-pin coplanar connection type connector)

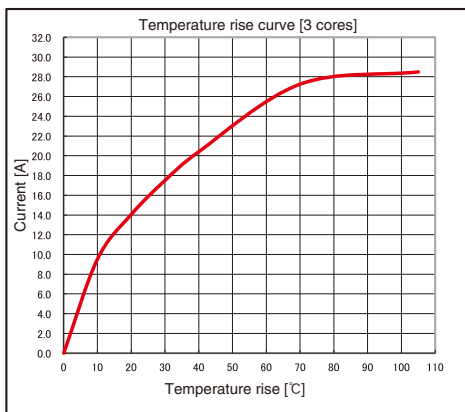
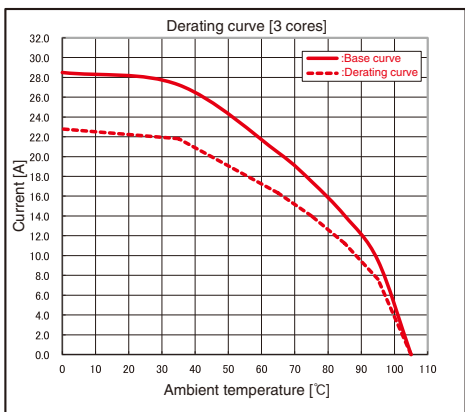

(Electricity conducted through the 2 pins of 2-pin coplanar connection type connector)

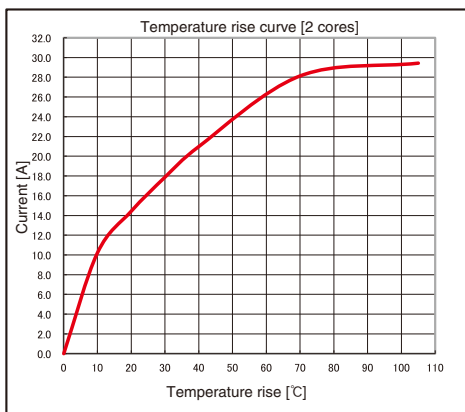
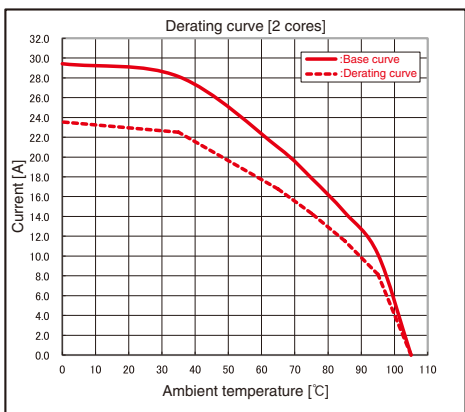

Note: The derating curve is created by multiplying a derating factor of 0.8 to the current value of the base curve.

●Right angle receptacle (S-DS type)

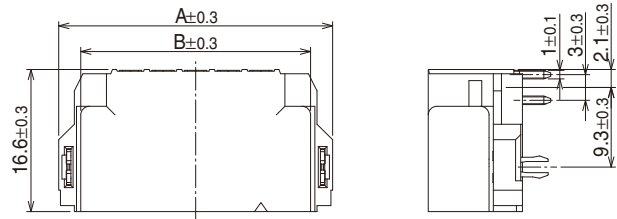

◆Diagram of recommended PCB layout dimensions

(Note) PCB thickness: $t = 1.6 \text{ mm}$

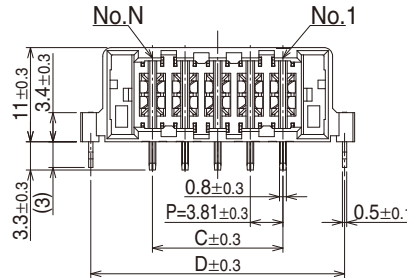
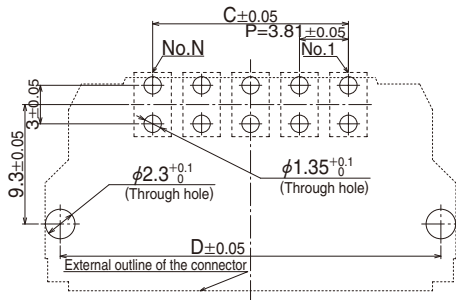

Unit: mm

| Product No. | HRS No. | A | B | C | D | N (No. of Contacts) |
|-----------------|------------------|-------|-------|-------|-------|---------------------|
| FX30B-2S-3.81DS | CL0570-3600-6-00 | 20.56 | 15.41 | 3.81 | 18.21 | 2 |
| FX30B-3S-3.81DS | CL0570-3601-9-00 | 24.37 | 19.22 | 7.62 | 22.02 | 3 |
| FX30B-4S-3.81DS | CL0570-3602-1-00 | 28.18 | 23.03 | 11.43 | 25.83 | 4 |
| FX30B-5S-3.81DS | CL0570-3603-4-00 | 31.99 | 26.84 | 15.24 | 29.64 | 5 |

●Straight receptacle (S-DSA type)

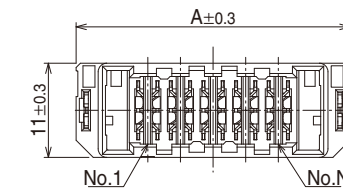

◆Diagram of recommended PCB layout dimensions

(Note) PCB thickness: $t = 1.6 \text{ mm}$

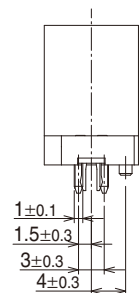
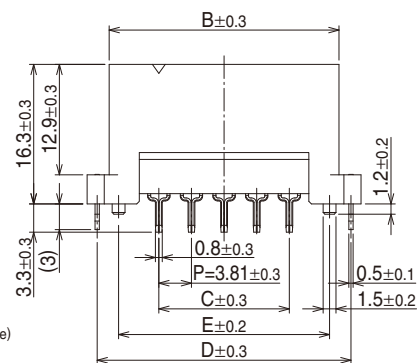
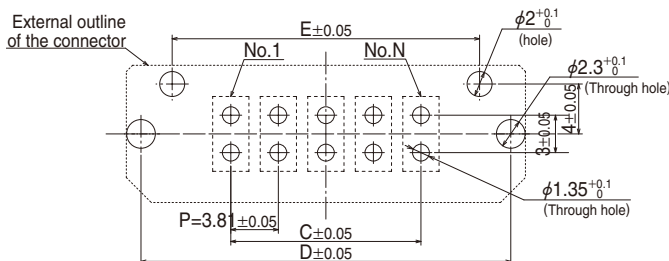

Unit: mm

| Product No. | HRS No. | A | B | C | D | E | N (No. of Contacts) |
|------------------|------------------|-------|-------|-------|-------|-------|---------------------|
| FX30B-2S-3.81DSA | CL0570-3500-1-00 | 20.56 | 15.41 | 3.81 | 18.21 | 13.21 | 2 |
| FX30B-3S-3.81DSA | CL0570-3501-4-00 | 24.37 | 19.22 | 7.62 | 22.02 | 17.02 | 3 |
| FX30B-4S-3.81DSA | CL0570-3502-7-00 | 28.18 | 23.03 | 11.43 | 25.83 | 20.83 | 4 |
| FX30B-5S-3.81DSA | CL0570-3503-0-00 | 31.99 | 26.84 | 15.24 | 29.64 | 24.64 | 5 |

● Right angle header (P-DS type)

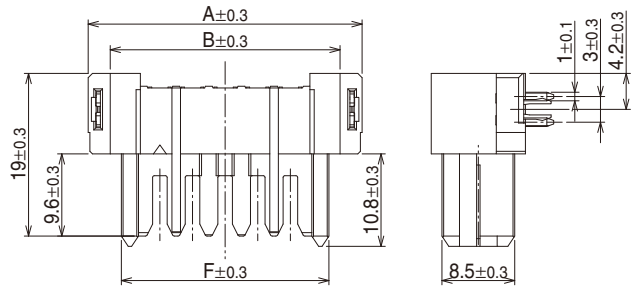

◆ Diagram of recommended PCB layout dimensions

(Note) PCB thickness: t= 1.6 mm

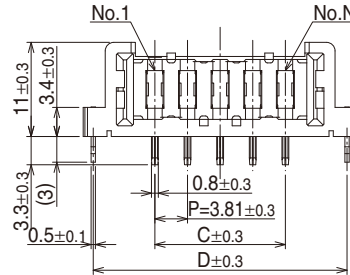
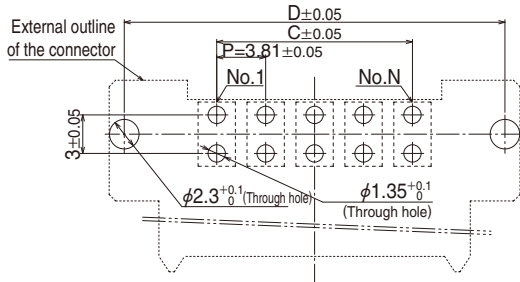

Unit: mm

| Product No. | HRS No. | A | B | C | D | F | N (No. of Contacts) |
|-----------------|------------------|-------|-------|-------|-------|-------|---------------------|
| FX30B-2P-3.81DS | CL0570-3400-7-00 | 20.56 | 15.41 | 3.81 | 18.21 | 12.81 | 2 |
| FX30B-3P-3.81DS | CL0570-3401-0-00 | 24.37 | 19.22 | 7.62 | 22.02 | 16.62 | 3 |
| FX30B-4P-3.81DS | CL0570-3402-2-00 | 28.18 | 23.03 | 11.43 | 25.83 | 20.43 | 4 |
| FX30B-5P-3.81DS | CL0570-3403-5-00 | 31.99 | 26.84 | 15.24 | 29.64 | 24.24 | 5 |

● Straight header - 20 (P-DSA20 type)

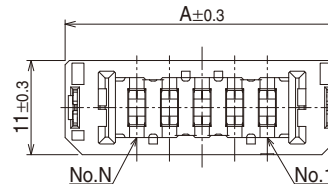
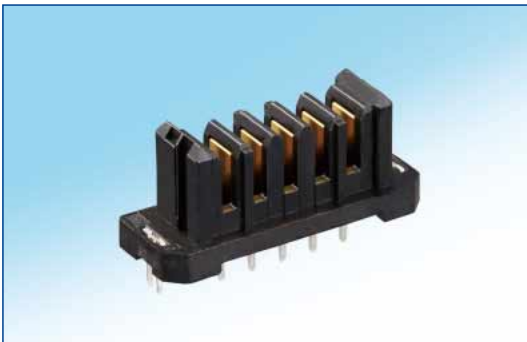

◆ Diagram of recommended PCB layout dimensions

(Note) PCB thickness: t= 1.6 mm

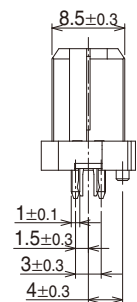
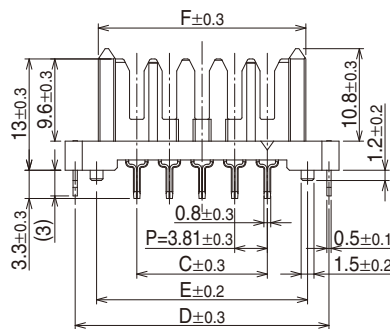
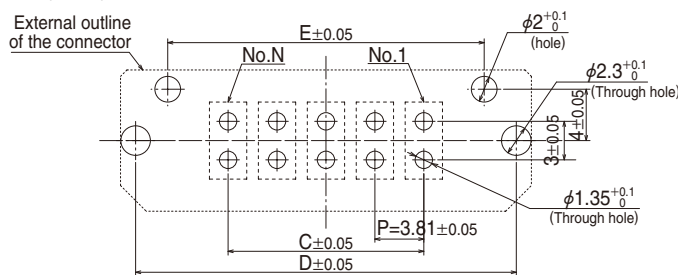

Unit: mm

| Product No. | HRS No. | A | C | D | E | F | N (No. of Contacts) |
|--------------------|------------------|-------|-------|-------|-------|-------|---------------------|
| FX30B-2P-3.81DSA20 | CL0570-3100-3-00 | 20.56 | 3.81 | 18.21 | 13.21 | 12.81 | 2 |
| FX30B-3P-3.81DSA20 | CL0570-3101-6-00 | 24.37 | 7.62 | 22.02 | 17.02 | 16.62 | 3 |
| FX30B-4P-3.81DSA20 | CL0570-3102-9-00 | 28.18 | 11.43 | 25.83 | 20.83 | 20.43 | 4 |
| FX30B-5P-3.81DSA20 | CL0570-3103-1-00 | 31.99 | 15.24 | 29.64 | 24.64 | 24.24 | 5 |

●Straight header - 25 (P-DSA25 type)

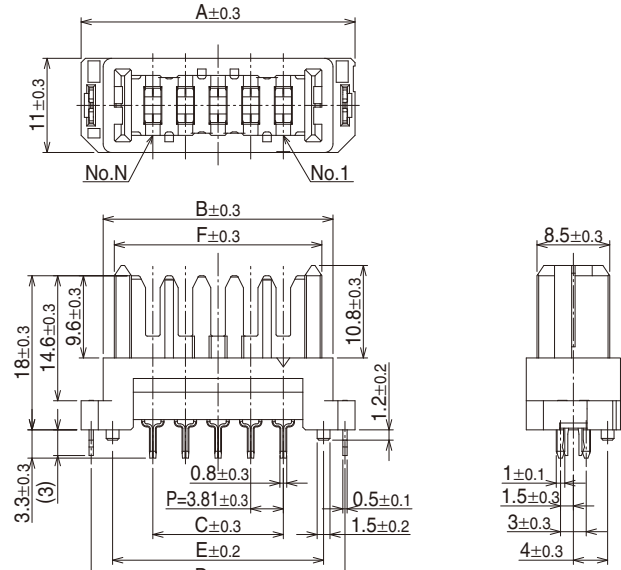
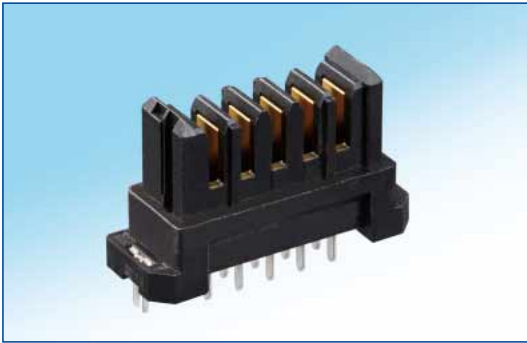

◆Diagram of recommended PCB layout dimensions

(Note) PCB thickness: $t = 1.6 \text{ mm}$

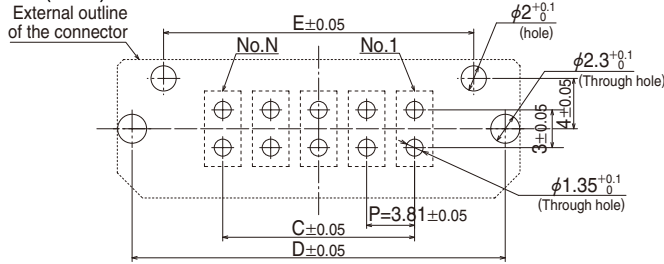

Unit: mm

| Product No. | HRS No. | A | B | C | D | E | F | N (No. of Contacts) |
|--------------------|------------------|-------|-------|-------|-------|-------|-------|---------------------|
| FX30B-2P-3.81DSA25 | CL0570-3200-8-00 | 20.56 | 15.41 | 3.81 | 18.21 | 13.21 | 12.81 | 2 |
| FX30B-3P-3.81DSA25 | CL0570-3201-0-00 | 24.37 | 19.22 | 7.62 | 22.02 | 17.02 | 16.62 | 3 |
| FX30B-4P-3.81DSA25 | CL0570-3202-3-00 | 28.18 | 23.03 | 11.43 | 25.83 | 20.83 | 20.43 | 4 |
| FX30B-5P-3.81DSA25 | CL0570-3203-6-00 | 31.99 | 26.84 | 15.24 | 29.64 | 24.64 | 24.24 | 5 |

●Straight header - 30 (P-DSA30 type)

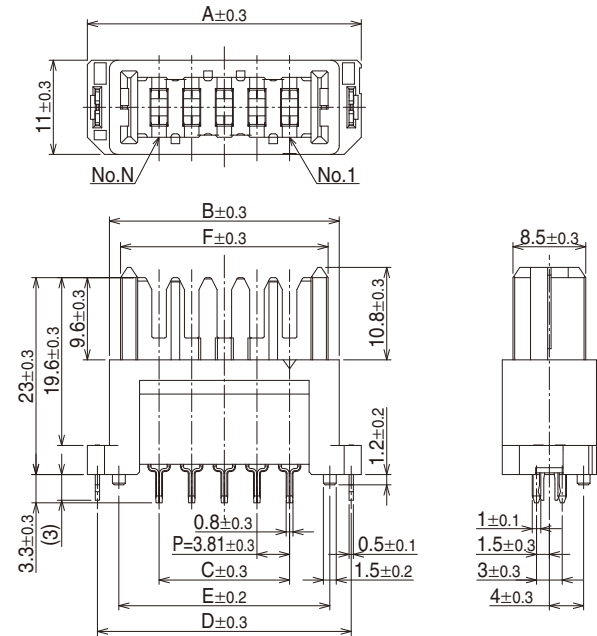

◆Diagram of recommended PCB layout dimensions

(Note) PCB thickness: $t = 1.6 \text{ mm}$

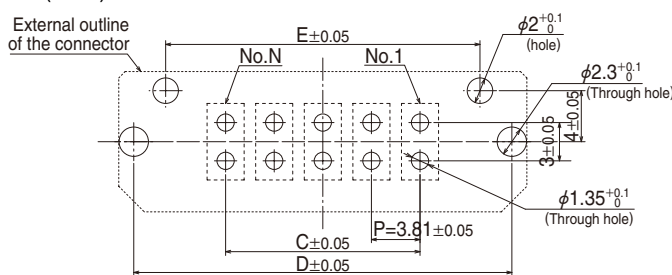

Unit: mm

| Product No. | HRS No. | A | B | C | D | E | F | N (No. of Contacts) |
|--------------------|------------------|-------|-------|-------|-------|-------|-------|---------------------|
| FX30B-2P-3.81DSA30 | CL0570-3300-2-00 | 20.56 | 15.41 | 3.81 | 18.21 | 13.21 | 12.81 | 2 |
| FX30B-3P-3.81DSA30 | CL0570-3301-5-00 | 24.37 | 19.22 | 7.62 | 22.02 | 17.02 | 16.62 | 3 |
| FX30B-4P-3.81DSA30 | CL0570-3302-8-00 | 28.18 | 23.03 | 11.43 | 25.83 | 20.83 | 20.43 | 4 |
| FX30B-5P-3.81DSA30 | CL0570-3303-0-00 | 31.99 | 26.84 | 15.24 | 29.64 | 24.64 | 24.24 | 5 |

◆Tray Packaging State Diagram

●Right angle receptacle (S-DS type)

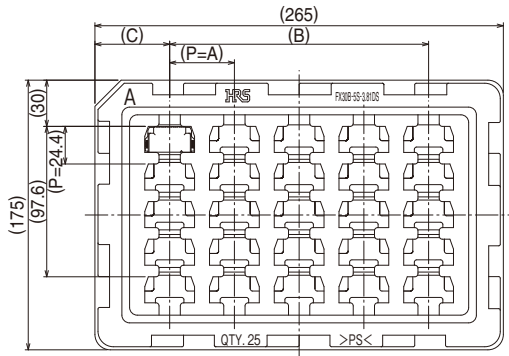

Unit: mm

| Product No. | A | B | C | Quantity |
|-----------------|------|-------|-------|----------|
| FX30B-2S-3.81DS | 30 | 180 | 42.5 | 35 |
| FX30B-3S-3.81DS | 35.5 | 177.5 | 43.75 | 30 |
| FX30B-4S-3.81DS | | | | |
| FX30B-5S-3.81DS | 42 | 168 | 48.5 | 25 |

●Straight receptacle (S-DSA type)

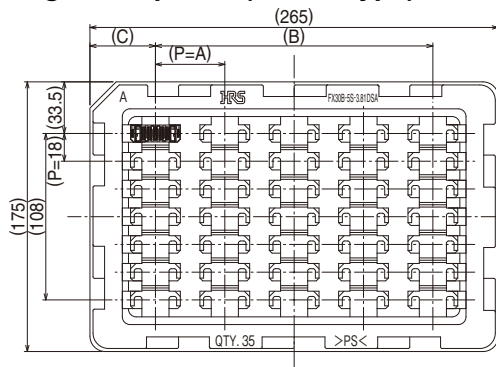

Unit: mm

| Product No. | A | B | C | Quantity |
|------------------|------|-----|------|----------|
| FX30B-2S-3.81DSA | 31.5 | 189 | 38 | 49 |
| FX30B-3S-3.81DSA | 38 | 190 | 37.5 | 42 |
| FX30B-4S-3.81DSA | | | | |
| FX30B-5S-3.81DSA | 45 | 180 | 42.5 | 35 |

●Right angle header (P-DS type)

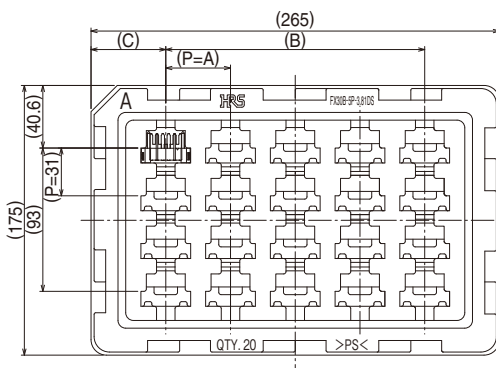

Unit: mm

| Product No. | A | B | C | Quantity |
|-----------------|------|-------|-------|----------|
| FX30B-2P-3.81DS | 30 | 180 | 42.5 | 28 |
| FX30B-3P-3.81DS | 35.5 | 177.5 | 43.75 | 24 |
| FX30B-4P-3.81DS | | | | |
| FX30B-5P-3.81DS | 42 | 168 | 48.5 | 20 |

●Straight header - ** (P-DSA** type)

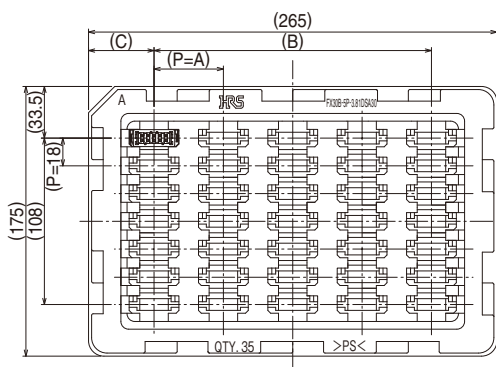

Unit: mm

| Product No. | A | B | C | Quantity |
|--------------------|------|-----|------|----------|
| FX30B-2P-3.81DSA** | 31.5 | 189 | 38 | 49 |
| FX30B-3P-3.81DSA** | 38 | 190 | 37.5 | 42 |
| FX30B-4P-3.81DSA** | | | | |
| FX30B-5P-3.81DSA** | 45 | 180 | 42.5 | 35 |

(Note) The above illustration shows a tray form example. Please refer to “delivery specifications” for official individual forms.

◆Cleaning conditions

●Organic Solvent Cleaning

| Solvent | Room temperature cleaning | Heated cleaning |
|-------------------------|---------------------------|-----------------|
| IPA (Isopropyl alcohol) | ○ | ○ |

●Water Cleaning

When using water cleaner (terpene, alkali saponifier, etc.), please select a cleaner according to the chart of effects to metal and resin issued by each cleaner manufacture. In addition, please make sure that the connectors are not left behind without removing moisture.

●Precautions for Cleaning

If flax or cleaner remains in the connector after it was cleaned using organic solvent or water cleaner, the performance of the connector may deteriorate. Make sure that the connectors are cleaned thoroughly.

◆Usage precautions

●A position misalignment absorption function is provided in this product. Please use this product within the dimensions shown in the below diagram, while taking into account the connector mounting position misalignments and PCB mating position misalignments.

●The purpose of the position misalignment absorption function provided on this product is to absorb the misalignments between the connector mounting positions and between the PCB mating positions. **This function cannot be used for the purpose to absorb mating position misalignments due to vibrations.** Please use the connectors after the PCBs have been fixed so that the connector positions are fixed securely. Avoid supporting PCBs by connectors only, and be sure to fix the PCBs using methods other than the connectors.

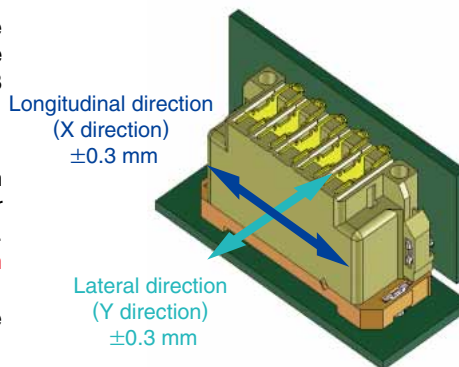

●This connector is designed to correct minor mating misalignments. This ability creates a structure that allows more for more movement and shifting between its pieces than with other similar connectors. The PCB boards need to be secured as well. If they are not, vibration or other external forces will cause the connectors to become unmated.

●This product has a structure to absorb position misalignments by the spring displacement of the contacts in pitch directions. Therefore, **a spring reaction force will be generated in the pitch directions when absorbing the position misalignments** (Approximately 4 N per 1 core) Please make sure that the structure bodies (positioning pins, screws, guiding rails, and other connectors, etc.) that will be used as the positioning base have enough strength against the spring reaction force.

●Allowable Mating Gap

The effective mating length of this product is 2 mm.

Use the connectors so that the gap between the header and receptacle when they are mated is within 1.0 or 1.3 mm. Particularly make sure the gap does not exceed the limits due to warping of PCB, etc.

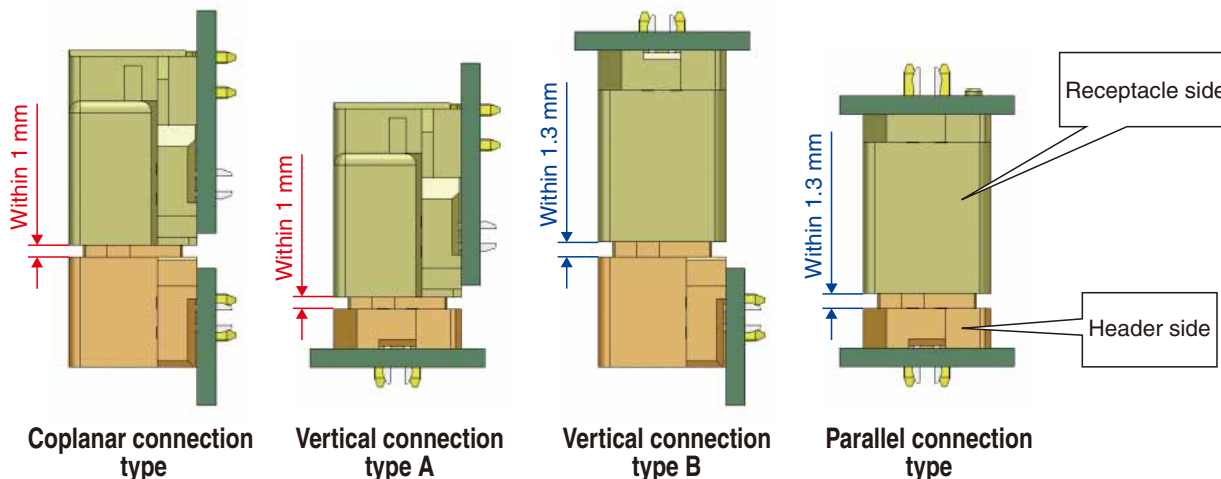

● A reverse insertion prevention structure and an abnormal mating position prevention structure have been provided in this connector, however, if the connectors are mated with an excessive force, connector breakage may result. Avoid improper mating of connectors by applying an excessive force and connect them correctly while confirming the connector polarities shown below. shown below. tors by applying an excessive force and connect them correctly while confirming the connector polarities shown below.

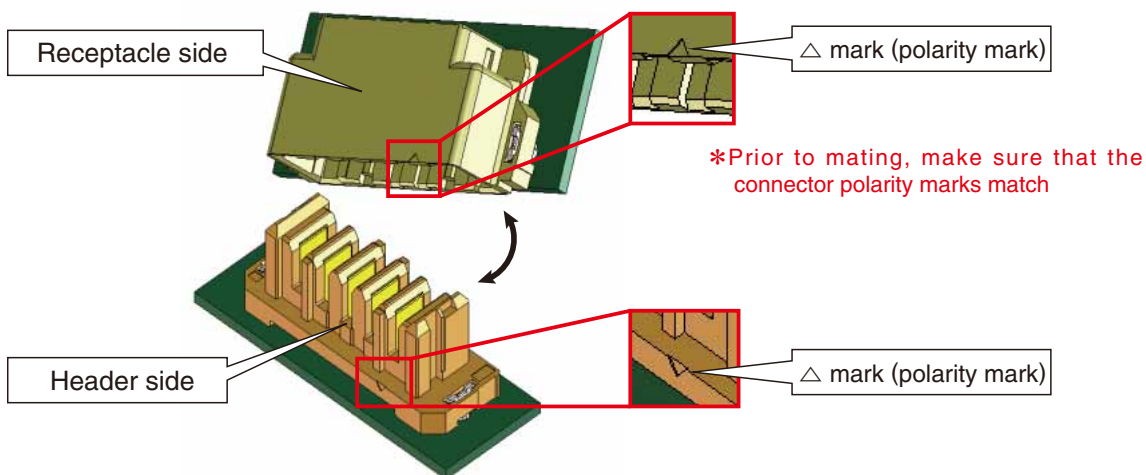

● A structure in which the contact deformation does not occur under normal mating operations has been provided on this connector, however, please make sure of the following; connector edge does not come to contact with the opening for mating, connectors are not mated diagonally in an abnormal manner, and foreign substances or hard objects, etc. do not touch the contacts. Pay attention so that contact deformation which causes a contact defect does not occur.

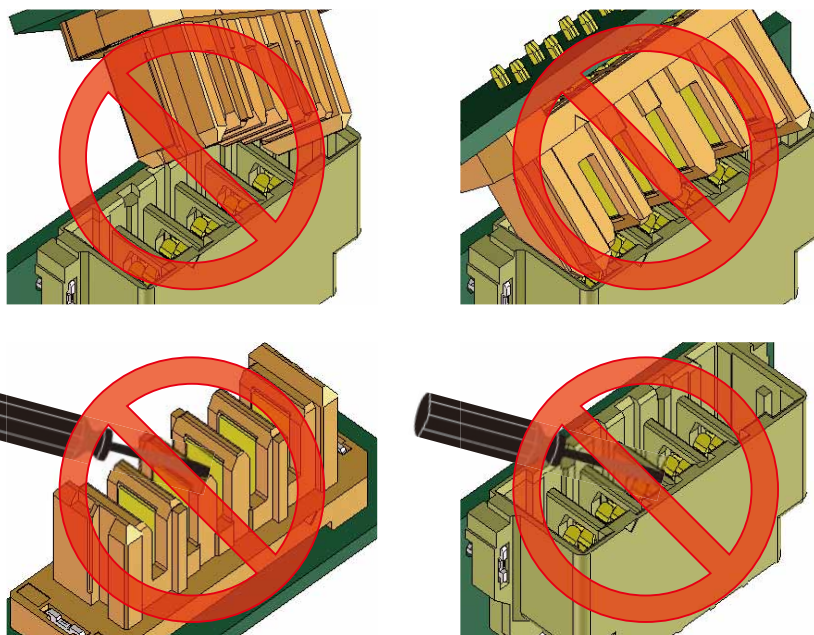

● If the connector is inserted/extracted forcibly in a wrong direction or it is rotated when inserting/extracting, a connector breakdown or contact defect may result. Please be careful.



● This product cannot be used for the purpose of current interruption application. (Prohibition of hot-swapping)

10 A Compatible, Position Misalignment Absorption Type Power Supply Connector for PCB Connections

FX30A Series

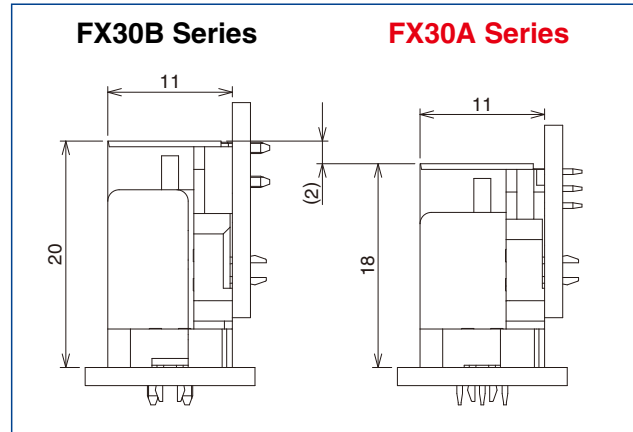

Features

The FX30A series is 2mm smaller type than FX30B series in mating axis direction. **The FX30A and FX30B series connectors are two independent series and are not compatible.** Do not try to mate them together as they do NOT have mating compatibilities.

1. **Contact pitch: 3.81 mm**
2. **Current capacity: 10 A/pin (Page 12.)**
*For details, see the derating curve.(Described on page 13.)
3. **Connection type: Vertical**
4. **Number of Pos.: 2 / 3 / 4 / 5 Pos.**
5. **Position Misalignment Absorption Movable Amount: ± 0.3 mm**
 - (1)Reliable to mounting misalignment when using multiple connectors.
 - (2)Other products without position misalignment absorption can be used together.
6. **Effective Mating Length: 2 mm**
The effective mating length is 2 mm long, so it has an enough margin for the mating stroke. (3.0 mm for longer contacts)

7. Multi-point Contact Structure

It has superior contact reliability by employing an independent four-point contact spring structure.

8. Low Insertion/Extraction Force

It offers low insertion/extraction force by employing a two-step contact timing sequence.

9. Robustness

Reinforcement metal fittings that securely fix the connector to the PCB are added on both sides of the connector, providing excellent deformation resistance for up, down, left and right directions.

10. Large Guide Form Leads Superior Mating Ability

A large induction form has been provided, allowing easy mating operations. (Induction amount: ± 1.3 mm, with position misalignment absorption amount: ± 1.6 mm)

Mating variations

Vertical connection type A

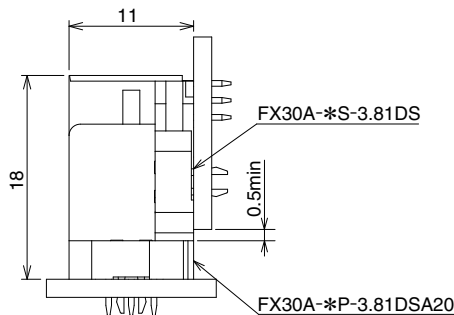

Note !

The FX30A and FX30B series connectors are two independent series and are not compatible. Do not try to cross mate them as they do NOT have mating compatibilities.

Functional Diagram

●Right angle receptacle

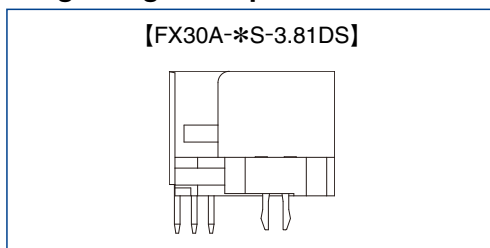

●Straight header

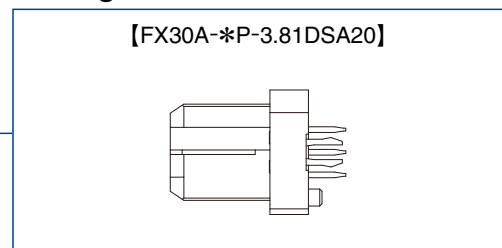

Vertical connection

Product Specifications

| | | |
|---------|---|--|
| Ratings | Current rating: 10 A (Note 3) (See the derating curve on page 13) Voltage rating: 250 V AC/DC | Operating temperature range: -55 to 105°C (Note 1) Operating humidity range : Relative humidity 85% max. (Not dewed) Storage temperature range : -10 to 60°C (Note 2) Storage humidity range : 40% to 70% |
|---------|---|--|

| Items | Specifications | Conditions |
|----------------------------------|--|---|
| 1. Contact resistance | 2 mΩ or less | Measured at 10 mA |
| 2. Insulation resistance | 1000 MΩ or more | Measured at 250 V DC |
| 3. Withstanding voltage | No flashover or breakdown | Conduct electricity by applying a voltage of 750 V AC for 1 minute |
| 4. Insertion/extraction lifespan | Contact resistance: 5 mΩ or less | Insert/extract 100 times |
| 5. Vibration resistance | No electric outage of 1μs or greater | Frequency: 10 to 55 Hz, half amplitude: 0.75 mm, 10 cycles in each of 3 axis directions for 5 minutes/cycle |
| 6. Shock resistance | No electric outage of 1μs or greater | Acceleration of 490 m/s ² , duration 11 ms, sine half-wave, 3 cycles in each of the 3 axes each in both directions |
| 7. Humidity resistance | Contact resistance: 5 mΩ or less Insulation resistance: 1000 MΩ or more | Temperature: 40°C, humidity: 90 to 95%, left for 96 hours |
| 8. Temperature cycle | Contact resistance: 5 mΩ or less Insulation resistance: 1000 MΩ or more | Temperature: -55 → 105°C Time: 30 → 30 min., 5 cycles |
| 9. Solder heat resistance | No melting of resin part, which affects the product performance | Solder tank: solder tank temperature: 260°C, 10 seconds Manual soldering: soldering iron temperature: 360°C, 5 seconds |

(Note 1) Includes temperature rise caused by current flow.

(Note 2) The term “storage” refers to the long-term storage condition of unused products before PCB mounting.

(Note 3) Current rating per 1 contact is used.

Materials

● Receptacle/Header Common

| Part | Material | Color/Treatment | Specification |
|-----------------------------|--------------------|---|---------------|
| Insulator | Polyamide resin | Black | UL94V-0 |
| Power supply contact | Copper alloy | Contact area: Gold plating Mounting area: Pure tin plating | —— |
| Reinforcement metal fitting | Phosphorous bronze | Whole body: Pure tin plating | —— |

Product Number Structure

Refer to this page when judging product specifications by model types. When making an order, please select a model type described in this catalog.

● Right angle receptacle

FX30A – **5** **S** – **3.81** **DS**

① ② ③ ④ ⑤

● Straight header

FX30A – **5** **P** – **3.81** **DSA** **20**

① ② ③ ④ ⑤ ⑥

| | |
|------------------------|--|
| ① Series name | FX30A |
| ② Number of Contacts | 2 to 5 |
| ③ Connector type | S: Receptacle type P: Header type |
| ④ Contact pitch | 3.81 mm |
| ⑤ Product type | DS: Right angle type DSA: Straight type |
| ⑥ Stacking height Type | |

Derating curve

(Electricity conducted through the 5 pins of 5-pin vertical connection type connector)

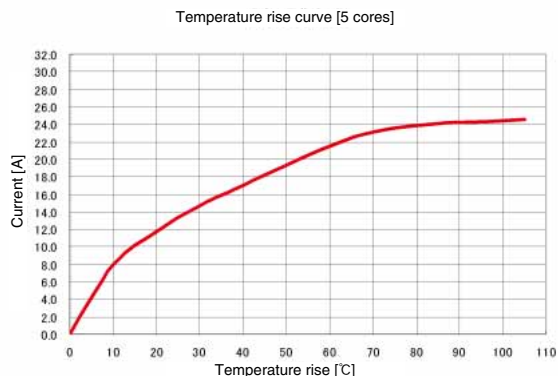
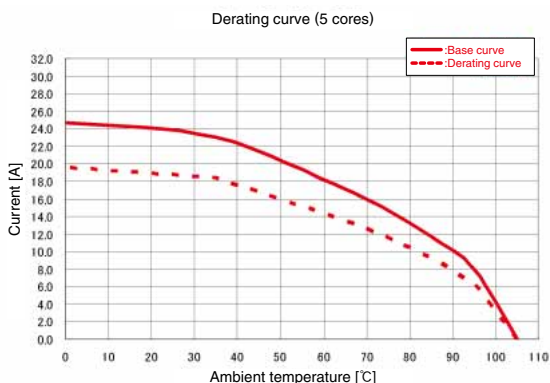

(Electricity conducted through the 4 pins of 4-pin vertical connection type connector)

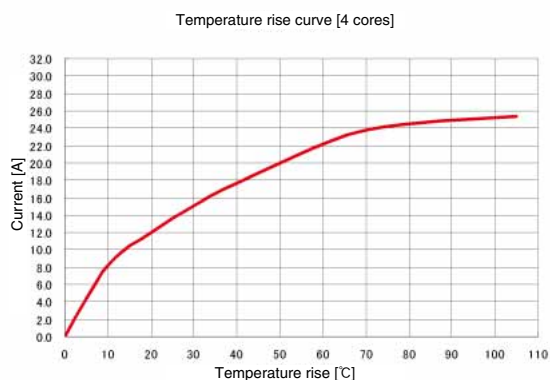
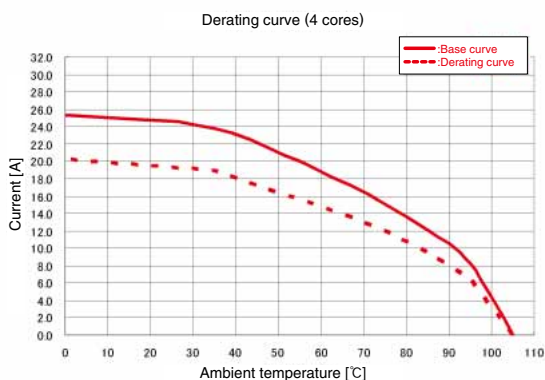

(Electricity conducted through the 3 pins of 3-pin vertical connection type connector)

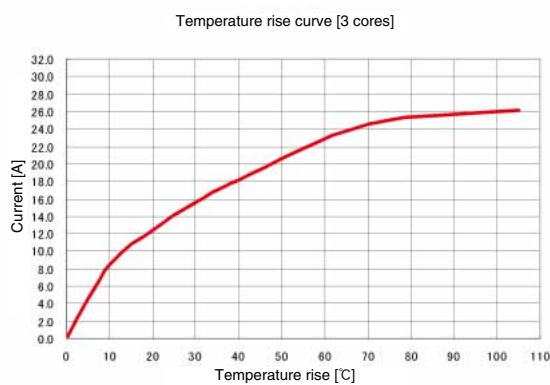
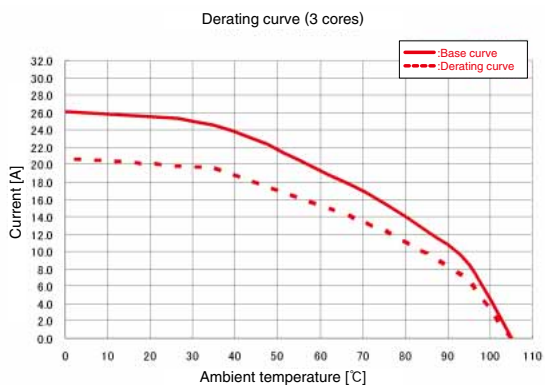

(Electricity conducted through the 2 pins of 2-pin vertical connection type connector)

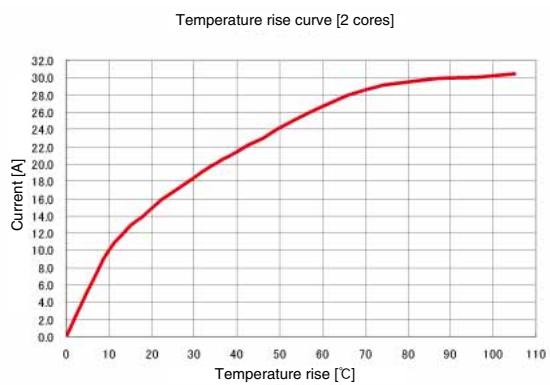
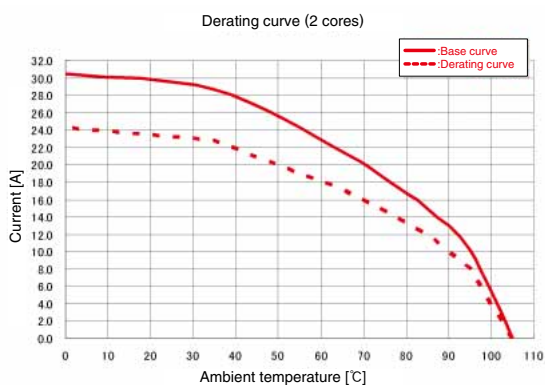

Note: The derating curve is created by multiplying a derating factor of 0.8 to the current value of the base curve.

● Right angle receptacle (S-DS type)

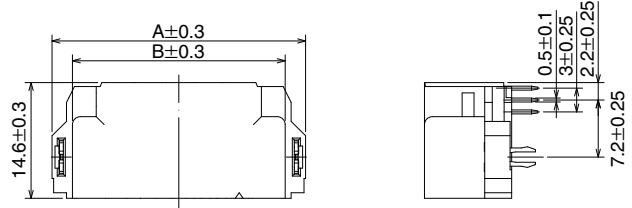

◆ Diagram of recommended PCB Layout dimensions

(Note) PCB thickness: $t = 1.6 \text{ mm}$

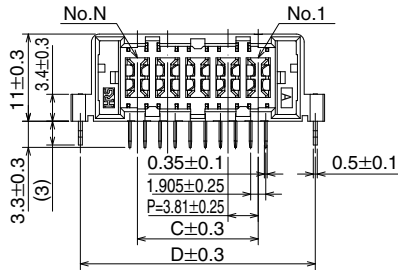
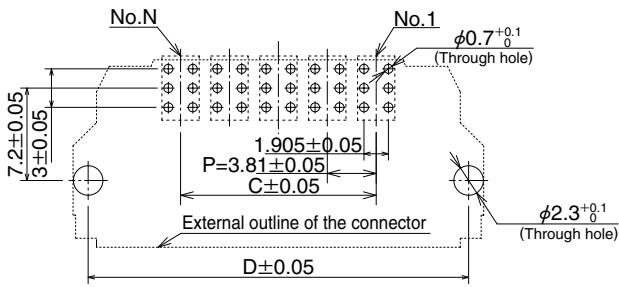

Unit: mm

| Product No. | HRS No. | A | B | C | D | N (No. of Contacts) |
|-----------------|------------------|-------|-------|-------|-------|---------------------|
| FX30A-2S-3.81DS | CL0570-2500-6-00 | 20.56 | 15.41 | 3.81 | 18.21 | 2 |
| FX30A-3S-3.81DS | CL0570-2501-9-00 | 24.37 | 19.22 | 7.62 | 22.02 | 3 |
| FX30A-4S-3.81DS | CL0570-2502-1-00 | 28.18 | 23.03 | 11.43 | 25.83 | 4 |
| FX30A-5S-3.81DS | CL0570-2503-4-00 | 31.99 | 26.84 | 15.24 | 29.64 | 5 |

● Straight header (P-DSA20 type)

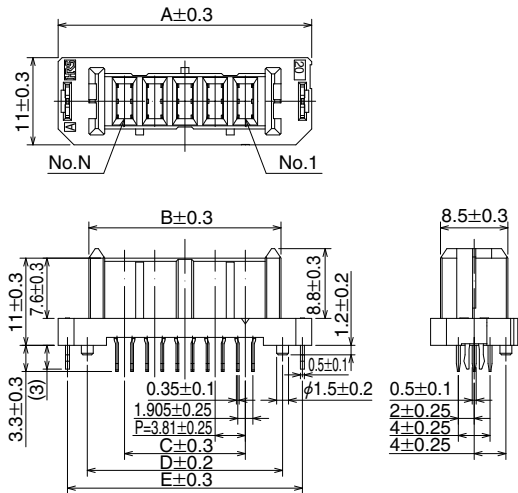

◆ Diagram of recommended PCB layout dimensions

(Note) PCB thickness: $t = 1.6 \text{ mm}$

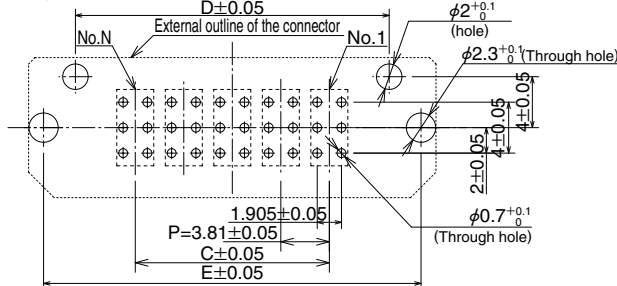

Unit: mm

| Product No. | HRS No. | A | B | C | D | E | N (No. of Contacts) |
|--------------------|------------------|-------|-------|-------|-------|-------|---------------------|
| FX30A-2P-3.81DSA20 | CL0570-2100-8-00 | 20.56 | 12.81 | 3.81 | 13.21 | 18.21 | 2 |
| FX30A-3P-3.81DSA20 | CL0570-2101-0-00 | 24.37 | 16.62 | 7.62 | 17.02 | 22.02 | 3 |
| FX30A-4P-3.81DSA20 | CL0570-2102-3-00 | 28.18 | 20.43 | 11.43 | 20.83 | 25.83 | 4 |
| FX30A-5P-3.81DSA20 | CL0570-2103-6-00 | 31.99 | 24.24 | 15.24 | 24.64 | 29.64 | 5 |

◆ Tray Packaging State Diagram

● Right angle receptacle (S-DS type)

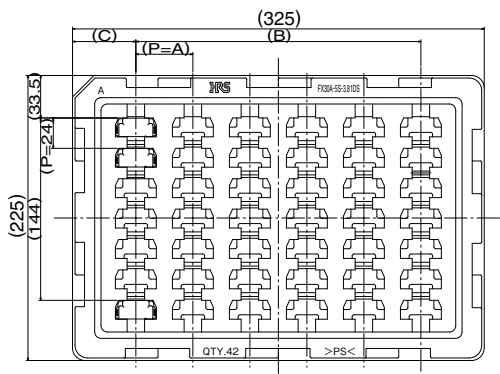

Unit: mm

| Product No. | A | B | C | Quantity |
|-----------------|------|-----|----|----------|
| FX30A-2S-3.81DS | 33 | 231 | 47 | 56 |
| FX30A-3S-3.81DS | 37.5 | 225 | 50 | 49 |
| FX30A-4S-3.81DS | 45 | 225 | 50 | 42 |
| FX30A-5S-3.81DS | | | | |

● Straight header (P-DSA20 type)

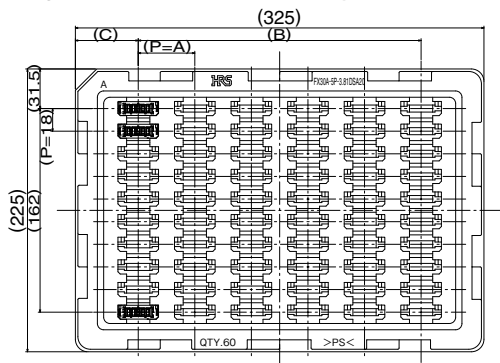

Unit: mm

| Product No. | A | B | C | Quantity |
|--------------------|------|-----|----|----------|
| FX30A-2P-3.81DSA20 | 33 | 231 | 47 | 80 |
| FX30A-3P-3.81DSA20 | 37.5 | 225 | 50 | 70 |
| FX30A-4P-3.81DSA20 | 45 | 225 | 50 | 60 |
| FX30A-5P-3.81DSA20 | | | | |

(Note) The tray shape depicted above is just an example. Please check “Delivery Specifications” for the official tray shapes.

◆ Cleaning conditions

● Organic solvent cleaning

| Solvent | Room temperature cleaning | Heated cleaning |
|-------------------------|---------------------------|-----------------|
| IPA (isopropyl alcohol) | ○ | ○ |

● Water Cleaning

When using water cleaner (terpene, alkali saponifier, etc.), please select a cleaner according to the chart of effects to metal and resin issued by each cleaner manufacture. In addition, please make sure that the connectors are not left behind without removing moisture.

● Precautions for Cleaning

If flux or cleaner remains in the connector after it was cleaned using organic solvent or water cleaner, the performance of the connector may deteriorate. Make sure that the connectors are cleaned thoroughly.

◆ Usage precautions

● A position misalignment absorption function is provided in this product. Please use this product within the dimensions shown in the below diagram, while taking into account the connector mounting position misalignments and PCB mating position misalignments.

● The purpose of the position misalignment absorption function provided on this product is to absorb the misalignments between the connector mounting positions and between the PCB mating positions.

This function cannot be used for the purpose to absorb mating position misalignments due to vibrations.

Please use the connectors after the PCBs have been fixed so that the connector positions are fixed securely.

Avoid supporting PCBs by connectors only, and be sure to fix the PCBs using methods other than the connectors.

● This connector is designed to correct minor mating misalignments. This ability creates a structure that allows more for more movement and shifting between its pieces than with other similar connectors. The PCB boards need to be secured as well. If they are not, vibration or other external forces will cause the connectors to become unmated.

● This product has a structure to absorb position misalignments by the spring displacement of the contacts in pitch directions. Therefore, **a spring reaction force will be generated in the pitch directions when absorbing the position misalignments** (Approximately 4 N per 1 core) Please make sure that the structure bodies (positioning pins, screws, guiding rails, and other connectors, etc.) that will be used as the positioning base have enough strength against the spring reaction force.

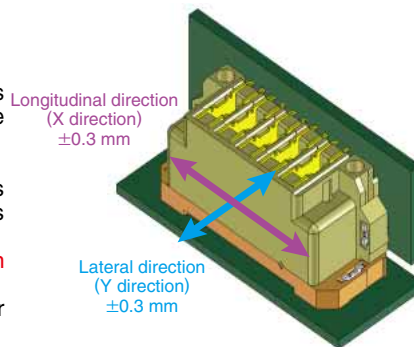

● **Allowable Mating Gap**

The effective mating length of this product is 2 mm. Use the connectors so that the gap between the header and receptacle when they are mated is within 1 mm. Particularly make sure the gap does not exceed 1 mm due to warping of PCB, etc.

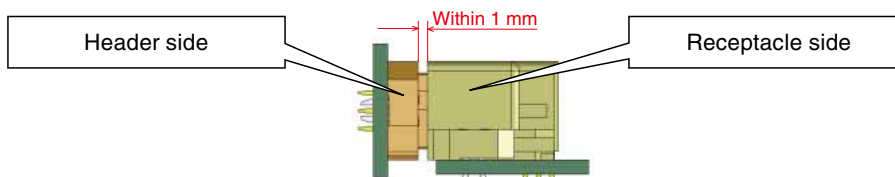

Vertical connection type

● A reverse insertion prevention structure and an abnormal mating position prevention structure have been provided in this connector, however, if the connectors are mated with an excessive force, connector breakage may result. Avoid improper mating of connectors by applying an excessive force and connect them correctly while confirming the connector polarities shown below. shown below. tors by applying an excessive force and connect them correctly while confirming the connector polarities shown below.

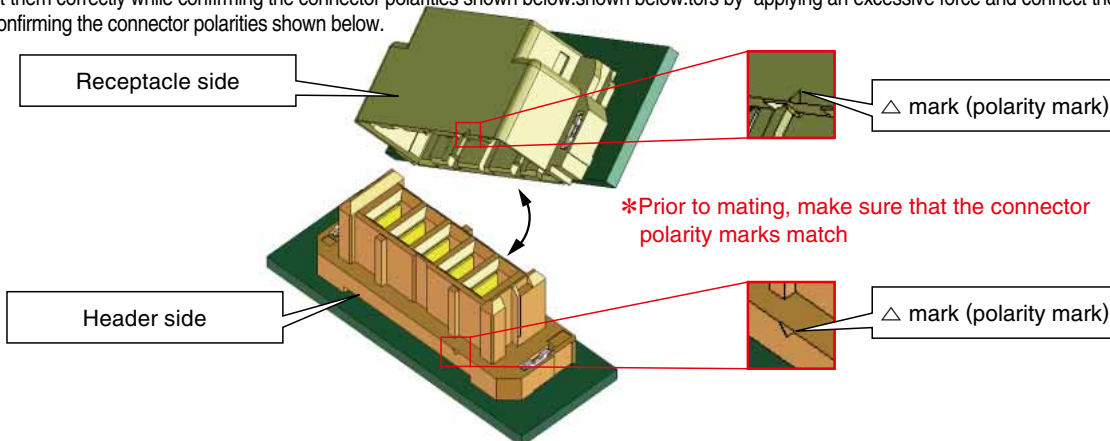

● A structure in which the contact deformation does not occur under normal mating operations has been provided on this connector, however, please make sure of the following; connector edge does not come to contact with the opening for mating, connectors are not mated diagonally in an abnormal manner, and foreign substances or hard objects, etc. do not touch the contacts. Pay attention so that contact deformation which causes a contact defect does not occur.

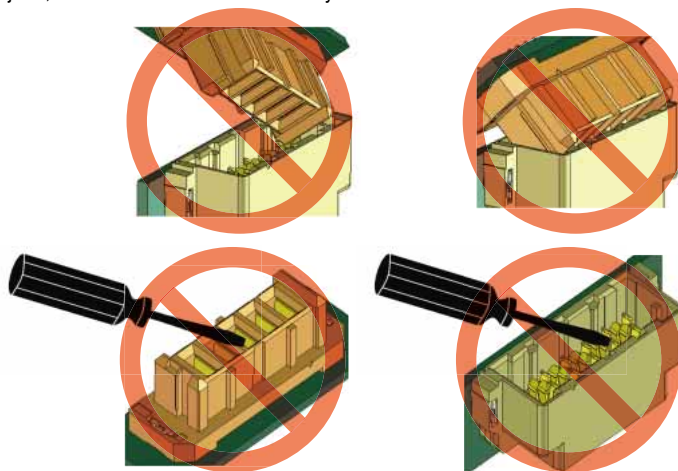

● If the connector is inserted/extracted forcibly in a wrong direction or it is rotated when inserting/extracting, a connector breakdown or contact defect may result. Please be careful.



● This product **cannot be used for the purpose of current interruption application.** (Prohibition of hot-swapping)



HIROSE ELECTRIC CO.,LTD.

6-3,Nakagawa Chuoh-2-Chome,Tsuzuki-Ku,Yokohama-Shi 224-8540,JAPAN
 TEL: +81-45-620-3526 Fax: +81-45-591-3726
<http://www.hirose.com>
<http://www.hirose-connectors.com>