

HDC1050EVM User 's Guide

User's Guide



Literature Number: SNAU181A
June 2015—Revised June 2015

HDC1050EVM User 's Guide

1 Introduction

The Texas Instruments HDC1050EVM evaluation module (EVM) enables designers to evaluate the operation and performance of the HDC1050 Relative Humidity and Temperature sensor.

The EVM contains one HDC1050 (See [Table 1](#)).

Table 1. Device and Package Configurations

DEVICE	IC	PACKAGE
U1	HDC1050	PWSON 6pin

The EVM hosts an MSP430F5528 microcontroller (μC) as well as the HDC1050. The μC is used to control the HDC1050 and communicate with a host PC through a USB port. The EVM is designed to be broken into two sections if desired. The sensor section can be separated from the μC section so that the user can remotely locate the sensor from the μC section.

2 Setup

This section describes the connectors on the EVM as well and how to properly connect, set up and use the HDC1050EVM.

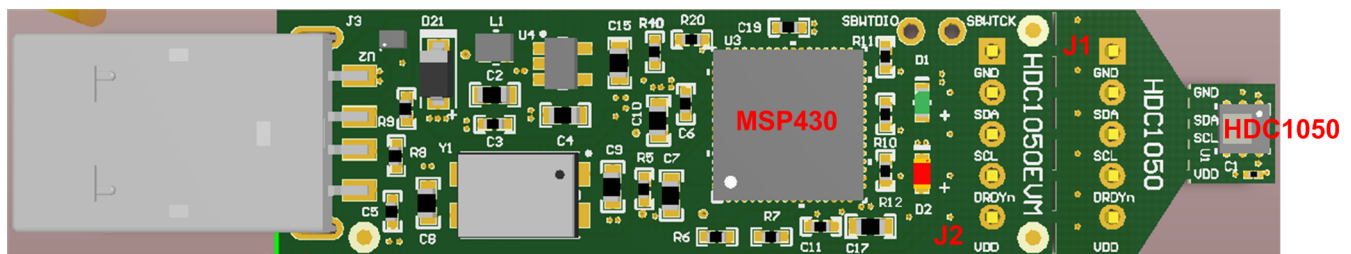

Figure 1. HDC1050EVM

2.1 Input/Output Connector Description

2.1.1 J1 – 5x1 Header

This header is not populated and can be installed if the EVM is broken in 2 sections: PC interface and Sensor. This connector with its counterpart J2 allows the communication of the two sections through a 4-wire cable.

Pin out:

- J1.1 GND
- J1.2 SDA
- J1.3 SCL
- J1.4 DRDY_n (**NOTE: this signal is not supported by the HDC1050, and does not need to be connected to a host controller**)
- J1.5 VDD

2.1.2 J2 – 5x1 Header

This header is not populated and can be installed if the EVM is broken in 2 sections: PC interface and Sensor. This connector with its counterpart J1 allows the communication of the two sections through a 5-wire cable.

Pin out:

- J2.1 GND
- J2.2 SDA
- J2.3 SCL
- J2.4 DRDY_n (**NOTE: this signal is not supported by the HDC1050n and does not need to be connected**)
- J2.5 VDD

2.1.3 J3 – USB Type A Connector

This connector is used for communications with the PC and provides power for the EVM.

2.2 Hardware Setup

The HDC1050EVM power is supplied via the USB connector. The LDO (U4) converts the 5V from the USB to 3.3V used by the HDC1050 and the MSP430. The EVM may be directly inserted into a USB port on a PC or laptop, or may be connected to the latter using the appropriate USB cable.

The I2C address of the HDC1050 is 1000000xb and is fixed by design.

The EVM features a Spy-by-Wire interface to the MSP430 that enables custom firmware development and debug using Code Composer Studio ©.

2.3 Software Setup

2.3.1 System Requirements

The Sensing Solutions GUI supports:

- 64-bit Windows 7
- 64-bit Windows XP

The current GUI does not support 32-bit Windows operating systems. The host machine is required for device configuration and data streaming. The following steps are necessary to prepare the EVM for the GUI:

- The GUI and EVM driver must be installed on the host.
- The EVM must be connected to a full speed USB port (USB 1.0 or above).

2.3.2 Sensing Solutions GUI and EVM Driver Installation

The Sensing Solutions GUI and EVM driver installer is packaged in a zip file. Follow these steps to install the software.

1. Download the software ZIP file from the EVM tool page
2. Extract the downloaded ZIP file
3. Run the included executable
4. Follow all directions from the installer

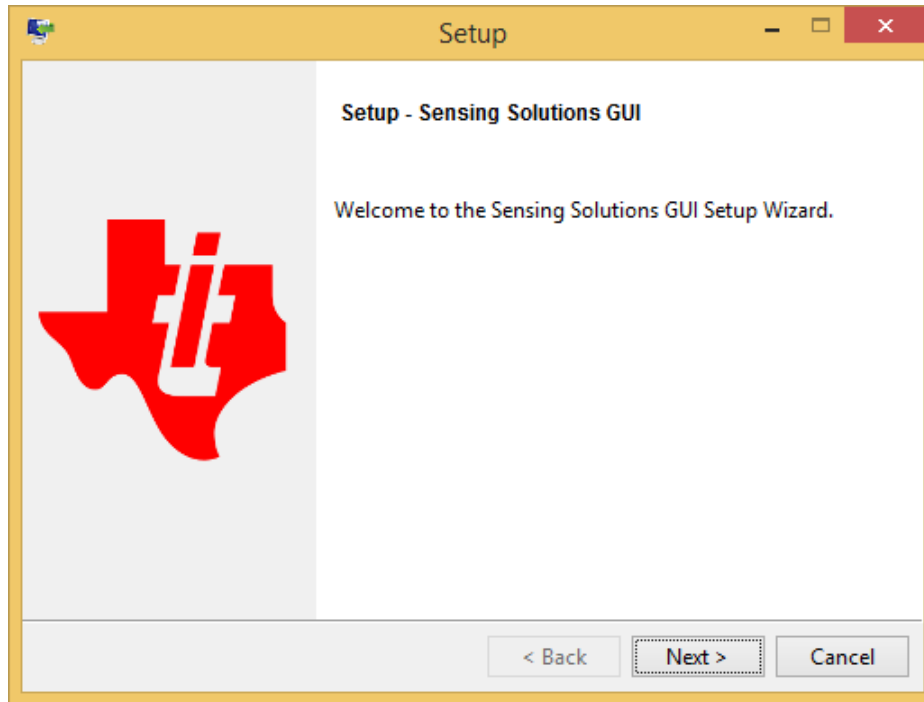

Figure 2. GUI Installer Welcome Page

5. Read the license agreement and if you still wish to install the software, select “I accept the agreement” and click “Next” as shown in

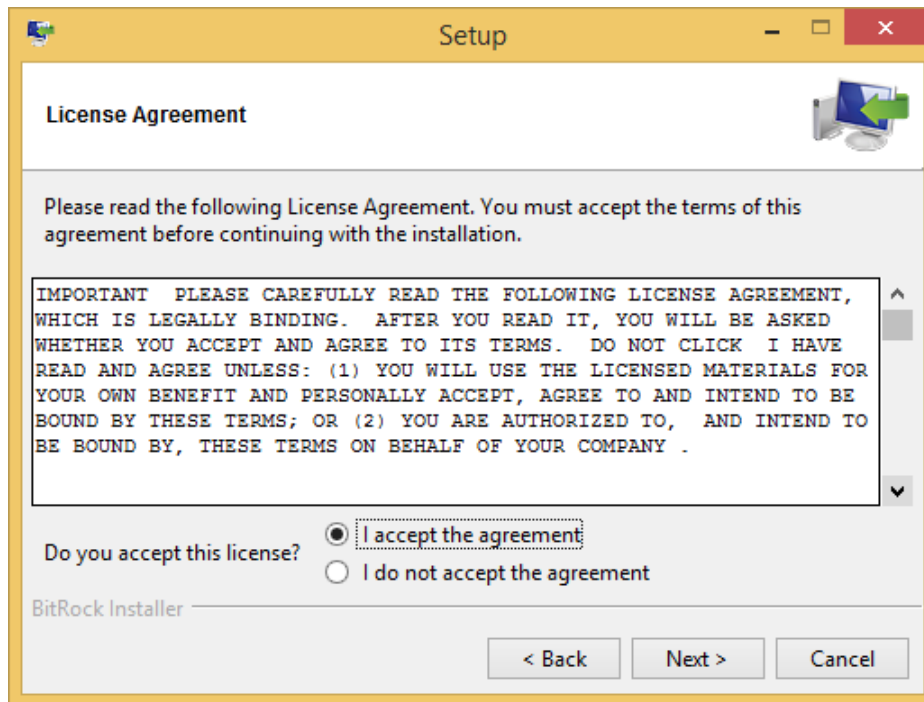

Figure 3. GUI Installer License Agreement

6. Select the installation directory. If the user installing the software is not a system administrator a directory not with “Program Files” should be chosen instead of the default.

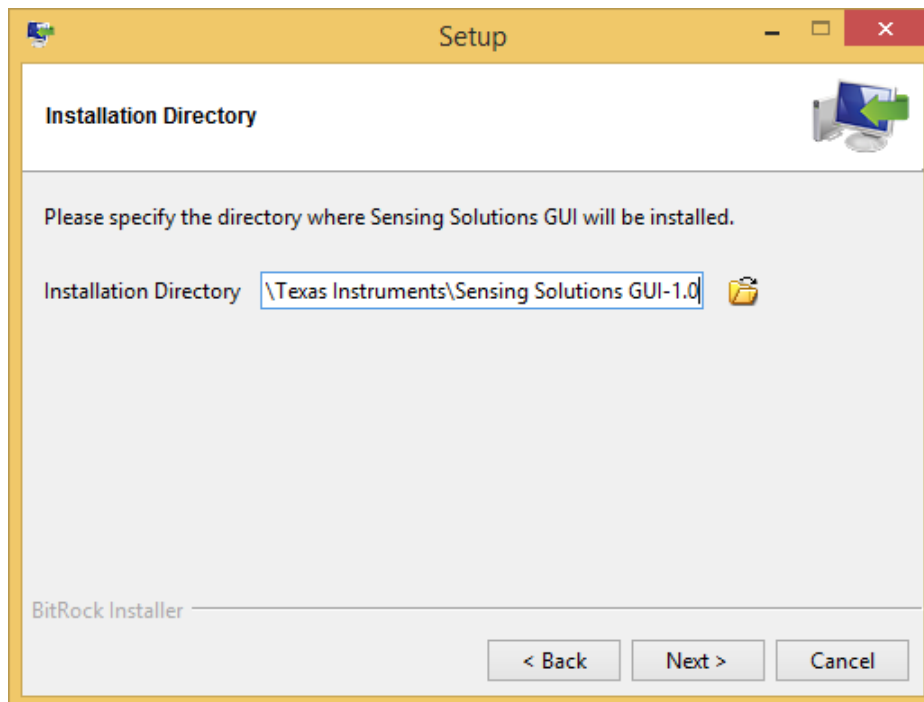

Figure 4. GUI Installer Installation Directory

7. Wait for all files to install

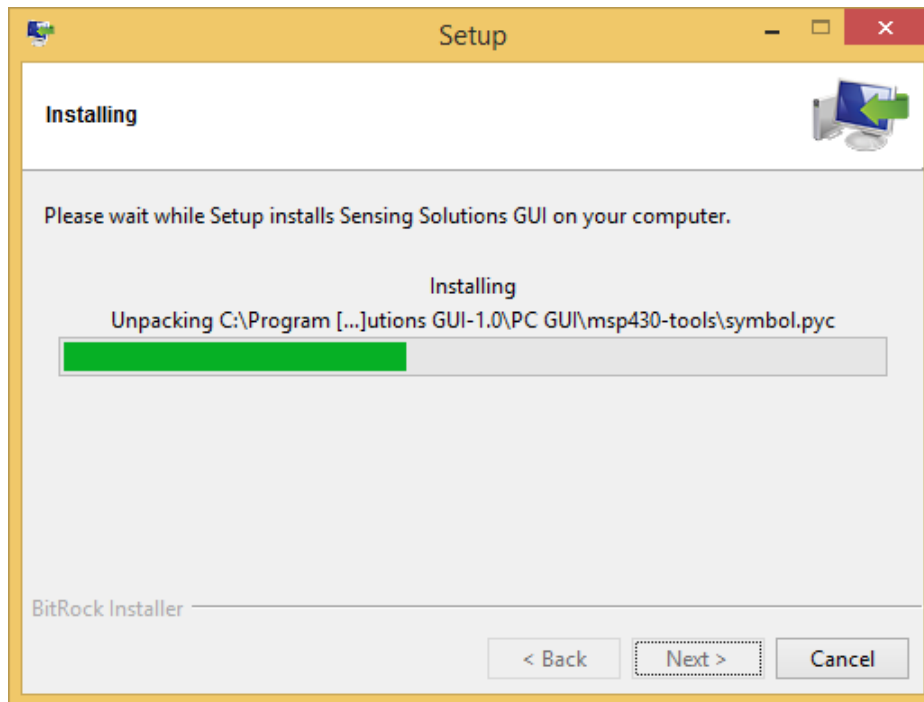

Figure 5. GUI Installer Copying Files

8. After the files have copied a device driver installer will start. If prompted about an unsigned driver, choose to install the driver anyways. If running Windows 8 or 8.1, the PC must be started in a “Safe” mode to install the unsigned driver.

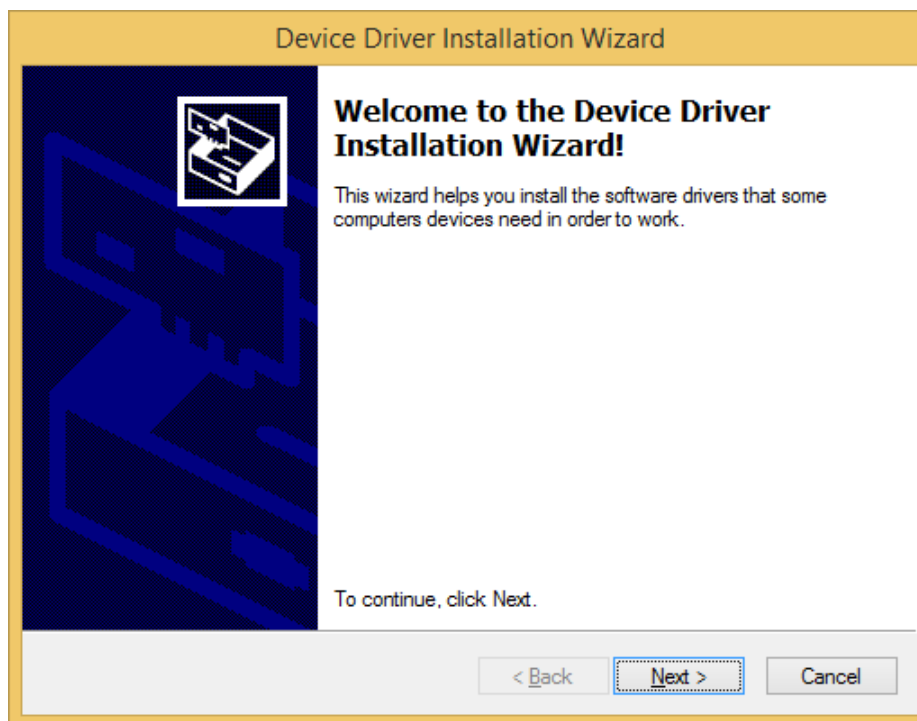

Figure 6. EVM Driver Installer Welcome Page

9. Wait for the driver to install

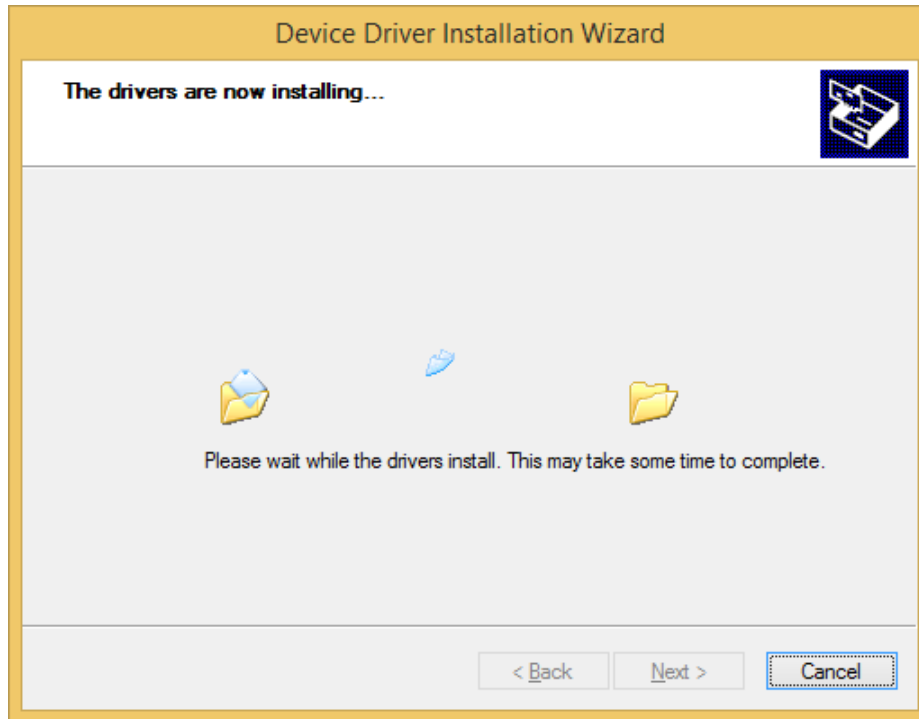

Figure 7. EVM Driver Installer In Progress

10. Click "Finish" after the driver has been installed

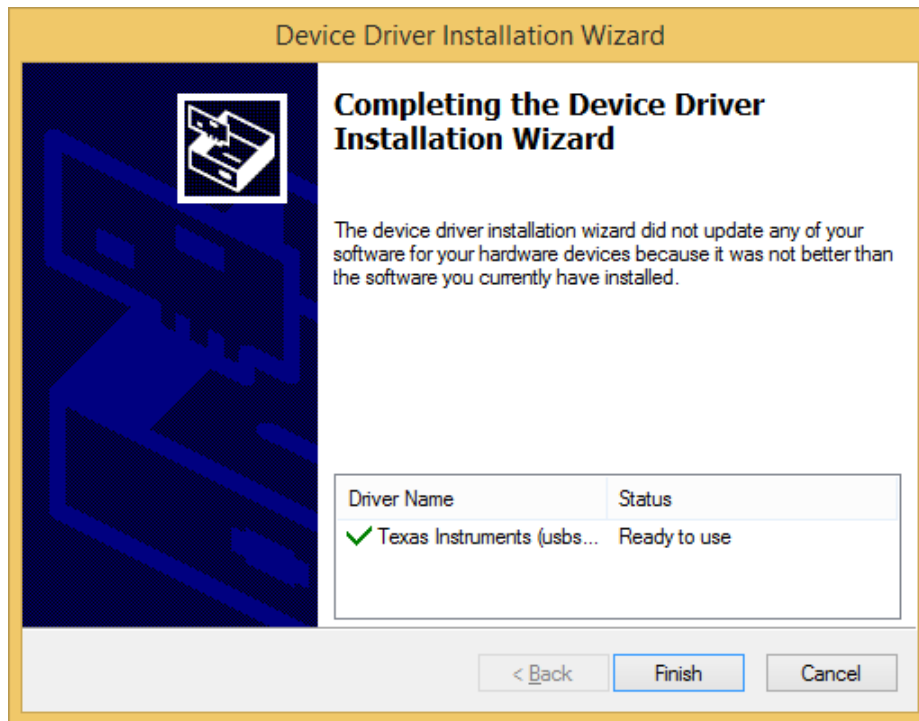

Figure 8. EVM Driver Installer Complete

11. Click "Finish" to complete the software installation

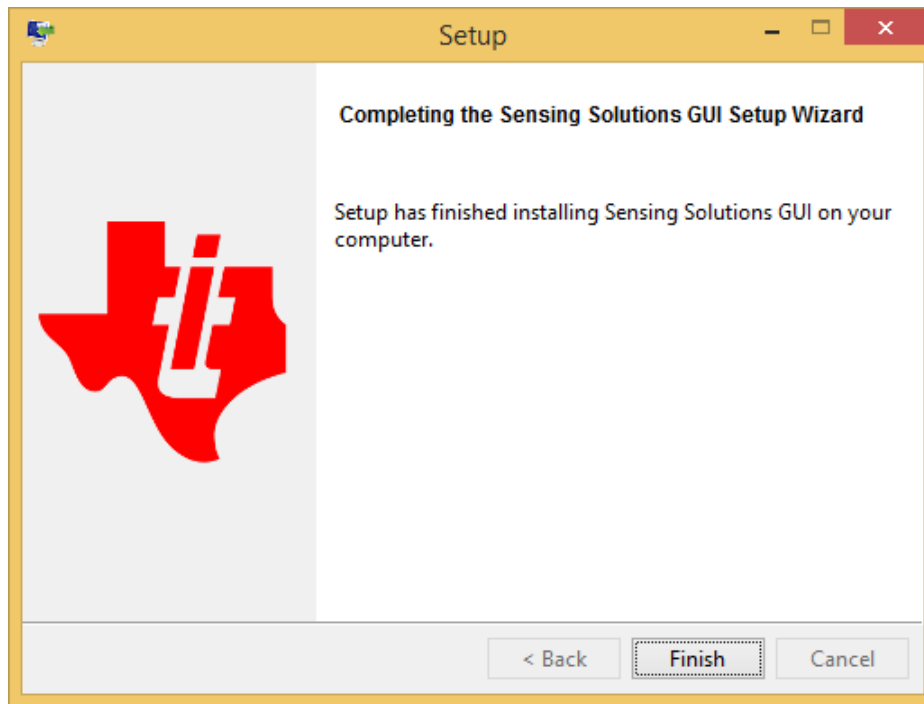

Figure 9. GUI Installer Complete

2.4 Operation

When the EVM is connected the host computer, the latter should automatically detect the device as an HDC1050EVM/HDC1000EVM.

Launch the GUI. A detailed description of the GUI operation is presented later in this document.

2.5 Reducing the Sensor Thermal Mass

The HDC1050EVM can be broken into 2 sections to isolate the thermal mass of the μC from the HDC1050. The yellow arrow in [Figure 10](#) shows the board perforations that allow the two sections to be broken apart.

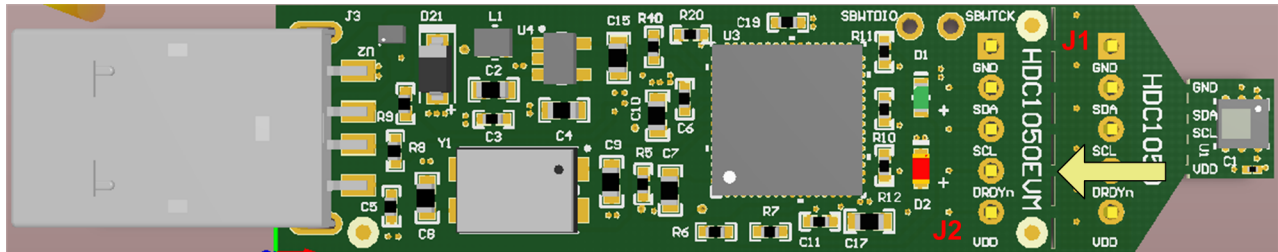

Figure 10. HDC1050EVM μC and Sensor Sections

The communication between the two modules is achieved through the connectors J1 and J2 and a 4-wire cable. In this configuration the thermal mass of the EVM is dramatically reduced, improving the temperature measurement performance of the HDC1050. The cable connecting J1 to J2 must conform to I2C cable length constraints. When used in this configuration, the GUI can still be used to communicate with the EVM and collect data.

If the thermal mass of the sensor section is still excessive, the sensor section can be reduced by breaking it at the perforation shown by the yellow arrow, indicated in [Figure 11](#). The PCB segment that hosts the HDC1050 is 5.5mm x 5mm.

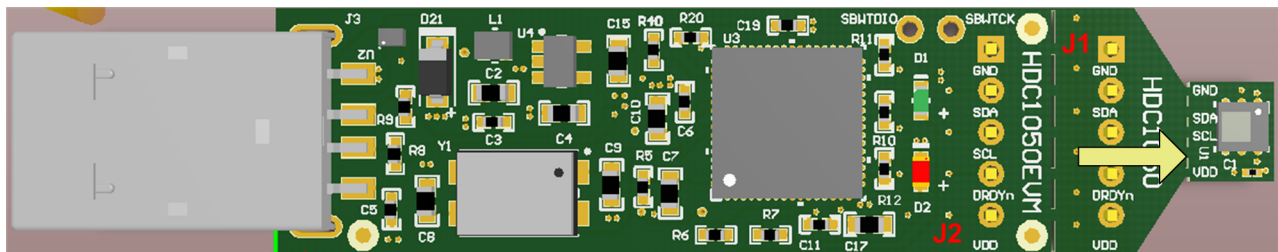

Figure 11. HDC1050EVM Small Sensor Section

The communications with the μC section is achieved through a 4-wire cable soldered at the pads accessible on the bottom layer of the PCB (Refer to [Figure 12](#)).

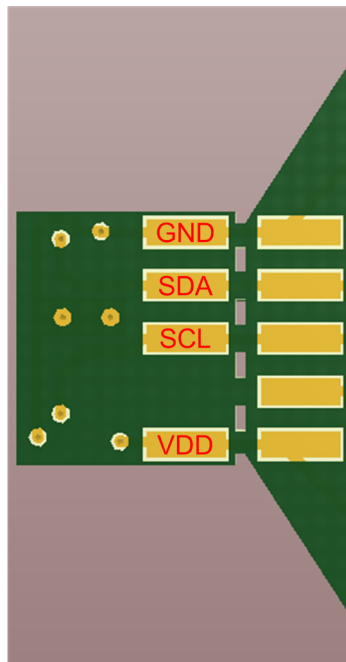

Figure 12. HDC1050EVM Pads for I2C and Supply of the Smaller Sensor Section

3 GUI Operation

The section describes how to use the GUI

3.1 Starting the GUI

Follow these steps to start the GUI:

1. Select the windows start menu
2. Select "All programs"
3. Select the "Texas Instruments" folder
4. Select the Sensing Solutions GUI
5. Click "Sensing Solutions GUI"
6. Splash screen will appear for at least two seconds.
 - Slower PC's may show a blank splash screen without any texts for up to 20 seconds

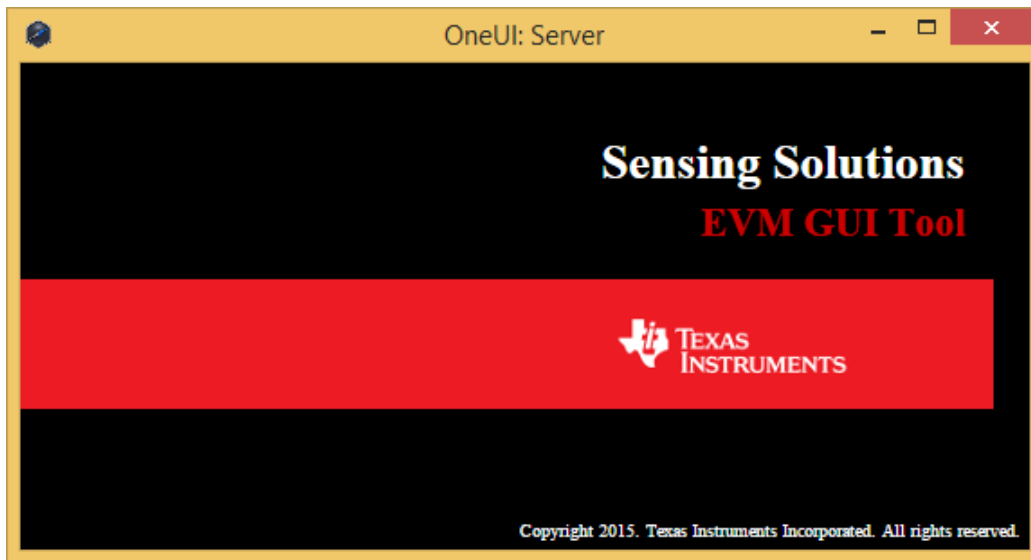

Figure 13. GUI Splash Screen

7. After the splash screen is displayed the main window will open. Note: Only one instance of the GUI may be open at a time!

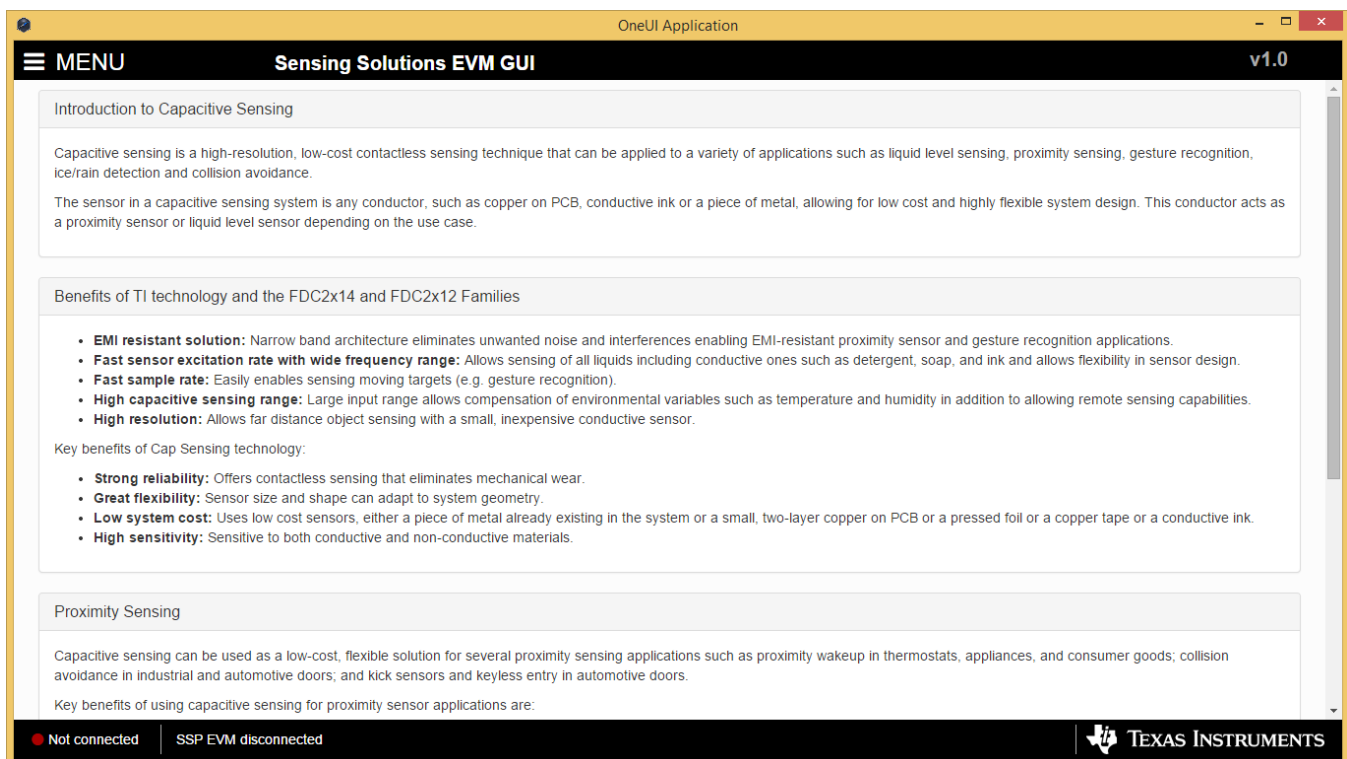

Figure 14. GUI Introduction Page

3.2 Connecting the EVM

Follow these steps to connect the EVM to the GUI:

1. Attach the EVM to the computer via the USB port.
2. The GUI always shows the connection status on the bottom left corner of the GUI

- The initial release of this GUI does not support multiple GUI instances or multiple devices. To control multiple EVMs, virtual machines may be used or multiple PC's are required. Future releases will support multiple EVMs from a single instance of the GUI.

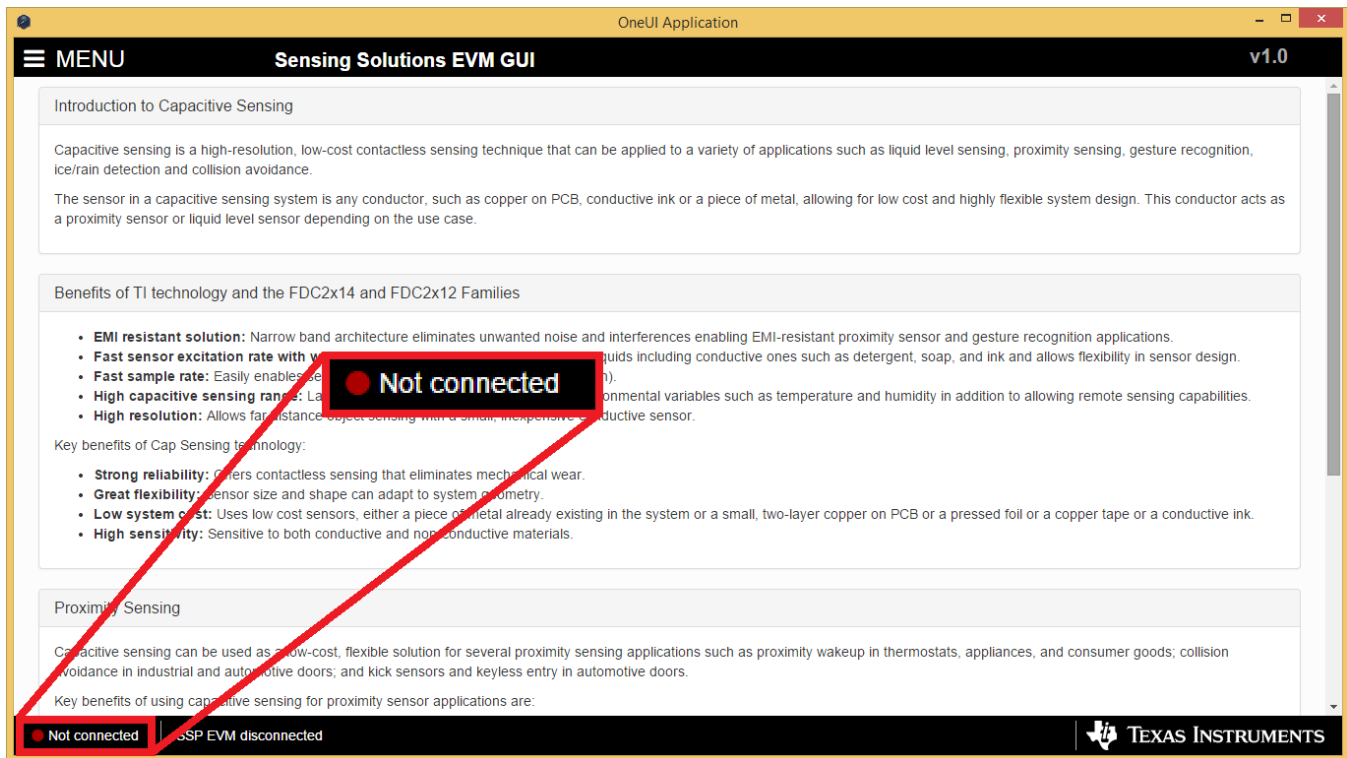

Figure 15. GUI Disconnected From EVM

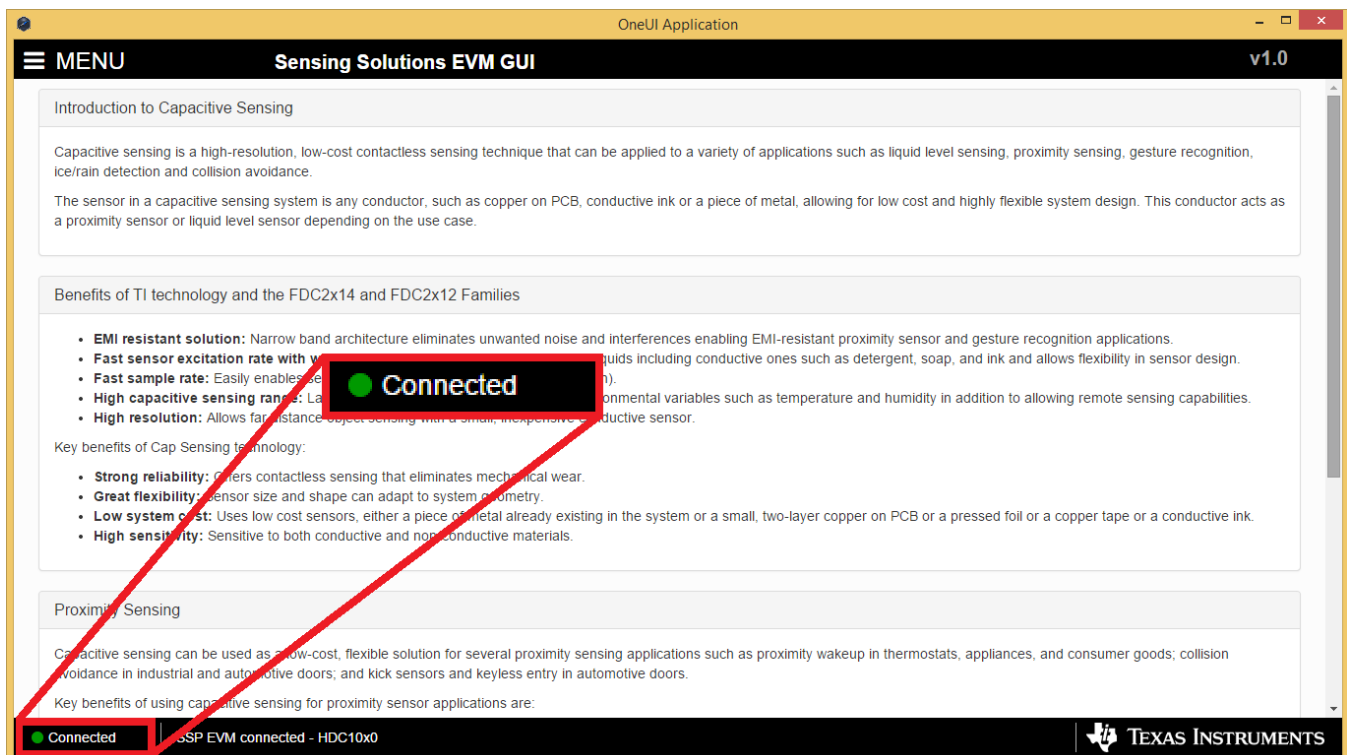

Figure 16. GUI Connected from EVM

3.3 Navigating the GUI

To navigate to different pages of the GUI follow these steps:

1. Click “Menu” in the upper left corner

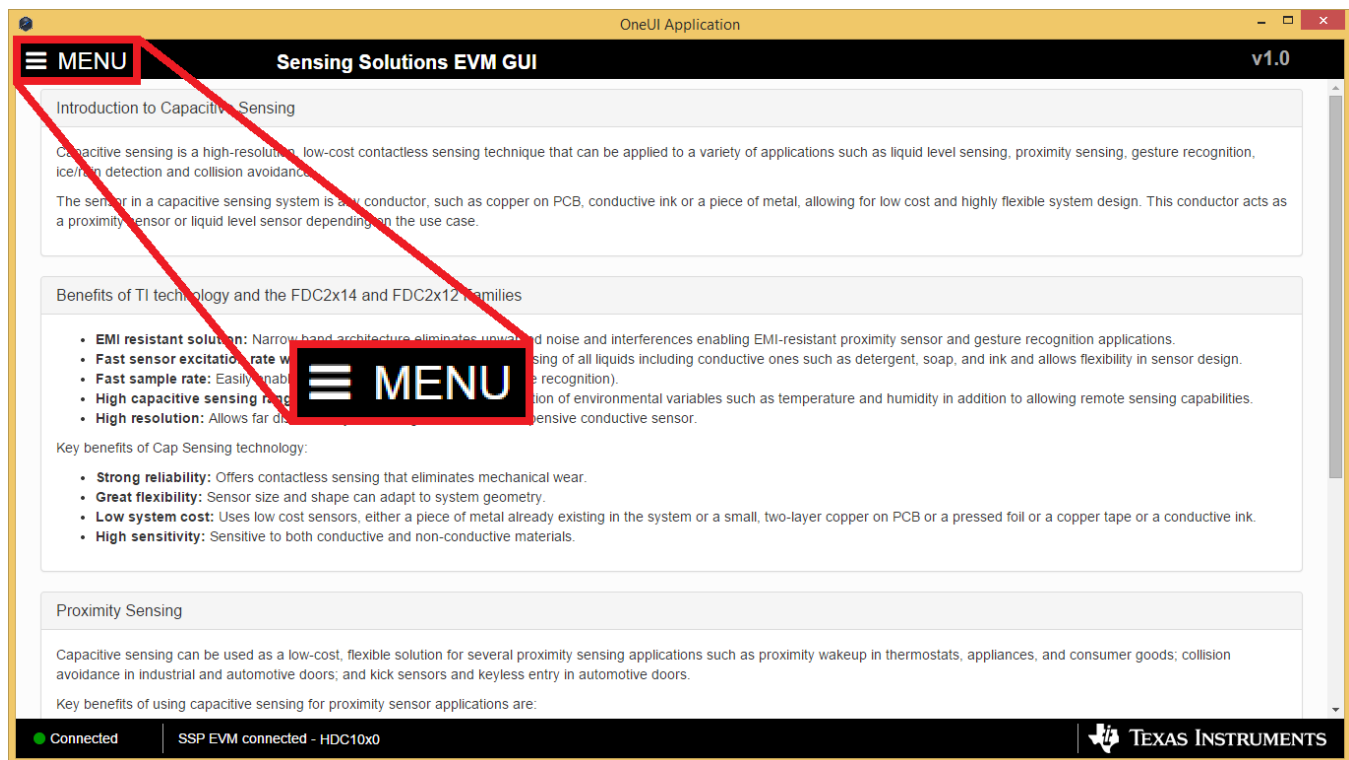

Figure 17. GUI Menu Button

2. Select the desired page from the menu shown on the left

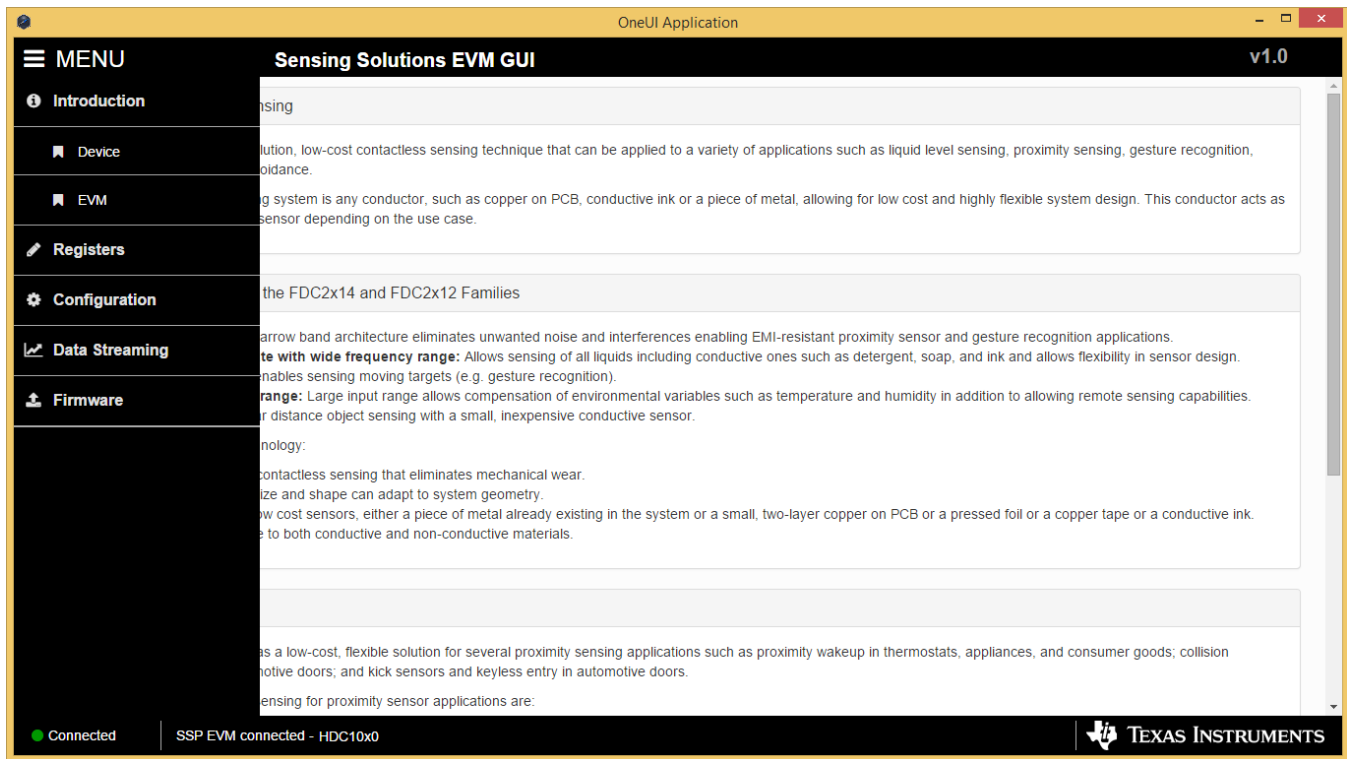

Figure 18. GUI Navigation Menu

3.4 Configuring the Device using Register Page

The register page allows users to control the device directly with the register values. The user may also use this page to read the current register values on the device.

3.4.1 Automatically Updating GUI Register Values Using Auto-Read

Autoread will periodically request the register values on the device. Click the dropdown box next to "Auto Read" to select the update interval.

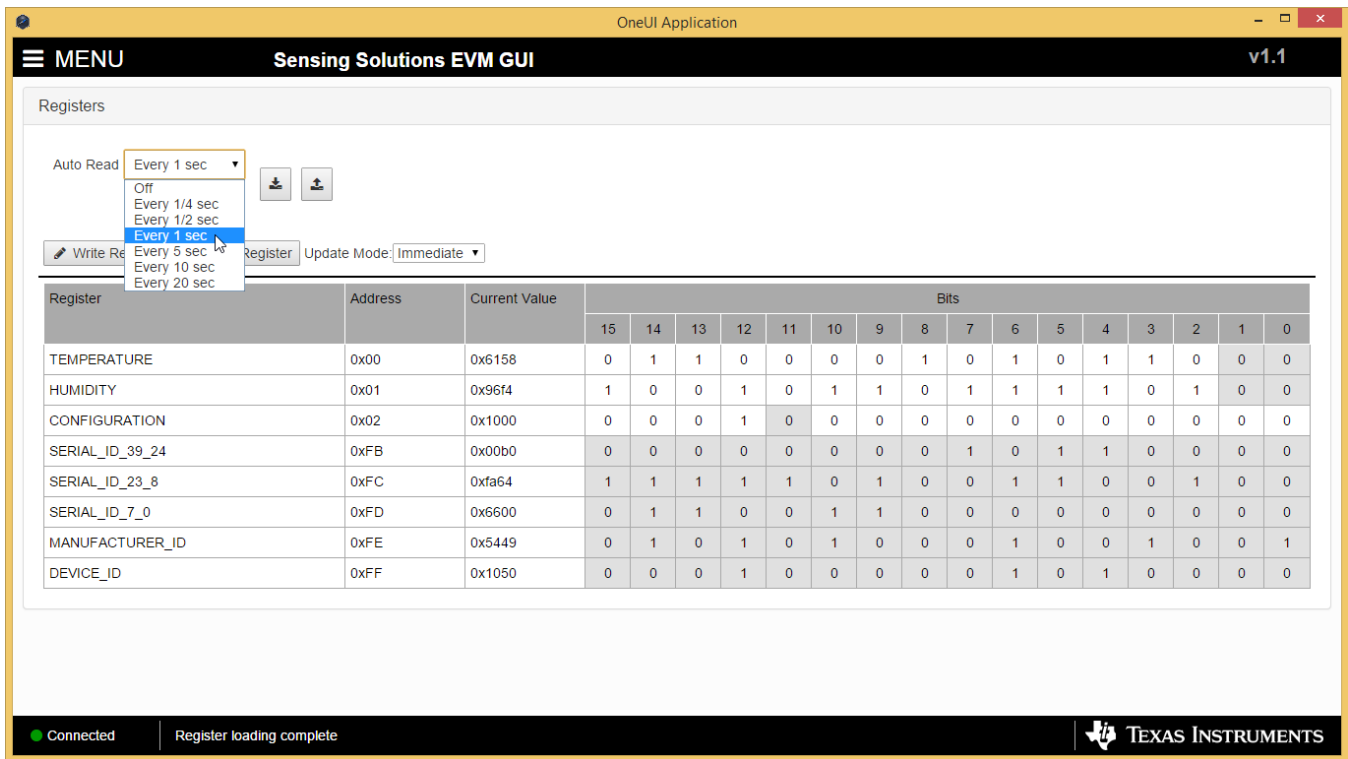

Figure 19. Selecting Auto-Read Interval on Register Page

3.4.2 Manually Updating Device Register Values

There are two methods to change register values: update the entire register value or change a single bit within the register. The recommended update mode is always “Immediate” and not “Deferred”. To update register values, follow these steps.

1. Double-click the current value of the register that needs to be changed. The text will turn into an editable text box

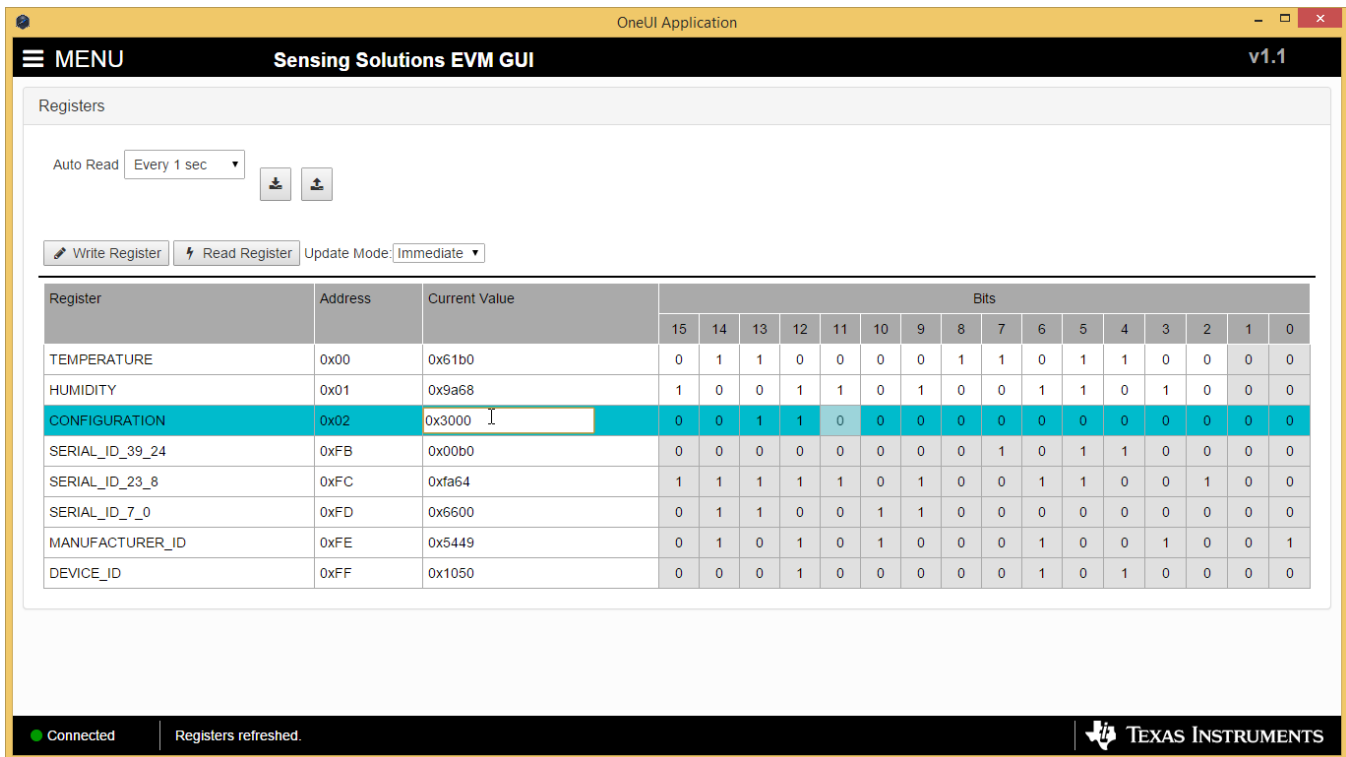

Figure 20. Selecting a Register's Current Value for Editing on Register Page

2. Type the new value in hexadecimal into the box and click enter. The text box changes to normal text and the GUI will send a command to the EVM to update the device register

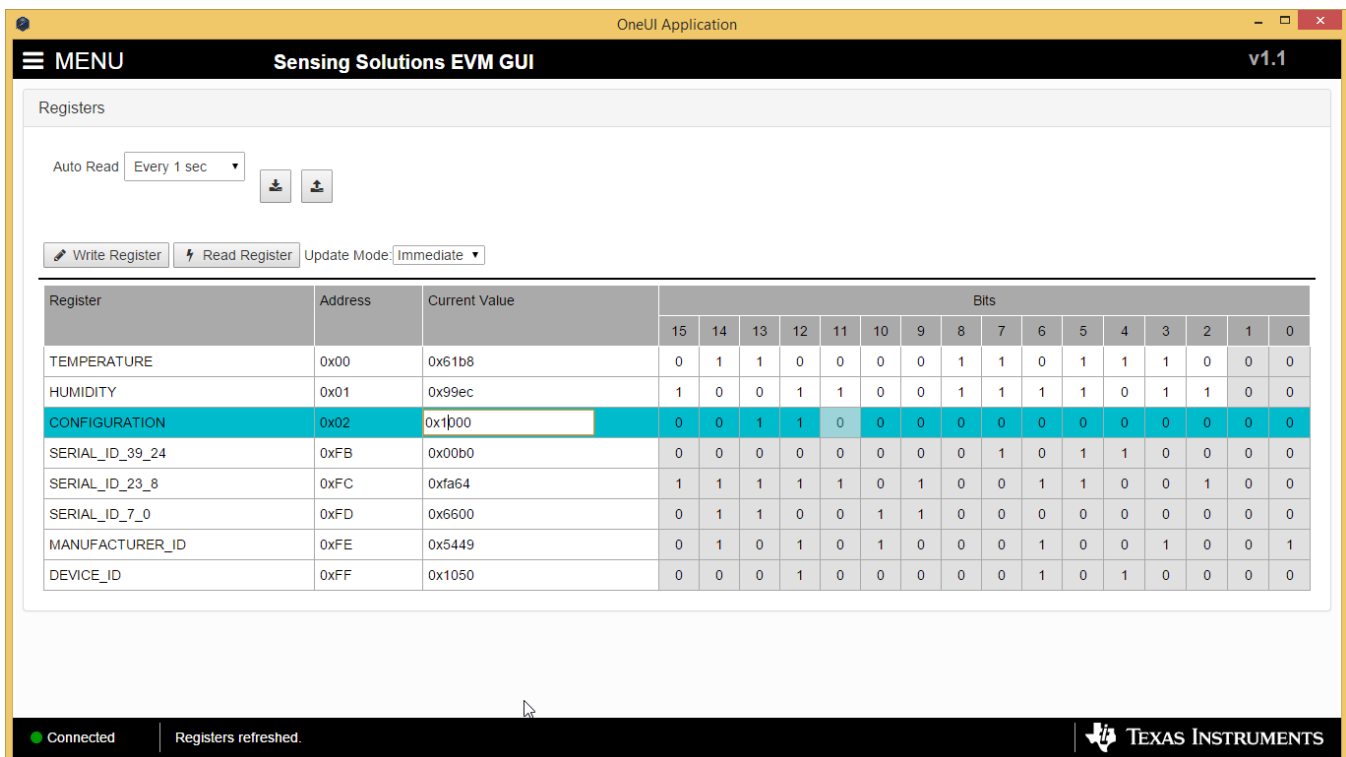

Figure 21. Entering New Value for Register on Register Page

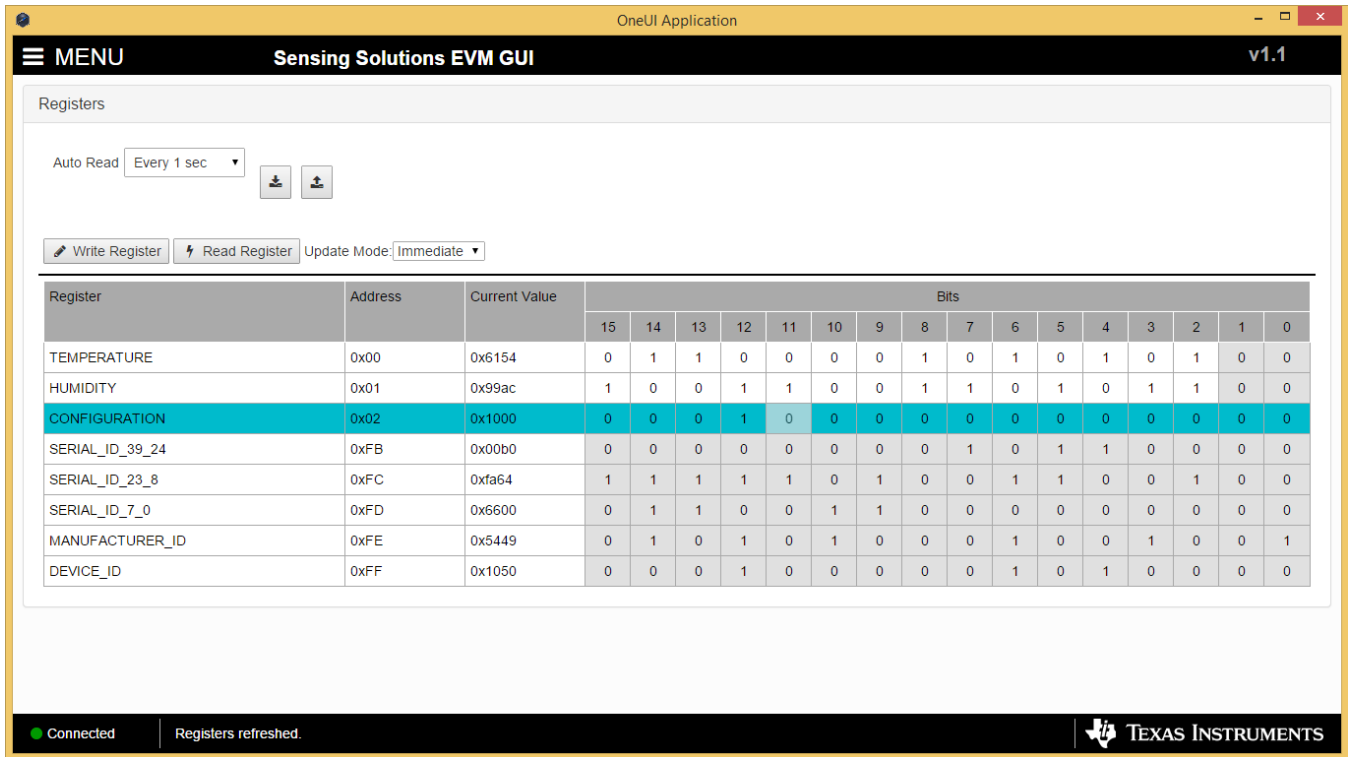

Figure 22. Register Value Updated After Changing Value on Register Page

To change individual bit values rather than entire register values follow these steps.

1. Hover the mouse over the desired bit to change

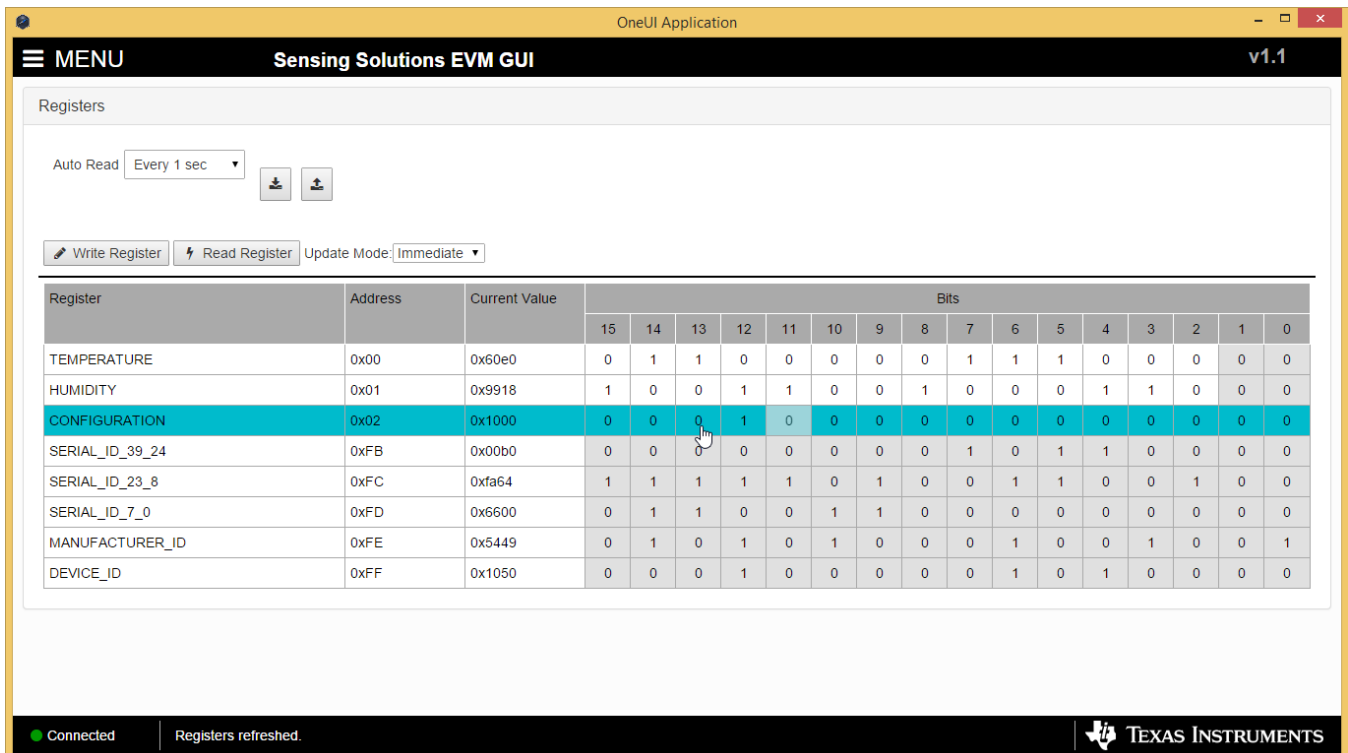

Figure 23. Hovering Mouse Over Register Bit Value on Register Page

2. Double-click the bit to toggle its value and the register's current value will update automatically

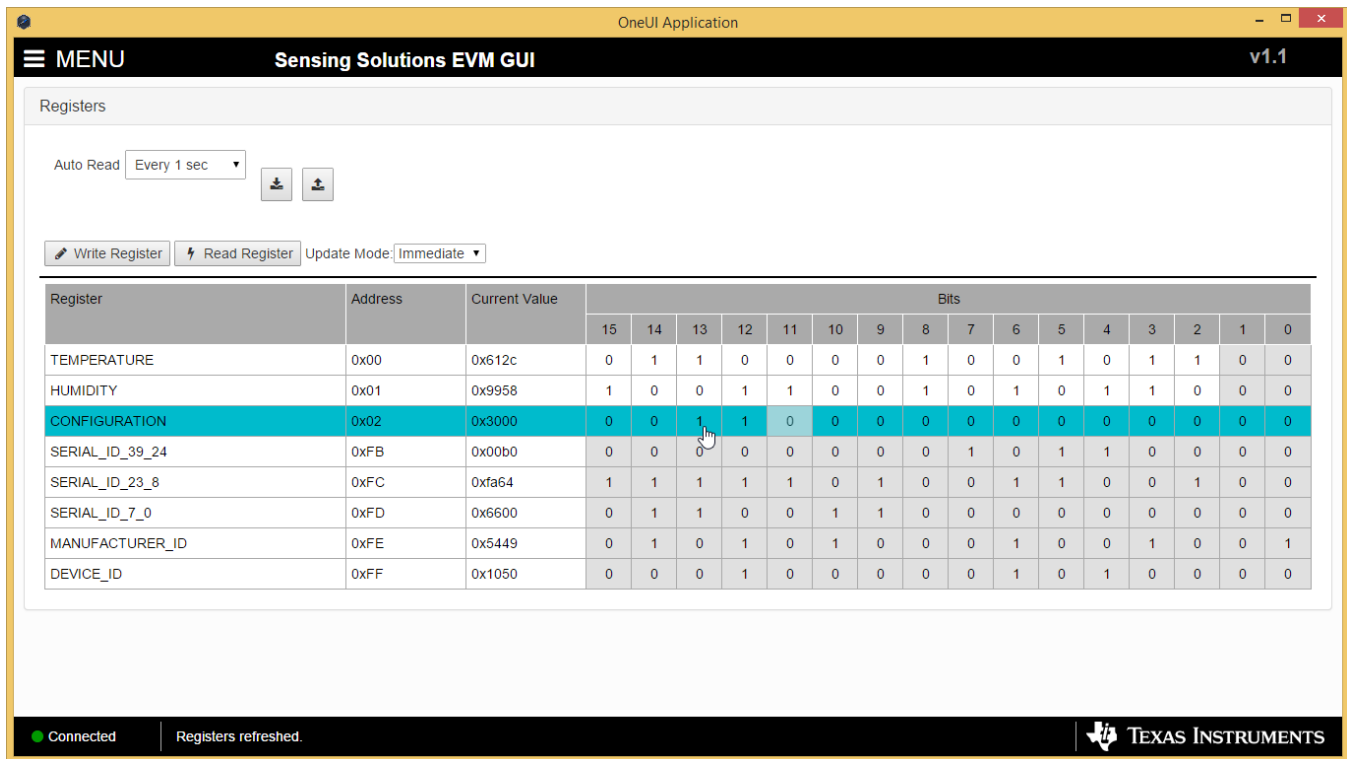

Figure 24. Toggling Register Bit Value on Register Page

3.4.3 Reading Register Values without Auto-Read

To read register values follow these steps.

1. Select the register to update by clicking any column of the register row in the table

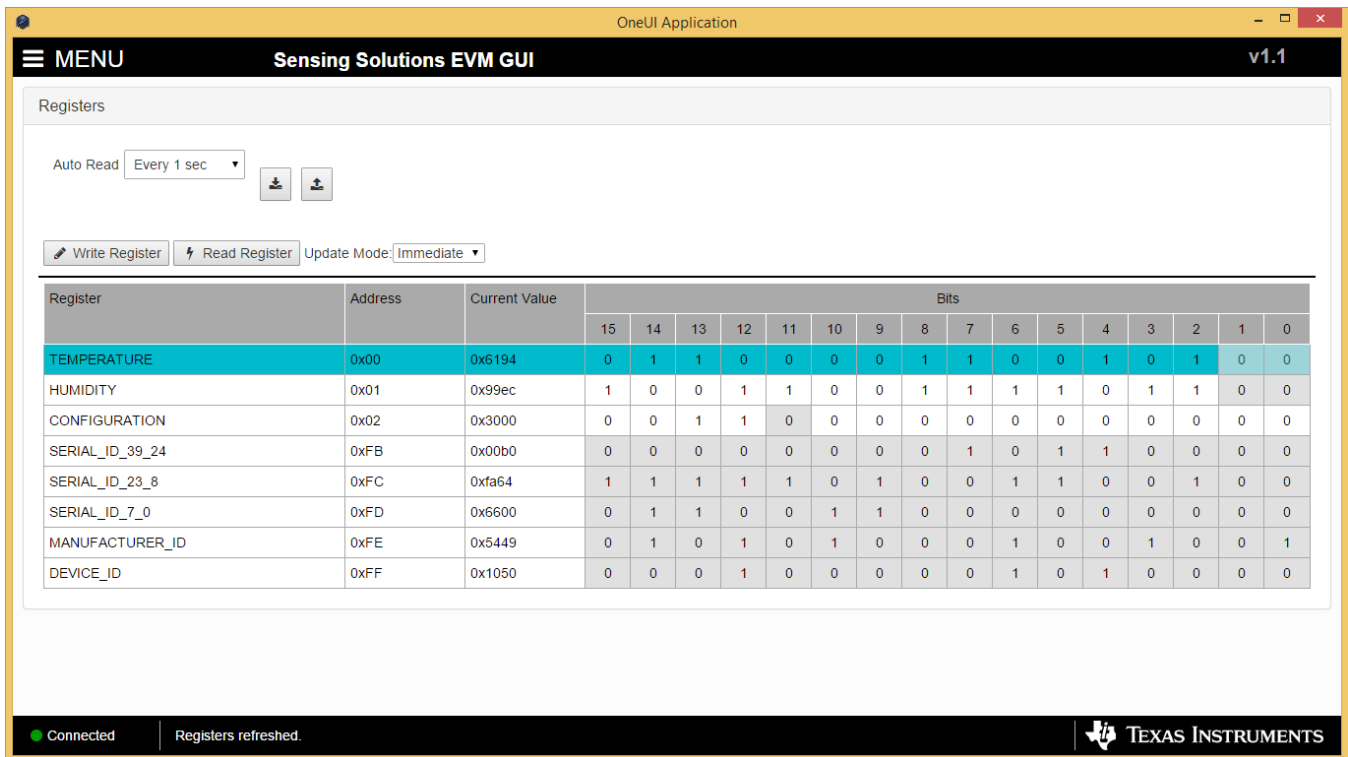

Figure 25. Selecting a Register on Register Page

2. Click the “Read Register” button to update the selected register’s current value and bit values in the table

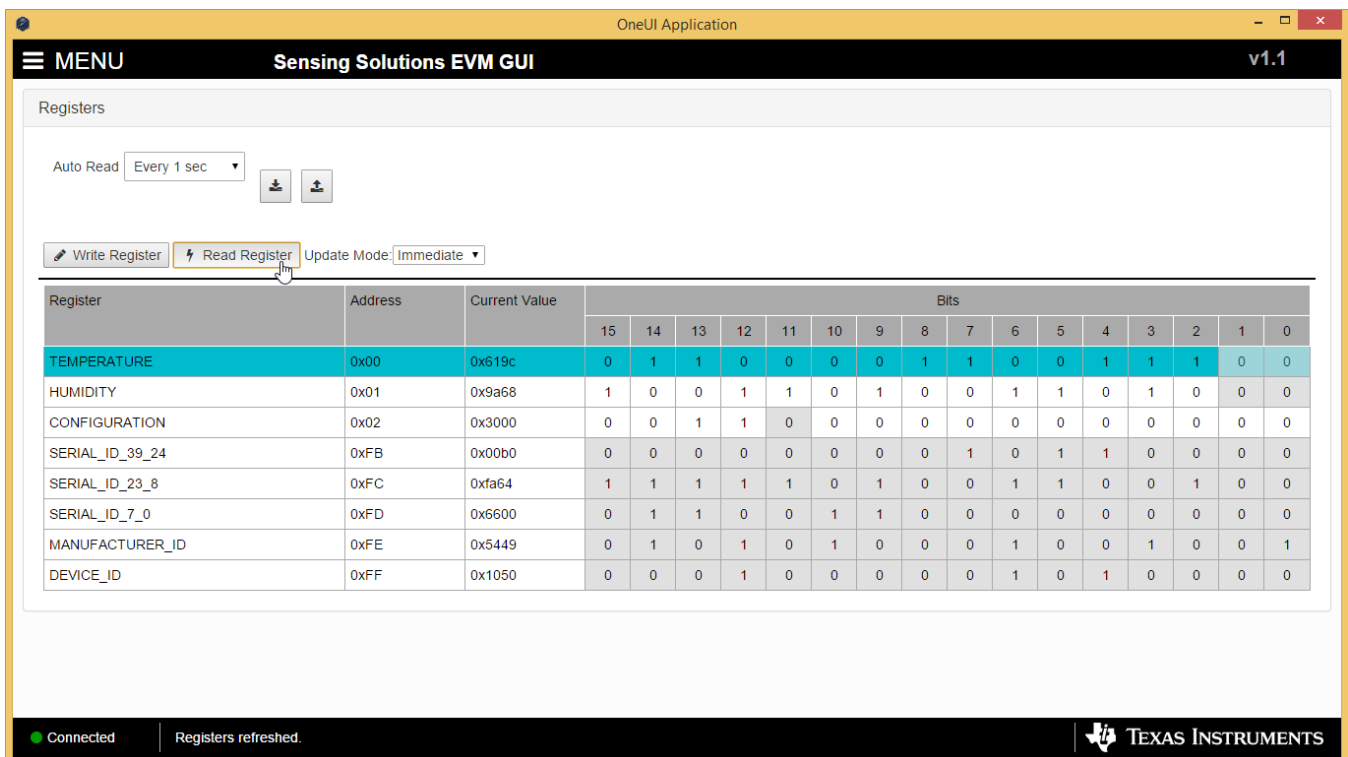

Figure 26. Reading the Current Device Register Value on Register Page

3.4.4 Saving Device Configuration

To save the current register settings of the device follow these steps.

1. Click the button immediately right to the “Auto-Read” selection dropdown

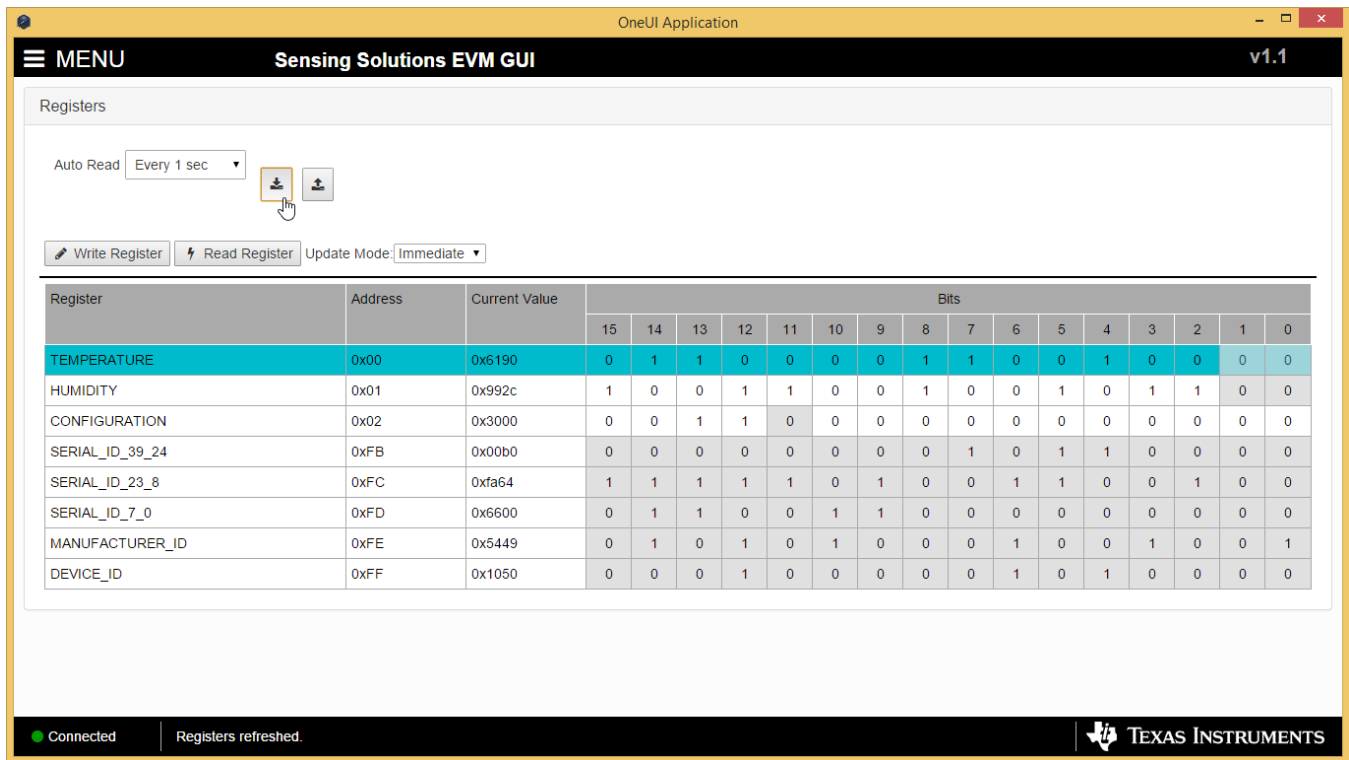

Figure 27. Save Register Values to File on Register Page

2. Choose a JSON file name and the directory to save it within. Then click “Save”

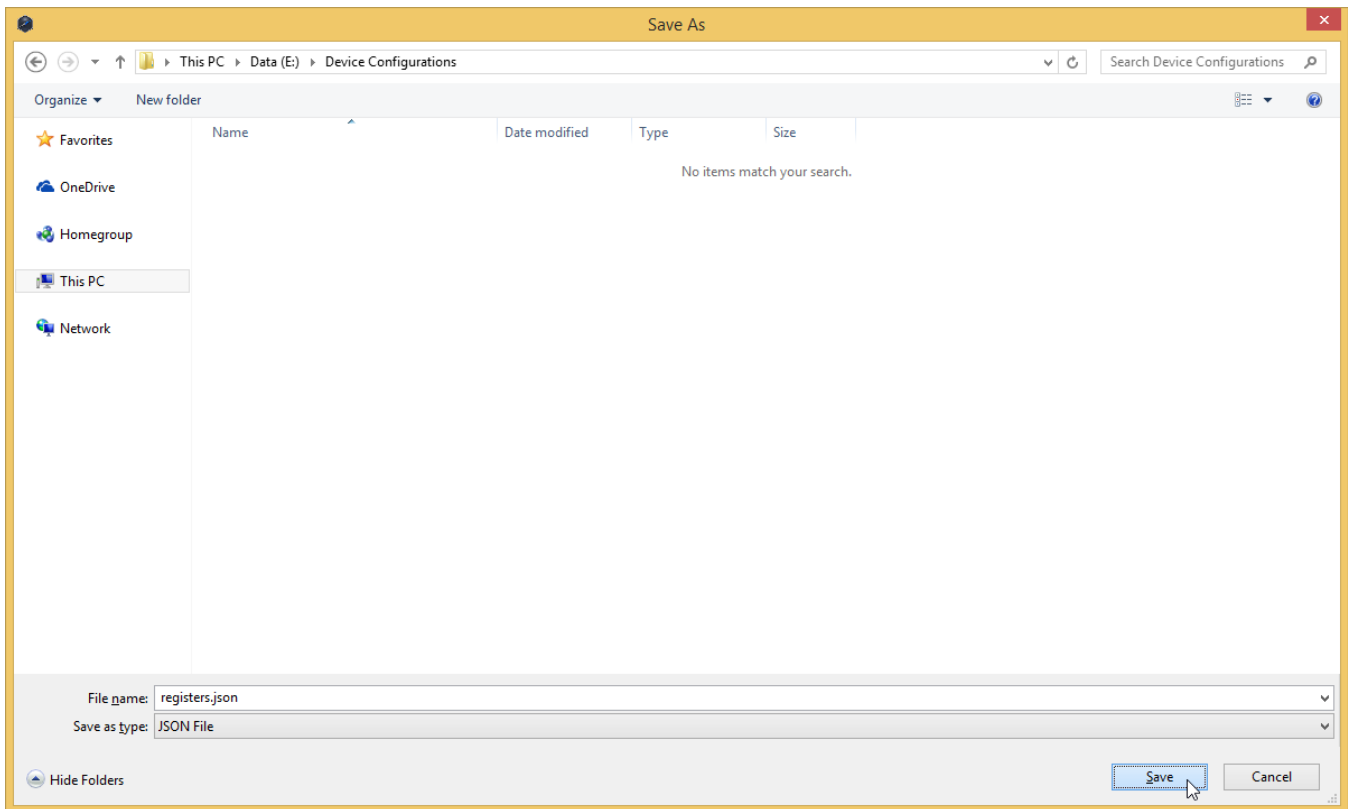

Figure 28. Choosing a JSON File Name to Save Register Values

3.4.5 Loading Previously Saved Device Configuration

To load previously saved register settings from a JSON file follow these steps.

1. Click the button furthest right from the “Auto-Read” selection dropdown

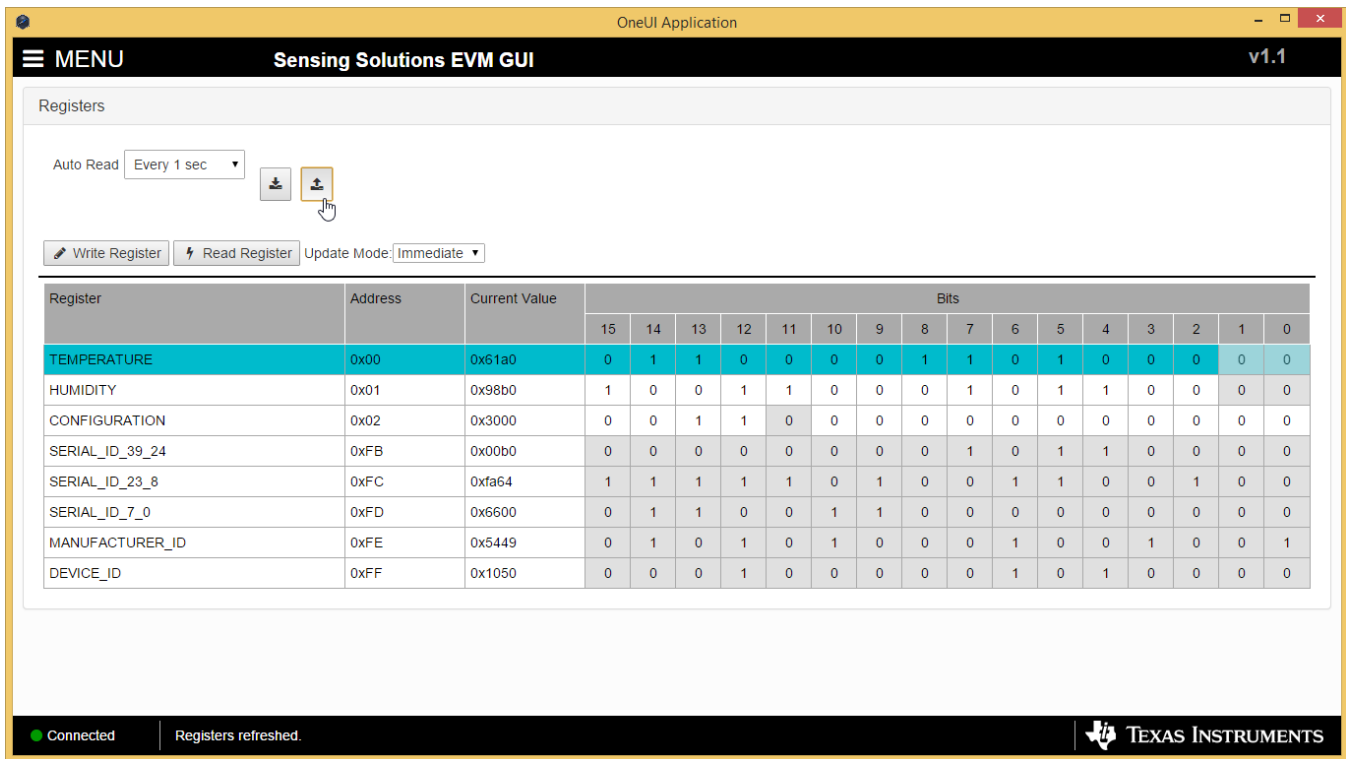

Figure 29. Loading Previously Saved Register Values from File on Register Page

2. Select the JSON file with the desired settings and click “Open”

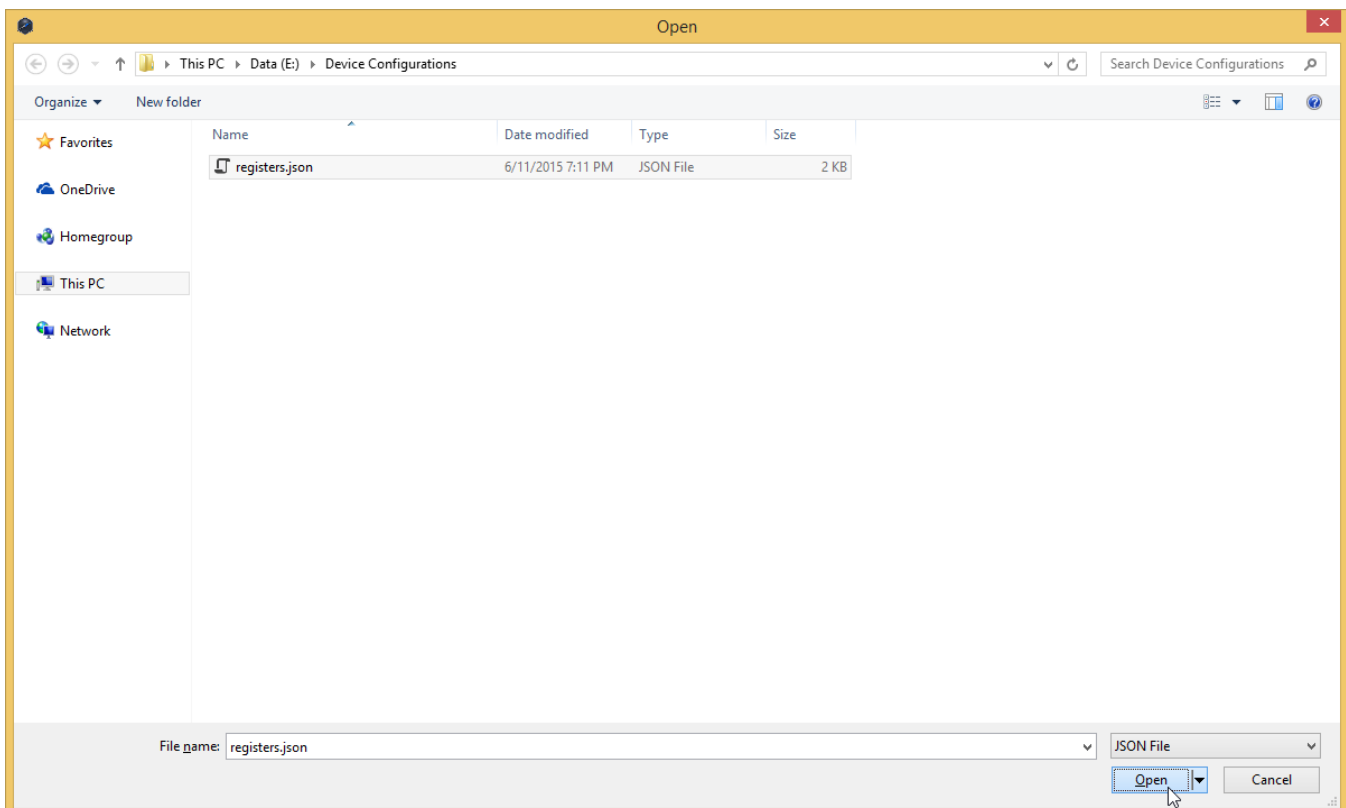

Figure 30. Selecting Previously Save Register Value JSON File

3.5 Configuring the Device using Configuration Page

The Sensing Solutions GUI is capable on configuring the device more intuitively than the direct register values. For more information about configuring the HDC1050 please reference the device datasheet.

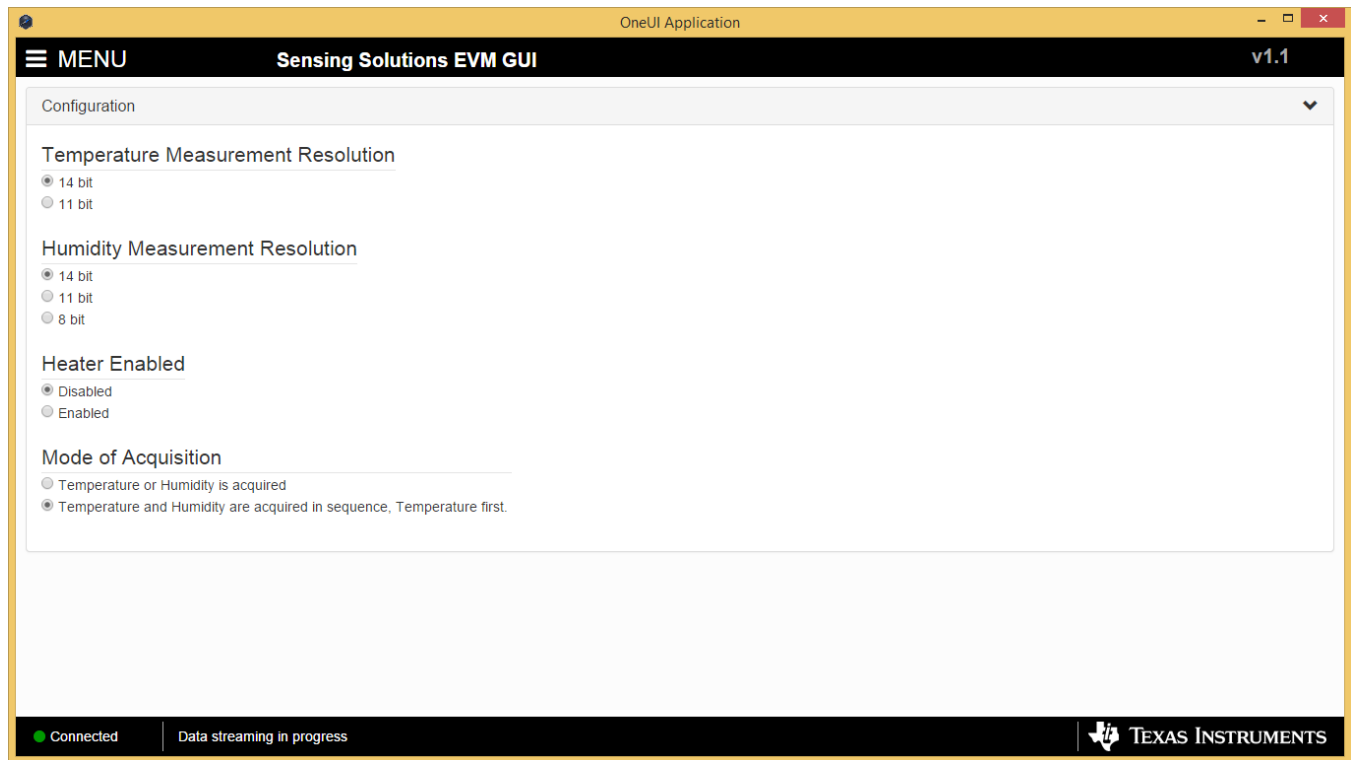

Figure 31. HDC1050 GUI Configuration Page

3.6 Streaming Measurement Data

The Sensing Solutions GUI and EVM provide a tool to capture measurement data at rates up to 500Hz. The section describes how to use the data measurement tools from the "Data Streaming" page accessible from the GUI menu.

3.6.1 Choosing Graph Units and Visible Channels

Select the drop down menu on top of the y-axis to choose the units of the graph. Available options include: Temperature and Humidity, and Raw Code.

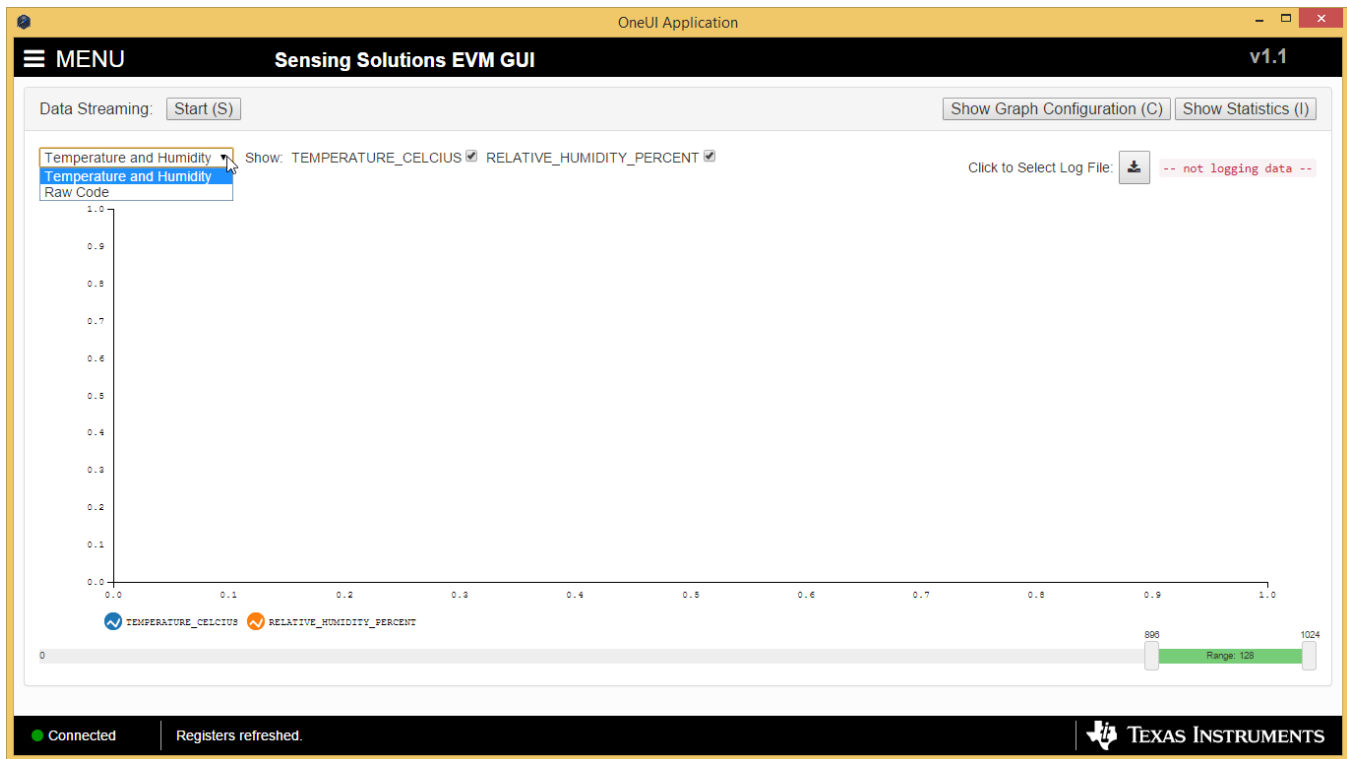

Figure 32. Selecting the Measurement Units for the Data Streaming Graph

To select which measurements are displayed in the graph, check or uncheck the temperature and relative humidity boxes shown next to the graph units. Selecting or not selecting the data types only affects the graph and not the data logged to a file. If a data type is not enabled in the Configuration page it will not appear on the Data Streaming page.

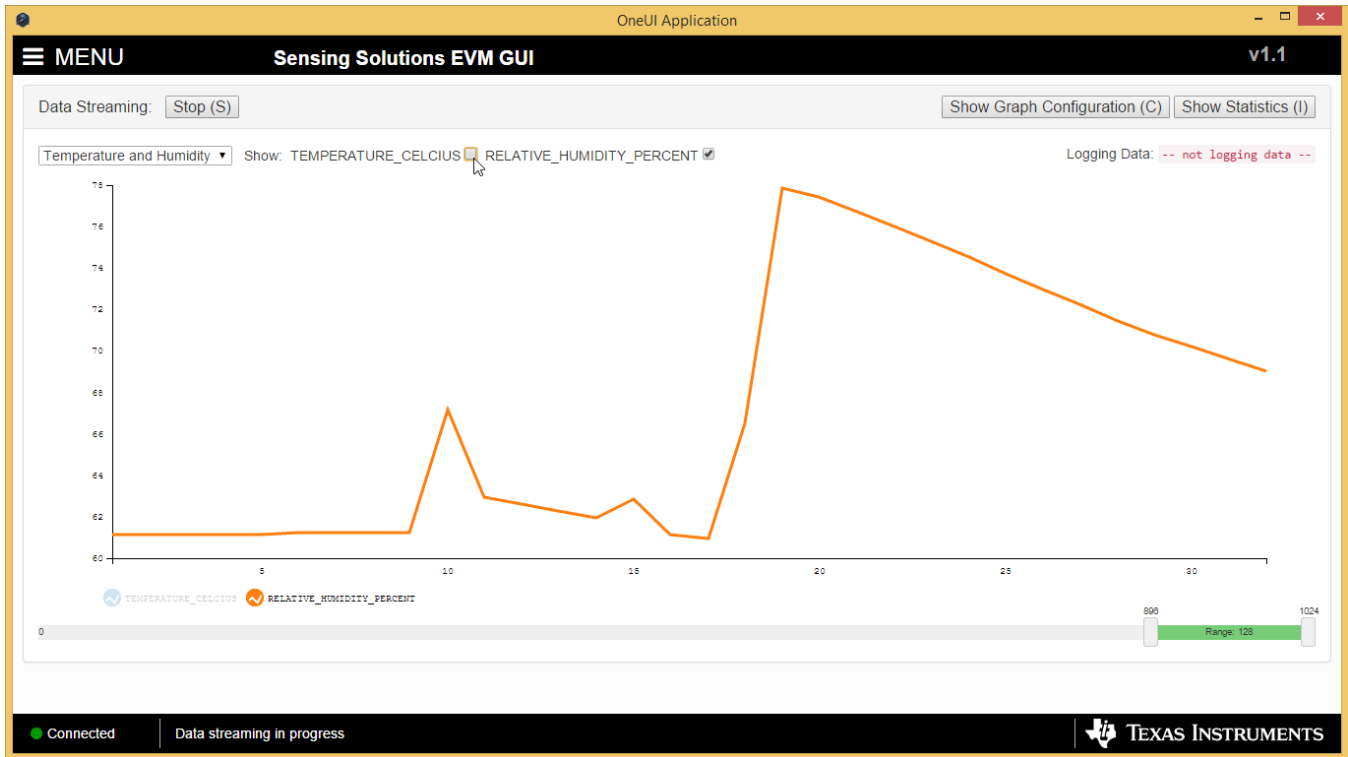

Figure 33. Data Streaming Graph Showing Only Relative Humidity Percent

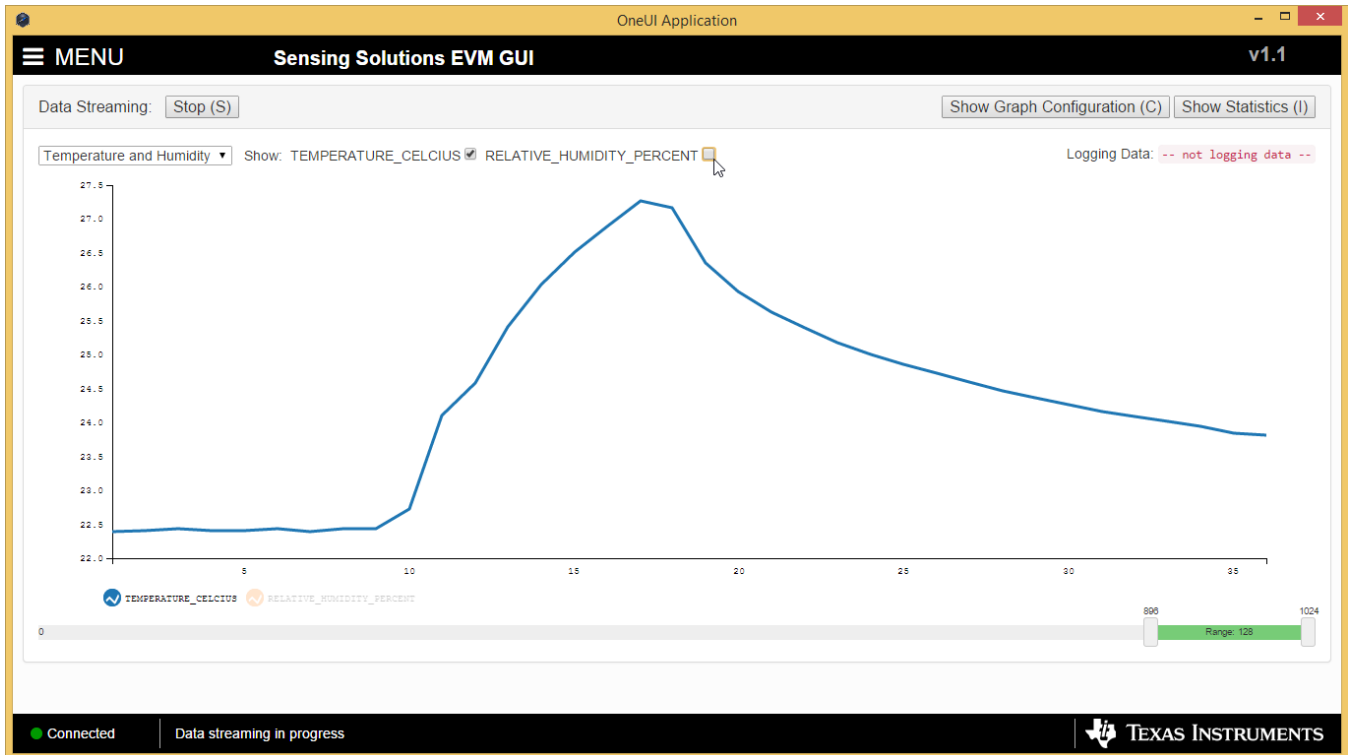

Figure 34. Data Streaming Graph Showing Only Temperature

3.6.2 Logging data to a file

Follow these steps to log measurement data to a file.

1. Click the button in the upper right under next to "Click to Select Log File"

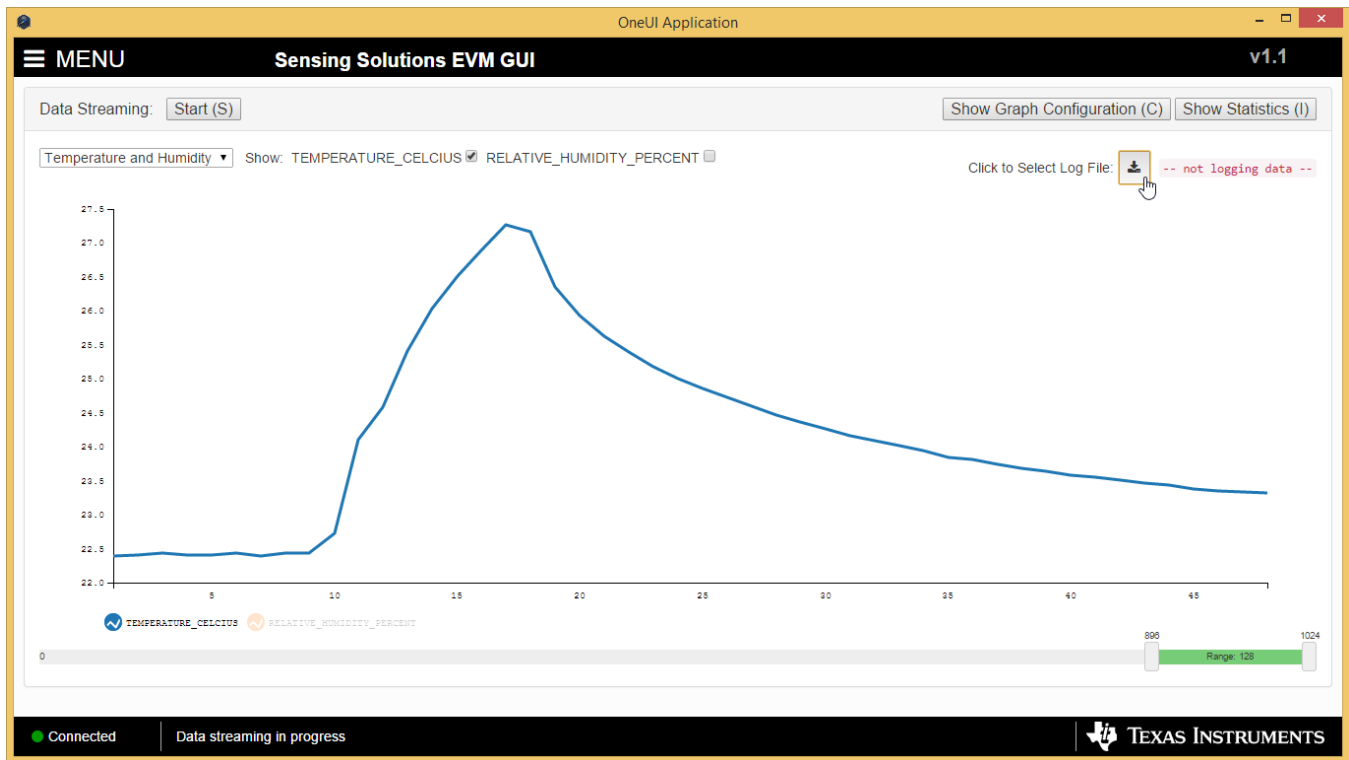

Figure 35. Select Log File Button on Data Streaming Page

2. Select a file name and directory to save the data to and then click the "Save" button

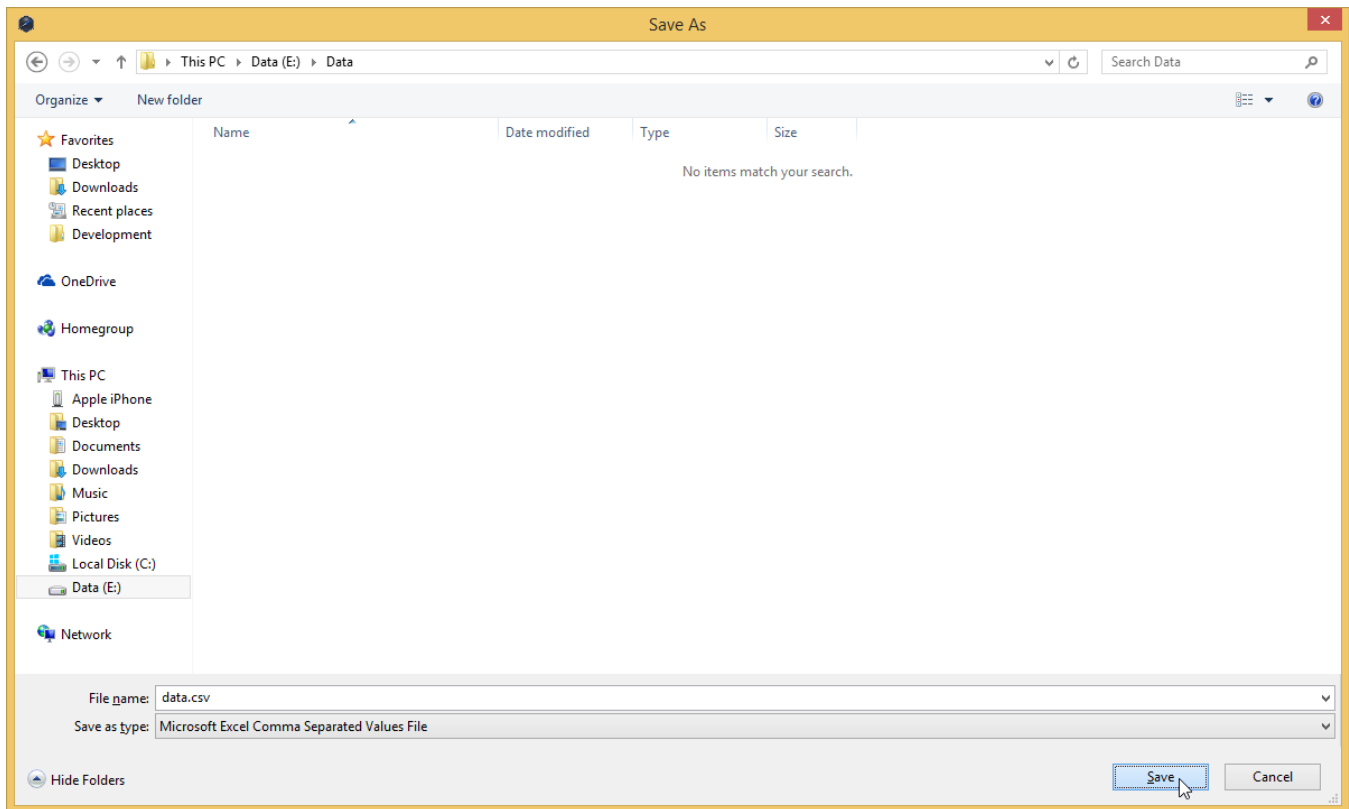

Figure 36. Selecting the Log File for Data Streaming

3.6.3 Setting the vertical axis scale and sampling rate

To set the vertical axis scale or change the sampling rate follow these steps.

1. Click the “Show Graph Configuration” button

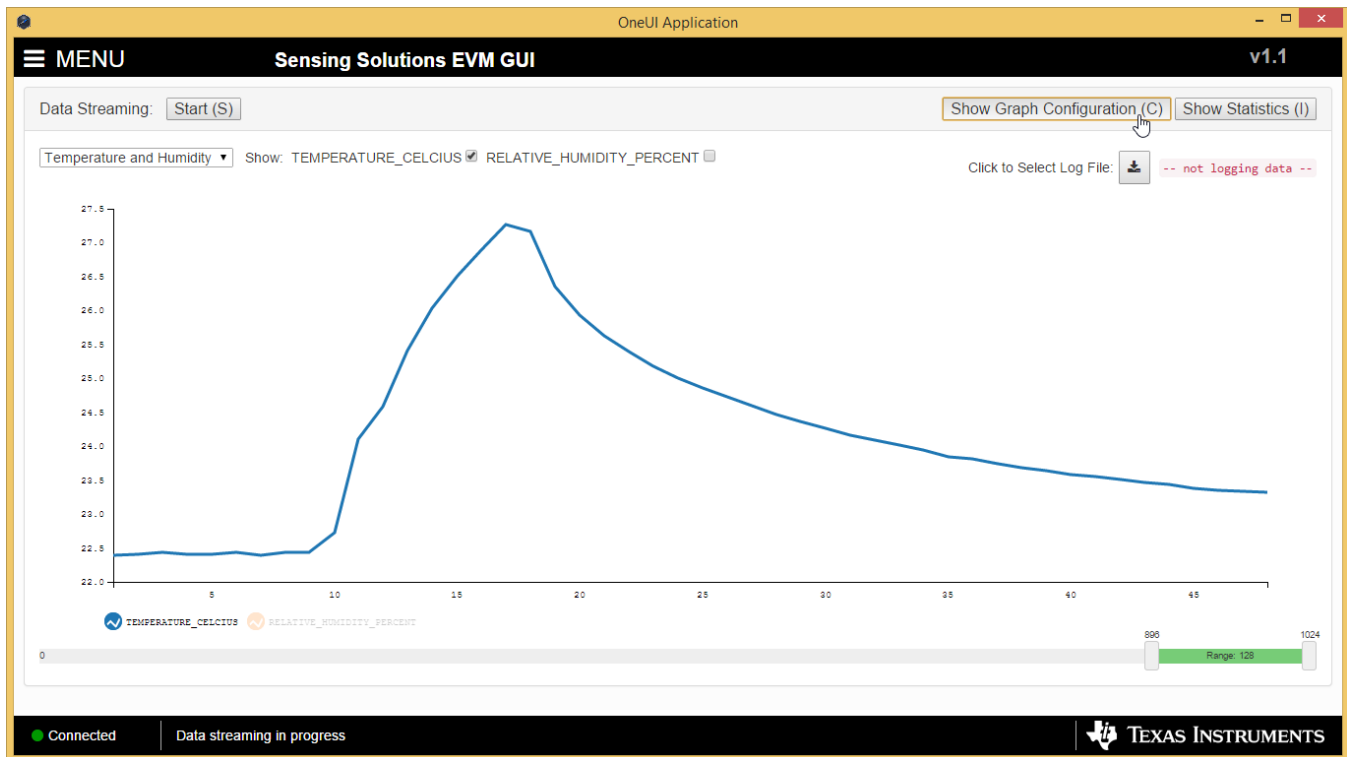

Figure 37. Show Graph Configuration Button on Data Streaming Page

2. The sampling rate can be adjusted in the "Sampling Rate" table.
 - Note that the GUI sampling rate affects only the graph and logging rate but not the actual device sampling rate

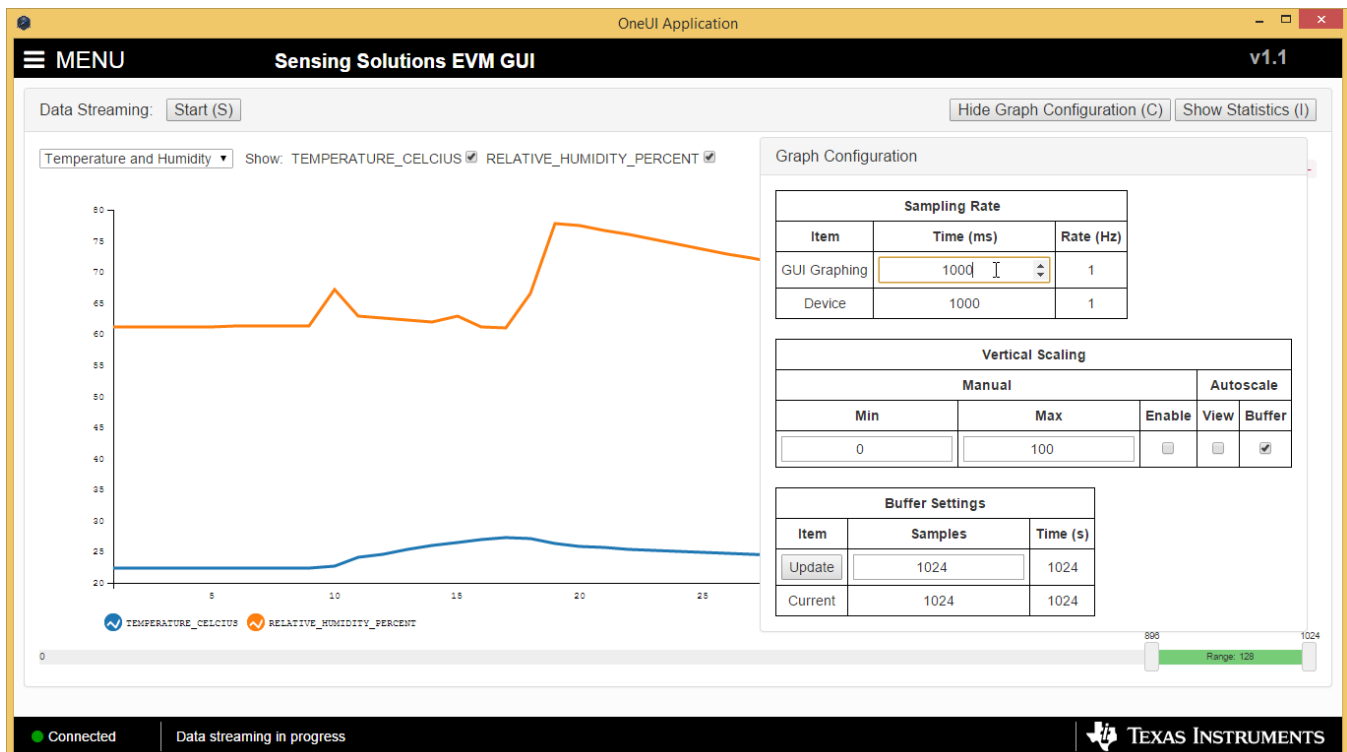

Figure 38. Setting the Data Streaming Sample Rate to 1 Second

- The vertical scaling can be automatically updated or manually controlled by selecting either checkboxes in the “Vertical Scaling” table

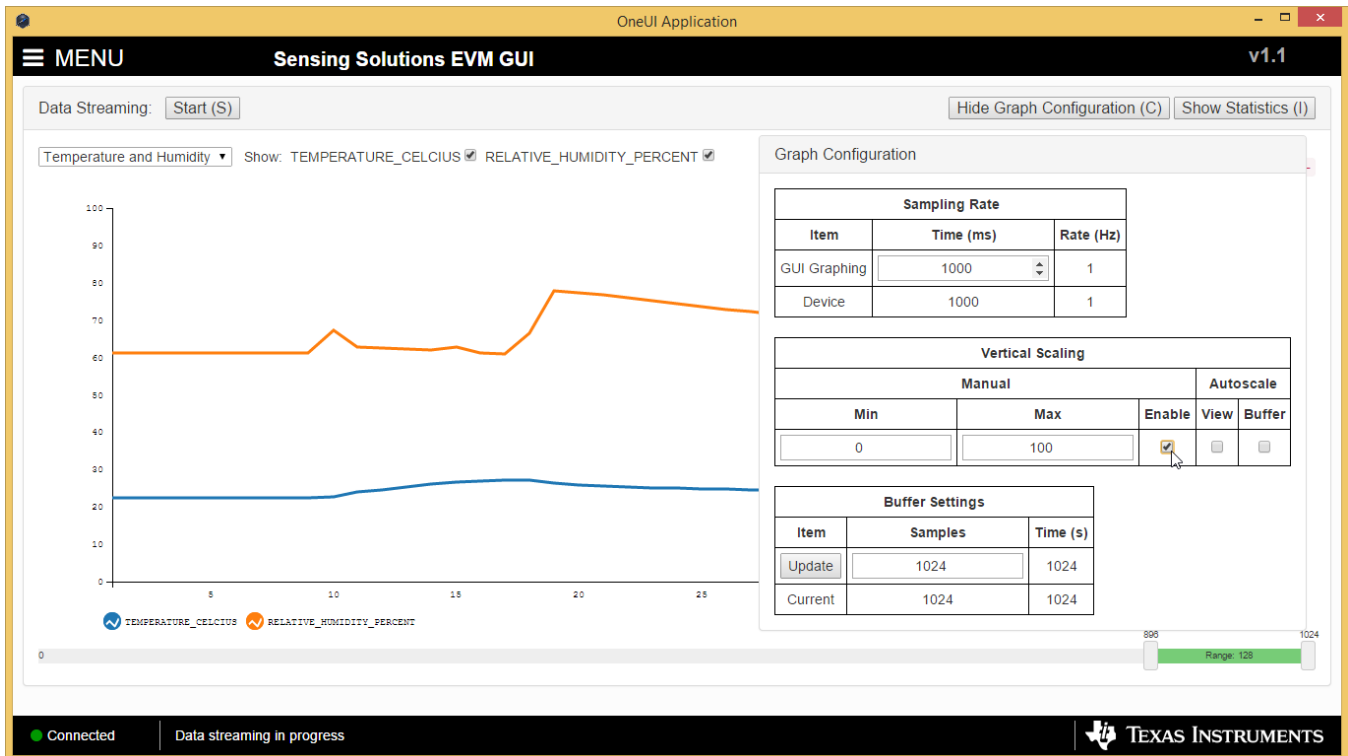

Figure 39. Manually Setting the Vertical Scale on Data Streaming Graph

3.6.4 Starting and Stopping Measurement Data Acquisition

To start data streaming click the “Start” button.



Figure 40. Starting Data Acquisition on Data Streaming Graph

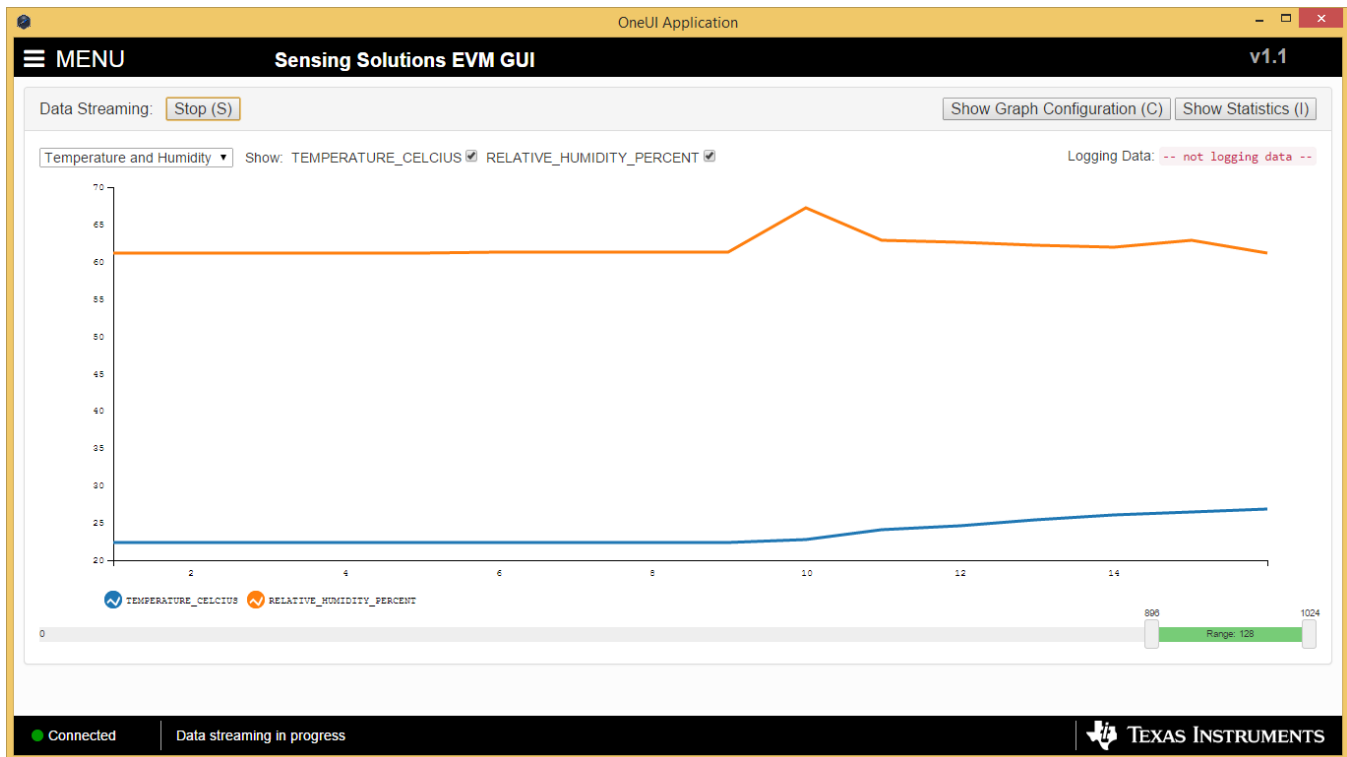

Figure 41. Data Acquisition In Progress on Data Streaming Page

To stop data streaming click the “Stop” button.

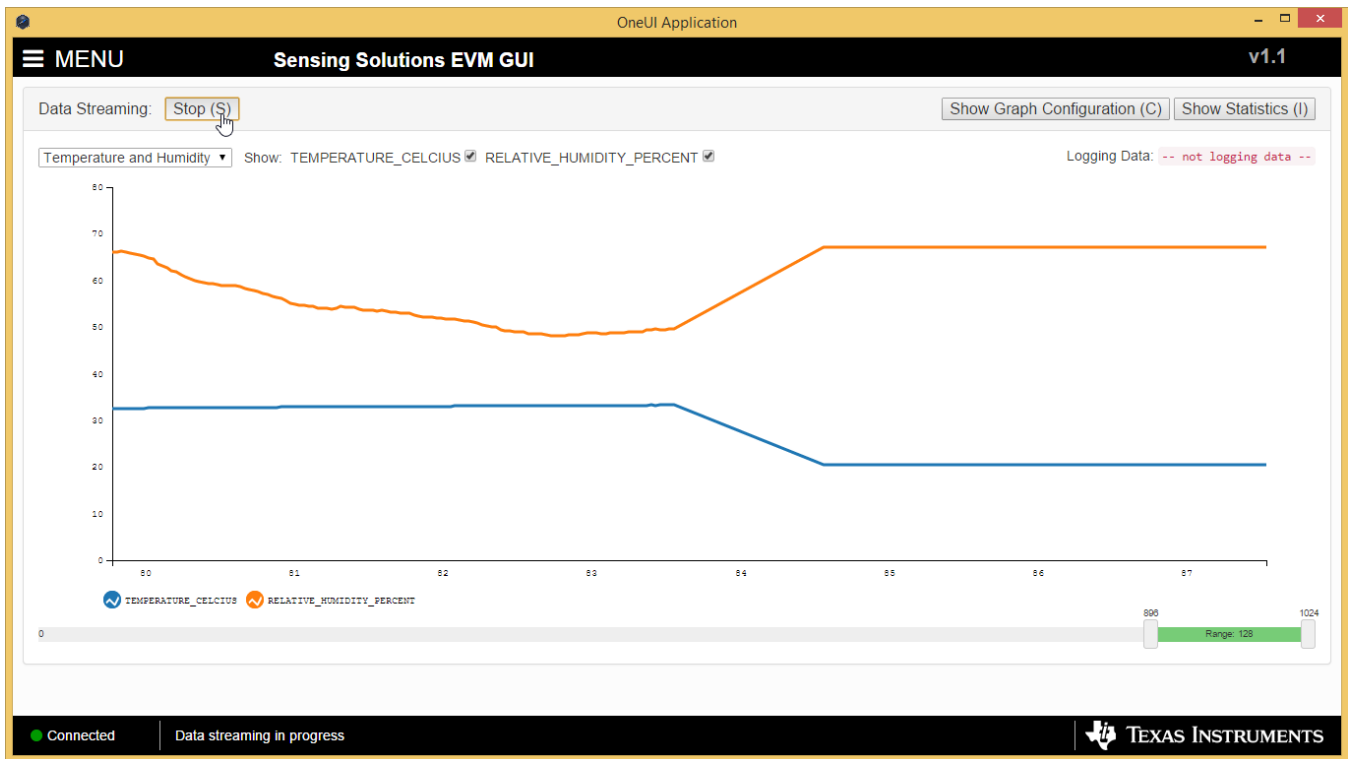

Figure 42. Stopping Data Acquisition on Data Streaming Graph

3.6.5 Displaying Measurement Data Statistics

Click the “Show Statistics” button to view the measurement statistics.

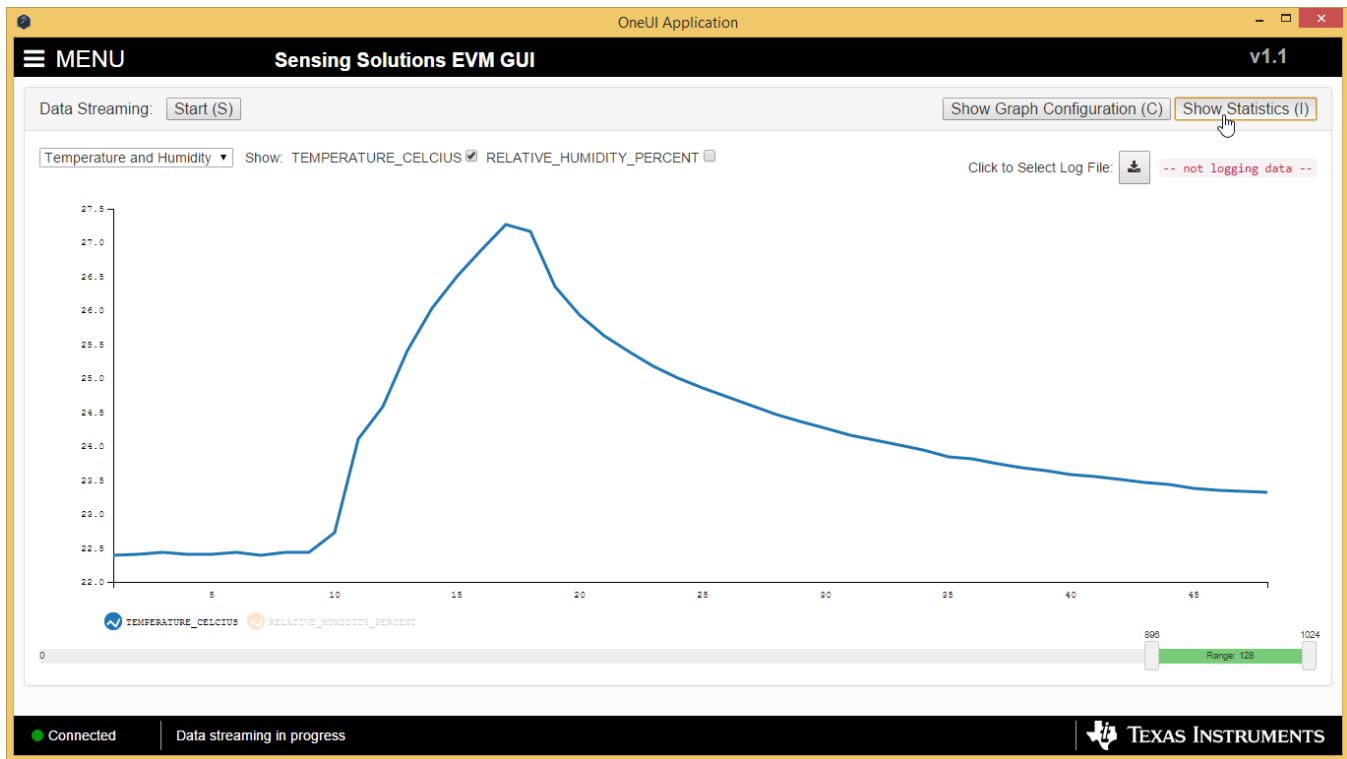

Figure 43. Show Statistics Button on Data Streaming Graph

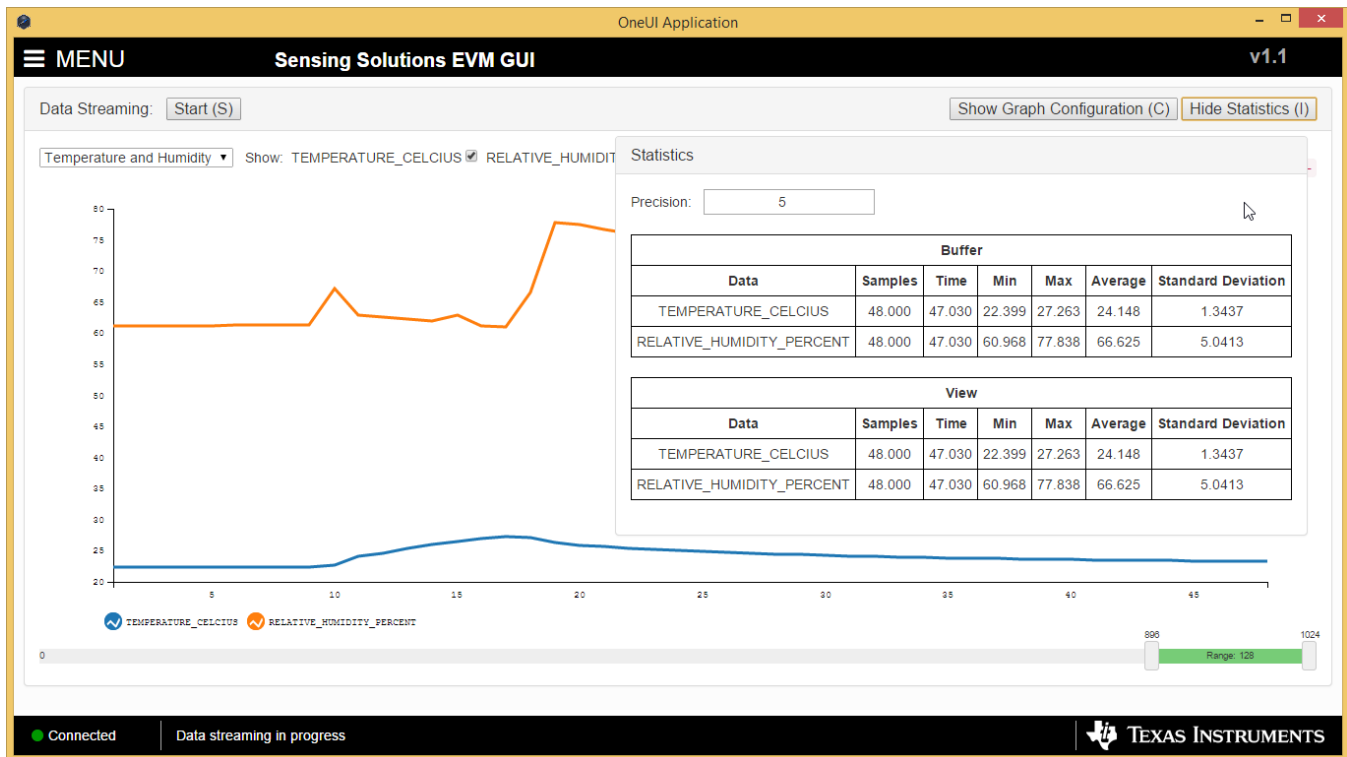

Figure 44. Data Statistics on Data Streaming Graph

3.6.6 Navigating the GUI's Data Buffer

After stopping the data stream, the number of data samples displayed can be selected by moving the dual slider under the graph.

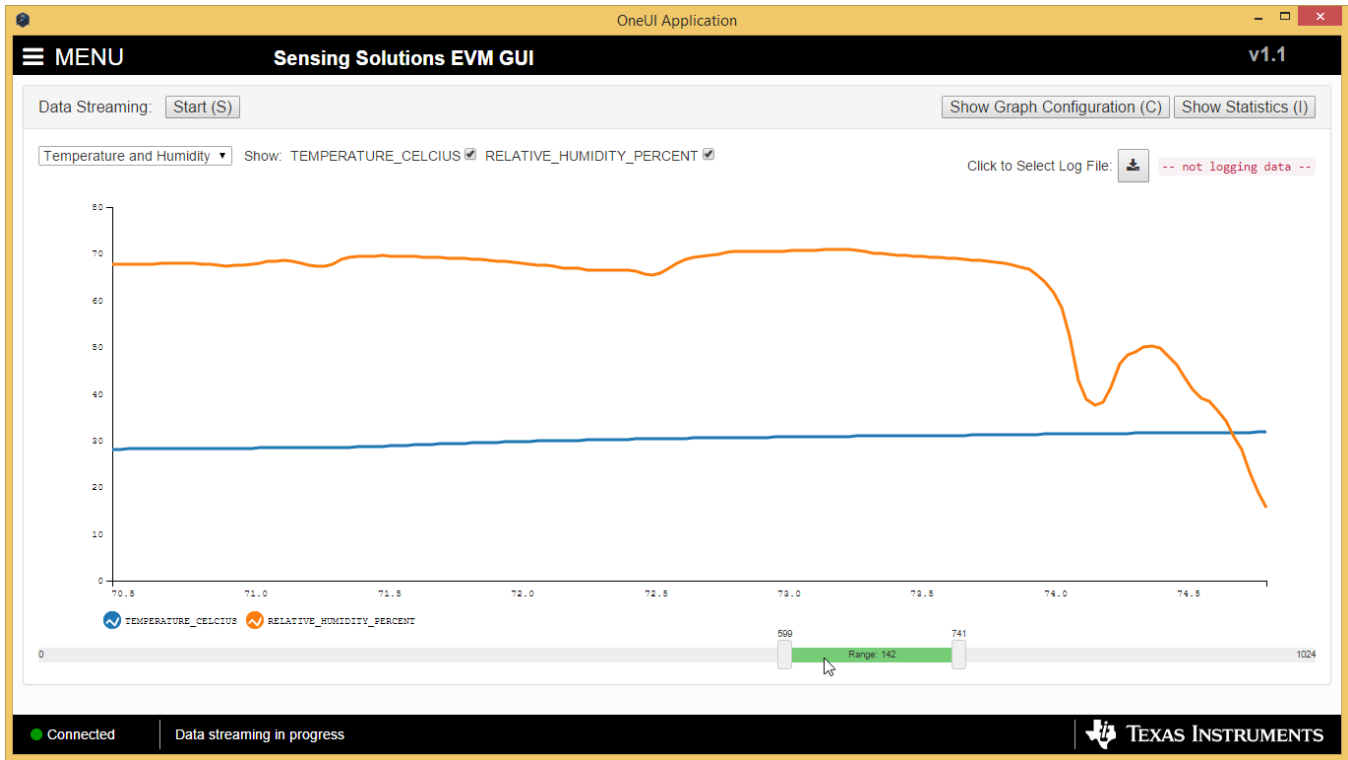

Figure 45. Moving the Data Graph Sample View



Figure 46. Viewing the Entire Buffer on Data Graph

3.7 Updating the EVM Firmware

To upload new firmware to the EVM, navigate to the "Firmware" page from the GUI menu and follow these steps.

1. Click the button to select a TI-TXT firmware file

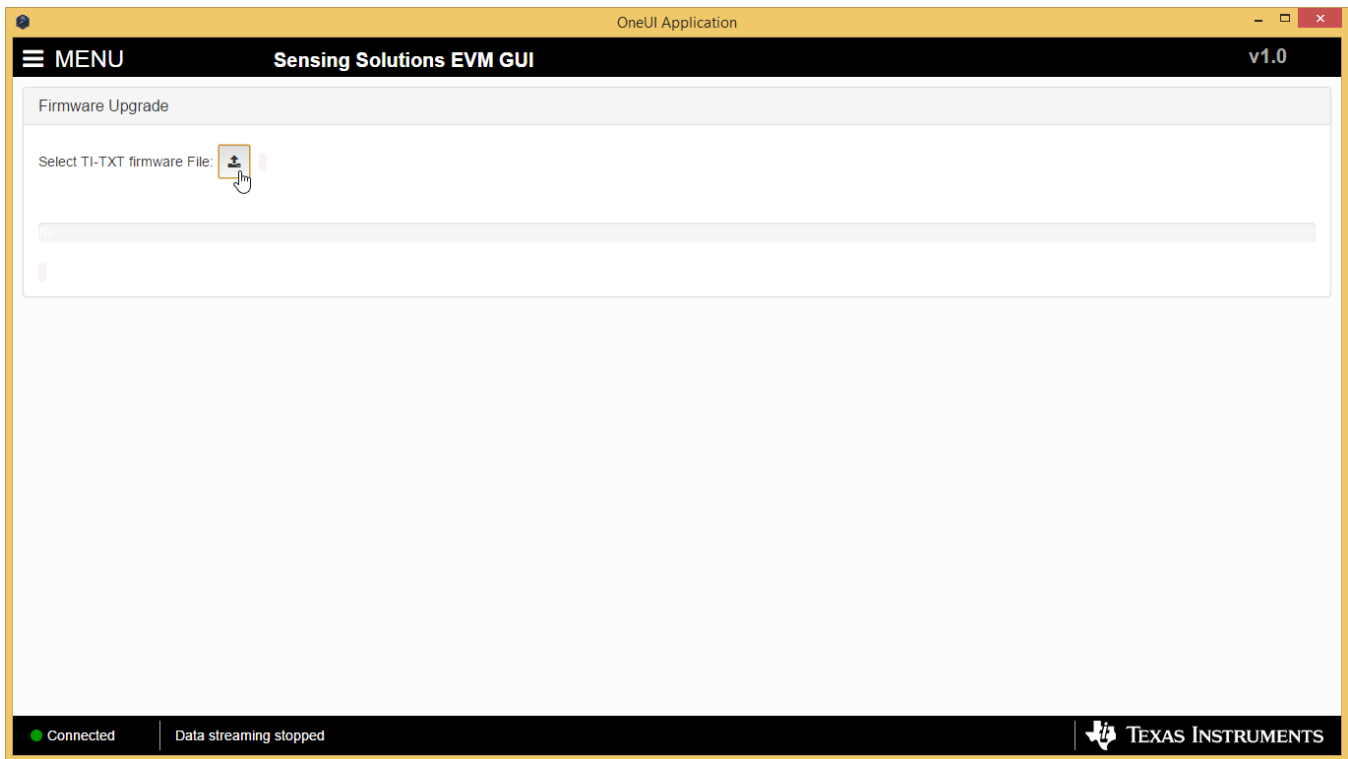

Figure 47. Select TI-TXT File Button on Firmware Upload Page

2. Select the firmware file and click “Open”

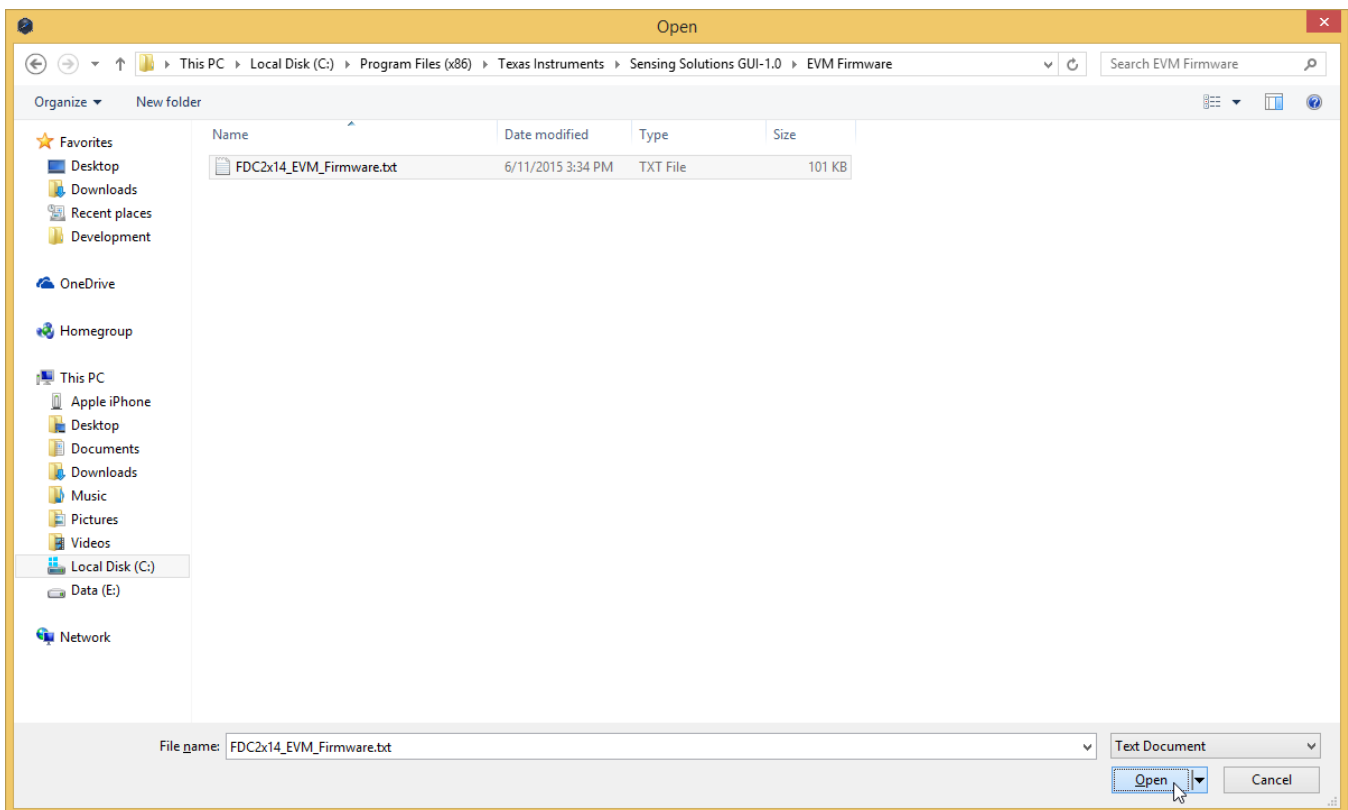

Figure 48. Selecting TI-TXT Firmware File for Upload to EVM

3. Click the “Upload Firmware” button

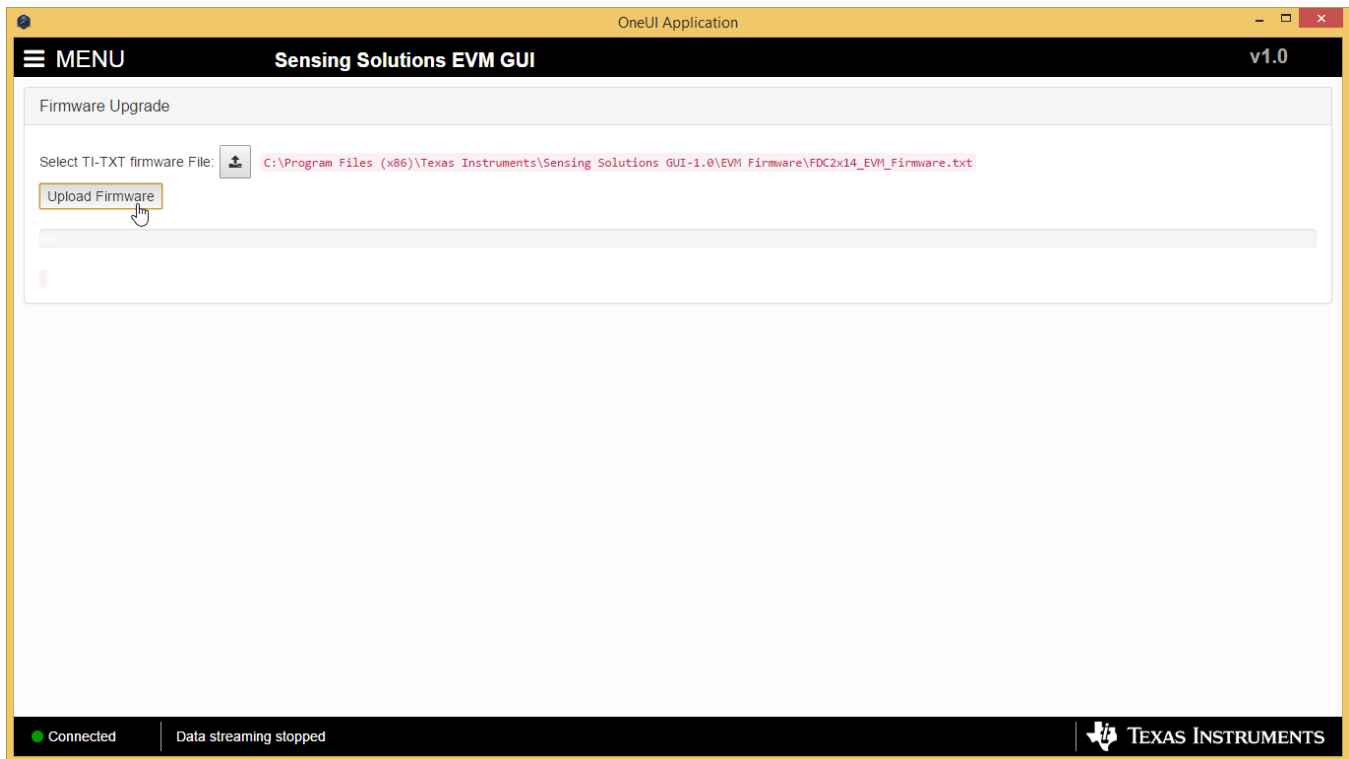

Figure 49. Upload Firmware Button on Firmware Upload Page

4. Wait for the firmware to upload. Do NOT disconnect the EVM from the PC at this time! Also note that the GUI will disconnect from the EVM. The upload process should not take more than one minute.

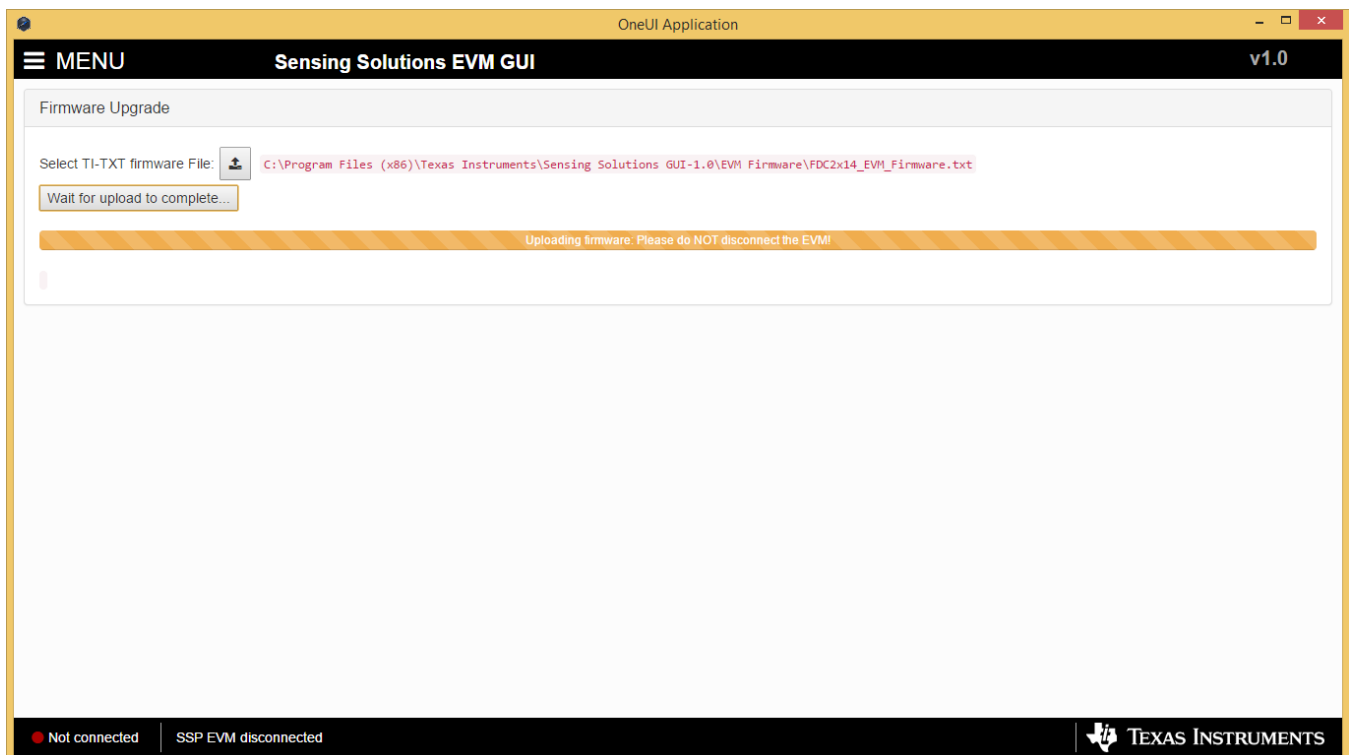

Figure 50. Firmware Upload in Progress

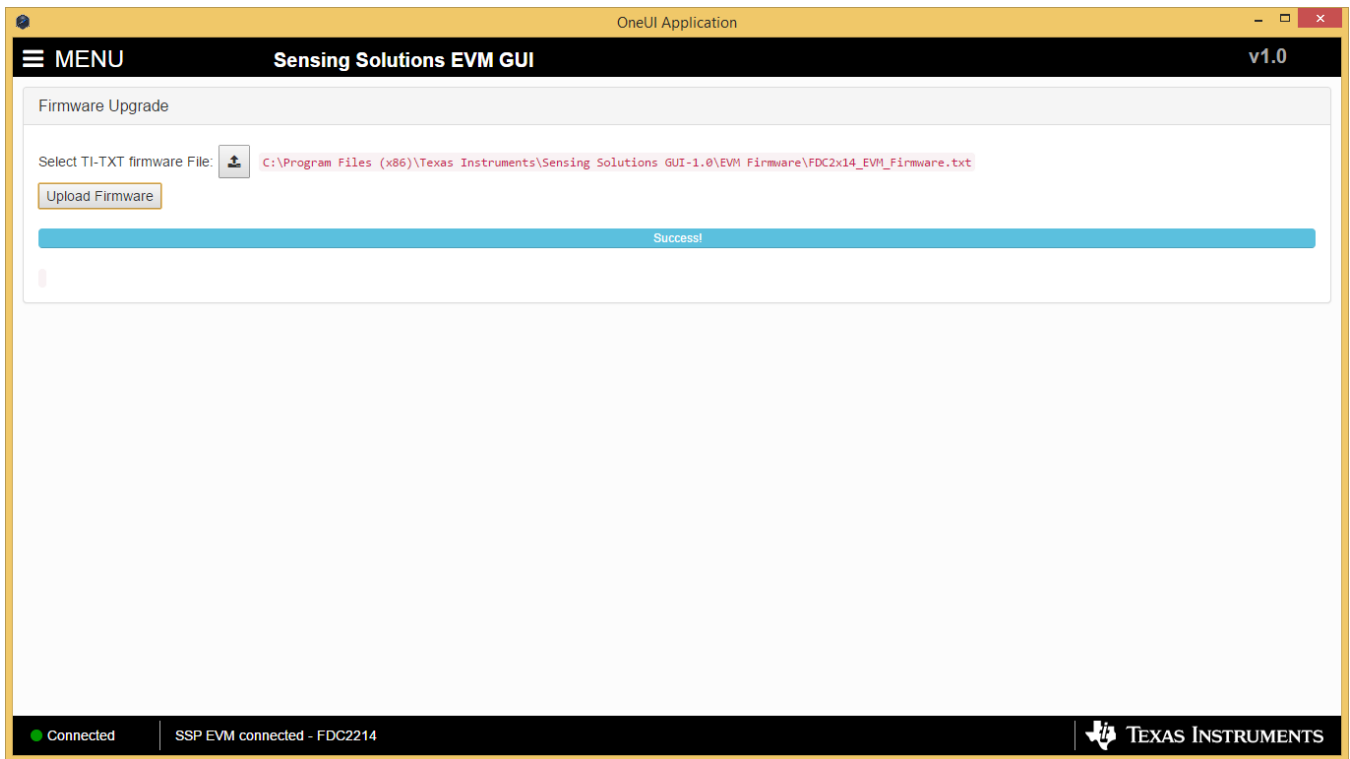

Figure 51. Firmware Upload Success

4 Board Layout

Figure 52 and Figure 53 show the board layout for the HDC1050EVM. Note that the DAP pad on the HDC1050 is grounded on the EVM, but in most system designs, should be left floating (not contacted with GND) to reduce the influence of the PCB thermals on the temperature measurement.

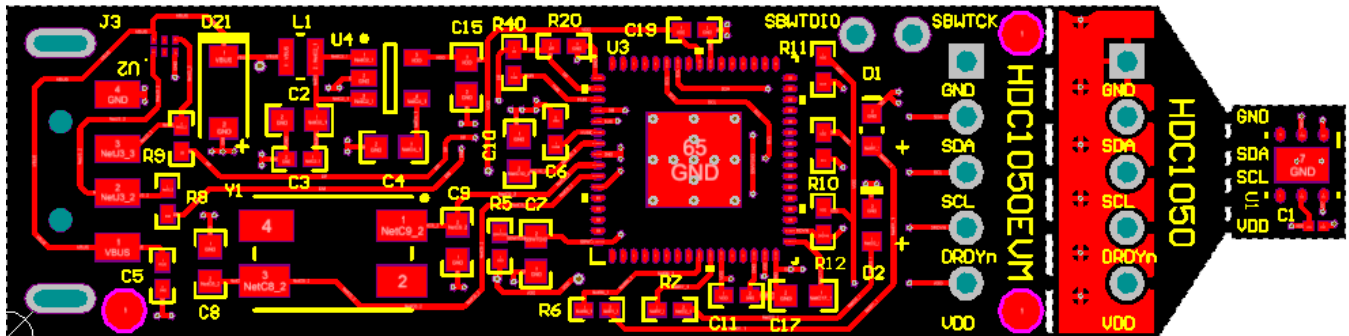

Figure 52. Top Layer Routing

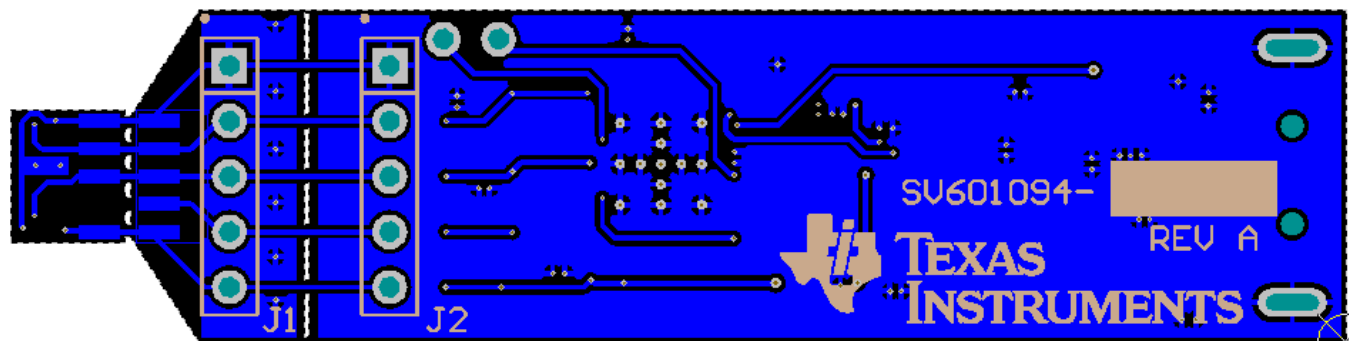

Figure 53. Bottom Layer Routing

5 Schematic

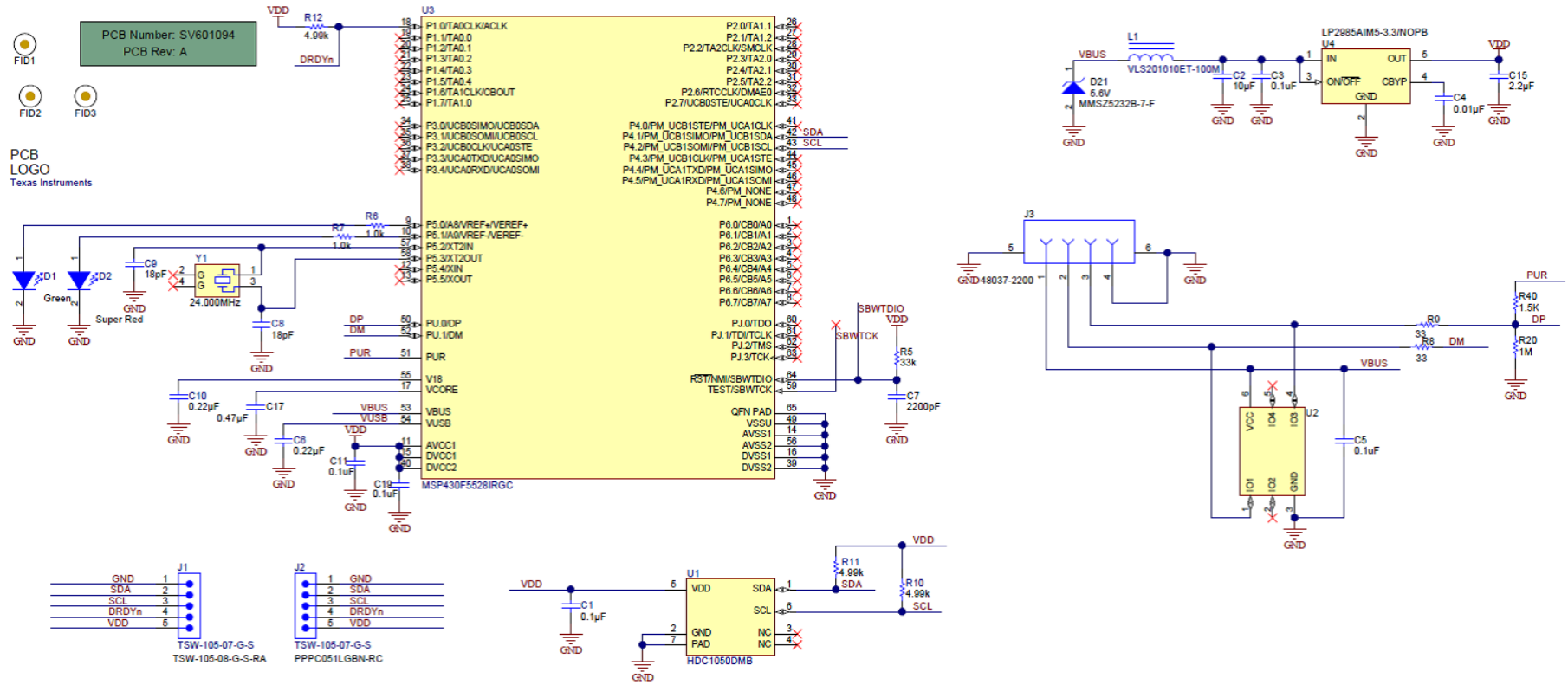

Figure 54. HDC1050EVM Schematic

6 HDC1050EVM Bill of Materials

Part Number	Description	Designator	Footprint	Quantity
CL03A104KP3NNNC	CAP, CERM, 0.1uF, 10V, +/-10%, X5R, 0201	C1	0201	1
C1608X5R1A106M	CAP, CERM, 10uF, 10V, +/-20%, X5R, 0603	C2	0603	1
GRM155R71C104JA88D	CAP CER 0.1UF 16V 5% X7R 0402	C3, C5, C11, C19	0402	4
C1608C0G1E103J	CAP, CERM, 0.01uF, 25V, +/-5%, C0G/NP0, 0603	C4	0603	1
GRM155R71C224KA12D	CAP, CERM, 0.22uF, 16V, +/-10%, X7R, 0402	C6	0402	1
C0603X222K5RACTU	CAP, CERM, 2200pF, 50V, +/-10%, X7R, 0603	C7	0603	1
GRM1885C2A180JA01D	CAP, CERM, 18pF, 100V, +/-5%, C0G/NP0, 0603	C8, C9	0603	2
06033D224KAT2A	CAP, CERM, 0.22uF, 25V, +/-10%, X5R, 0603	C10	0603	1
C0603C225K8PACTU	CAP, CERM, 2.2uF, 10V, +/-10%, X5R, 0603	C15	0603	1
C0603C474K8RACTU	CAP, CERM, 0.47uF, 10V, +/-10%, X7R, 0603	C17	0603	1
LG L29K-G2J1-24-Z	LED, Green, SMD	D1	LG L29K_GREEN	1
SML-LX0603SRW-TR	LED, Super Red, SMD	D2	SML-LX0603SRW_SuperRed	1
MMSZ5232B-7-F	Diode, Zener, 5.6V, 500mW, SOD-123	D21	SOD-123	1
Fiducial	Fiducial mark. There is nothing to buy or mount.	FID1, FID2, FID3	Fiducial10-20	3
TSW-105-07-G-S	Header, TH, 100mil, 5x1, Gold plated, 230 mil above insulator	J1, J2	TSW-105-07-G-S	2
48037-2200	Connector, USB Type A, 4POS R/A, SMD	J3	CONN_USB_0480372200	1
VLS201610ET-100M	Inductor, Shielded, Ferrite, 10uH, 0.4A, 1.38 ohm, SMD	L1	VLS201610	1
CRCW040233K0JNED	RES, 33k ohm, 5%, 0.063W, 0402	R5	0402	1
CRCW04021K00JNED	RES, 1.0k ohm, 5%, 0.063W, 0402	R6, R7	0402	2
CRCW040233R0JNED	RES, 33 ohm, 5%, 0.063W, 0402	R8, R9	0402	2
CRCW04024K99FKED	RES, 4.99k ohm, 1%, 0.063W, 0402	R10, R11, R12	0402	3
RC0402JR-071ML	RES, 1M ohm, 5%, 0.063W, 0402	R20	0402	1
CRCW04021K50JNED	RES 1.5K OHM 1/16W 5% 0402 SMD	R40	0402	1
HDC1050DMB	Humidity Sensor, DMB0006A	U1	DMB0006A_NV	1
TPD4E004DRY	4-CHANNEL ESD-PROTECTION ARRAY FOR HIGH-SPEED DATA INTERFACES, DRY006A	U2	DRY0006A	1
MSP430F5528IRGC	Mixed Signal MicroController, RGC0064B	U3	RGC0064B	1
LP2985AIM5-3.3/NOPB	Micropower 150 mA Low-Noise Ultra Low-Dropout Regulator, 5-pin SOT-23, Pb-Free	U4	MF05A_N	1
ABMM-24.000MHZ-B2-T	Crystal, 24.000MHz, 18pF, SMD	Y1	Abracon_ABMM	1

Revision History

Changes from Original (June 2015) to A Revision	Page
• Added content on new GUI operation.....	10

NOTE: Page numbers for previous revisions may differ from page numbers in the current version.

STANDARD TERMS AND CONDITIONS FOR EVALUATION MODULES

1. *Delivery:* TI delivers TI evaluation boards, kits, or modules, including any accompanying demonstration software, components, or documentation (collectively, an "EVM" or "EVMs") to the User ("User") in accordance with the terms and conditions set forth herein. Acceptance of the EVM is expressly subject to the following terms and conditions.
 - 1.1 EVMs are intended solely for product or software developers for use in a research and development setting to facilitate feasibility evaluation, experimentation, or scientific analysis of TI semiconductors products. EVMs have no direct function and are not finished products. EVMs shall not be directly or indirectly assembled as a part or subassembly in any finished product. For clarification, any software or software tools provided with the EVM ("Software") shall not be subject to the terms and conditions set forth herein but rather shall be subject to the applicable terms and conditions that accompany such Software
 - 1.2 EVMs are not intended for consumer or household use. EVMs may not be sold, sublicensed, leased, rented, loaned, assigned, or otherwise distributed for commercial purposes by Users, in whole or in part, or used in any finished product or production system.
2. *Limited Warranty and Related Remedies/Disclaimers:*
 - 2.1 These terms and conditions do not apply to Software. The warranty, if any, for Software is covered in the applicable Software License Agreement.
 - 2.2 TI warrants that the TI EVM will conform to TI's published specifications for ninety (90) days after the date TI delivers such EVM to User. Notwithstanding the foregoing, TI shall not be liable for any defects that are caused by neglect, misuse or mistreatment by an entity other than TI, including improper installation or testing, or for any EVMs that have been altered or modified in any way by an entity other than TI. Moreover, TI shall not be liable for any defects that result from User's design, specifications or instructions for such EVMs. Testing and other quality control techniques are used to the extent TI deems necessary or as mandated by government requirements. TI does not test all parameters of each EVM.
 - 2.3 If any EVM fails to conform to the warranty set forth above, TI's sole liability shall be at its option to repair or replace such EVM, or credit User's account for such EVM. TI's liability under this warranty shall be limited to EVMs that are returned during the warranty period to the address designated by TI and that are determined by TI not to conform to such warranty. If TI elects to repair or replace such EVM, TI shall have a reasonable time to repair such EVM or provide replacements. Repaired EVMs shall be warranted for the remainder of the original warranty period. Replaced EVMs shall be warranted for a new full ninety (90) day warranty period.
3. *Regulatory Notices:*
 - 3.1 *United States*
 - 3.1.1 *Notice applicable to EVMs not FCC-Approved:*

This kit is designed to allow product developers to evaluate electronic components, circuitry, or software associated with the kit to determine whether to incorporate such items in a finished product and software developers to write software applications for use with the end product. This kit is not a finished product and when assembled may not be resold or otherwise marketed unless all required FCC equipment authorizations are first obtained. Operation is subject to the condition that this product not cause harmful interference to licensed radio stations and that this product accept harmful interference. Unless the assembled kit is designed to operate under part 15, part 18 or part 95 of this chapter, the operator of the kit must operate under the authority of an FCC license holder or must secure an experimental authorization under part 5 of this chapter.
 - 3.1.2 *For EVMs annotated as FCC – FEDERAL COMMUNICATIONS COMMISSION Part 15 Compliant:*

CAUTION

This device complies with part 15 of the FCC Rules. Operation is subject to the following two conditions: (1) This device may not cause harmful interference, and (2) this device must accept any interference received, including interference that may cause undesired operation.

Changes or modifications not expressly approved by the party responsible for compliance could void the user's authority to operate the equipment.

FCC Interference Statement for Class A EVM devices

NOTE: This equipment has been tested and found to comply with the limits for a Class A digital device, pursuant to part 15 of the FCC Rules. These limits are designed to provide reasonable protection against harmful interference when the equipment is operated in a commercial environment. This equipment generates, uses, and can radiate radio frequency energy and, if not installed and used in accordance with the instruction manual, may cause harmful interference to radio communications. Operation of this equipment in a residential area is likely to cause harmful interference in which case the user will be required to correct the interference at his own expense.

FCC Interference Statement for Class B EVM devices

NOTE: This equipment has been tested and found to comply with the limits for a Class B digital device, pursuant to part 15 of the FCC Rules. These limits are designed to provide reasonable protection against harmful interference in a residential installation. This equipment generates, uses and can radiate radio frequency energy and, if not installed and used in accordance with the instructions, may cause harmful interference to radio communications. However, there is no guarantee that interference will not occur in a particular installation. If this equipment does cause harmful interference to radio or television reception, which can be determined by turning the equipment off and on, the user is encouraged to try to correct the interference by one or more of the following measures:

- Reorient or relocate the receiving antenna.
- Increase the separation between the equipment and receiver.
- Connect the equipment into an outlet on a circuit different from that to which the receiver is connected.
- Consult the dealer or an experienced radio/TV technician for help.

3.2 Canada

3.2.1 For EVMs issued with an Industry Canada Certificate of Conformance to RSS-210

Concerning EVMs Including Radio Transmitters:

This device complies with Industry Canada license-exempt RSS standard(s). Operation is subject to the following two conditions: (1) this device may not cause interference, and (2) this device must accept any interference, including interference that may cause undesired operation of the device.

Concernant les EVMs avec appareils radio:

Le présent appareil est conforme aux CNR d'Industrie Canada applicables aux appareils radio exempts de licence. L'exploitation est autorisée aux deux conditions suivantes: (1) l'appareil ne doit pas produire de brouillage, et (2) l'utilisateur de l'appareil doit accepter tout brouillage radioélectrique subi, même si le brouillage est susceptible d'en compromettre le fonctionnement.

Concerning EVMs Including Detachable Antennas:

Under Industry Canada regulations, this radio transmitter may only operate using an antenna of a type and maximum (or lesser) gain approved for the transmitter by Industry Canada. To reduce potential radio interference to other users, the antenna type and its gain should be so chosen that the equivalent isotropically radiated power (e.i.r.p.) is not more than that necessary for successful communication. This radio transmitter has been approved by Industry Canada to operate with the antenna types listed in the user guide with the maximum permissible gain and required antenna impedance for each antenna type indicated. Antenna types not included in this list, having a gain greater than the maximum gain indicated for that type, are strictly prohibited for use with this device.

Concernant les EVMs avec antennes détachables

Conformément à la réglementation d'Industrie Canada, le présent émetteur radio peut fonctionner avec une antenne d'un type et d'un gain maximal (ou inférieur) approuvé pour l'émetteur par Industrie Canada. Dans le but de réduire les risques de brouillage radioélectrique à l'intention des autres utilisateurs, il faut choisir le type d'antenne et son gain de sorte que la puissance isotrope rayonnée équivalente (p.i.r.e.) ne dépasse pas l'intensité nécessaire à l'établissement d'une communication satisfaisante. Le présent émetteur radio a été approuvé par Industrie Canada pour fonctionner avec les types d'antenne énumérés dans le manuel d'usage et ayant un gain admissible maximal et l'impédance requise pour chaque type d'antenne. Les types d'antenne non inclus dans cette liste, ou dont le gain est supérieur au gain maximal indiqué, sont strictement interdits pour l'exploitation de l'émetteur

3.3 Japan

3.3.1 *Notice for EVMs delivered in Japan:* Please see http://www.tij.co.jp/lstds/ti_ja/general/eStore/notice_01.page 日本国内に輸入される評価用キット、ボードについては、次のところをご覧ください。
http://www.tij.co.jp/lstds/ti_ja/general/eStore/notice_01.page

3.3.2 *Notice for Users of EVMs Considered "Radio Frequency Products" in Japan:* EVMs entering Japan may not be certified by TI as conforming to Technical Regulations of Radio Law of Japan.

If User uses EVMs in Japan, not certified to Technical Regulations of Radio Law of Japan, User is required by Radio Law of Japan to follow the instructions below with respect to EVMs:

1. Use EVMs in a shielded room or any other test facility as defined in the notification #173 issued by Ministry of Internal Affairs and Communications on March 28, 2006, based on Sub-section 1.1 of Article 6 of the Ministry's Rule for Enforcement of Radio Law of Japan,
2. Use EVMs only after User obtains the license of Test Radio Station as provided in Radio Law of Japan with respect to EVMs, or
3. Use of EVMs only after User obtains the Technical Regulations Conformity Certification as provided in Radio Law of Japan with respect to EVMs. Also, do not transfer EVMs, unless User gives the same notice above to the transferee. Please note that if User does not follow the instructions above, User will be subject to penalties of Radio Law of Japan.

【無線電波を送信する製品の開発キットをお使いになる際の注意事項】 開発キットの中には技術基準適合証明を受けていないものがあります。技術適合証明を受けていないものご使用に際しては、電波法遵守のため、以下のいずれかの措置を取っていただく必要がありますのでご注意ください。

1. 電波法施行規則第6条第1項第1号に基づく平成18年3月28日総務省告示第173号で定められた電波暗室等の試験設備でご使用いただく。
2. 実験局の免許を取得後ご使用いただく。
3. 技術基準適合証明を取得後ご使用いただく。

なお、本製品は、上記の「ご使用にあたっての注意」を譲渡先、移転先に通知しない限り、譲渡、移転できないものとします。

上記を遵守頂けない場合は、電波法の罰則が適用される可能性があることをご留意ください。日本テキサス・インスツルメンツ株式会社
東京都新宿区西新宿 6 丁目 2 4 番 1 号
西新宿三井ビル

3.3.3 *Notice for EVMs for Power Line Communication:* Please see http://www.tij.co.jp/llds/ti_ja/general/eStore/notice_02.page
電力線搬送波通信についての開発キットをお使いになる際の注意事項については、次のところをご覧ください。http://www.tij.co.jp/llds/ti_ja/general/eStore/notice_02.page

4 *EVM Use Restrictions and Warnings:*

4.1 EVMS ARE NOT FOR USE IN FUNCTIONAL SAFETY AND/OR SAFETY CRITICAL EVALUATIONS, INCLUDING BUT NOT LIMITED TO EVALUATIONS OF LIFE SUPPORT APPLICATIONS.

4.2 User must read and apply the user guide and other available documentation provided by TI regarding the EVM prior to handling or using the EVM, including without limitation any warning or restriction notices. The notices contain important safety information related to, for example, temperatures and voltages.

4.3 *Safety-Related Warnings and Restrictions:*

4.3.1 User shall operate the EVM within TI's recommended specifications and environmental considerations stated in the user guide, other available documentation provided by TI, and any other applicable requirements and employ reasonable and customary safeguards. Exceeding the specified performance ratings and specifications (including but not limited to input and output voltage, current, power, and environmental ranges) for the EVM may cause personal injury or death, or property damage. If there are questions concerning performance ratings and specifications, User should contact a TI field representative prior to connecting interface electronics including input power and intended loads. Any loads applied outside of the specified output range may also result in unintended and/or inaccurate operation and/or possible permanent damage to the EVM and/or interface electronics. Please consult the EVM user guide prior to connecting any load to the EVM output. If there is uncertainty as to the load specification, please contact a TI field representative. During normal operation, even with the inputs and outputs kept within the specified allowable ranges, some circuit components may have elevated case temperatures. These components include but are not limited to linear regulators, switching transistors, pass transistors, current sense resistors, and heat sinks, which can be identified using the information in the associated documentation. When working with the EVM, please be aware that the EVM may become very warm.

4.3.2 EVMs are intended solely for use by technically qualified, professional electronics experts who are familiar with the dangers and application risks associated with handling electrical mechanical components, systems, and subsystems. User assumes all responsibility and liability for proper and safe handling and use of the EVM by User or its employees, affiliates, contractors or designees. User assumes all responsibility and liability to ensure that any interfaces (electronic and/or mechanical) between the EVM and any human body are designed with suitable isolation and means to safely limit accessible leakage currents to minimize the risk of electrical shock hazard. User assumes all responsibility and liability for any improper or unsafe handling or use of the EVM by User or its employees, affiliates, contractors or designees.

4.4 User assumes all responsibility and liability to determine whether the EVM is subject to any applicable international, federal, state, or local laws and regulations related to User's handling and use of the EVM and, if applicable, User assumes all responsibility and liability for compliance in all respects with such laws and regulations. User assumes all responsibility and liability for proper disposal and recycling of the EVM consistent with all applicable international, federal, state, and local requirements.

5. *Accuracy of Information:* To the extent TI provides information on the availability and function of EVMs, TI attempts to be as accurate as possible. However, TI does not warrant the accuracy of EVM descriptions, EVM availability or other information on its websites as accurate, complete, reliable, current, or error-free.

6. *Disclaimers:*
- 6.1 EXCEPT AS SET FORTH ABOVE, EVMS AND ANY WRITTEN DESIGN MATERIALS PROVIDED WITH THE EVM (AND THE DESIGN OF THE EVM ITSELF) ARE PROVIDED "AS IS" AND "WITH ALL FAULTS." TI DISCLAIMS ALL OTHER WARRANTIES, EXPRESS OR IMPLIED, REGARDING SUCH ITEMS, INCLUDING BUT NOT LIMITED TO ANY IMPLIED WARRANTIES OF MERCHANTABILITY OR FITNESS FOR A PARTICULAR PURPOSE OR NON-INFRINGEMENT OF ANY THIRD PARTY PATENTS, COPYRIGHTS, TRADE SECRETS OR OTHER INTELLECTUAL PROPERTY RIGHTS.
- 6.2 EXCEPT FOR THE LIMITED RIGHT TO USE THE EVM SET FORTH HEREIN, NOTHING IN THESE TERMS AND CONDITIONS SHALL BE CONSTRUED AS GRANTING OR CONFERRING ANY RIGHTS BY LICENSE, PATENT, OR ANY OTHER INDUSTRIAL OR INTELLECTUAL PROPERTY RIGHT OF TI, ITS SUPPLIERS/LICENSORS OR ANY OTHER THIRD PARTY, TO USE THE EVM IN ANY FINISHED END-USER OR READY-TO-USE FINAL PRODUCT, OR FOR ANY INVENTION, DISCOVERY OR IMPROVEMENT MADE, CONCEIVED OR ACQUIRED PRIOR TO OR AFTER DELIVERY OF THE EVM.
7. *USER'S INDEMNITY OBLIGATIONS AND REPRESENTATIONS.* USER WILL DEFEND, INDEMNIFY AND HOLD TI, ITS LICENSORS AND THEIR REPRESENTATIVES HARMLESS FROM AND AGAINST ANY AND ALL CLAIMS, DAMAGES, LOSSES, EXPENSES, COSTS AND LIABILITIES (COLLECTIVELY, "CLAIMS") ARISING OUT OF OR IN CONNECTION WITH ANY HANDLING OR USE OF THE EVM THAT IS NOT IN ACCORDANCE WITH THESE TERMS AND CONDITIONS. THIS OBLIGATION SHALL APPLY WHETHER CLAIMS ARISE UNDER STATUTE, REGULATION, OR THE LAW OF TORT, CONTRACT OR ANY OTHER LEGAL THEORY, AND EVEN IF THE EVM FAILS TO PERFORM AS DESCRIBED OR EXPECTED.
8. *Limitations on Damages and Liability:*
- 8.1 *General Limitations.* IN NO EVENT SHALL TI BE LIABLE FOR ANY SPECIAL, COLLATERAL, INDIRECT, PUNITIVE, INCIDENTAL, CONSEQUENTIAL, OR EXEMPLARY DAMAGES IN CONNECTION WITH OR ARISING OUT OF THESE TERMS AND CONDITIONS OR THE USE OF THE EVMS PROVIDED HEREUNDER, REGARDLESS OF WHETHER TI HAS BEEN ADVISED OF THE POSSIBILITY OF SUCH DAMAGES. EXCLUDED DAMAGES INCLUDE, BUT ARE NOT LIMITED TO, COST OF REMOVAL OR REINSTALLATION, ANCILLARY COSTS TO THE PROCUREMENT OF SUBSTITUTE GOODS OR SERVICES, RETESTING, OUTSIDE COMPUTER TIME, LABOR COSTS, LOSS OF GOODWILL, LOSS OF PROFITS, LOSS OF SAVINGS, LOSS OF USE, LOSS OF DATA, OR BUSINESS INTERRUPTION. NO CLAIM, SUIT OR ACTION SHALL BE BROUGHT AGAINST TI MORE THAN ONE YEAR AFTER THE RELATED CAUSE OF ACTION HAS OCCURRED.
- 8.2 *Specific Limitations.* IN NO EVENT SHALL TI'S AGGREGATE LIABILITY FROM ANY WARRANTY OR OTHER OBLIGATION ARISING OUT OF OR IN CONNECTION WITH THESE TERMS AND CONDITIONS, OR ANY USE OF ANY TI EVM PROVIDED HEREUNDER, EXCEED THE TOTAL AMOUNT PAID TO TI FOR THE PARTICULAR UNITS SOLD UNDER THESE TERMS AND CONDITIONS WITH RESPECT TO WHICH LOSSES OR DAMAGES ARE CLAIMED. THE EXISTENCE OF MORE THAN ONE CLAIM AGAINST THE PARTICULAR UNITS SOLD TO USER UNDER THESE TERMS AND CONDITIONS SHALL NOT ENLARGE OR EXTEND THIS LIMIT.
9. *Return Policy.* Except as otherwise provided, TI does not offer any refunds, returns, or exchanges. Furthermore, no return of EVM(s) will be accepted if the package has been opened and no return of the EVM(s) will be accepted if they are damaged or otherwise not in a resalable condition. If User feels it has been incorrectly charged for the EVM(s) it ordered or that delivery violates the applicable order, User should contact TI. All refunds will be made in full within thirty (30) working days from the return of the components(s), excluding any postage or packaging costs.
10. *Governing Law:* These terms and conditions shall be governed by and interpreted in accordance with the laws of the State of Texas, without reference to conflict-of-laws principles. User agrees that non-exclusive jurisdiction for any dispute arising out of or relating to these terms and conditions lies within courts located in the State of Texas and consents to venue in Dallas County, Texas. Notwithstanding the foregoing, any judgment may be enforced in any United States or foreign court, and TI may seek injunctive relief in any United States or foreign court.

Mailing Address: Texas Instruments, Post Office Box 655303, Dallas, Texas 75265
Copyright © 2015, Texas Instruments Incorporated

IMPORTANT NOTICE

Texas Instruments Incorporated and its subsidiaries (TI) reserve the right to make corrections, enhancements, improvements and other changes to its semiconductor products and services per JESD46, latest issue, and to discontinue any product or service per JESD48, latest issue. Buyers should obtain the latest relevant information before placing orders and should verify that such information is current and complete. All semiconductor products (also referred to herein as "components") are sold subject to TI's terms and conditions of sale supplied at the time of order acknowledgment.

TI warrants performance of its components to the specifications applicable at the time of sale, in accordance with the warranty in TI's terms and conditions of sale of semiconductor products. Testing and other quality control techniques are used to the extent TI deems necessary to support this warranty. Except where mandated by applicable law, testing of all parameters of each component is not necessarily performed.

TI assumes no liability for applications assistance or the design of Buyers' products. Buyers are responsible for their products and applications using TI components. To minimize the risks associated with Buyers' products and applications, Buyers should provide adequate design and operating safeguards.

TI does not warrant or represent that any license, either express or implied, is granted under any patent right, copyright, mask work right, or other intellectual property right relating to any combination, machine, or process in which TI components or services are used. Information published by TI regarding third-party products or services does not constitute a license to use such products or services or a warranty or endorsement thereof. Use of such information may require a license from a third party under the patents or other intellectual property of the third party, or a license from TI under the patents or other intellectual property of TI.

Reproduction of significant portions of TI information in TI data books or data sheets is permissible only if reproduction is without alteration and is accompanied by all associated warranties, conditions, limitations, and notices. TI is not responsible or liable for such altered documentation. Information of third parties may be subject to additional restrictions.

Resale of TI components or services with statements different from or beyond the parameters stated by TI for that component or service voids all express and any implied warranties for the associated TI component or service and is an unfair and deceptive business practice. TI is not responsible or liable for any such statements.

Buyer acknowledges and agrees that it is solely responsible for compliance with all legal, regulatory and safety-related requirements concerning its products, and any use of TI components in its applications, notwithstanding any applications-related information or support that may be provided by TI. Buyer represents and agrees that it has all the necessary expertise to create and implement safeguards which anticipate dangerous consequences of failures, monitor failures and their consequences, lessen the likelihood of failures that might cause harm and take appropriate remedial actions. Buyer will fully indemnify TI and its representatives against any damages arising out of the use of any TI components in safety-critical applications.

In some cases, TI components may be promoted specifically to facilitate safety-related applications. With such components, TI's goal is to help enable customers to design and create their own end-product solutions that meet applicable functional safety standards and requirements. Nonetheless, such components are subject to these terms.

No TI components are authorized for use in FDA Class III (or similar life-critical medical equipment) unless authorized officers of the parties have executed a special agreement specifically governing such use.

Only those TI components which TI has specifically designated as military grade or "enhanced plastic" are designed and intended for use in military/aerospace applications or environments. Buyer acknowledges and agrees that any military or aerospace use of TI components which have **not** been so designated is solely at the Buyer's risk, and that Buyer is solely responsible for compliance with all legal and regulatory requirements in connection with such use.

TI has specifically designated certain components as meeting ISO/TS16949 requirements, mainly for automotive use. In any case of use of non-designated products, TI will not be responsible for any failure to meet ISO/TS16949.

Products

Audio	www.ti.com/audio
Amplifiers	amplifier.ti.com
Data Converters	dataconverter.ti.com
DLP® Products	www.dlp.com
DSP	dsp.ti.com
Clocks and Timers	www.ti.com/clocks
Interface	interface.ti.com
Logic	logic.ti.com
Power Mgmt	power.ti.com
Microcontrollers	microcontroller.ti.com
RFID	www.ti-rfid.com
OMAP Applications Processors	www.ti.com/omap
Wireless Connectivity	www.ti.com/wirelessconnectivity

Applications

Automotive and Transportation	www.ti.com/automotive
Communications and Telecom	www.ti.com/communications
Computers and Peripherals	www.ti.com/computers
Consumer Electronics	www.ti.com/consumer-apps
Energy and Lighting	www.ti.com/energy
Industrial	www.ti.com/industrial
Medical	www.ti.com/medical
Security	www.ti.com/security
Space, Avionics and Defense	www.ti.com/space-avionics-defense
Video and Imaging	www.ti.com/video

TI E2E Community

e2e.ti.com