

PLEASE CHECK WWW.MOLEX.COM FOR LATEST PART INFORMATION

Part Number: [0039012046](#)
Status: **Active**
Overview: [Mini-Fit Jr.™ Power Connectors](#)
Description: [Mini-Fit Jr.™ Plug Housing, Dual Row, 4 Circuits, UL 94V-0, Natural](#)

Documents:

| | |
|--|---|
| 3D Model | Product Specification PS-5556-001 (PDF) |
| Drawing (PDF) | Packaging Specification PK-5559-001 (PDF) |
| Product Specification PS-45750-001 (PDF) | RoHS Certificate of Compliance (PDF) |

Agency Certification

| | |
|-----|---------|
| CSA | LR19980 |
| UL | E29179 |

General

| | |
|----------------|--|
| Product Family | Crimp Housings |
| Series | 5559 |
| Application | Power, Wire-to-Board, Wire-to-Wire |
| Comments | Current = 13A max. per circuit when header is mated to a receptacle loaded with 45750 series terminals crimped to 16 AWG wire. . See Molex product specification PS-45750-001 for additional current derating information.. Glow Wire Equivalent Part. |
| Overview | Mini-Fit Jr.™ Power Connectors |
| Product Name | Mini-Fit Jr.™ |
| UPC | 800753618022 |

Physical

| | |
|-------------------------------|-----------------|
| Breakaway | No |
| Circuits (maximum) | 4 |
| Color - Resin | Natural |
| Flammability | 94V-0 |
| Gender | Plug |
| Glow-Wire Compliant | No |
| Material - Resin | Nylon |
| Net Weight | 1759.300/mg |
| Number of Rows | 2 |
| Packaging Type | Bag |
| Panel Mount | Yes |
| Pitch - Mating Interface | 4.20mm |
| Pitch - Termination Interface | 4.20mm |
| Polarized to Mating Part | Yes |
| Stackable | No |
| Temperature Range - Operating | -40°C to +105°C |

Electrical

| | |
|-------------------------------|-------|
| Current - Maximum per Contact | 13.0A |
|-------------------------------|-------|

Solder Process Data

| | |
|-----------------------------|-----|
| Lead-freeProcess Capability | N/A |
|-----------------------------|-----|

Material Info

| | |
|-----------------|--------------|
| Old Part Number | 5559-04P-210 |
|-----------------|--------------|

Reference - Drawing Numbers

| | |
|-------------------------|---------------------------|
| Packaging Specification | PK-5559-001 |
| Product Specification | PS-45750-001, PS-5556-001 |
| Sales Drawing | SD-5559-NP |

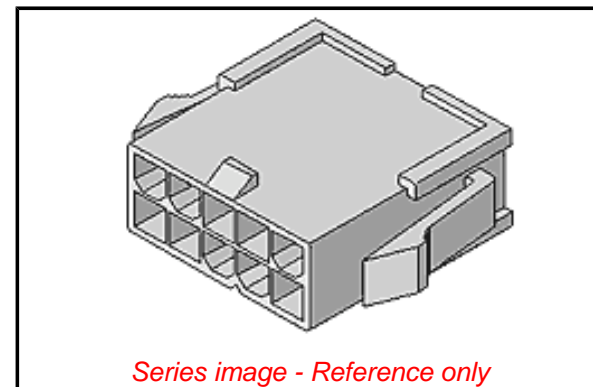

EU ELV

Not Relevant

EU RoHS

Compliant

REACH SVHC

Contains SVHC(2015 June 15): No

Halogen-Free

Status

Low-Halogen

Need more information on product environmental compliance?

Email productcompliance@molex.com
Please visit the [Contact Us](#) section for any non-product compliance questions.

China ROHS

ELV

Green Image

Not Relevant

Search Parts in this Series

[5559](#) Series

Mates With

[5557](#) Dual Row Receptacle Housing

Use With

[5558](#) , [30490](#) Male Terminal

This document was generated on 08/26/2015

PLEASE CHECK WWW.MOLEX.COM FOR LATEST PART INFORMATION