

Safety isolating transformer

AVB 2,3/2/9



Picture shows AVB 3,2/2/18

Advantages

- Minimum size at high output
- Unconditionally short-circuit proof
- Double input voltage for series or parallel connection
- Also with double output voltage for series or parallel connection
- Designed for high ambient temperatures
- Permanent corrosion protection, high insulation value and maximum electrical reliability thanks to XtraDenseFill resin encapsulation
- Coil shell in 2-chamber technology
- Self-extinguishing potting and hood material

Applications

As a mains transformer for adjustment of the voltage and simple electrical isolation.

As a safety transformer for the safe electrical isolation of the input and output sides. The transformer is suitable for creating SELV and PELV circuits because of the limit on the output voltage.

Sample application

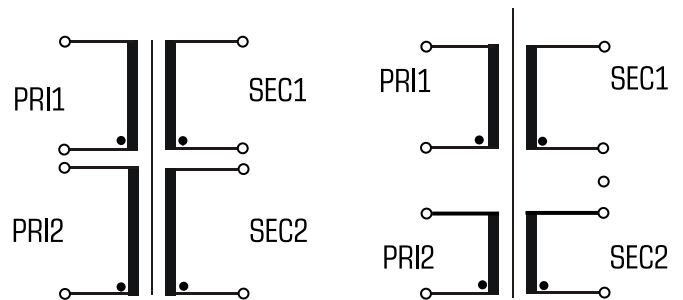

Standards



Safety isolating transformer
to: VDE 0570 Part 2-6, DIN EN 61558-2-6, EN 61558-2-6, IEC 61558-2-6,
UL 5085-1/-2, CSA 22.2 No.66

Approvals



UL 5085-1/-2, CSA 22.2 No.66



Safety isolating transformer

AVB 2,3/2/9

Electrical data	
Type	AVB 2,3/2/9
Input	
Rated input voltage	2 x 115 Vac
Rated frequency	50 - 60 Hz
Output	
Rated output voltage	2 x 9 Vac
Rated Power	2.30 VA
No-load voltage (app. x factor)	1.43
No-load loss (typ.)	0.90 W
Efficiency	59 %
Standards	
Classification	Safety isolating transformer
Approvals	
Approvals	cURus
Environment	
Ambient temperature max.	70 °C
Safety and protection	
Type	Encapsulated
Class of Insulation System	VDE=B, UL=class 105
Protection index	IP 00
Safety class (prepared)	II
Short circuit strength	inherently short-circuit proof
Order numbers	
Order Number	AVB 2,3/2/9

Mechanical data	
Type	AVB 2,3/2/9
Terminal and mounting	
Terminals	Pins for printed circuit boards
Pin (ø)	0.8
Measures and weights	
Core type	EI 30/18
Weight	0.11 kg

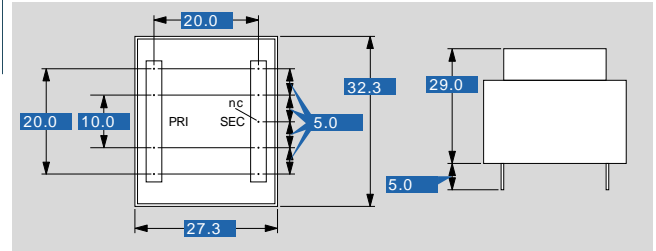

Subjects to change.