



Features

- Superior circuit protection
- Overcurrent & overvoltage protection
- Blocks surges up to rated limits
- High-speed performance
- Small SMT package
- RoHS compliant*
- Agency recognition: ®



The Model TBU-PK Series is obsolete and not recommended for new designs. The **Model TBU-PL Series** is the recommended alternative.

TBU-PK Series - TBU® High-Speed Protectors

General Information

The TBU-PK Series of Bourns® TBU® products are low capacitance dual bidirectional high-speed protection components, constructed using MOSFET semiconductor technology, and designed to protect against faults caused by short circuits, AC power cross, induction and lightning surges.

In addition to overcurrent protection, an added feature is the voltage monitoring on the two lines. If the voltage on the line drops below V_{SS} then the voltage will trigger the device to switch to the blocking state.

The TBU® high-speed protector placed in the system circuit will monitor the current with the MOSFET detection circuit triggering to provide an effective barrier behind which sensitive electronics will not be exposed to large voltages or currents during surge events. The TBU® device is provided in a surface mount DFN package and meets industry standard requirements such as RoHS and Pb Free solder reflow profiles.

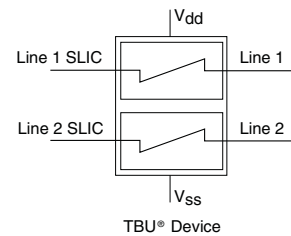

Agency Approval

Description	
UL	File Number: E315805

Industry Standards (in Conjunction with OVP Device)

Solutions available for GR-1089-CORE, ITU-T and a combination of both.

Absolute Maximum Ratings (@ $T_A = 25^\circ\text{C}$ Unless Otherwise Noted)

Symbol	Parameter	Part Number	Value	Unit
V_{imp}	Peak impulse voltage withstand with duration less than 10 ms	TBU-PK050-100-WH	500	V
		TBU-PK060-100-WH	600	
		TBU-PK075-100-WH	750	
		TBU-PK085-100-WH	850	
V_{rms}	Continuous A.C. RMS voltage	TBU-PK050-100-WH	300	V
		TBU-PK060-100-WH	350	
		TBU-PK075-100-WH	400	
		TBU-PK085-100-WH	425	
T_{op}	Operating temperature range		-55 to +125	$^\circ\text{C}$
T_{stg}	Storage temperature range		-65 to +150	$^\circ\text{C}$
T_{jmax}	Maximum junction temperature		+125	$^\circ\text{C}$
ESD	HBM ESD protection per IEC 61000-4-2 on line pads		± 2	kV

Electrical Characteristics (@ $T_A = 25^\circ\text{C}$ Unless Otherwise Noted)

Symbol	Parameter	Min.	Typ.	Max.	Unit	
$I_{trigger}$	Current required for the device to go from operating state to protected state	100	150	200	mA	
R_{device}	Series resistance of the TBU® device	65	80	90	Ω	
R_{match}	Package resistance matching of the TBU® device #1 - TBU® device #2		± 0.5	± 1.6	Ω	
t_{block}	Time taken for the device to go into current limiting			1	μs	
I_Q	Current through the triggered TBU® device with 50 Vdc circuit voltage	0.25	0.70	1.50	mA	
I_{SS}	Operating current with $V_{SS} = -50\text{ V}$		100		μA	
V_{reset}	Voltage below which the triggered TBU® device will transition to normal operating state	Forward Mode	12	15	22	V
		Reverse Mode	10	13	20	
V_{to}	Voltage threshold offset with 60 Hz applied voltage, with $V_{SS} -50\text{ V}$ ($V_{SS} - V_{lineSLIC}$)	-1.0		0.2	V	
V_{SS}	Operating voltage range relative to V_{DD}	-180		-20	V	
$R_{th(j-l)}$	One side junction to package pads - FR4 using minimum recommended pad layout		110		$^\circ\text{C}/\text{W}$	
$R_{th(j-l)}$	Both sides junction to package pads - FR4 using minimum recommended pad layout		65		$^\circ\text{C}/\text{W}$	
$R_{th(j-l)}$	One side junction to package pads - FR4 using heat sink on board (6 cm ²) (0.5 in. ²)		70		$^\circ\text{C}/\text{W}$	
$R_{th(j-l)}$	Both sides junction to package pads - FR4 using heat sink on board (6 cm ²) (0.5 in. ²)		40		$^\circ\text{C}/\text{W}$	

*RoHS Directive 2002/95/EC Jan. 27, 2003 including annex and RoHS Recast 2011/65/EU June 8, 2011. Specifications are subject to change without notice.

The device characteristics and parameters in this data sheet can and do vary in different applications and actual device performance may vary over time. Users should verify actual device performance in their specific applications.

Applications

- SLIC protection
- Cable & DSL
- MDU/MTU modems
- ONT
- Voice/DSL line cards

TBU-PK Series - TBU® High-Speed Protectors

BOURNS®

Functional Block Diagram

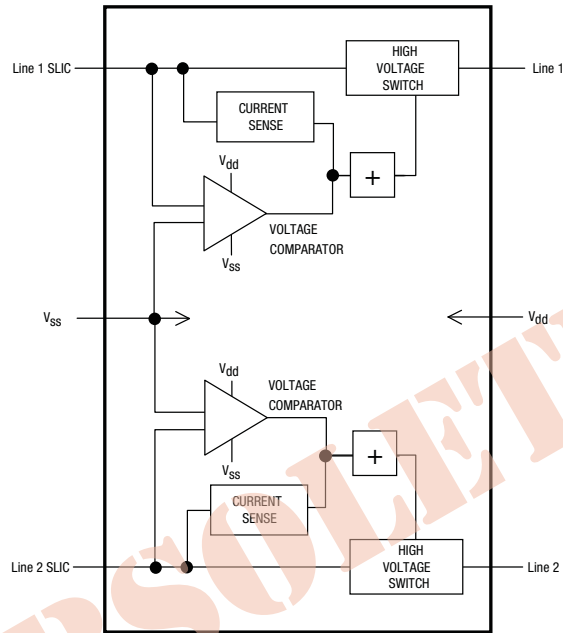

Reference Application

The TBU-PK Series are high-speed protectors used in voice/VoIP SLIC applications. The maximum voltage rating of the TBU® device should never be exceeded. Where necessary, an OVP device should be employed to limit the maximum voltage. A cost-effective protection solution combines Bourns® TBU® protection devices with a pair of Bourns® MOVs. For bandwidth sensitive applications, a Bourns® GDT may be substituted for the MOV. If EN55024 EMC compliance is required, the TBU® device may require capacitors to be fitted between the Tip and Ring connections and ground.

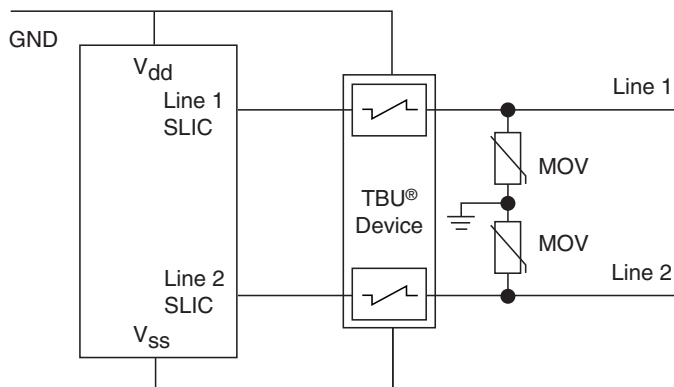

Basic TBU Operation

The TBU® device, constructed using MOSFET semiconductor technology, placed in the system circuit will monitor the current with the MOSFET detection circuit triggering to provide an effective barrier behind which sensitive electronics are not exposed to large voltages or currents during surge events. The TBU® device operates in approximately 1 μ s - once line current exceeds the TBU® device's trigger current $I_{trigger}$. When operated, the TBU® device restricts line current to less than 1 mA typically. When operated, the TBU® device will block all system voltages and any other voltages including the surge in each case up to rated limits.

When the voltage on the SLIC output is driven below ($V_{bat} - V_{to}$) the TBU-PK series device switches to the blocking state, regardless of output current in the device.

After the surge, the TBU® device resets when the voltage across the TBU® device falls to the V_{reset} level. The TBU® device will automatically reset on lines which have no DC bias or have DC bias below V_{reset} (such as unpowered signal lines).

If the line has a normal DC bias above V_{reset} , the voltage across the TBU® device may not fall below V_{reset} after the surge. In such cases, special care needs to be taken to ensure that the TBU® device will reset, with software monitoring as one method used to accomplish this. Bourns application engineers can provide further assistance.

TBU-PK Series - TBU® High-Speed Protectors

BOURNS®

Bourns® TBU® Device Solutions

Industry Standard	Surge & AC Withstand	TBU® Device P/N	Qty.	OVP Device P/N	Qty.
Telcordia GR-1089-CORE Intra-building Port Type 4	1500 V, 100 A 2/10 μ s 120 V _{rms} , 25 A, 900 s	TBU-PK050-100-WH	1	MOV-07D201K	2
Telcordia GR-1089-CORE Intra-building Port Type 4a	1000 V, 100 A 10/1000 μ s 120 V _{rms} , 25 A, 900 s	TBU-PK060-100-WH	1	MOV-10D201K	2
Non-GR-1089-CORE Intra-building Specifications	5000 V, 500 A 2/10 μ s 230 V _{rms} , 25 A, 900 s	TBU-PK085-100-WH	1	MOV-10D361K	2
	1500 V, 100 A 2/10 μ s 275 V _{rms} , 25 A, 900 s	TBU-PK085-100-WH	1	MOV-10D431K	2
ITU-T Basic K.20, K.21, K.45	4000 V, 40 Ω 10/700 μ s 230 V _{rms} 10 Ω - 1000 Ω , 900 s 600 V _{rms} 600 Ω , 0.2 s	TBU-PK075-100-WH	1	MOV-10D361K	2
	4000 V, 40 Ω 10/700 μ s 230 V _{rms} 10 Ω - 1000 Ω , 900 s 600 V _{rms} 600 Ω , 0.1 s	TBU-PK060-100-WH	1	TISP4400M3BJ	2
ITU-T Enhanced K.20, K.21, K.45	6000 V, 40 Ω 10/700 μ s 240 V _{rms} 10 Ω - 1000 Ω , 900 s 600 V _{rms} 600 Ω , 0.2 s 600 V _{rms} 600 Ω , 1 s* 1500 V _{rms} , 200 Ω , 2 s*	TBU-PK085-100-WH	1	MOV-10D391K	2
	6000 V, 40 Ω 10/700 μ s 240 V _{rms} 10 Ω - 1000 Ω , 900 s 600 V _{rms} 600 Ω , 1 s 1500 V _{rms} , 200 Ω , 2 s	TBU-PK060-100-WH	1	TISP4500H3BJ	2

* GDT Special Test Protector with DC breakdown (DCBD) of less than 330 V.

Notes:

- 1) The Le9500, Le9520 and Le9530 (VE950 series) require a 200 mA I_{trigger} TBU® device for normal operation. Other SLIC types should use the 100 mA device.
- 2) The MOV maximum continuous rms voltage rating should not be exceeded. The exception is where the data sheet highlights withstand capability such as the 600 V_{rms}, 1 A for 0.2 s, for example.
- 3) If EN55024 EMC compliance is required, the TBU® device may require capacitors to be fitted between the Tip and Ring connections and ground (i.e. in parallel with the MOV device). The capacitance value can be chosen to meet levels as follows:
 - 10 nF for EN55024 Level 1
 - 20 nF for EN55024 Level 2
 - 47 nF for EN55024 Level 3

Selection of capacitor voltage rating depends upon TBU® part number selection. Recommendations include:

- TBU-PK050 & TBU-PK060 Series: 120 VAC, 500 V Peak Surge Rated
- TBU-PK075 & TBU-PK085 Series: 240 VAC, 750 V Peak Surge Rated

Depending upon the SLIC type, it is usually possible to remove any EMI capacitors present between the output of the SLIC and ground when using capacitors C1 and C2 in parallel with the MOVs.

Specifications are subject to change without notice.

The device characteristics and parameters in this data sheet can and do vary in different applications and actual device performance may vary over time. Users should verify actual device performance in their specific applications.

TBU-PK Series - TBU[®] High-Speed Protectors

BOURNS[®]

Performance Graphs

Typical V-I Characteristics (TBU-PK085-100-WH)

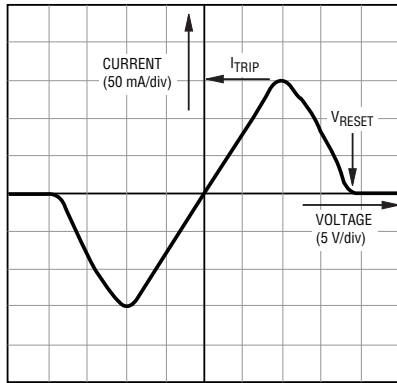

Typical Trigger Current vs. Temperature

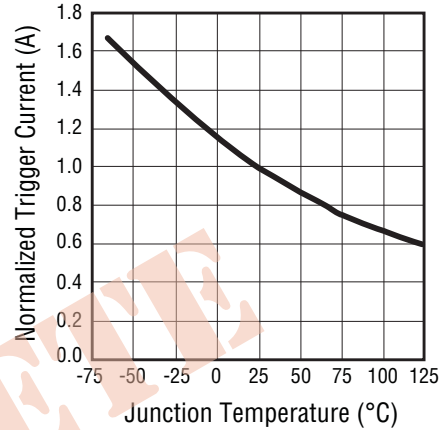

Tracking Voltage Characteristics

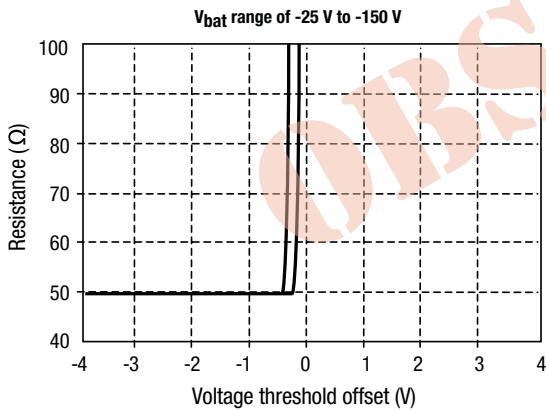

Typical Resistance vs. Temperature

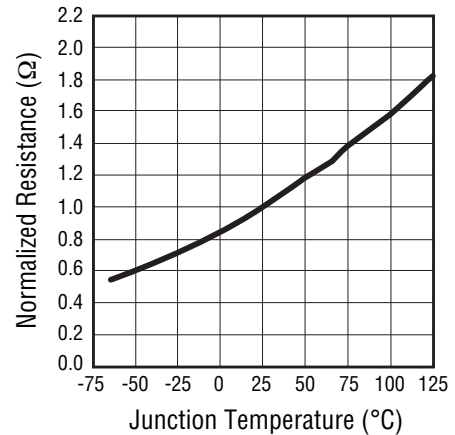

Power Derating Curve

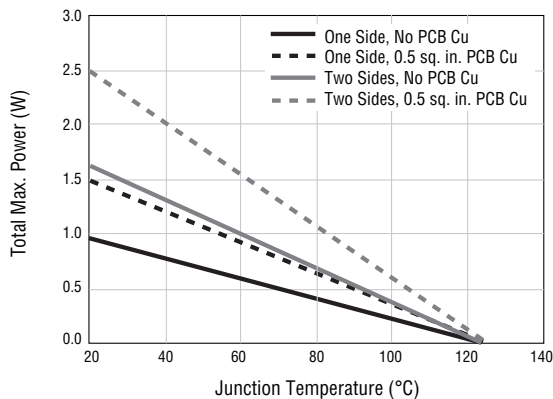

Typical Surge Response

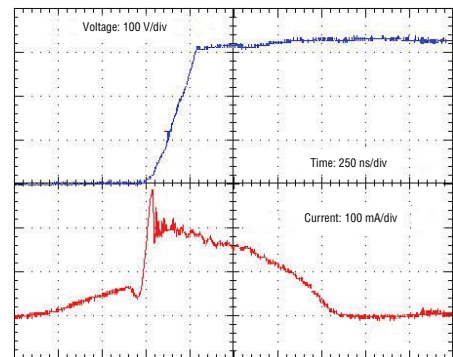

(TBU-PK050-100-WH with MOV-07D201K
Using 1800 V 1.2/50 ms Surge Pulse)

Specifications are subject to change without notice.
The device characteristics and parameters in this data sheet can and do vary in different applications and actual device performance may vary over time.
Users should verify actual device performance in their specific applications.

TBU-PK Series - TBU® High-Speed Protectors

BOURNS®

Product Dimensions

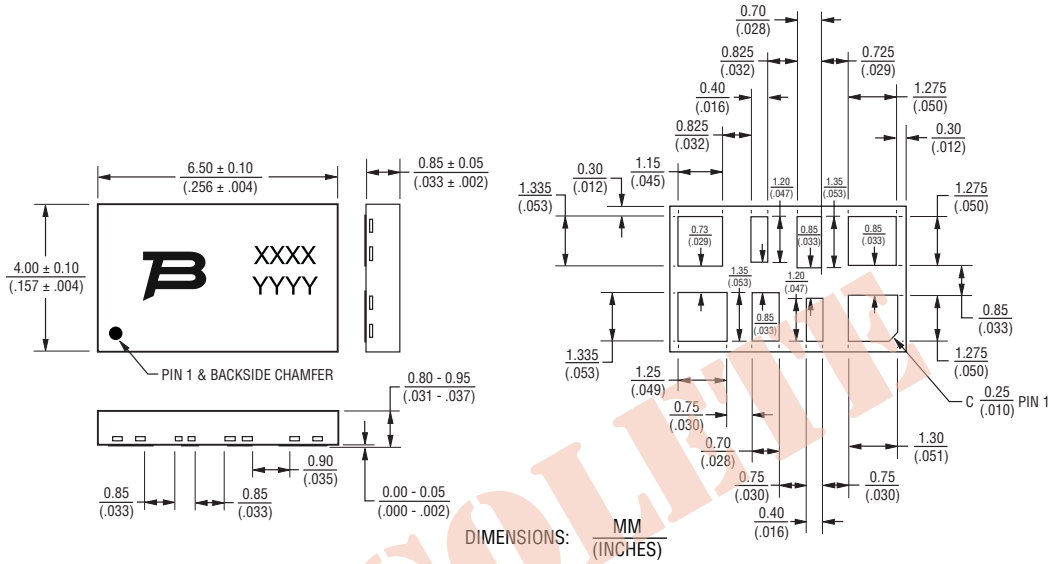

Recommended Pad Layout

TBU® High-Speed Protectors have a 100 % matte-tin termination finish. For improved thermal dissipation, the recommended layout uses PCB copper areas that extend beyond the exposed solder pad. The exposed solder pads should be defined by a solder mask which matches the pad layout of the TBU® device in size and spacing. It is recommended that they should be the same dimension as the TBU® pads but if smaller solder pads are used, they should be centered on the TBU® package terminal pads and not more than 0.10-0.12 mm (0.004-0.005 in.) smaller in overall width or length. Solder pad areas should not be larger than the TBU® pad sizes to ensure adequate clearance is maintained. The recommended

stencil thickness is 0.10-0.12 mm (0.004-0.005 in.) with a stencil opening size 0.025 mm (0.0010 in.) less than the solder pad size. Extended copper areas beyond the solder pad significantly improve the junction to ambient thermal resistance, resulting in operation at lower junction temperatures with a corresponding benefit of reliability. All pads should be soldered to the PCB, including pads marked as NC or NU but no electrical connection should be made to these pads. For minimum parasitic capacitance, it is recommended that signal, ground or power signals are not routed beneath any pad.

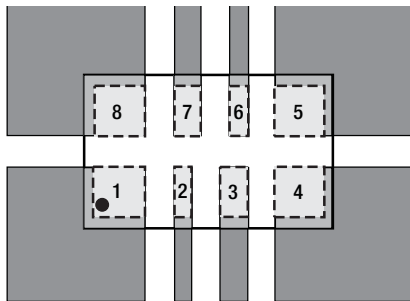

Dark grey areas show added PCB copper area for better thermal resistance.

Thermal Resistance vs Additional PCB Cu Area

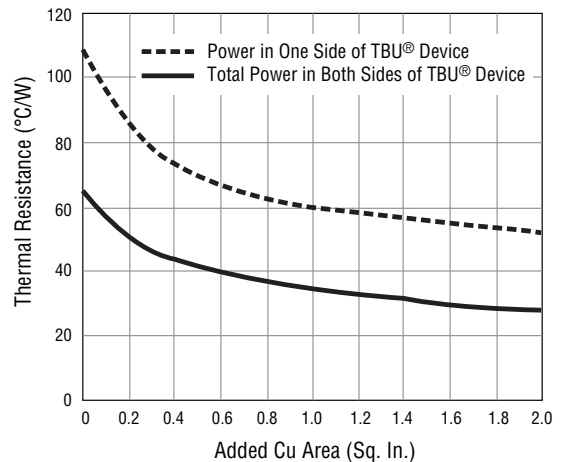

Specifications are subject to change without notice. The device characteristics and parameters in this data sheet can and do vary in different applications and actual device performance may vary over time. Users should verify actual device performance in their specific applications.

TBU-PK Series - TBU® High-Speed Protectors



Reflow Profile

Profile Feature	Pb-Free Assembly
Average Ramp-Up Rate (T _{smax} to T _p)	3 °C/sec. max.
Preheat <ul style="list-style-type: none"> - Temperature Min. (T_{smin}) - Temperature Max. (T_{smax}) - Time (t_{smin} to t_{smax}) 	150 °C 200 °C 60-180 sec.
Time maintained above: <ul style="list-style-type: none"> - Temperature (T_L) - Time (t_L) 	217 °C 60-150 sec.
Peak/Classification Temperature (T _p)	260 °C
Time within 5 °C of Actual Peak Temp. (t _p)	20-40 sec.
Ramp-Down Rate	6 °C/sec. max.
Time 25 °C to Peak Temperature	8 min. max.

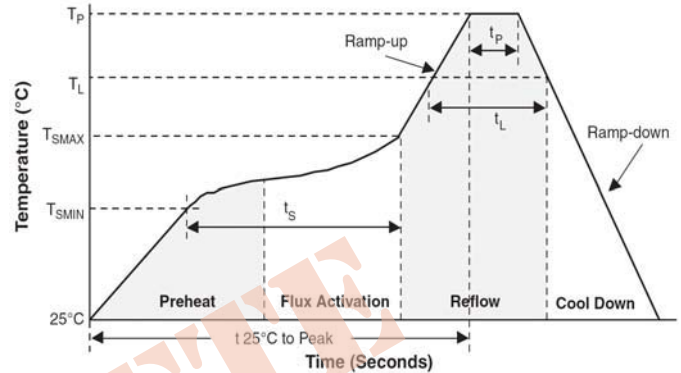

How to Order

TBU - PK 085 - 100 - WH

TBU® Product _____
 Series _____
 PK = Dual Bidirectional Series
 Impulse Voltage Rating _____
 050 = 500 V
 060 = 600 V
 075 = 750 V
 085 = 850 V
 Trigger Current _____
 100 = 100 mA
 Hold to Trip Ratio Suffix _____
 W = Hold to Trip Ratio
 Package Suffix _____
 H = DFN Package

Typical Part Marking

MANUFACTURER'S TRADEMARK: **B**

PRODUCT CODE: **XXXX YYYY**

- 1ST DIGIT INDICATES PRODUCT FAMILY: K = TBU-PK SERIES
- 2ND & 3RD DIGITS INDICATE IMPULSE VOLTAGE: 50 = 500 V 60 = 600 V 75 = 750 V 85 = 850 V
- 4TH DIGIT INDICATES TRIGGER CURRENT: 1 = 100 mA

PIN 1

MANUFACTURING DATE CODE: **XXXX YYYY**

- 1ST DIGIT INDICATES THE YEAR'S 6-MONTH PERIOD.
- 2ND DIGIT INDICATES THE WEEK NUMBER IN THE 6-MONTH PERIOD.
- 3RD & 4TH DIGITS INDICATE SPECIFIC LOT FOR THE WEEK.

6-MONTH PERIOD CODES:
 A = JAN-JUN 2009 C = JAN-JUN 2010 E = JAN-JUN 2011
 B = JUL-DEC 2009 D = JUL-DEC 2010 F = JUL-DEC 2011

Device Pin Out

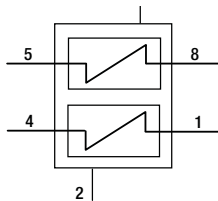

Pad Designation

Pad #	Pin Out
1	Line 1
2	V _{dd} (SLIC Ground or 0 V)
3	Not Used
4	Line 1 SLIC
5	Line 2 SLIC
6	V _{SS} (SLIC Negative Supply or -V _{bat})
7	Not Used
8	Line 2

TBU-PK Series - TBU® High-Speed Protectors

BOURNS®

Packaging Specifications

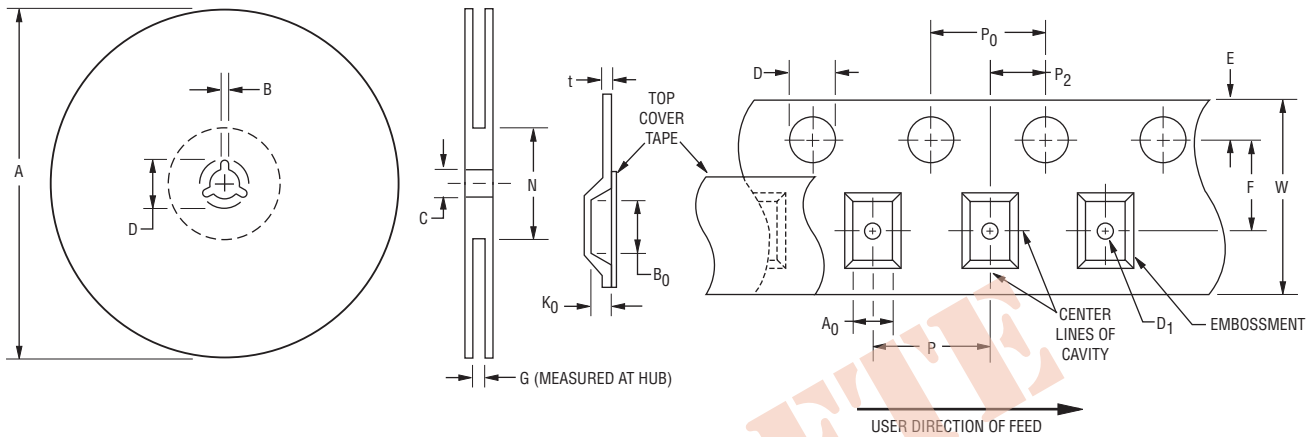

QUANTITY: 3000 PIECES PER REEL

A		B		C		D		G	N
Min.	Max.	Min.	Max.	Min.	Max.	Min.	Max.	Ref.	Ref.
<u>326</u>	<u>330</u>	<u>1.5</u>	<u>2.5</u>	<u>12.8</u>	<u>13.5</u>	<u>20.2</u>	-	<u>16.5</u>	<u>102</u>
(12.835)	(13.002)	(.059)	(.098)	(.504)	(.531)	(.795)		(.650)	(4.016)

A ₀		B ₀		D		D ₁		E		F	
Min.	Max.	Min.	Max.	Min.	Max.	Min.	Max.	Min.	Max.	Min.	max.
<u>4.30</u>	<u>4.50</u>	<u>6.70</u>	<u>6.90</u>	<u>1.5</u>	<u>1.6</u>	<u>1.5</u>	-	<u>1.65</u>	<u>1.85</u>	<u>7.4</u>	<u>7.6</u>
(.169)	(.177)	(.264)	(.272)	(.059)	(.063)	(.059)		(.065)	(.073)	(.291)	(.299)
K ₀		P		P ₀		P ₂		t		W	
Min.	Max.	Min.	Max.	Min.	Max.	Min.	Max.	Min.	Max.	Min.	Max.
<u>1.0</u>	<u>1.2</u>	<u>7.9</u>	<u>8.1</u>	<u>3.9</u>	<u>4.1</u>	<u>1.9</u>	<u>2.1</u>	<u>0.25</u>	<u>0.35</u>	<u>15.7</u>	<u>16.3</u>
(.039)	(.047)	(.311)	(.319)	(.159)	(.161)	(.075)	(.083)	(.010)	(.014)	(.618)	(.642)

DIMENSIONS: $\frac{\text{MM}}{\text{(INCHES)}}$

BOURNS®

Asia-Pacific: Tel: +886-2 2562-4117 • Fax: +886-2 2562-4116

EMEA: Tel: +36 88 520 390 • Fax: +36 88 520 211

The Americas: Tel: +1-951 781-5500 • Fax: +1-951 781-5700

www.bourns.com

REV. 04/15

"TBU" is a registered trademark of Bourns, Inc. in the United States and other countries.

Specifications are subject to change without notice.

The device characteristics and parameters in this data sheet can and do vary in different applications and actual device performance may vary over time. Users should verify actual device performance in their specific applications.