

ZS4-SF-T Screw Clamp Terminal Blocks For 5 x 20 fuses - with test socket

- Protect your circuits with 5x20 Fuse terminal blocks compliant with IEC 60947-7-3 standard (fuse not supplied with the terminal blocks),
- Simplify the distribution thanks to the two jumper channels aligned with ZS4 feed-through and ZS4-S-R1 disconnect terminal blocks,
- Ease the test with built-in test sockets.

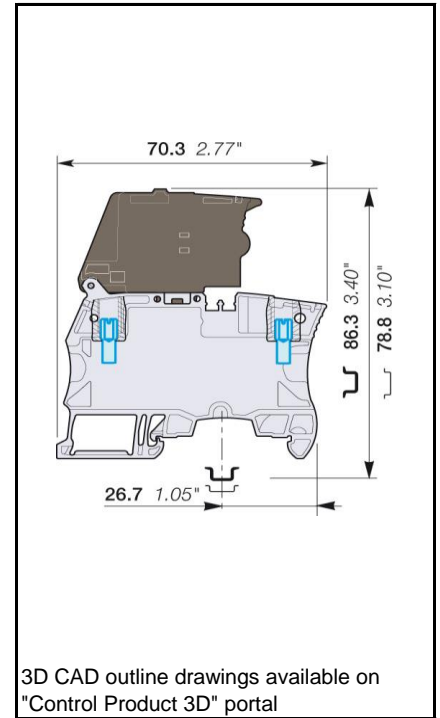

		4 mm ²
		10 AWG
6 mm 0.236 in Spacing		

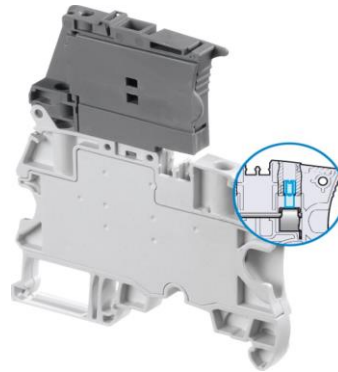







Ordering Details

Color	Type	Order Code	EAN Code	Pack ^(ing)	Weight (1 pce) g
Grey, Dark Grey	ZS4-SF-T2	1SNK506411R0000	3472595064113	50	18.60

Declarations and Certificates



CE	CB	RoHS	US	USR CNR		Gost R			
		BV	Fina	DNV					

Declarations and Certificates

	CE	1SND225098C10*
	CB	1SND161029A02*
	RoHS	1SND230491F02*
	USR CNR	1SND161040A02*
	CSA	1SND161070A02*
	GOST R	1SND161005A11*
	BV	1SND161073A02*
	RINA	1SND161088A02*
	DNV	1SND161087A02*

General Information

The following information must be strictly adhered to in order to guarantee the terminal block electrical, mechanical and environmental performance.

Protection	IEC 60947-1	IP20		NEMA 1			
Rail	TH35-7.5, TH35-15	TH35-7.5, TH35-15					
Wire stripping length		10.5 mm	0.413 in				
		Screw clamp		Screw rail contact (Maximum value)		Disconnect device	
Operating tool		Flat screwdriver					
		3.5 mm	0.138 in				
Torque		0.6 N.m	5.31 lb.in				
		± 0.1 N.m	± 0.885 lb.in				

Material Specifications

Insulating material	Polyamide
CTI	600 V
Flammability	UL94 V0
	NF F 16101 I2F2
	Needle flame test: C 60615-11-5 Compliant

Connecting capacity per clamp

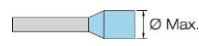
		Screw clamp			
1 Rigid - Solid / Stranded conductor	Norme	IEC60947-7-3	UL1059		
	Value	0.2 ... 4 mm ²	24 ... 10 AWG		
1 Flexible conductor	Norme	IEC60947-7-3			
	Value	0.22 ... 4 mm ²			
1 Flexible conductor with non insulated ferrule	Norme	Manufacturer data	Manufacturer data		
	Value	0.22 ... 4 mm ²	24 ... 12 AWG		
1 Flexible conductor with insulated ferrule	Norme	Manufacturer data	Manufacturer data		
	Value	0.22 ... 4 mm ²	24 ... 12 AWG		
Gauge		A3-B3	3 mm		
		IEC 60947-1	0.118 in		
Ferrule maximum outer diameter or conductor insulation maximum outer diameter		Manufacturer data	5.5 mm		0.216 in

The "Connecting capacity with ferrule" data is guaranteed with ABB crimping tool PS-3 (crimping capacity up to 10 mm²).

As part of its on-going product improvement, ABB reserves the right to modify the characteristics or the products described in this document. The information given is not contractual. For further details please contact the ABB company marketing these products in your country.

Multi Connecting capacity per clamp

2 Rigid - Solid / Stranded conductors	Norme	IEC60947-7-3	UL1059	
	Value	0.2 ... 1.5 mm ²	24 ... 16 AWG	
2 Flexible conductors	Norme	IEC60947-7-3		
	Value	0.2 ... 1.5 mm ²		
2 Flexible conductors with twin ferrule	Norme	Manufacturer data	Manufacturer data	
	Value	0.22 ... 1.5 mm ²	24 ... 16 AWG	

Don't mix **solid and flexible** conductors **in the same clamp**

Don't mix **solid or flexible** conductors of different sizes **in the same clamp**

The "Connecting capacity with ferrule" data is guaranteed with ABB crimping tool PS-3 (crimping capacity up to 10 mm²)

Cross section

Rated cross section	IEC60947-7-3	4 mm ²	UL1059	10 AWG
Maximum Cross section	Manufacturer data	4 mm ²	Manufacturer data	10 AWG

Electrical characteristics

Current

Rated current		IEC60947-7-3	6.3 A
	Field and factory wiring Cat.2	UL 1059	10 A
	Factory wiring Cat.1	UL 1059	10 A
		CSA-C-22.2 n°158	6.3 A
Maximum Exe current		IEC/EN 60079-7	
Rated short-time withstand current 1 s (I _{cw})		IEC60947-7-3	
Short-time withstand current	0.5 s	Manufacturer data	
	5 s	Manufacturer data	
	10 s	Manufacturer data	
	30 s	Manufacturer data	
	1 min	Manufacturer data	
Rated short-circuit withstand current		CSA-C-22.2 n°158	
Max. current (45° temperature increase) / Max. cross section (mm ²)		Manufacturer data	6.3 A 4 mm ²
Maximum short circuit current (1s)		Manufacturer data	

Short Circuit Current Rating (SCCR) SA UL 1059 supplement

SCCR	UL 1059
With the following configurations:	
Suitable conductor wire range	
Maximum voltage	
Fuse class / Max. amp. Rating	J
	T
	RK1
	RK5
	G
	CC

Voltage

Rated voltage	IEC 60947-1	500 V
Rated voltage	UL 1059	150 V
Use Group	UL 1059	A, B, C, D
Rated voltage	CSA-C-22.2 n°158	150 V
Rated voltage Ex e	IEC/ EN 60079-7	
Rated impulse withstand voltage	IEC 60947-1	6000 V
Dielectric test voltage	IEC 60947-1	1890 V
Pollution degree	IEC 60947-1	3
Overvoltage category	IEC 60947-1	III

Temperature range

Ambient temperature min/max	Storage	-55 ... +110 °C	-67 ... +230 °F
	Installing	-5 ... +40 °C	-23 ... +104 °F
	Service	-55 ... +110 °C	-67 ... +230 °F

Current Derating curve for continuous service temperature

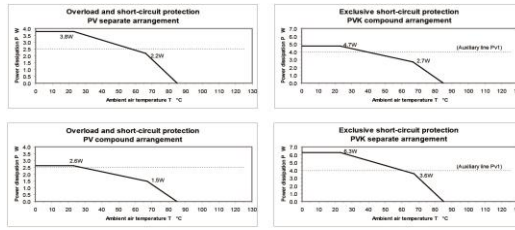

Dissipated power

Maximum dissipated power at rated current	IEC 60947-1
Maximum dissipated power at maximum Exe current	IEC 60079-7

Rated power dissipation at an ambient temperature of 23 °C - IEC 60947-7-3

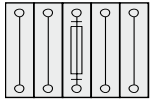
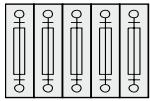
Separate arrangement / Overload and short-circuit protection	 <p>1 fuse and 4 feed-through blocks</p>	2.5
Separate arrangement / Exclusive short-circuit protection		4
Compound arrangement / Overload and short-circuit protection	 <p>5 fuse blocks</p>	2.5
Compound arrangement / Exclusive short-circuit protection		4

Environmental Characteristics Additional climatic tests

Dry heat	Conditions	IEC 60068-2 2	Compliant
		Temperature	+100 °C
		Duration of test	96 h
Cyclic damp heat	Conditions	IEC 60068-2 30	Compliant
		Temperature	+55 °C
		Relative humidity	
		Number of cycles (1 cycle = 24h)	2
Cold	Conditions	IEC 60068-2 1	Compliant
		Temperature	-40 °C
		Duration of test	96 h
Damp heat steady state	Conditions	IEC 60068-2-78	
		Temperature	
		Relative humidity	
		Duration of test	

Corrosion

Salt mist	Conditions	IEC 60068-2 11	Compliant
		Duration of test	96 h
		Concentration	5 %
SO ₂	Conditions	ISO 6988	Compliant
		Duration of test	48 h
		Concentration	0.2 dm ³
Flowing mixed gas corrosion test	Conditions	IEC 60068-2 60	
		Number of the test method	
		Duration of test	

As part of its on-going product improvement, ABB reserves the right to modify the characteristics or the products described in this document. The information given is not contractual. For further details please contact the ABB company marketing these products in your country.

Vibrations and shocks

Sinusoidal vibrations		IEC 60068-2-6	Compliant
	Conditions	Frequency range	10 ... 55 Hz
		Number of cycles	10
		Acceleration	10 m/s ²
Functional random vibrations		IEC 61373	
Category 1 Class B 3 axes	Conditions	Duration of test	
		Frequency range	
		Acceleration	
Long life testing at increased random vibrations		IEC 61373	
Category 1 Class B 3 axes	Conditions	Duration of test	
		Frequency range	
		Acceleration	
Shock		IEC 61373	
Category 1 Class B 3 axes	Conditions	Duration of test	
		Acceleration	

ZS4-SF-T Terminal Block Accessories Compatibility

Some accessories may modify the terminal block's rating. See complete information in the accessories catalog page.

Description	Type	Order Code	Pack ^(ing) pieces	Weight g (1 pce)
1 End Stops	BAM3	1SNK900001R0000	50	13.80
	BAZ1	1SNK900002R0000	20	5.30
2 Jumper Bars	JB6-2	1SNK906302R0000	50	1.30
	JB6-3	1SNK906303R0000	50	2.10
	JB6-4	1SNK906304R0000	50	2.90
	JB6-5	1SNK906305R0000	50	3.60
	JB6-10	1SNK906310R0000	20	7.40
	3 Test Adapters	TP2	1SNK900203R0000	20
TP4		1SNK900205R0000	20	2.41
4 Test Plugs	FC2.MC	1SNA107239R0300	20	1.00
5 Test Connectors	TC5-R1	1SNK900201R0000	10	5.23
6 Spacers	ES-TC6	1SNK900105R0000	10	0.80
7 Mounting Rails	PR3.G2	1SNA164800R0300	2	
	PR4	1SNA168500R1200	2	915.00
	PR5	1SNA168700R2200	2	
	PR30	1SNA173220R0500	2	328.00
	PR3.Z2	1SNA174300R1700	2	
8 Tools	PS-3	1SNK900650R0000	1	380.00
9 Terminal Block Markers	MC612	1SNK150000R0000	22	10.00
	MC612-YL	1SNK150004R0000	22	10.00
	MC612PA	1SNK159999R0000	20	11.00
	UMH	1SNK900611R0000	10	0.20
	PROCAP6	1SNK900612R0000	20	0.78
	SAT6	1SNK900615R0000	5	6.00
10 Screw Clamp Terminal Blocks	ZS4-SF-T2	1SNK506411R0000	50	18.60

As part of its on-going product improvement, ABB reserves the right to modify the characteristics or the products described in this document. The information given is not contractual. For further details please contact the ABB company marketing these products in your country.

Contact us

ABB France
Low Voltage Products Division
Export Department
10, rue Ampère Z.I. - B.P. 114
F-69685 Chassieu cedex / France
Tel. +33 (0)4 7222 1722
Fax +33 (0)4 7222 1935

Note

We reserve the right to make technical changes or modify the contents of this document without prior notice. With regard to purchase orders, the agreed particulars shall prevail. ABB does not accept any responsibility whatsoever for potential errors or possible lack of information in this document.

We reserve all rights in this document and in the subject matter and illustrations contained therein. Any reproduction, disclosure to third parties or utilization of its contents – in whole or in parts – is forbidden without prior written consent of ABB.

Copyright© 2011 ABB
All rights reserved

1SNK161038D0201 - PDF