

ZK2.5-4P PI-Spring Terminal Blocks Feed-through with 4 connections

Find all the features of the ZK2.5 terminal block with the added option of distributing or branching 4 conductors.

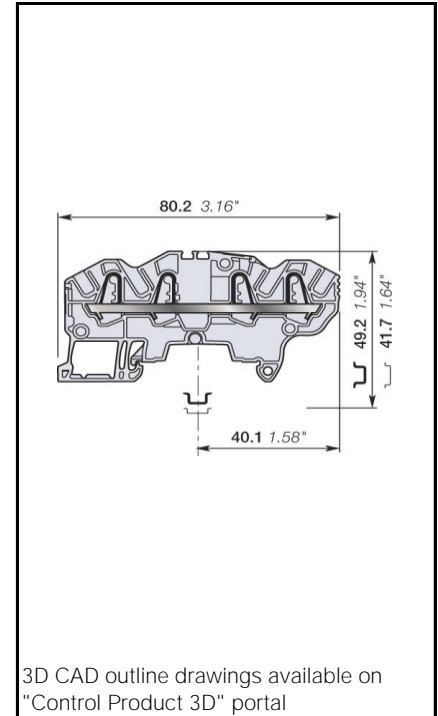
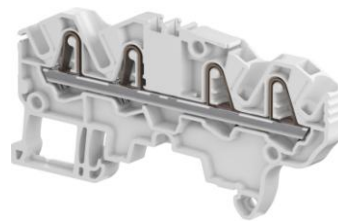

	PI-Spring Terminal Blocks	2.5 mm ²
		12 AWG
5.2 mm 0.205 in Spacing		

Ordering Details

Color	Type	Order Code	EAN Code	Pack ^(ing)	Weight (1 pce)	g
Grey	ZK2.5-4P	1SNK705012R0000	3472597050121	50		9
Blue	ZK2.5-4P-BL	1SNK705022R0000	3472597050220	50		9
Orange	ZK2.5-4P-OR	1SNK705032R0000	3472597050329	50		9
Yellow	ZK2.5-4P-YL	1SNK705074R0000	3472597050749	50		9
Green	ZK2.5-4P-GN	1SNK705075R0000	3472597050756	50		9
Red	ZK2.5-4P-RD	1SNK705076R0000	3472597050763	50		9
Black	ZK2.5-4P-BK	1SNK705080R0000	3472597050800	50		9
White	ZK2.5-4P-WH	1SNK705079R0000	3472597050794	50		9

Declarations and Certificates

CE	CB	RoHS	UL US	UL US	Gost R	ATEX	IECEX
							ATEX Declaration

Declarations and Certificates





	CE	1SND225150C10*
	CB	1SND162016A02*
	RoHs	1SND230535F02*
	USR CNR	1SND162012A02*
	CSA	1SND162014A02*
	GOST R	1SND161005A11*
	ATEX	1SND162009A17*
	IECEX	1SND162010A17*
	BV	1SND162013A02*
Atex Declaration	Atex Declaration	1SND225085C10*

Explosive Atmosphere: ATEX Classification

Group Category	Protection Method
IM2 II 2 GD Ex eb I/IC/IIIC	Ex e: increased security
In the presence of explosive dust atmosphere, terminal blocks are to be installed in certified enclosure II 2D	

General Information

The following information must be strictly adhered to in order to guarantee the terminal block electrical, mechanical and environmental performance.

Protection	IEC 60947-1	IP20	NEMA250					
Rail		TH 35-7.5, TH 35-15						
Wire stripping length		11 mm	0.433 in					
		Screw clamp		Screw rail contact (Maximum value)		Disconnect device		
Operating tool		Flat screwdriver						
Torque		3.5 mm	0.138 in					

Material Specifications

Insulating material	Polyamide
CTI	600 V
Flammability	UL94 V0
	NF F 16101 I2F2
	Needle flame test.C 60615-11-5 Compliant

Connecting capacity per clamp

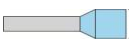
		PI Spring			
1 Rigid - Solid / Stranded conductor	Norme	IEC60947-7-1	UL1059		
	Value	0.2 ... 4 mm ²	26 ... 12 AWG		
1 Flexible conductor	Norme	IEC60947-7-1			
	Value	0.22 ... 2.5 mm ²			
1 Flexible conductor with non insulated ferrule	Norme	Manufacturer data	Manufacturer data		
	Value	0.22 ... 2.5 mm ²	26 ... 14 AWG		
1 Flexible conductor with insulated ferrule	Norme	Manufacturer data	Manufacturer data		
	Value	0.22 ... 2.5 mm ²	26 ... 14 AWG		
Gauge			2.4 mm		
Ferrule maximum outer diameter or conductor insulation maximum outer diameter		IEC 60947-1	Manufacturer data	4.65 mm	

The "Connecting capacity with ferrule" data is guaranteed with ABB crimping tool PS-3 (crimping capacity up to 10 mm²).

As part of its on-going product improvement, ABB reserves the right to modify the characteristics or the products described in this document. The information given is not contractual. For further details please contact the ABB company marketing these products in your country.

Multi Connecting capacity per clamp

2 Rigid - Solid / Stranded conductors	Norme			
	Value			
2 Flexible conductors	Norme			
	Value			
2 Flexible conductors with twin ferrule	Norme	Manufacturer data	Manufacturer data	
	Value	0.22 ... 0.5 mm ²	26 ... 20 AWG	

Don't mix solid and flexible conductors in the same clamp

Don't mix solid or flexible conductors of different sizes in the same clamp

The "Connecting capacity with ferrule" data is guaranteed with ABB crimping tool PS-3 (crimping capacity up to 10 mm²)

Cross section

Rated cross section	IEC60947-7-1	2.5 mm ²	UL1059	12 AWG
Maximum Cross section	Manufacturer data	4 mm ²	Manufacturer data	12 AWG

Electrical characteristics

Current

Rated current		IEC60947-7-1	24 A
	Field and factory wiring Cat.2	UL 1059	20 A
	Factory wiring Cat.1	UL 1059	
		CSA-C-22.2 n°158	20 A
Maximum Exe current		IEC/EN 60079-7	21 A
Rated short-time withstand current 1 s (I _{cw})		IEC60947-7-1	300 A
Short-time withstand current	0.5 s	Manufacturer data	
	5 s	Manufacturer data	
	10 s	Manufacturer data	
	30 s	Manufacturer data	
	1 min	Manufacturer data	
Rated short-circuit withstand current		CSA-C-22.2 n°158	
Max. current (45° temperature increase) / Max. cross section (mm ²)		Manufacturer data	30 A 4 mm ²
Maximum short circuit current (1s)		Manufacturer data	300 A

Short Circuit Current Rating (SCCR) SA UL 1059 supplement

SCCR		UL 1059	100 kA
With the following configurations:			
Suitable conductor wire range			14 ... 12 AWG
Maximum voltage			600 V
Fuse class / Max. amp. Rating		J	110 A
		T	110 A
		RK1	100 A
		RK5	30 A
		G	60 A
		CC	30 A

Voltage

Rated voltage	IEC 60947-1	1000 V
Rated voltage	UL 1059	600 V
Use Group	UL 1059	B, C, D
Rated voltage	CSA-C-22.2 n°158	600 V
Rated voltage Ex e	IEC/ EN 60079-7	630 V
Rated impulse withstand voltage	IEC 60947-1	8000 V
Dielectric test voltage	IEC 60947-1	2200 V
Pollution degree	IEC 60947-1	3
Overvoltage category	IEC 60947-1	III

Temperature range

Ambient temperature min/max	Storage	-55 ... +110 °C	-67 ... +230 °F
	Installing	-5 ... +40 °C	-23 ... +104 °F
	Service	-55 ... +110 °C	-67 ... +230 °F

Current Derating curve for continuous service temperature

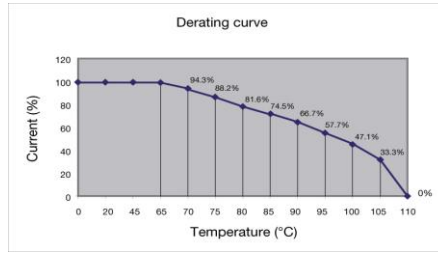

Dissipated power

Maximum dissipated power at rated current	IEC 60947-1	0.8 W
Maximum dissipated power at maximum Exe current	IEC 60079-7	0.7 W

Rated power dissipation at an ambient temperature of 23 °C - IEC 60947-7-3

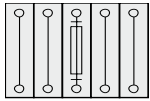
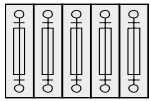
Separate arrangement / Overload and short-circuit protection	 <p>1 fuse and 4 feed-through blocks</p>	
Separate arrangement / Exclusive short-circuit protection		
Compound arrangement / Overload and short-circuit protection	 <p>5 fuse blocks</p>	
Compound arrangement / Exclusive short-circuit protection		

Environmental Characteristics

Additional climatic tests

Dry heat	Conditions	IEC 60068-2 2	Compliant
		Temperature	110 °C
		Duration of test	96 h
Cyclic damp heat	Conditions	IEC 60068-2 30	Compliant
		Temperature	55 °C
		Relative humidity	95 %
		Number of cycles (1 cycle = 24h)	2
Cold	Conditions	IEC 60068-2 1	Compliant
		Temperature	-55 °C
		Duration of test	96 h
Damp heat steady state	Conditions	IEC 60068-2-78	Compliant
		Temperature	40 °C
		Relative humidity	93 %
		Duration of test	96 h

Corrosion

Salt mist	Conditions	IEC 60068-2 11	Compliant
		Duration of test	1000 h
		Concentration	5 %
SO ₂	Conditions	ISO 6988	Compliant
		Duration of test	48 h
		Concentration	0.2 dm ³
Flowing mixed gas corrosion test	Conditions	IEC 60068-2 60	Compliant
		Number of the test method	3
		Duration of test	21 j

As part of its on-going product improvement, ABB reserves the right to modify the characteristics or the products described in this document. The information given is not contractual. For further details please contact the ABB company marketing these products in your country.

Contact us

ABB France
Low Voltage Products Division
Export Department
10, rue Ampère Z.I. - B.P. 114
F-69685 Chassieu cedex / France
Tel. +33 (0)4 7222 1722
Fax +33 (0)4 7222 1935

Note

We reserve the right to make technical changes or modify the contents of this document without prior notice. With regard to purchase orders, the agreed particulars shall prevail. ABB does not accept any responsibility whatsoever for potential errors or possible lack of information in this document.

We reserve all rights in this document and in the subject matter and illustrations contained therein. Any reproduction, disclosure to third parties or utilization of its contents – in whole or in parts – is forbidden without prior written consent of ABB.

Copyright© 2011 ABB
All rights reserved

1SNK162045D0201 - PDF