

ZK2.5-PE-3P PI-Spring Terminal Blocks Ground with 3 connections

Improve the safety of your installation in the event of a short-circuit thanks to our screwless rail contact:

- Rail contact non operator dependent,
- Performances above the requirements of the IEC 60947-7-2 terminal block standard,
- Secured snap on or off the rail,
- Profile aligned with ZK2.5-3P.

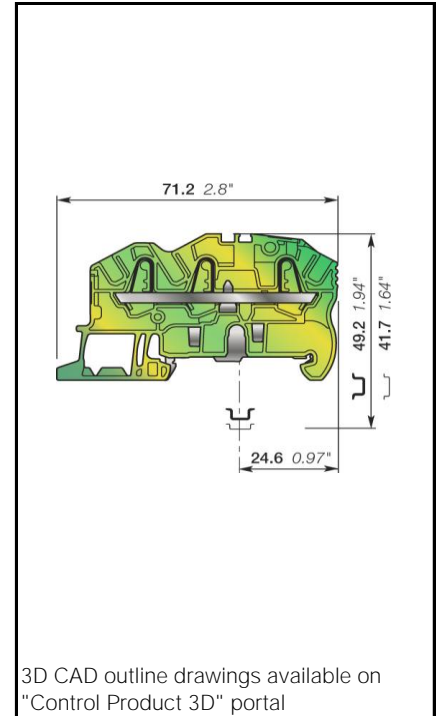
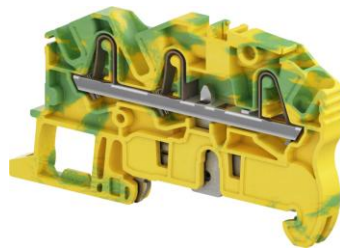

	PI-Spring Terminal Blocks	2.5 mm ²
		12 AWG
5.2 mm 0.205 in Spacing		

Ordering Details

Color	Type	Order Code	EAN Code	Pack ^(ing)	Weight (1 pce) g
Green-yellow	ZK2.5-PE-3P	1SNK705151R0000	3472597051517	20	11.9

Declarations and Certificates

CE	CB	RoHS	US	USR CNR		Gost R	ATEX	IECEX
								ATEX Declaration

Declarations and Certificates





	CE	1SND225151C10*
	CB	1SND162017A02*
	RoHs	1SND230535F02*
	USR CNR	1SND162012A02*
	CSA	1SND162014A02*
	GOST R	1SND161005A11*
	ATEX	1SND162009A17*
	IECEX	1SND162010A17*
	BV	1SND162013A02*
Atex Declaration	Atex Declaration	1SND225085C10*

Explosive Atmosphere: ATEX Classification

Group Category	Protection Method
IM2 II 2 GD Ex eb I/IC/IIIC	Ex e: increased security
In the presence of explosive dust atmosphere, terminal blocks are to be installed in certified enclosure II 2D	

General Information

The following information must be strictly adhered to in order to guarantee the terminal block electrical, mechanical and environmental performance.

Protection	IEC 60947-1	IP20	NEMA250					
Rail		TH 35-7.5, TH 35-15						
Wire stripping length		11 mm	0.433 in					
		Screw clamp		Screw rail contact (Maximum value)		Disconnect device		
Operating tool		Flat screwdriver						
Torque		3.5 mm	0.138 in					

Material Specifications

Insulating material	Polyamide
CTI	600 V
Flammability	UL94 V0
	NF F 16101 I2F2
	Needle flame test.C 60615-11-5 Compliant

Connecting capacity per clamp

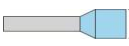
		PI Spring			
1 Rigid - Solid / Stranded conductor	Norme	IEC60947-7-2	UL1059		
	Value	0.2 ... 4 mm ²	26 ... 12 AWG		
1 Flexible conductor	Norme	IEC60947-7-2			
	Value	0.22 ... 2.5 mm ²			
1 Flexible conductor with non insulated ferrule	Norme	Manufacturer data	Manufacturer data		
	Value	0.22 ... 2.5 mm ²	26 ... 14 AWG		
1 Flexible conductor with insulated ferrule	Norme	Manufacturer data	Manufacturer data		
	Value	0.22 ... 2.5 mm ²	26 ... 14 AWG		
Gauge			2.4 mm		
		IEC 60947-1			
Ferrule maximum outer diameter or conductor insulation maximum outer diameter		∅ Max.	Manufacturer data	4.65 mm	

The "Connecting capacity with ferrule" data is guaranteed with ABB crimping tool PS-3 (crimping capacity up to 10 mm²).

As part of its on-going product improvement, ABB reserves the right to modify the characteristics or the products described in this document. The information given is not contractual. For further details please contact the ABB company marketing these products in your country.

Multi Connecting capacity per clamp

2 Rigid - Solid / Stranded conductors	Norme			
	Value			
2 Flexible conductors	Norme			
	Value			
2 Flexible conductors with twin ferrule	Norme			
	Value			

Don't mix solid and flexible conductors in the same clamp

Don't mix solid or flexible conductors of different sizes in the same clamp

The "Connecting capacity with ferrule" data is guaranteed with ABB crimping tool PS-3 (crimping capacity up to 10 mm²)

Cross section

Rated cross section	IEC60947-7-2	2.5 mm ²	UL1059	12 AWG
Maximum Cross section	Manufacturer data	4 mm ²	Manufacturer data	12 AWG

Electrical characteristics

Current

Rated current	IEC60947-7-2	
	Field and factory wiring Cat.2	UL 1059
	Factory wiring Cat.1	UL 1059
	CSA-C-22.2 n°158	
Maximum Exe current	IEC/EN 60079-7	
Rated short-time withstand current 1 s (I _{cw})	IEC60947-7-2	300 A
Short-time withstand current	0.5 s	Manufacturer data
	5 s	Manufacturer data
	10 s	Manufacturer data
	30 s	Manufacturer data
	1 min	Manufacturer data
Rated short-circuit withstand current	CSA-C-22.2 n°158	
Max. current (45° temperature increase) / Max. cross section (mm ²)	Manufacturer data	4 mm ²
Maximum short circuit current (1s)	Manufacturer data	300 A

Short Circuit Current Rating (SCCR) SA UL 1059 supplement

SCCR	UL 1059
With the following configurations:	
Suitable conductor wire range	
Maximum voltage	
Fuse class / Max. amp. Rating	J
	T
	RK1
	RK5
	G
	CC

Voltage

Rated voltage	IEC 60947-1	
Rated voltage	UL 1059	
Use Group	UL 1059	B, C, D
Rated voltage	CSA-C-22.2 n°158	
Rated voltage Ex e	IEC/ EN 60079-7	
Rated impulse withstand voltage	IEC 60947-1	8000 V
Dielectric test voltage	IEC 60947-1	2200 V
Pollution degree	IEC 60947-1	3
Overvoltage category	IEC 60947-1	III

Temperature range

Ambient temperature min/max	Storage	-55 ... +110 °C	-67 ... +230 °F
	Installing	-5 ... +40 °C	-23 ... +104 °F
	Service	-55 ... +110 °C	-67 ... +230 °F

Dissipated power

Maximum dissipated power at rated current	IEC 60947-1
Maximum dissipated power at maximum Exe current	IEC 60079-7

Rated power dissipation at an ambient temperature of 23 °C - IEC 60947-7-3

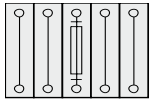
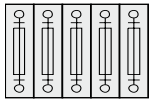
Separate arrangement / Overload and short-circuit protection	 1 fuse and 4 feed-through blocks	
Separate arrangement / Exclusive short-circuit protection		
Compound arrangement / Overload and short-circuit protection	 5 fuse blocks	
Compound arrangement / Exclusive short-circuit protection		

Environmental Characteristics

Additional climatic tests

Dry heat		IEC 60068-2 2	Compliant
	Conditions	Temperature	110 °C
		Duration of test	96 h
Cyclic damp heat		IEC 60068-2 30	Compliant
	Conditions	Temperature	55 °C
		Relative humidity	95 %
		Number of cycles (1 cycle = 24h)	2
Cold		IEC 60068-2 1	Compliant
	Conditions	Temperature	-55 °C
		Duration of test	96 h
Damp heat steady state		IEC 60068-2-78	Compliant
	Conditions	Temperature	40 °C
		Relative humidity	93 %
		Duration of test	96 h

Corrosion

Salt mist		IEC 60068-2 11	Compliant
	Conditions	Duration of test	1000 h
		Concentration	5 %
SO ₂		ISO 6988	Compliant
	Conditions	Duration of test	48 h
		Concentration	0.2 dm ³
Flowing mixed gas corrosion test		IEC 60068-2 60	Compliant
	Conditions	Number of the test method	3
		Duration of test	21 j

As part of its on-going product improvement, ABB reserves the right to modify the characteristics or the products described in this document. The information given is not contractual. For further details please contact the ABB company marketing these products in your country.

Vibrations and shocks

Sinusoidal vibrations		IEC 60068-2-6	Compliant
Conditions		Frequency range	5 ... 100 Hz
		Number of cycles	1
		Acceleration	7 m/s ²
Functional random vibrations		IEC 61373	Compliant
Category 1 Class B 3 axes		Conditions	Duration of test
		Frequency range	5 ... 150 Hz
		Acceleration	1 m/s ²
Long life testing at increased random vibrations		IEC 61373	Compliant
Category 1 Class B 3 axes		Conditions	Duration of test
		Frequency range	5 ... 150 Hz
		Acceleration	5.7 m/s ²
Shock		IEC 61373	Compliant
Category 1 Class B 3 axes		Conditions	Duration of test
		Acceleration	5 G

ZK2.5-PE-3P Terminal Block Accessories Compatibility

Some accessories may modify the terminal block's rating. See complete information in the accessories catalog page.

Description	Type	Order Code	Pack ^(ing) pieces	Weight g (1 pce)
1 End Stops	BAM3	1SNK900001R0000	50	13.80
	BAZ1	1SNK900002R0000	20	5.30
	BAZH1	1SNK900102R0000	20	23.90
2 End Sections	EK2.5-3P	1SNK705911R0000	20	2.4
3 Jumper Bars	JB5-2	1SNK905302R0000	50	1.30
	JB5-3	1SNK905303R0000	50	2.00
	JB5-4	1SNK905304R0000	50	2.70
	JB5-5	1SNK905305R0000	50	3.50
	JB5-10	1SNK905310R0000	30	7.10
	JB5-50	1SNK905350R0000	10	36.10
4 Cross Spacing Jumpers	JB85-3	1SNK900603R0000	10	2.80
5 Circuit Separators	CS-R3	1SNK900107R0000	20	6.4
6 Test Adapters	TP2	1SNK900203R0000	20	1.73
	TP4	1SNK900205R0000	20	2.41
7 Test Connectors	TC5	1SNK900200R0000	10	5.23
	TC5-R1	1SNK900201R0000	10	5.23
8 Mounting Rails	PR3.G2	1SNA164800R0300	2	
	PR4	1SNA168500R1200	2	915.00
	PR5	1SNA168700R2200	2	
	PR30	1SNA173220R0500	2	328.00
	PR3.Z2	1SNA174300R1700	2	
	PR50	1SNA178529R0400	2	1 288.00
9 Tools	PS-3	1SNK900650R0000	1	380.00
10 Terminal Block Markers	MC512	1SNK140000R0000	22	9.00
	MC512-YL	1SNK140004R0000	22	9.00
	MC512PA	1SNK149999R0000	20	10.00
	PROCAP5	1SNK900609R0000	20	0.69
	UMH	1SNK900611R0000	10	0.20
	SAT5	1SNK900614R0000	5	6.00

As part of its on-going product improvement, ABB reserves the right to modify the characteristics or the products described in this document. The information given is not contractual. For further details please contact the ABB company marketing these products in your country.

Contact us

ABB France
Low Voltage Products Division
Export Department
10, rue Ampère Z.I. - B.P. 114
F-69685 Chassieu cedex / France
Tel. +33 (0)4 7222 1722
Fax +33 (0)4 7222 1935

Note

We reserve the right to make technical changes or modify the contents of this document without prior notice. With regard to purchase orders, the agreed particulars shall prevail. ABB does not accept any responsibility whatsoever for potential errors or possible lack of information in this document.

We reserve all rights in this document and in the subject matter and illustrations contained therein. Any reproduction, disclosure to third parties or utilization of its contents – in whole or in parts – is forbidden without prior written consent of ABB.

Copyright© 2011 ABB
All rights reserved

1SNK162028D00201 - PDF