

ZS6-4S Screw Clamp Terminal Blocks Feed-through with 4 connections

- High density wiring (one potential distribution on 4 independent screw clamps) in a very low profile and just 6 mm 0.236 in spacing,
- Recommended for energy markets and highly demanding applications requiring that only one conductor be connected per clamp.

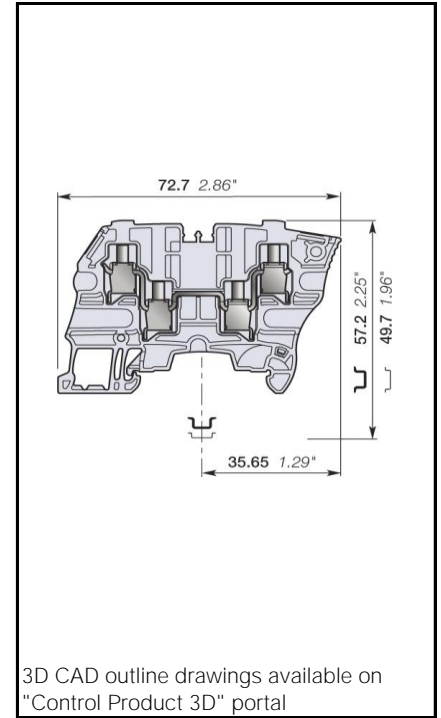
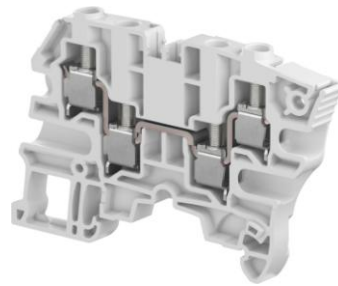

| | | |
|-----------------------|--|-------------------|
| | | 6 mm ² |
| | | 10 AWG |
| 6 mm 0.236 in Spacing | | |

Ordering Details

| Color | Type | Order Code | EAN Code | Pack ^(ing) | Weight (1 pce) | g |
|--------|-----------|-----------------|---------------|-----------------------|----------------|----|
| Grey | ZS6-4S | 1SNK506012R0000 | 3472595060122 | 50 | | 15 |
| Blue | ZS6-4S-BL | 1SNK506022R0000 | 3472595060221 | 50 | | 15 |
| Yellow | ZS6-4S-YL | 1SNK506068R0000 | 3472595060689 | 50 | | 15 |
| | | | | | | |
| | | | | | | |
| | | | | | | |
| | | | | | | |

Declarations and Certificates

| | | | | | | | |
|----|----|------|-----|--|--------|------|------------------|
| | | | | | | | |
| CE | CB | RoHS | USR | | Gost R | ATEX | IECEX |
| | | | | | | | ATEX Declaration |

Declarations and Certificates





| | | |
|---|------------------|----------------|
|  | CE | 1SND225081C10* |
|  | CB | 1SND161096A02* |
|  | RoHs | 1SND230491F02* |
|  | USR | 1SND161041A02* |
|  | CSA | 1SND161070A02* |
|  | GOST R | 1SND161005A11* |
|  | ATEX | 1SND162004A17* |
|  | IECEX | 1SND162005A17* |
|  | BV | 1SND161073A02* |
| Atex Declaration | Atex Declaration | 1SND225085C10* |

Explosive Atmosphere: ATEX Classification

| | |
|--|--------------------------|
| Group Category | Protection Method |
| IM2 II 2 GD Ex eb I/II/IIIC | Ex e: increased security |
| In the presence of explosive dust atmosphere, terminal blocks are to be installed in certified enclosure II 2D | |

General Information

The following information must be strictly adhered to in order to guarantee the terminal block electrical, mechanical and environmental performance.

| | | | | | | | |
|-----------------------|---|------------------------|----------------------------|---------------------------------------|--|-------------------|--|
| Protection | IEC 60947-1 | IP20 | NEMA250 | | | | |
| Rail |  | TH 35-7.5, TH 35-15 | | | | | |
| Wire stripping length |  | 10.5 mm | 0.413 in | | | | |
| | | Screw clamp | | Screw rail contact (Maximum value) | | Disconnect device | |
| Operating tool | | Flat screwdriver | | | | | |
| |  | 4 mm | 0.157 in | | | | |
| Torque |  | 0.75 N.m ± 0.05 N.m | 6.64 lb.in ± 0.44 lb.in | | | | |

Material Specifications

| | |
|---------------------|--|
| Insulating material | Polyamide |
| CTI | 600 V |
| Flammability | UL94 V0 |
| | NF F 16101 I2F2 |
| | Needle flame test.C 60615-11-5 Compliant |

Connecting capacity per clamp

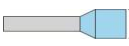
| | | Screw clamp | | |
|---|---|----------------------------|-------------------|--------|
| 1 Rigid - Solid / Stranded conductor | Norme | IEC60947-7-1 | UL1059 | |
| | Value | 0.2 ... 6 mm ² | 24 ... 10 AWG | |
| 1 Flexible conductor | Norme | IEC60947-7-1 | | |
| | Value | 0.22... 6 mm ² | | |
| 1 Flexible conductor with non insulated ferrule | Norme | Manufacturer data | Manufacturer data | |
| | Value | 0.22 ... 4 mm ² | 24 ... 12 AWG | |
| 1 Flexible conductor with insulated ferrule | Norme | Manufacturer data | Manufacturer data | |
| | Value | 0.22 ... 4 mm ² | 24 ... 12 AWG | |
| Gauge | | A4-B3 | 3 mm | |
| | | IEC 60947-1 | | |
| Ferrule maximum outer diameter or conductor insulation maximum outer diameter |  | ∅ Max. | Manufacturer data | 5.5 mm |

The "Connecting capacity with ferrule" data is guaranteed with ABB crimping tool PS-3 (crimping capacity up to 10 mm²).

As part of its on-going product improvement, ABB reserves the right to modify the characteristics or the products described in this document. The information given is not contractual. For further details please contact the ABB company marketing these products in your country.

Multi Connecting capacity per clamp

| | | | | |
|---|-------|------------------------------|-------------------|--|
| 2 Rigid - Solid / Stranded conductors | Norme | IEC60947-7-1 | UL1059 | |
| | Value | 0.2 ... 2.5 mm ² | 24 ... 14 AWG | |
| 2 Flexible conductors | Norme | IEC60947-7-1 | | |
| | Value | 0.2 ... 2.5 mm ² | | |
| 2 Flexible conductors with twin ferrule | Norme | Manufacturer data | Manufacturer data | |
| | Value | 0.22 ... 2.5 mm ² | 24 ... 14 AWG | |

Don't mix solid and flexible conductors in the same clamp

Don't mix solid or flexible conductors of different sizes in the same clamp

The "Connecting capacity with ferrule" data is guaranteed with ABB crimping tool PS-3 (crimping capacity up to 10 mm²)

Cross section

| | | | | |
|-----------------------|-------------------|-------------------|-------------------|--------|
| Rated cross section | IEC60947-7-1 | 4 mm ² | UL1059 | 10 AWG |
| Maximum Cross section | Manufacturer data | 6 mm ² | Manufacturer data | 10 AWG |

Electrical characteristics

Current

| | | | |
|---|--------------------------------|-------------------|--------------------------|
| Rated current | | IEC60947-7-1 | 32 A |
| | Field and factory wiring Cat.2 | UL 1059 | 30 A |
| | Factory wiring Cat.1 | UL 1059 | |
| | | CSA-C-22.2 n°158 | 30 A |
| Maximum Exe current | | IEC/EN 60079-7 | 29 A |
| Rated short-time withstand current 1 s (I _{cw}) | | IEC60947-7-1 | 480 A |
| Short-time withstand current | 0.5 s | Manufacturer data | |
| | 5 s | Manufacturer data | |
| | 10 s | Manufacturer data | |
| | 30 s | Manufacturer data | |
| | 1 min | Manufacturer data | |
| Rated short-circuit withstand current | | CSA-C-22.2 n°158 | |
| Max. current (45° temperature increase) / Max. cross section (mm ²) | | Manufacturer data | 39 A 6 mm ² |
| Maximum short circuit current (1s) | | Manufacturer data | 480 A |

Short Circuit Current Rating (SCCR) SA UL 1059 supplement

| | | | |
|------------------------------------|-------------------------------|---------|--------|
| SCCR | | UL 1059 | 100 kA |
| With the following configurations: | | | |
| | Suitable conductor wire range | | 10 AWG |
| | Maximum voltage | | 600 V |
| | Fuse class / Max. amp. Rating | J | 175 A |
| | | T | 175 A |
| | | RK1 | 100 A |
| | | RK5 | 60 A |
| | | G | 60 A |
| | | CC | 30 A |

Voltage

| | | |
|---------------------------------|------------------|--------|
| Rated voltage | IEC 60947-1 | 800 V |
| Rated voltage | UL 1059 | 600 V |
| Use Group | UL 1059 | B, C |
| Rated voltage | CSA-C-22.2 n°158 | 600 V |
| Rated voltage Ex e | IEC/ EN 60079-7 | 500 V |
| Rated impulse withstand voltage | IEC 60947-1 | 8000 V |
| Dielectric test voltage | IEC 60947-1 | 2000 V |
| Pollution degree | IEC 60947-1 | 3 |
| Overvoltage category | IEC 60947-1 | III |

Temperature range

| | | | |
|-----------------------------|------------|-----------------|-----------------|
| Ambient temperature min/max | Storage | -55 ... +110 °C | -67 ... +230 °F |
| | Installing | -5 ... +40 °C | -23 ... +104 °F |
| | Service | -55 ... +110 °C | -67 ... +230 °F |

Current Derating curve for continuous service temperature

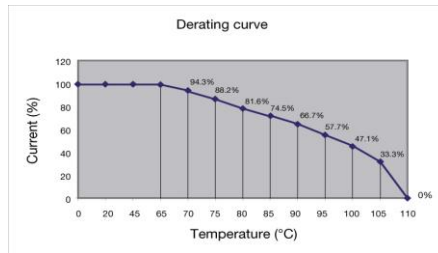

Dissipated power

| | | |
|---|-------------|-------|
| Maximum dissipated power at rated current | IEC 60947-1 | 1 W |
| Maximum dissipated power at maximum Exe current | IEC 60079-7 | 0.9 W |

Rated power dissipation at an ambient temperature of 23 °C - IEC 60947-7-3

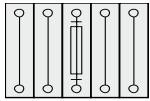
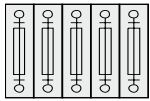
| | | |
|---|---|--|
| Separate arrangement / Overload and short-circuit protection |  <p>1 fuse and 4 feed-through blocks</p> | |
| Separate arrangement / Exclusive short-circuit protection | | |
| Compound arrangement / Overload and short-circuit protection |  <p>5 fuse blocks</p> | |
| Compound arrangement / Exclusive short-circuit protection | | |

Environmental Characteristics

Additional climatic tests

| | | | |
|------------------------|------------|----------------------------------|-----------|
| Dry heat | Conditions | IEC 60068-2 2 | Compliant |
| | | Temperature | 110 °C |
| | | Duration of test | 96 h |
| Cyclic damp heat | Conditions | IEC 60068-2 30 | Compliant |
| | | Temperature | 55 °C |
| | | Relative humidity | 95 % |
| | | Number of cycles (1 cycle = 24h) | 2 |
| Cold | Conditions | IEC 60068-2 1 | Compliant |
| | | Temperature | -55 °C |
| | | Duration of test | 96 h |
| Damp heat steady state | Conditions | IEC 60068-2 78 | Compliant |
| | | Temperature | 40 °C |
| | | Relative humidity | 93 % |
| | | Duration of test | 96 h |

Corrosion

| | | | |
|----------------------------------|------------|---------------------------|---------------------|
| Salt mist | Conditions | IEC 60068-2 11 | Compliant |
| | | Duration of test | 96 h |
| | | Concentration | 5 % |
| SO ₂ | Conditions | ISO 6988 | Compliant |
| | | Duration of test | 48 h |
| | | Concentration | 0.2 dm ³ |
| Flowing mixed gas corrosion test | Conditions | IEC 60068-2 60 | Compliant |
| | | Number of the test method | 3 |
| | | Duration of test | 21 j |

As part of its on-going product improvement, ABB reserves the right to modify the characteristics or the products described in this document. The information given is not contractual. For further details please contact the ABB company marketing these products in your country.

Vibrations and shocks

| | | | |
|--|------------|------------------|--------------------|
| Sinusoidal vibrations | | IEC 60068-2-6 | Compliant |
| Conditions | | Frequency range | 5 ... 100 Hz |
| | | Number of cycles | 1 |
| | | Acceleration | 7 m/s ² |
| Functional random vibrations | | IEC 61373 | |
| Category 1 Class B 3 axes | Conditions | Duration of test | |
| | | Frequency range | |
| | | Acceleration | |
| Long life testing at increased random vibrations | | IEC 61373 | |
| Category 1 Class B 3 axes | Conditions | Duration of test | |
| | | Frequency range | |
| | | Acceleration | |
| Shock | | IEC 61373 | |
| Category 1 Class B 3 axes | Conditions | Duration of test | |
| | | Acceleration | |

ZS6-4S Terminal Block Accessories Compatibility

Some accessories may modify the terminal block's rating. See complete information in the accessories catalog page.

| Description | Type | Order Code | Pack ^(ing) pieces | Weight g (1 pce) |
|---------------------------|----------|-----------------|---------------------------------|---------------------|
| 1 End Stops | BAM3 | 1SNK900001R0000 | 50 | 13.80 |
| | BAZ1 | 1SNK900002R0000 | 20 | 5.30 |
| 2 End Sections | ES6-4S | 1SNK505911R0000 | 20 | 3.1 |
| 3 Jumper Bars | JB6-2 | 1SNK906302R0000 | 50 | 1.30 |
| | JB6-3 | 1SNK906303R0000 | 50 | 2.10 |
| | JB6-4 | 1SNK906304R0000 | 50 | 2.90 |
| | JB6-5 | 1SNK906305R0000 | 50 | 3.60 |
| | JB6-10 | 1SNK906310R0000 | 20 | 7.40 |
| | JB6-50 | 1SNK906350R0000 | 10 | 38.10 |
| 4 Circuit Separators | CS | 1SNK900101R0000 | 20 | 0.20 |
| | CS-R1 | 1SNK900103R0000 | 20 | 5.20 |
| 5 Test Adapters | TP2 | 1SNK900203R0000 | 20 | 1.73 |
| | TP4 | 1SNK900205R0000 | 20 | 2.41 |
| 6 Test Connectors | TC5-R1 | 1SNK900201R0000 | 10 | 5.23 |
| 7 Spacers | ES-TC6 | 1SNK900105R0000 | 10 | 0.80 |
| 8 Mounting Rails | PR3.G2 | 1SNA164800R0300 | 2 | |
| | PR4 | 1SNA168500R1200 | 2 | 915.00 |
| | PR5 | 1SNA168700R2200 | 2 | |
| | PR30 | 1SNA173220R0500 | 2 | 328.00 |
| | PR3.Z2 | 1SNA174300R1700 | 2 | |
| | PR50 | 1SNA178529R0400 | 2 | 1 288.00 |
| 9 Tools | PS-3 | 1SNK900650R0000 | 1 | 380.00 |
| 10 Terminal Block Markers | MC512 | 1SNK140000R0000 | 22 | 9.00 |
| | MC512-YL | 1SNK140004R0000 | 22 | 9.00 |
| | MC512PA | 1SNK149999R0000 | 20 | 10.00 |
| | MC612 | 1SNK150000R0000 | 22 | 10.00 |
| | MC612-YL | 1SNK150004R0000 | 22 | 10.00 |
| | MC612PA | 1SNK159999R0000 | 20 | 11.00 |
| | UMH | 1SNK900611R0000 | 10 | 0.20 |
| | PROCAP6 | 1SNK900612R0000 | 20 | 0.78 |
| | SAT6 | 1SNK900615R0000 | 5 | 6.00 |
| | SAT | 1SNK900623R0000 | 5 | 6.00 |

As part of its on-going product improvement, ABB reserves the right to modify the characteristics or the products described in this document. The information given is not contractual. For further details please contact the ABB company marketing these products in your country.

Contact us

ABB France
Low Voltage Products Division
Export Department
10, rue Ampère Z.I. - B.P. 114
F-69685 Chassieu cedex / France
Tel. +33 (0)4 7222 1722
Fax +33 (0)4 7222 1935

Note

We reserve the right to make technical changes or modify the contents of this document without prior notice. With regard to purchase orders, the agreed particulars shall prevail. ABB does not accept any responsibility whatsoever for potential errors or possible lack of information in this document.

We reserve all rights in this document and in the subject matter and illustrations contained therein. Any reproduction, disclosure to third parties or utilization of its contents – in whole or in parts – is forbidden without prior written consent of ABB.

Copyright© 2011 ABB
All rights reserved

1SNK161073D0201 - PDF