



### Silicon NPN Phototransistor



#### DESCRIPTION

VEMT2523SLX01 is a silicon NPN epitaxial planar phototransistor in a miniature side looking, surface mount package (SMD) with clear epoxy dome lens. The device is sensitive to visible and near infrared radiation.

#### FEATURES

- Package type: surface mount
- Package form: side view
- Dimensions (L x W x H in mm): 2.3 x 2.55 x 2.3
- AEC-Q101 qualified
- High radiant sensitivity
- Suitable for visible and near infrared radiation
- Fast response times
- Angle of half sensitivity:  $\phi = \pm 35^\circ$
- Package matched with IR emitter series VSMB2943SLX01
- Floor life: 4 weeks, MSL 2a, acc. J-STD-020
- Lead (Pb)-free reflow soldering
- Material categorization: For definitions of compliance please see [www.vishay.com/doc?99912](http://www.vishay.com/doc?99912)

AUTOMOTIVE GRADE



RoHS COMPLIANT  
HALOGEN FREE  
GREEN (5-2008)

#### APPLICATIONS

- Detector in automotive applications
- Photo interrupters
- Miniature switches
- Counters
- Encoders
- Position sensors

PRODUCT SUMMARY			
COMPONENT	I <sub>ca</sub> (mA)	$\phi$ (deg)	$\lambda_{0.1}$ (nm)
VEMT2523SLX01	2.7	$\pm 35$	470 to 1090

#### Note

- Test condition see table "Basic Characteristics"

ORDERING INFORMATION			
ORDERING CODE	PACKAGING	REMARKS	PACKAGE FORM
VEMT2523SLX01	Tape and reel	MOQ: 3000 pcs, 3000 pcs/reel	Side view

#### Note

- MOQ: minimum order quantity



<b>ABSOLUTE MAXIMUM RATINGS</b> ( $T_{amb} = 25\text{ }^{\circ}\text{C}$ , unless otherwise specified)				
PARAMETER	TEST CONDITION	SYMBOL	VALUE	UNIT
Collector emitter voltage		$V_{CEO}$	20	V
Emitter collector voltage		$V_{ECO}$	7	V
Collector current		$I_C$	50	mA
Power power dissipation	$T_{amb} \leq 75\text{ }^{\circ}\text{C}$	$P_V$	100	mW
Junction temperature		$T_j$	100	$^{\circ}\text{C}$
Operating temperature range		$T_{amb}$	- 40 to + 100	$^{\circ}\text{C}$
Storage temperature range		$T_{stg}$	- 40 to + 100	$^{\circ}\text{C}$
Soldering temperature	Acc. reflow profile fig. 8	$T_{sd}$	260	$^{\circ}\text{C}$
Thermal resistance junction/ambient	Acc. J-STD-051	$R_{thJA}$	250	K/W

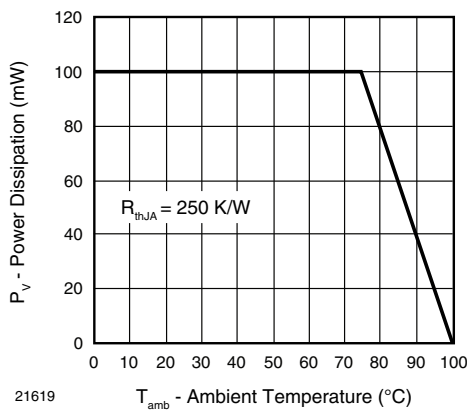

Fig. 1 - Power Dissipation Limit vs. Ambient Temperature

<b>BASIC CHARACTERISTICS</b> ( $T_{amb} = 25\text{ }^{\circ}\text{C}$ , unless otherwise specified)						
PARAMETER	TEST CONDITION	SYMBOL	MIN.	TYP.	MAX.	UNIT
Collector emitter breakdown voltage	$I_C = 0.1\text{ mA}$	$V_{CEO}$	20			V
Collector dark current	$V_{CE} = 5\text{ V}, E = 0$	$I_{CEO}$		1	100	nA
Collector emitter capacitance	$V_{CE} = 0\text{ V}, f = 1\text{ MHz}, E = 0$	$C_{CEO}$		25		pF
Collector light current	$E_e = 1\text{ mW/cm}^2, \lambda = 950\text{ nm}, V_{CE} = 5\text{ V}$	$I_{ca}$	1.3	2.7	4.1	mA
Angle of half sensitivity		$\phi$		$\pm 35$		deg
Wavelength of peak sensitivity		$\lambda_p$		850		nm
Range of spectral bandwidth		$\lambda_{0.1}$		470 to 1090		nm
Collector emitter saturation voltage	$I_C = 0.05\text{ mA}$	$V_{CEsat}$			0.4	V
Temperature coefficient of $I_{ca}$	$E_e = 1\text{ mW/cm}^2, \lambda = 950\text{ nm}, V_{CE} = 5\text{ V}$	$Tk_{Ica}$		1.1		%/K

**BASIC CHARACTERISTICS** ( $T_{amb} = 25\text{ }^{\circ}\text{C}$ , unless otherwise specified)



Fig. 2 - Collector Dark Current vs. Ambient Temperature

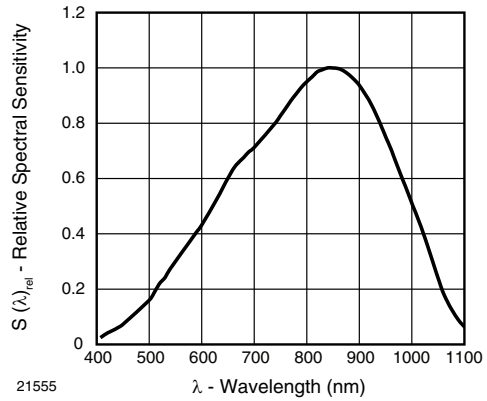

Fig. 5 - Relative Spectral Sensitivity vs. Wavelength

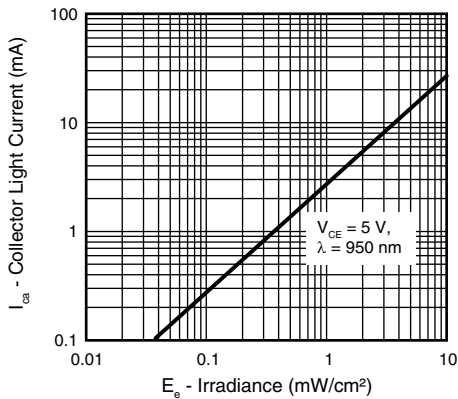

Fig. 3 - Collector Light Current vs. Irradiance

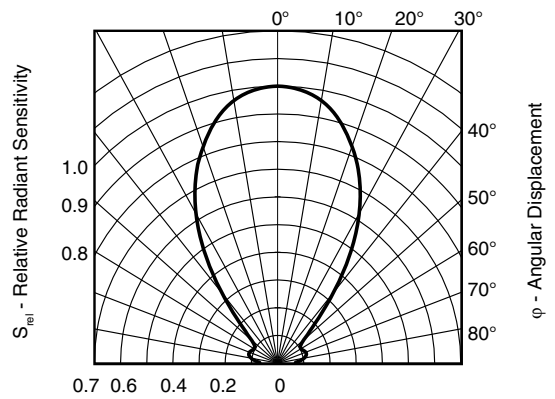

Fig. 6 - Relative Radiant Sensitivity vs. Angular Displacement

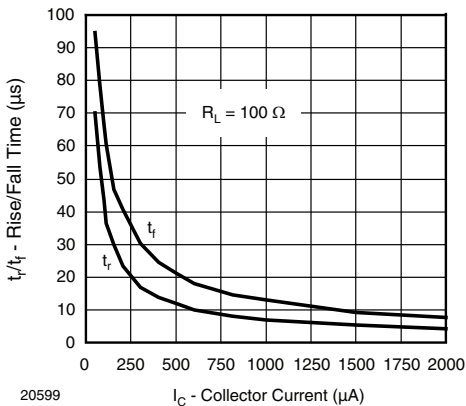

Fig. 4 - Rise/Fall Time vs. Collector Current

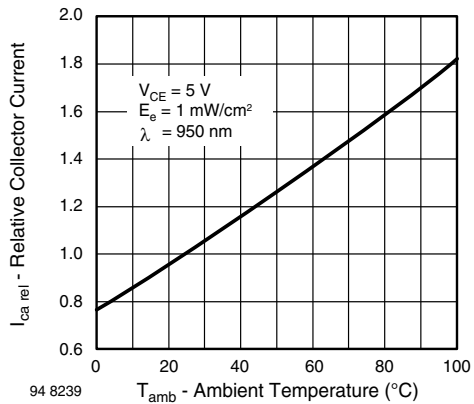

Fig. 7 - Relative Collector Current vs. Ambient Temperature

**REFLOW SOLDER PROFILE**

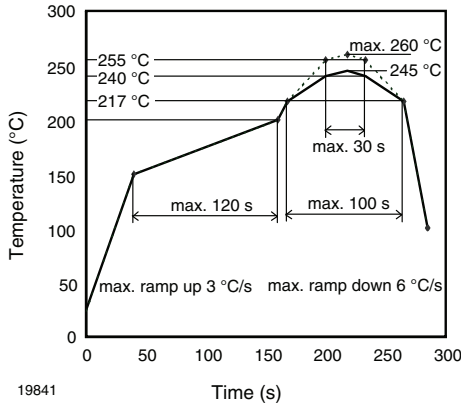

Fig. 8 - Lead (Pb)-free Reflow Solder Profile acc. J-STD-020

**DRYPACK**

Devices are packed in moisture barrier bags (MBB) to prevent the products from moisture absorption during transportation and storage. Each bag contains a desiccant.

**FLOOR LIFE**

Floor life (time between soldering and removing from MBB) must not exceed the time indicated on MBB label:  
Floor life: 4 weeks  
Conditions:  $T_{amb} < 30\text{ }^{\circ}\text{C}$ ,  $RH < 60\%$   
Moisture sensitivity level 2a, acc. to J-STD-020.

**DRYING**

In case of moisture absorption devices should be baked before soldering. Conditions see J-STD-020 or label. Devices taped on reel dry using recommended conditions 192 h at  $40\text{ }^{\circ}\text{C}$  ( $+ 5\text{ }^{\circ}\text{C}$ ),  $RH < 5\%$ .

**PACKAGE DIMENSIONS VEMT2523SLX01** in millimeters

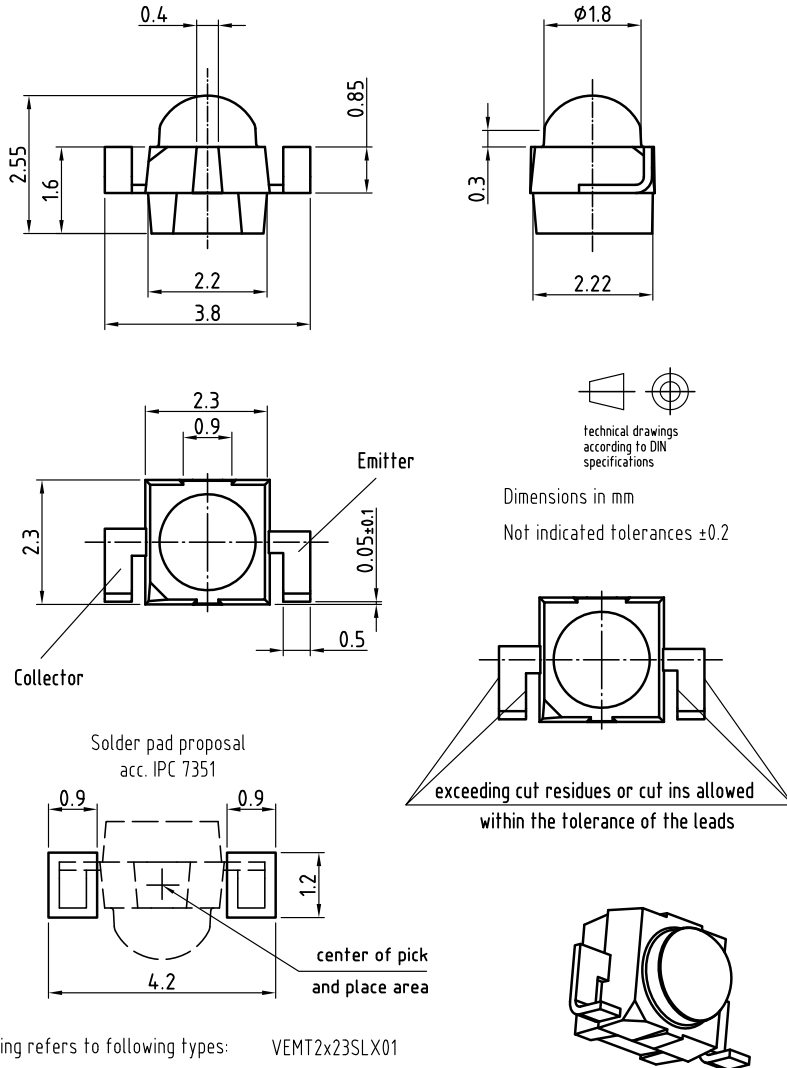

Drawing refers to following types: VEMT2x23SLX01

Drawing-No.: 6.544-5410.01-4  
Issue: prel. 03.08.12

**TAPE AND REEL DIMENSIONS VENT2523SLX01** in millimeters



Leader and tailer tape:



Terminal position in tape

Device	Lead I	Lead II
VSMB2943SLX01	Cathode	Anode
VSMF2893SLX01		
VSMB2948SL		
VEMD2023SLX01		
VEMD2523SLX01	Collector	Emitter
VENT2023SLX01		
VENT2523SLX01	Anode	Cathode



Drawing refers to following types: see table  
Reel dimensions and tape

Drawing-No.: 9.800-5123.01-4  
Issue: 2; 19.02.13



## Disclaimer

ALL PRODUCT, PRODUCT SPECIFICATIONS AND DATA ARE SUBJECT TO CHANGE WITHOUT NOTICE TO IMPROVE RELIABILITY, FUNCTION OR DESIGN OR OTHERWISE.

Vishay Intertechnology, Inc., its affiliates, agents, and employees, and all persons acting on its or their behalf (collectively, "Vishay"), disclaim any and all liability for any errors, inaccuracies or incompleteness contained in any datasheet or in any other disclosure relating to any product.

Vishay makes no warranty, representation or guarantee regarding the suitability of the products for any particular purpose or the continuing production of any product. To the maximum extent permitted by applicable law, Vishay disclaims (i) any and all liability arising out of the application or use of any product, (ii) any and all liability, including without limitation special, consequential or incidental damages, and (iii) any and all implied warranties, including warranties of fitness for particular purpose, non-infringement and merchantability.

Statements regarding the suitability of products for certain types of applications are based on Vishay's knowledge of typical requirements that are often placed on Vishay products in generic applications. Such statements are not binding statements about the suitability of products for a particular application. It is the customer's responsibility to validate that a particular product with the properties described in the product specification is suitable for use in a particular application. Parameters provided in datasheets and/or specifications may vary in different applications and performance may vary over time. All operating parameters, including typical parameters, must be validated for each customer application by the customer's technical experts. Product specifications do not expand or otherwise modify Vishay's terms and conditions of purchase, including but not limited to the warranty expressed therein.

Except as expressly indicated in writing, Vishay products are not designed for use in medical, life-saving, or life-sustaining applications or for any other application in which the failure of the Vishay product could result in personal injury or death. Customers using or selling Vishay products not expressly indicated for use in such applications do so at their own risk. Please contact authorized Vishay personnel to obtain written terms and conditions regarding products designed for such applications.

No license, express or implied, by estoppel or otherwise, to any intellectual property rights is granted by this document or by any conduct of Vishay. Product names and markings noted herein may be trademarks of their respective owners.

## Material Category Policy

**Vishay Intertechnology, Inc. hereby certifies that all its products that are identified as RoHS-Compliant fulfill the definitions and restrictions defined under Directive 2011/65/EU of The European Parliament and of the Council of June 8, 2011 on the restriction of the use of certain hazardous substances in electrical and electronic equipment (EEE) - recast, unless otherwise specified as non-compliant.**

**Please note that some Vishay documentation may still make reference to RoHS Directive 2002/95/EC. We confirm that all the products identified as being compliant to Directive 2002/95/EC conform to Directive 2011/65/EU.**

**Vishay Intertechnology, Inc. hereby certifies that all its products that are identified as Halogen-Free follow Halogen-Free requirements as per JEDEC JS709A standards. Please note that some Vishay documentation may still make reference to the IEC 61249-2-21 definition. We confirm that all the products identified as being compliant to IEC 61249-2-21 conform to JEDEC JS709A standards.**