

Global Plus Connector Cables



Multi-Connector Blocks



- 10.0 Introduction**
 - Product Selection Guide **V8-T10-2**
- 10.1 Global Plus Connector Cables**
 - Product Description **V8-T10-3**
 - Standards and Certifications **V8-T10-3**
 - Product Selection Guide **V8-T10-4**
 - Catalog Number Selection **V8-T10-4**
 - Product Selection **V8-T10-5**
 - Accessories **V8-T10-9**
 - Technical Data and Specifications **V8-T10-10**
 - Wiring Diagrams **V8-T10-10**
 - Dimensions **V8-T10-11**
- 10.2 Multi-Connector Blocks**
 - Product Description **V8-T10-13**
 - Application Description **V8-T10-13**
 - Features **V8-T10-13**
 - Standards and Certifications **V8-T10-13**
 - Product Selection **V8-T10-14**
 - Accessories **V8-T10-14**
 - Technical Data and Specifications **V8-T10-14**
 - Wiring Diagrams **V8-T10-15**
 - Dimensions **V8-T10-15**



Unless otherwise noted, the products contained in this section should not be used for functional safety applications. These products were not designed or tested to IEC 60947-5-3 or recommended for functional safety.



For Customer Service in the U.S. call 1-877-ETN CARE (386-2273),
in Canada call 1-800-268-3578.
For Application Assistance in the U.S. and Canada
call 1-800-426-9184.

Product Selection Guide

Global Plus Connector Cables



Page V8-T10-3

Overview

Finish your sensor installation with high quality Connector Cables from Eaton's Electrical Sector. Our Global Plus line is designed to give you everything you want without paying extra for the features you don't want. It includes a wide variety of single- and double-connector cables in a variety of sizes (mini, micro, nano), lengths and jacket materials to fit any application

Sensing Types and Ranges

Nano (M8)
 Micro (M12)
 Mini
 Double-ended, straight, right-angle, and field-installable connector styles

Product Features

Industry standard connector types
 Industrial-duty polymer jackets consisting of PVC, PUR, or Irradiated PUR
 Stranded copper conductors and polymer jackets provide a high resistance to bending motions
 Right angle units for applications that have constricted space

Technical Data and Specifications

Operating voltage—
 0–600 Vac/dc
 Maximum load current—
 0–13A
 Enclosure ratings—
 NEMA 6P, IP68

Approvals

UL®
 cUL®
 CSA®



Multi-Connector Blocks



Page V8-T10-13

Overview

Junction Blocks from Eaton's Electrical Sector allow users to quickly connect multiple sensors through one source of power

Sensing Types and Ranges

4-, 6- or 8-ports
 Cable or connector models
 Micro connector style

Product Features

LED status indicators for power and output status
 Molded PUR cable models provide added protection from moisture and most cutting fluids
 Pluggable terminal blocks provide easy and quick installation

Technical Data and Specifications

Operating voltage—
 0–30 Vdc
 Maximum load current—
 4A per port
 Enclosure ratings—
 IP65

Approvals

cUL



Global Plus Connector Cables



Global Plus Connector Cables

Product Description

Finish your sensor installation with high quality connector cables from Eaton's Electrical Sector. Our Global Plus line is designed to give you everything you want without paying extra for the features you don't want. It includes a wide variety of single- and double-connector cables. Custom lengths are available upon request from the factory.

Standards and Certifications

- UL Recognized (Mini-Style)
- CSA Certified (Mini- and Nano-Styles)
- cUL Recognized (Micro- and Nano-Styles)



Contents

<i>Description</i>	<i>Page</i>
Global Plus Connector Cables	
Product Selection Guide	V8-T10-4
Catalog Number Selection	V8-T10-4
Product Selection	
Single Connector Cables	V8-T10-5
Double Connector Cables	V8-T10-8
Receptacles—Micro and Mini	V8-T10-9
Accessories	V8-T10-9
Technical Data and Specifications	V8-T10-10
Wiring Diagrams	V8-T10-10
Dimensions	V8-T10-11

DANGER

THIS SENSOR IS NOT A SAFETY DEVICE AND IS NOT INTENDED TO BE USED AS A SAFETY DEVICE. This sensor is designed only to detect and read certain data in an electronic manner and perform no use apart from that, specifically no safety-related use. This sensor product does not include self-checking redundant circuitry, and the failure of this sensor product could cause either an energized or de-energized output condition, which could result in death, serious bodily injury, or property damage.

For the most current information on this product, visit our Web site: www.eaton.com

For Customer Service in the U.S. call 1-877-ETN CARE (386-2273), in Canada call 1-800-268-3578.
For Application Assistance in the U.S. and Canada call 1-800-426-9184.

10.1

Sensor Connectivity





Global Plus Connector Cables

Product Selection Guide

What Type of Connector Cable Do You Need?

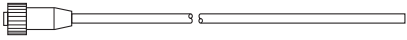
The majority of the sensors in this Product Guide are available with connectors for quick-disconnect installation.

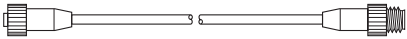
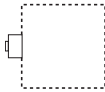
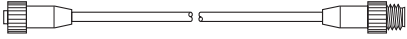
Global Plus Connector Cable Selection

Sensor	Connector Cable Type	Style	Interfaces with ...	Style
	Single-Connector Cable		Junction Box or Control Panel	
		Micro (see Page V8-T10-5)	For hard-wiring into a typical junction box or control panel.	
		Mini (see Page V8-T10-6)		
		Nano (see Page V8-T10-7)		
	Double-Connector Cable		Connectorized Junction Box or Control Panel	
		Micro (see Page V8-T10-8)	For connecting to a junction box or control panel that has a receptacle connector interface.	
		Mini (see Page V8-T10-8)		
	Double-Connector Cable		Multi-Connector Block with Cable	
		Micro (see Page V8-T10-8)	Allows up to eight sensors to be consolidated into one cable for wiring to your control system	

10

Catalog Number Selection

Global Plus Connector Cables ①

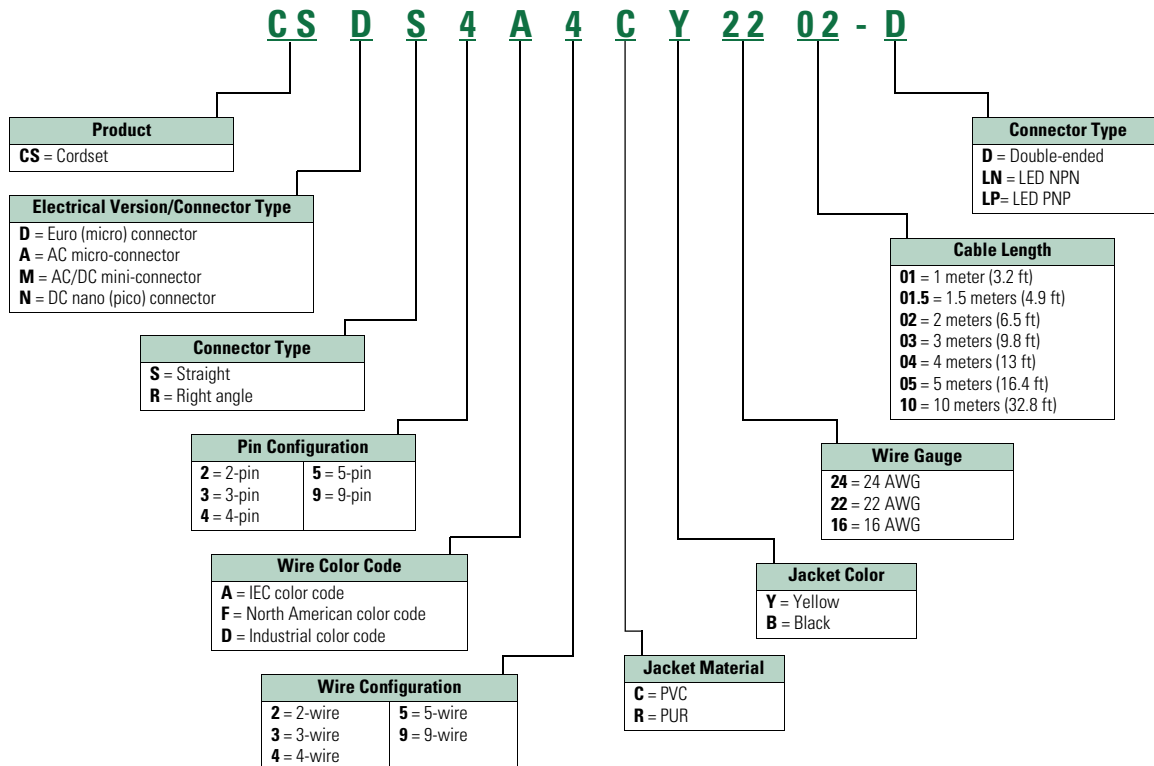

Note

① This is a representative guide to the catalog numbering system. All possible combinations may not be available for ordering. Please verify the number with the following pages or call Application Support at (800) 426-9194 before ordering.

Product Selection

Single Connector Cables

Micro-Style Straight Female



Micro-Style Straight Female

Voltage Style	Number of Pins	Gauge	Length	Pin Configuration/Wire Colors (Face View Female Shown)	PVC Jacket Catalog Number	PUR Jacket Catalog Number			
Standard Cables									
AC	3-pin, 3-wire	18 AWG	6.0 ft (2m)		CSAS3F3CY1802	—			
			16.4 ft (5m)		CSAS3F3CY1805	—			
			32.8 ft (10m)		CSAS3F3CY1810	—			
		22 AWG	6.0 ft (2m)		CSAS3F3CY2202	CSAS3F3RY2202			
			16.4 ft (5m)		CSAS3F3CY2205	CSAS3F3RY2205			
			32.8 ft (10m)		CSAS3F3CY2210	CSAS3F3RY2210			
			4-pin, 4-wire		18 AWG	6.0 ft (2m)		CSAS4F4CY1802	—
						16.4 ft (5m)		CSAS4F4CY1805	—
						32.8 ft (10m)		CSAS4F4CY1810	—
	22 AWG	6.0 ft (2m)		CSAS4F4CY2202	CSAS4F4RY2202				
		16.4 ft (5m)		CSAS4F4CY2205	CSAS4F4RY2205				
		32.8 ft (10m)		CSAS4F4CY2210	CSAS4F4RY2210				
		22 AWG		4-pin, 4-wire	6.0 ft (2m)		CSAS4A4CY2202	—	
							16.4 ft (5m)	CSAS4A4CY2205	—
							32.8 ft (10m)	CSAS4A4CY2210	—
22 AWG	5-pin, 5-wire	6.0 ft (2m)		CSAS5A5CY2202	—				
				16.4 ft (5m)	CSAS5A5CY2205	—			
				32.8 ft (10m)	CSAS5A5CY2210	—			
DC	4-pin, 3-wire	22 AWG	6.0 ft (2m)		CSDS4A3CY2202	CSDS4A3RY2202			
			16.4 ft (5m)		CSDS4A3CY2205	CSDS4A3RY2205			
			32.8 ft (10m)		CSDS4A3CY2210	CSDS4A3RY2210			
	4-pin, 4-wire	22 AWG	6.0 ft (2m)		CSDS4A4CY2202	CSDS4A4RY2202			
			16.4 ft (5m)		CSDS4A4CY2205	CSDS4A4RY2205			
			32.8 ft (10m)		CSDS4A4CY2210	CSDS4A4RY2210			
			65.6 ft (20m)		CSDS4A4CY2220	—			
			5-pin, 5-wire		22 AWG	6.0 ft (2m)		CSDS5A5CY2202	—
								16.4 ft (5m)	CSDS5A5CY2205
	32.8 ft (10m)	CSDS5A5CY2210		—					
	8-pin, 8-wire	24 AWG	16.4 ft (5m)		CSDS8A8CB2405	—			
			32.8 ft (10m)		CSDS8A8CB2410	—			

10.1

Sensor Connectivity

Global Plus Connector Cables

10

Micro-Style Right Angle Female



Micro-Style Right Angle Female

Voltage Style	Number of Pins	Gauge	Length	Pin Configuration/Wire Colors (Face View Female Shown)	PVC Jacket Catalog Number	PUR Jacket Catalog Number		
Standard Cables								
AC	3-pin, 3-wire	18 AWG	6.0 ft (2m)		CSAR3F3CY1802	—		
			16.4 ft (5m)				CSAR3F3CY1805	
			32.8 ft (10m)				CSAR3F3CY1810	
		22 AWG	6.0 ft (2m)		CSAR3F3CY2202	CSAR3F3RY2202		
			16.4 ft (5m)		CSAR3F3CY2205	CSAR3F3RY2205		
			32.8 ft (10m)		CSAR3F3CY2210	CSAR3F3RY2210		
	4-pin, 4-wire	18 AWG	6.0 ft (2m)		CSAR4F4CY1802	—		
			16.4 ft (5m)				CSAR4F4CY1805	
			32.8 ft (10m)				CSAR4F4CY1810	
		22 AWG	6.0 ft (2m)		CSAR4F4CY2202	CSAR4F4RY2202		
			16.4 ft (5m)		CSAR4F4CY2205	CSAR4F4RY2205		
			32.8 ft (10m)		CSAR4F4CY2210	CSAR4F4RY2210		
DC	4-pin, 3-wire	22 AWG	6.0 ft (2m)		CSDR4A3CY2202	CSDR4A3RY2202		
			16.4 ft (5m)				CSDR4A3CY2205	CSDR4A3RY2205
			32.8 ft (10m)				CSDR4A3CY2210	CSDR4A3RY2210
	4-pin, 4-wire	22 AWG	6.0 ft (2m)		CSDR4A4CY2202	CSDR4A4RY2202		
			16.4 ft (5m)				CSDR4A4CY2205	CSDR4A4RY2205
			32.8 ft (10m)				CSDR4A4CY2210	CSDR4A4RY2210
	5-pin, 5-wire	22 AWG	6.0 ft (2m)		CSDR5A5CY2202	—		
			16.4 ft (5m)				CSDR5A5CY2205	
			32.8 ft (10m)				CSDR5A5CY2210	

Mini-Style Straight Female



Mini-Style Straight Female

Current Rating at 600V	Voltage Style	Number of Pins	Gauge	Length	Pin Configuration/Wire Colors (Face View Female Shown)	Catalog Number
Standard Cables						
13A	AC/DC	2-pin, 2-wire	16 AWG	6 ft (2m)		CSMS2D2CY1602
				12 ft (4m)		CSMS2D2CY1604
13A		3-pin, 3-wire	16 AWG	6 ft (2m)		CSMS3F3CY1602
				12 ft (4m)		CSMS3F3CY1604
10A		4-pin, 4-wire	16 AWG	6 ft (2m)		CSMS4F4CY1602
				12 ft (4m)		CSMS4F4CY1604

**Mini-Style
Straight Female**

Mini-Style Straight Female, continued

Current Rating at 600V	Voltage Style	Number of Pins	Gauge	Length	Pin Configuration/Wire Colors (Face View Female Shown)	Catalog Number
Standard Cables						
10A	AC/DC	4-pin, 4-wire	16 AWG	6 ft (2m)		CSMS4A4CY1602
				13.12 ft (4m)		CSMS4A4CY1604
				19.69 ft (6m)		CSMS4A4CY1606
8A		5-pin, 5-wire	16 AWG	6 ft (2m)		CSMS5D5CY1602
				12 ft (4m)		CSMS5D5CY1604
8A		5-pin, 5-wire	16 AWG	6 ft (2m)		CSMS5A5CY1602
				13.12 ft (4m)		CSMS5A5CY1604
				19.69 ft (6m)		CSMS5A5CY1606
7A		9-pin, 9-wire	16 AWG	6 ft (2m)		CSMS9D9CY1602

**Nano-Style
Straight Female**

Nano-Style Straight Female

Voltage Style	Number of Pins	Gauge	Length	Pin Configuration/Wire Colors (Face View Female Shown)	PVC Jacket Catalog Number	PUR Jacket Catalog Number
Standard Cables						
—	3-pin, 3-wire	24 AWG	6.0 ft (2m)		CSNS3A3CY2402	CSNS3A3RY2402
			16.4 ft (5m)		CSNS3A3CY2405	CSNS3A3RY2405
			32.8 ft (10m)		CSNS3A3CY2410	CSNS3A3RY2410
DC	4-pin, 4-wire	24 AWG	6.5 ft (2m)		CSNS4A4CY2402	—
			16.4 ft (5m)		CSNS4A4CY2405	—
			32.8 ft (10m)		CSNS4A4CY2410	—

**Nano-Style
Right Angle Female**

Nano-Style Right Angle Female

Voltage Style	Number of Pins	Gauge	Length	Pin Configuration/Wire Colors (Face View Female Shown)	PVC Jacket Catalog Number	PUR Jacket Catalog Number
Standard Cables						
—	3-pin, 3-wire	24 AWG	6.0 ft (2m)		CSNR3A3CY2402	CSNR3A3RY2402
			16.4 ft (5m)		CSNR3A3CY2405	CSNR3A3RY2405
			32.8 ft (10m)		CSNR3A3CY2410	CSNR3A3RY2410

10.1

Sensor Connectivity

Global Plus Connector Cables

Double Connector Cables

Micro-Style Straight Female/Male



Micro-Style Straight Female/Male

Voltage Style	Number of Pins	Gauge	Length	Pin Configuration/Wire Colors (Face View Female Shown)	Catalog Number
DC	4-pin	22 AWG	3.0 ft (1m)		CSDS4A4CY2201-D
			5.0 ft (1.5m)		CSDS4A4CY2201.5-D
			6.0 ft (2m)		CSDS4A4CY2202-D
			10.0 ft (3m)		CSDS4A4CY2203-D
			16.4 ft (5m)		CSDS4A4CY2205-D
DC	5-pin	22 AWG	3.0 ft (1m)		CSDS5A5CY2201-D
			10.0 ft (3m)		CSDS5A5CY2203-D
			16.4 ft (5m)		CSDS5A5CY2205-D

10

Micro-Style Straight Female/Right Angle Male



Micro-Style Straight Female/Right Angle Male

Voltage Style	Number of Pins	Gauge	Length	Pin Configuration/Wire Colors (Face View Female Shown)	Catalog Number
DC	4-pin	22 AWG	3.0 ft (1m)		CSDR4A4CY2201-D
			5.0 ft (1.5m)		CSDR4A4CY2201.5-D
			6.0 ft (2m)		CSDR4A4CY2202-D
			10.0 ft (3m)		CSDR4A4CY2203-D
			16.4 ft (5m)		CSDR4A4CY2205-D

Receptacles—Micro and Mini

Micro-Style Straight Male



Micro and Mini

Voltage Style	Number of Pins	Gauge	Length	Mounting Hole Size	Pin Configuration	Catalog Number
Standard Cables—Micro						
DC	4-pin, 4-wire	22 AWG	1.0 ft (0.3m)	1/2 in NPT	1-Brown 2-White 3-Blue 4-Black	CSDS4A4CMR22.3
	5-pin, 5-wire	22 AWG	1.6 ft (0.5m)	PG9	1-Brown 2-White 3-Blue 4-Black 5-Gray	CSDS5A5CMR.5

Mini-Style Straight Male



Standard Cables—Mini

AC/DC	4-pin, 4-wire	22 AWG	1.6 ft (0.5m)	1/2 in NPT	1-Brown 2-White 3-Blue 4-Black	CSMS4A4CMR16.5
-------	---------------	--------	---------------	------------	---	-----------------------

Accessories

Global Plus Accessories

Field Wireable, Plastic



Description	Catalog Number
Micro female style, straight, four-position	CSDS4
Micro female style, right angle, four-position	CSDR4
Micro male style, straight, four-position	CSDSM4
Micro male style, right angle, four-position	CSDRM4
Nano female style, straight, three-position	CSNS3
Nano male style, straight, three-position	CSNSM3
Nano male style, straight, four-position	CSNSM4
Nano female style, straight, four-position	CSNS4
Nano female style, right angle, four-position	CSNR4
Micro female style, y-splitter, three-position	CSDY3 ①
Micro female style, y-splitter, five-position	CSDY5 ①

Closure Cap



Description	Catalog Number
Seals off unused connector ports on multi-connector blocks, micro female type	CBCAP
Seals off unused parts on micro, male type	CBMCAP

Bulk Cable, Micro-Style



Description	Catalog Number
Four-conductor, 22 AWG, yellow jacket (blue, brown, white, black), compatible with micro-style field wireable connectors shown above	CS4ACY22XX ②

Bulk Cable, Nano Style



Description	Catalog Number
Three-conductor, 24 AWG, yellow jacket (brown, blue, black), compatible with field wireable connectors shown above	CS3ACY24XX ①

Notes

- ① For wiring diagrams explaining the difference between three- and five-position models, see Wiring Diagrams on **Page V8-T10-10**.
- ② Quantity ordered indicates length (for example, quantity of 5 equals 5 ft).

Technical Data and Specifications

Global Plus Connector Cables

Description	Micro-Style Specification	Mini-Style Specification	Nano-Style Specification
Jacket material	PVC/PUR/Irradiated PUR ^①	PVC	PVC/PUR ^①
Contact material	Gold-plated copper alloy	Gold-plated brass	Gold-plated copper alloy
Coupling nut material	Nickel-plated die-cast zinc	Nickel-plated die-cast zinc	Nickel-plated die-cast zinc
O-ring	Nitrile rubber	None	Nitrile rubber
Cable	PVC/PUR/Irradiated PUR, insulation and jacket, stranded copper conductors	PVC/PUR/Irradiated PUR, insulation and jacket, stranded copper conductors	PVC/PUR/Irradiated PUR, insulation and jacket, stranded copper conductors
Cable strain relief	35 lbs minimum	35 lbs minimum	35 lbs minimum
Voltage rating	320V (24 Vdc for LED plugs) (30 Vdc for 8-pin, versions)	600V	100 Vdc
Current rating	4A	See model selection chart	4A
Contact resistance	5M ohms maximum	5M ohms maximum	5M ohms maximum
Isolation resistance	1000M ohms minimum	1000M ohms minimum	1000M ohms minimum
Protection	IP67	NEMA 6P, IP68	IP67
Temperature range	-13° to 176°F (-25° to 80°C)	-4° to 221°F (-20° to 105°C)	-4° to 221°F (-20° to 105°C)
Cable diameter	See Dimensions on Page V8-T10-11.	See Dimensions on Page V8-T10-11.	See Dimensions on Page V8-T10-11.
Bend radius	Minimum recommended bend radius is 12X cable diameter	Minimum recommended bend radius is 12X cable diameter	Minimum recommended bend radius is 12X cable diameter

Wiring Diagrams

CSDY3

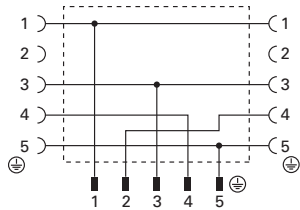

CSDY5

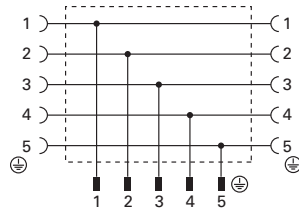

Note

^① Jacket material dependent upon model selection.

Dimensions

Approximate Dimensions in Inches (mm)

Single Connector Cable Dimensions

Micro-Style Single Connector Cables, Straight Female

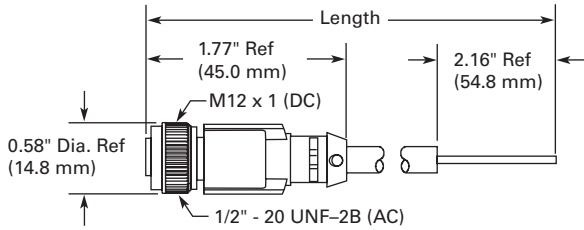

Micro-Style Single Connector Cables, Right Angle Female

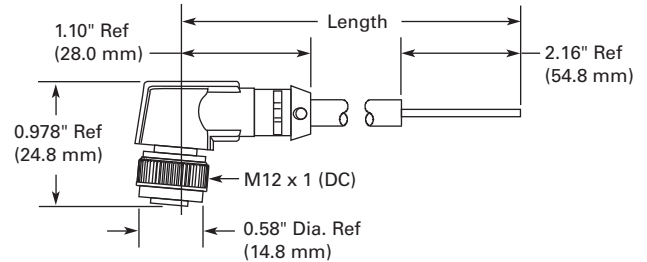

Mini-Style Single Connector Cables, 2-, 3-, 4- and 5-pin, Versions

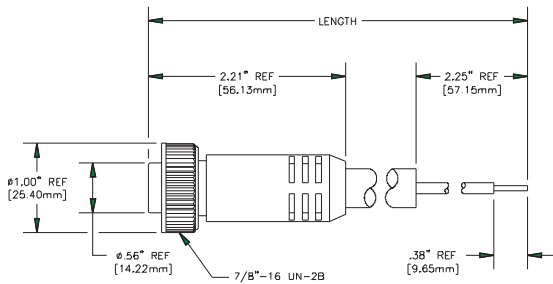

Mini-Style Single Connector Cables, 9-pin, Version

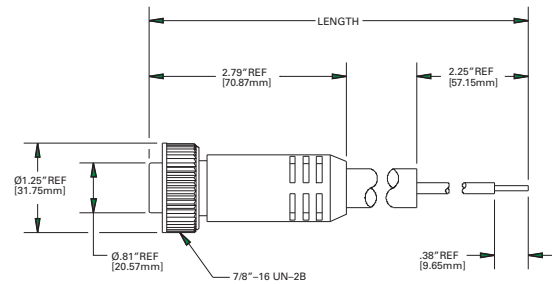

Nano-Style Single Connector Cables, Straight Female

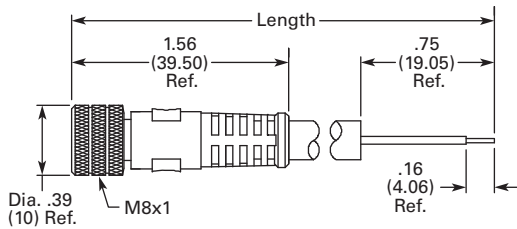

Nano-Style Single Connector Cables, Right Angle Female (Standard and LED)

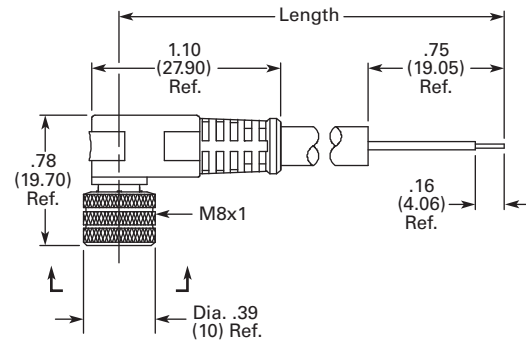

10.1 Sensor Connectivity

Global Plus Connector Cables

Approximate Dimensions in Inches (mm)

Double Connector Cable Dimensions

Micro-Style Double Connector Cables, Straight Female/Male

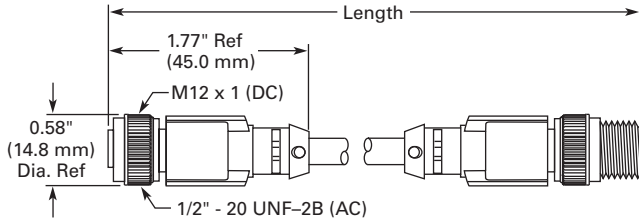

Micro-Style Double Connector Cables, Straight Female/Right Angle Male

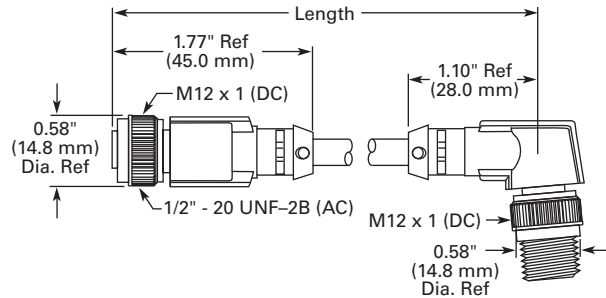

10

Receptacle Dimensions

Micro-Style Receptacles, Straight Male (1/2 in NPT Mounting)

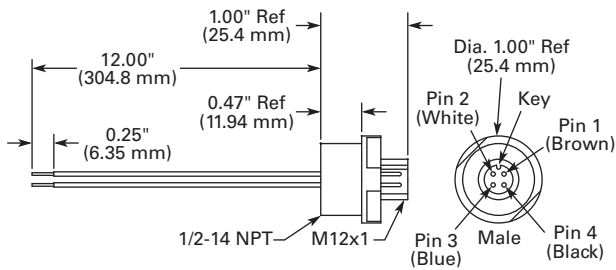

Micro-Style Receptacles, Straight Male (PG9 Mounting)

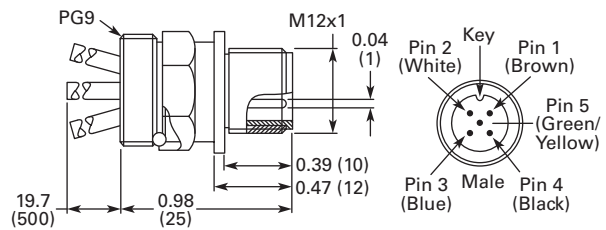

Mini-Style Receptacles, Straight Male

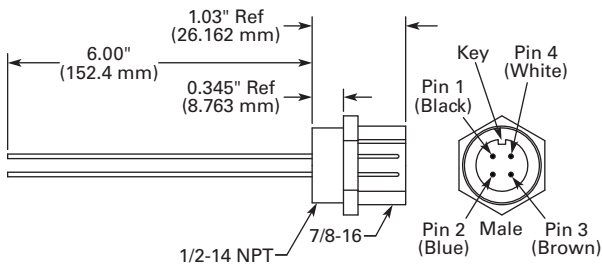

Multi-Connector Blocks



Multi-Connector Blocks

Product Description

The Multi-Connector Block from Eaton's Electrical Sector is an easy way to quickly connect sensors to a control system. Using a variety of double-ended, industry-standard M12 micro-connector cables, a system can be wired up in minutes, therefore saving installation time and money.

For further convenience and installation troubleshooting, LEDs provide both power and output status on the block.

Global Plus Multi-Connector Blocks were designed with the most heavy-duty applications in mind—such as automotive manufacturing, metalworking and machinery OEMs. Put Eaton's Global Plus Multi-Connector Blocks to the test for your next machine design.

Application Description

Typical Applications

- Automotive manufacturing
- Metalworking
- Many types of Machinery OEMs
- Power Control and Panel Shops

Contents

Description	Page
Multi-Connector Blocks	
Product Selection	V8-T10-14
Accessories	V8-T10-14
Technical Data and Specifications	V8-T10-14
Wiring Diagrams	V8-T10-15
Dimensions	V8-T10-15

Features

- Model options with four, six or eight sensor ports in one block
- Block capacity can be doubled with Micro Splitter Accessory (CSDY5)
- Capacity of up to 4A per port and 12A per block
- Robust design to resist vibration and moisture penetration
- Ideal for extreme temperature environments from -13° to 167°F (-25° to 75°C)

Standards and Certifications

- UL Recognized
- CSA Certified



⚠ DANGER

THIS SENSOR IS NOT A SAFETY DEVICE AND IS NOT INTENDED TO BE USED AS A SAFETY DEVICE. This sensor is designed only to detect and read certain data in an electronic manner and perform no use apart from that, specifically no safety-related use. This sensor product does not include self-checking redundant circuitry, and the failure of this sensor product could cause either an energized or de-energized output condition, which could result in death, serious bodily injury, or property damage.

For the most current information on this product, visit our Web site: www.eaton.com

For Customer Service in the U.S. call 1-877-ETN CARE (386-2273), in Canada call 1-800-268-3578.
For Application Assistance in the U.S. and Canada call 1-800-426-9184.

10.2

Sensor Connectivity

Multi-Connector Blocks

Product Selection

Multi-Connector Block

Micro-Style Molded Cable



Micro-Style Molded Cable

Voltage Style	Number of Ports	Connection	Pin Configuration/Wire Colors	Catalog Number
DC PNP	4-port	5m cable	See Wiring Diagrams on Page V8-T10-15	CBDR4P05
		10m cable		CBDR4P10
	6-port	5m cable		CBDR6P05
		10m cable		CBDR6P10
	8-port	5m cable		CBDR8P05
		10m cable		CBDR8P10

Accessories

Closure Cap



Closure Cap

Description	Catalog Number
Seals off unused connector ports on multi-connector blocks, micro female type	CBCAP

Technical Data and Specifications

Multi-Connector Blocks

Description	Specification
General	
Nominal voltage (Vdc)	24
Maximum operating voltage (Vdc)	30
Current capacity per port (A)	4
Residual current (A)	12
Operating current of each LED (mA)	≤5
Protection type (IEC 60 529 / EN 60 529 / DIN VDE 0470-1)	IP65
Ambient temperature	−13° to 167°F (−25° to 75°C)
Jacket material	Nylon with brass receptacles
Contact material	Gold-plated copper alloy
O-ring	Nitrile rubber
Voltage rating	10–30 Vdc
Current rating	4A per port; 12A max. per unit
Contact resistance	5M ohms max.
Isolation resistance	1000M ohms min.
Protection	NEMA 6P, IP67
Temperature range	−13° to 194°F (−25° to 90°C)
LED Status Indication	
Supply voltage	Green
Status display of I/O	Yellow

Master Cable—Pre-Wired Cable Connection

Description	Specification
Signal line, stranded in mm ² (AWG)	0.34 (22)
Voltage supply, stranded in mm ² (AWG)	3 x 1.0 (17)
Cable diameter in mm [in]	
4- and 6-port	8.7 [0.3425]
8-port	9.2 [0.3622]
Material	PUR
Cable strain relief	30 lbs. min.

Wiring Diagrams

Micro-Style Connector Blocks

PNP Block

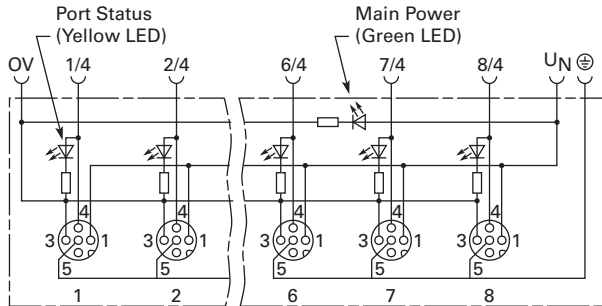

Wiring Diagram for Molded Cable Blocks

Micro DC Port/pin,	4-Port Wire Color	6-Port Wire Color	8-Port Wire Color
1/4	WH	WH	WH
2/4	GN	GN	GN
3/4	YE	YE	YE
4/4	GY	GY	GY
5/4	—	PK	PK
6/4	—	RD	RD
7/4	—	—	BK
8/4	—	—	VT
1-8/1; U _N (+V)	BN	BN	BN
1-8/3; OV (-)	BU	BU	BU
1-8/5; PE (GND)	GN/YE	GN/YE	GN/YE

Dimensions

Approximate Dimensions in Inches (mm)

Micro-Style Connector Blocks

Four Sensor Ports

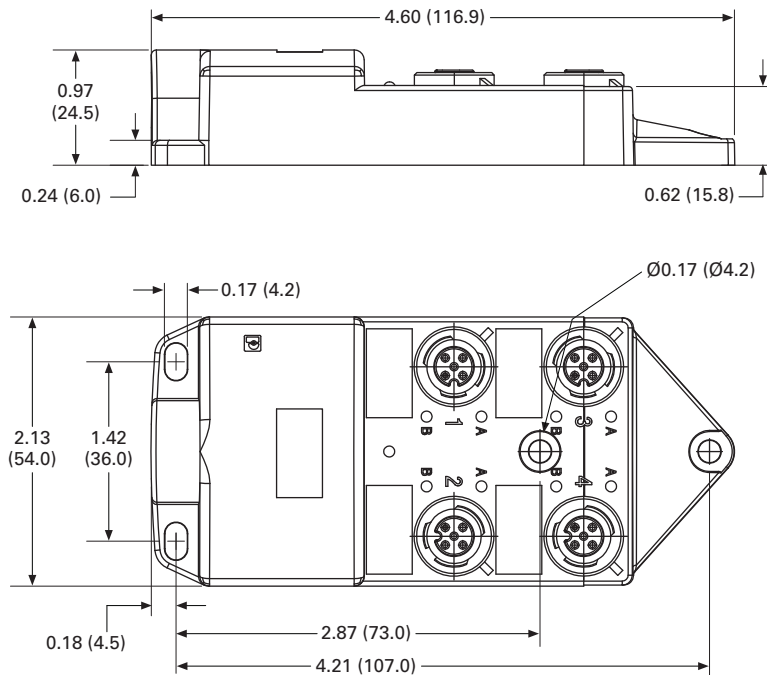

10.2 Sensor Connectivity

Multi-Connector Blocks

Approximate Dimensions in Inches (mm)

Six Sensor Ports

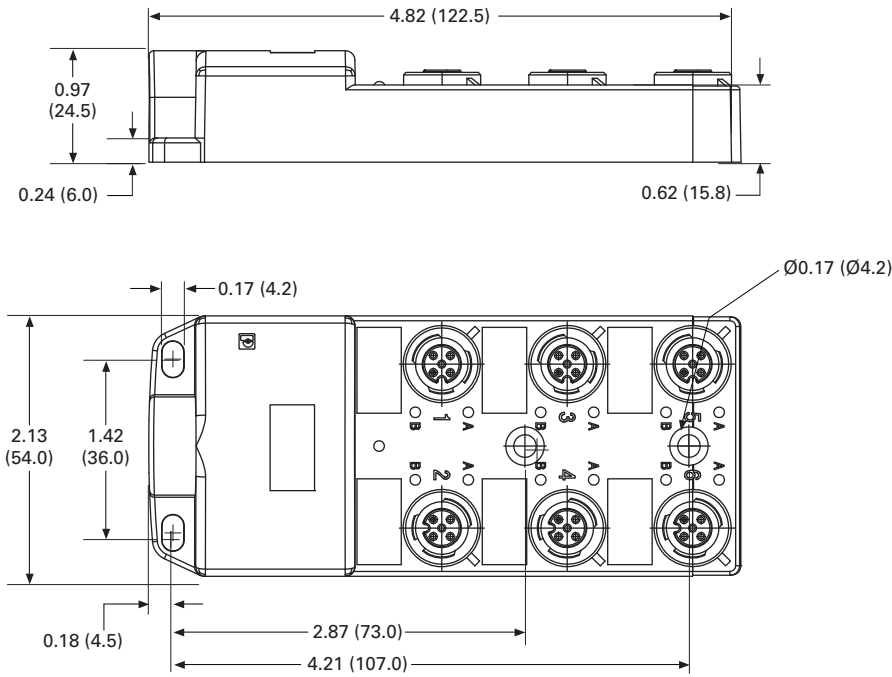

Eight Sensor Ports

