

Clock OSC

SG5032CAN

SEIKO EPSON CORPORATION

Product name SG5032CAN 37.40000 MHz TJGA
 Product Number / Ordering code X1G0044510089xx

Please refer to the 8.Packing information about xx (last 2 digits)

Output waveform CMOS

Pb free / Complies with EU RoHS directive

Reference weight Typ. 52 mg

1.Absolute maximum ratings

Parameter	Symbol	Min.	Typ.	Max.	Unit	Conditions / Remarks
Maximum supply voltage	V _{cc} -GND	-0.3	-	4	V	-
Storage temperature	T _{stg}	-40	-	+125	°C	Storage as single product
Input voltage	V _{in}	-0.3	-	V _{cc} +0.3	V	ST terminal

2.Specifications(characteristics)

Parameter	Symbol	Min.	Typ.	Max.	Unit	Conditions / Remarks
Output frequency	f ₀		37.4000		MHz	
Supply voltage	V _{cc}	1.6	-	3.6	V	-
Operating temperature	T _{use}	-40	-	+85	°C	-
Frequency tolerance	f _{tol}	-50	-	50	x10 ⁻⁶	T _{use}
Current consumption	I _{cc}	-	-	3	mA	No load condition
Stand-by current	I _{std}	-	-	2.7	μA	ST = GND
Disable current	I _{dis}	-	-	-	mA	-
Symmetry	SYM	45	-	55	%	50% V _{cc} Level L _{CMOS} =<15pF
Output voltage	V _{OH}	V _{cc} -0.4	-	-		-
	V _{OL}	-	-	0.4		-
Output load condition	L _{CMOS}	-	-	15	pF	CMOS Load
Input voltage	V _{IH}	0.8V _{cc}	-	-		ST terminal
	V _{IL}	-	-	0.2V _{cc}		ST terminal
Rise time	t _r	-	-	4	ns	V _{cc} 1.6V : 0.2V _{cc} to 0.8V _{cc} Level, L _{CMOS} =15pF
Fall time	t _f	-	-	4	ns	V _{cc} 1.6V : 0.2V _{cc} to 0.8V _{cc} Level, L _{CMOS} =15pF
Start-up time	t _{str}	-	-	3	ms	t = 0 at 0.9V _{cc}
Jitter	t _{DJ}	-	0	-	ps	Deterministic Jitter V _{cc} =3.3V
	t _{RJ}	-	2.4	-	ps	Random Jitter V _{cc} =3.3V
	t _{RMS}	-	2.3	-	ps	δ(RMS of total distribution) V _{cc} =3.3V
	t _{p-p}	-	20	-	ps	Peak to Peak V _{cc} =3.3V
	t _{acc}	-	2.5	-	ps	Accumulated Jitter(δ) n=2 to 50000 cycles, V _{cc} =3.3V
Phase jitter	t _{PJ}	-	0.28	-	ps	Off set Frequency: 12kHz to 20MHz, V _{cc} =3.3V
Phase noise	L(f)	-	-	-	dBc/Hz	-
		-	-93	-	dBc/Hz	Off set 10Hz V _{cc} =3.3V
		-	-122	-	dBc/Hz	Off set 100Hz V _{cc} =3.3V
		-	-144	-	dBc/Hz	Off set 1kHz V _{cc} =3.3V
		-	-154	-	dBc/Hz	Off set 10kHz V _{cc} =3.3V
		-	-158	-	dBc/Hz	Off set 100kHz V _{cc} =3.3V
		-	-159	-	dBc/Hz	Off set 1MHz V _{cc} =3.3V
Frequency aging	f _{age}	-3	-	3	x10 ⁻⁶	@+25°C first year
		-	-	-		-

3. Timing chart

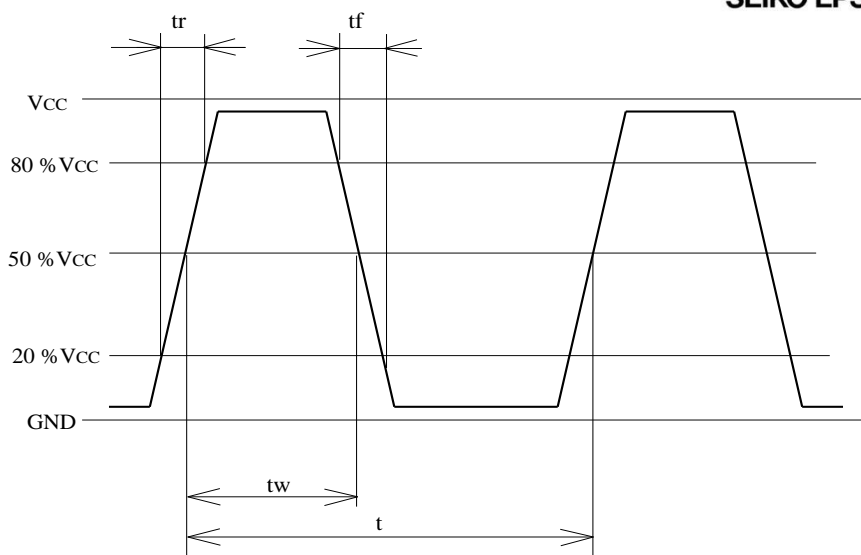

4. Test circuit

1) Waveform observation

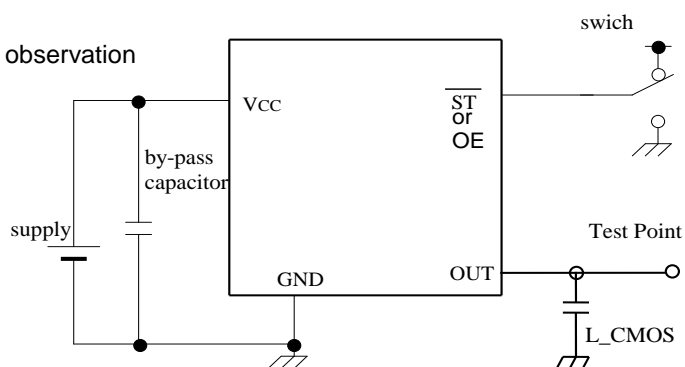

2) Current consumption

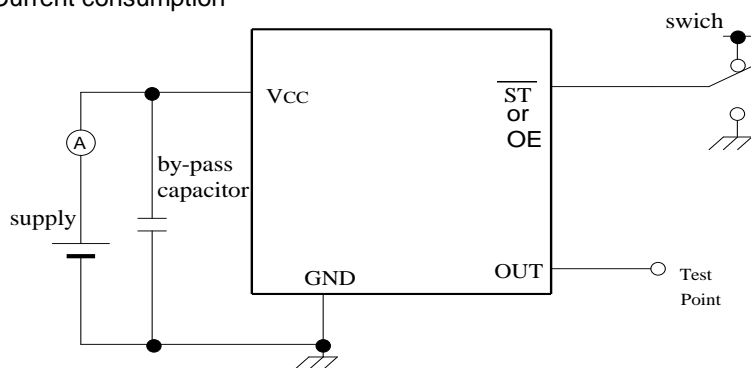

*Current consumption under the disable function should be = GND.

3) Condition

(1) Oscilloscope

- Band width should be minimum 5 times higher (wider) than measurement frequency.
- Probe earth should be placed closely from test point and lead length should be as short as possible

* Recommendable to use miniature socket. (Don't use earth lead.)

(2) L_CMOS also includes probe capacitance.

(3) By-pass capacitor (0.01 μ F to 0.1 μ F) is placed closely between VCC and GND.

(4) Use the current meter whose internal impedance value is small.

(5) Power supply

- Start up time (0 %VCC to 90 %VCC) of power source should be more than 150 μ s.
- Impedance of power supply should be as lowest as possible.

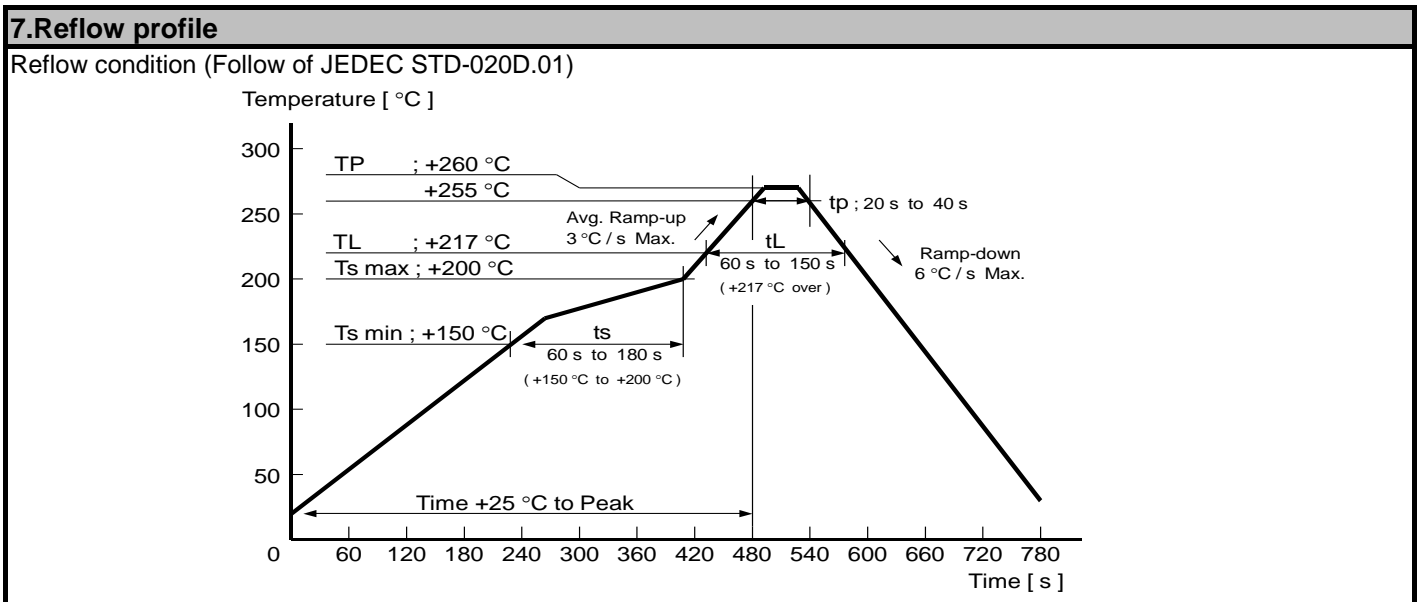
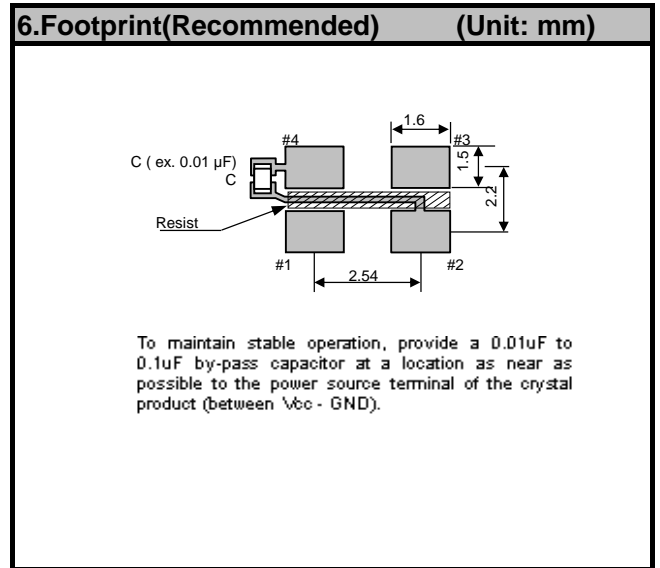
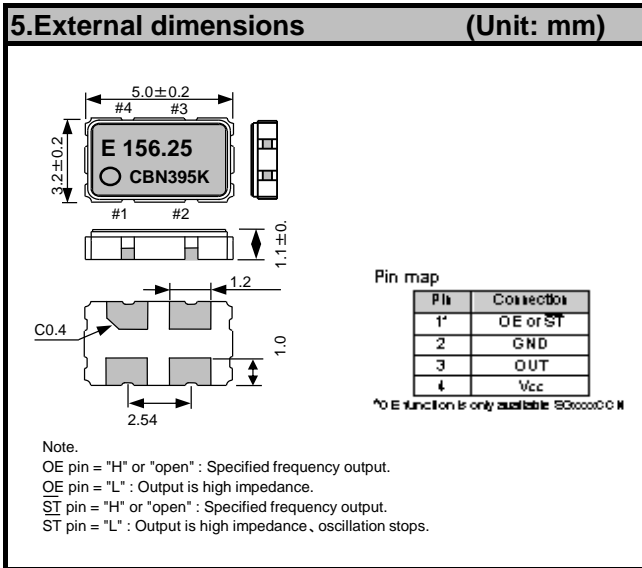

8.Packing information

[1] Product number last 2 digits code(xx) description The recommended code is "00"

X1G0044510089xx

Code	Condition	Code	Condition
01	Any Q'ty vinyl bag(Tape cut)	13	500pcs / Reel
11	Any Q'ty / Reel	00	1000pcs / Reel
12	250pcs / Reel		

[2] Taping specification

Subject to EIA-481 & IEC-60286

(1) Tape dimensions

Material of the Carrier Tape : PS

Material of the Top Tape : PET+PE

Unit: mm

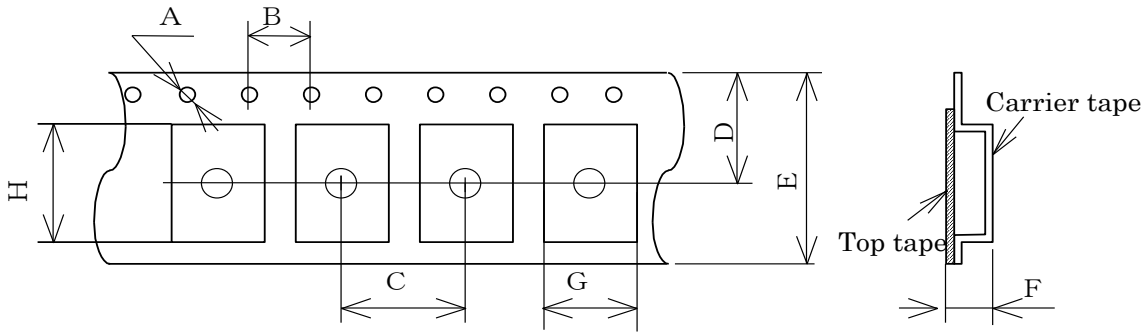

Symbol	A	B	C	D	E	F	G	H
Value	$\phi 1.5$ $+0.1/-0$	4.0 ± 0.1	8.0 ± 0.1	7.25 ± 0.2	12.0 ± 0.2	1.40 ± 0.1	3.5 ± 0.1	5.4 ± 0.1

(2) Reel dimensions

Center material : PS

Material of the Reel : PS

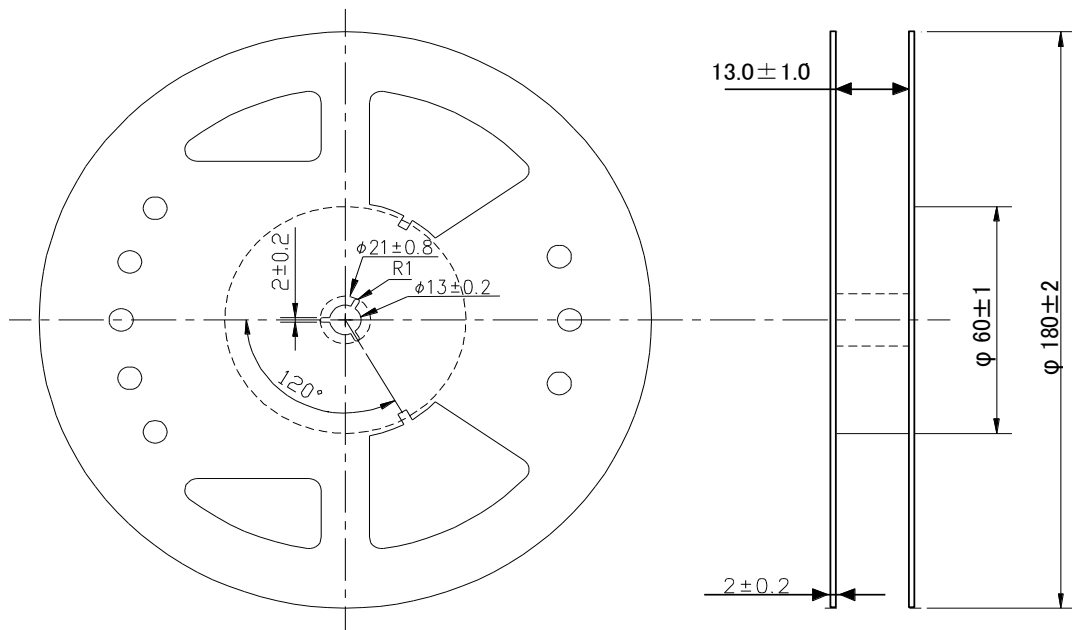

9. Notice

- This material is subject to change without notice.
- Any part of this material may not be reproduced or duplicated in any form or any means without the written permission of Seiko Epson.
- The information about applied data, circuitry, software, usage, etc. written in this material is intended for reference only.
Seiko Epson does not assume any liability for the occurrence of customer damage or infringing on any patent or copyright of a third party.
This material does not authorize the licensing for any patent or intellectual copyrights.
- When exporting the products or technology described in this material, you should comply with the applicable export control laws and regulations and follow the procedures required by such laws and regulations.
- You are requested not to use the products (and any technical information furnished, if any) for the development and/or manufacture of weapon of mass destruction or for other military purposes. You are also requested that you would not make the products available to any third party who may use the products for such prohibited purposes.
- These products are intended for general use in electronic equipment. When using them in specific applications that require extremely high reliability, such as the applications stated below, you must obtain permission from Seiko Epson in advance.
 - / Space equipment (artificial satellites, rockets, etc.)
 - / Transportation vehicles and related (automobiles, aircraft, trains, vessels, etc.)
 - / Medical instruments to sustain life
 - / Submarine transmitters
 - / Power stations and related
 - / Fire work equipment and security equipment
 - / Traffic control equipment
 - / And others requiring equivalent reliability.

10. Contact us

<http://www5.epsondevice.com/en/contact/>