

TCXO

TG-5006CJ

SEIKO EPSON CORPORATION

Product name TG-5006CJ-22L 16.367667 MHz

Product Number / Ordering code X1G0041310013xx

Please refer to the 10.Packing information about xx (last 2 digits)

Output waveform Clipped sine wave

Pb free / Complies with EU RoHS directive

Reference weight Typ.9.1mg

1.Absolute maximum ratings

Parameter	Symbol	Min.	Typ.	Max.	Unit	Conditions / Remarks
Maximum supply voltage	V _{CC-GND}	-0.3	-	4	V	V _{CC} terminal
Storage temperature	T _{stg}	-40	-	90	°C	Storage as single product

2.Operating Conditions

Parameter	Symbol	Min.	Typ.	Max.	Unit	Conditions / Remarks
Supply voltage	V _{CC}	1.7	-	3.3	V	GND = 0V
Operating temperature	T _{use}	-30	25	85	°C	-
Output load condition	Load _R Load _C	9 9	10 10	11 11	kΩ pF	- DC cut capacitor=0.01μF

DC-cut capacitor is not included in this TCXO. Please attach an external DC-cut capacitor (0.01 μF Min.) to the out pin.

(V_{CC}=1.8, 2.8, 3.0, 3.3 V, V_C=1.65 V, GND=0.0 V, Load 10 kΩ//10 pF(DC cut), T_{use}=+25°C)**3.Frequency Characteristics**

Parameter	Symbol	Min.	Typ.	Max.	Unit	Conditions / Remarks
Output frequency	f ₀	-	16.3677	-	MHz	
Frequency tolerance	f _{tol}	-2.0	-	2.0	x10 ⁻⁶	T _{use} = +25°C, Reflow 2 times
Frequency / temperature characteristics	f ₀ -T _c	-2	-	2	x10 ⁻⁶	T _{use} = -30 °C to +85 °C
Frequency / load coefficient	f ₀ -Load	-0.2	-	0.2	x10 ⁻⁶	10 kΩ // 10 pF +/- 10%
Frequency / voltage coefficient	f ₀ -V _{CC}	-0.2	-	0.2	x10 ⁻⁶	V _{CC} +/- 5 %
Frequency slope	-	-	-	-	x10 ⁻⁶ /°C	-
Frequency aging	f _{age}	-1.0	-	1.0	x10 ⁻⁶	1st year, T _{use} =25degC

*1 Include initial frequency tolerance and frequency deviation after reflow cycles.

*2 Measured in the elapse of 24 hours after reflow soldering.

*3 V_{CC} +/- 5% must be in operating supply voltage range (1.7 V to 3.47 V)(V_{CC}=1.8, 2.8, 3.0, 3.3 V, V_C=1.65 V, GND=0.0 V, Load 10 kΩ//10 pF(DC cut), T_{use}=+25°C)**4.Electrical Characteristics**

Parameter	Symbol	Min.	Typ.	Max.	Unit	Conditions / Remarks
Current consumption	I _{CC}	-	-	1.5	mA	T _{Use} = +25°C, 10 kΩ//10pF
Symmetry	SYM	40	-	60	%	GND Level
Output voltage	V _{p-p}	0.8	-	1.5	V	Peak to peak 10 kΩ//10pF +/- 10%
Harmonics	-	-	-	-8	dBc	-
start up time	t _{osc}	-	-	2.0	ms	Within 90% of final amp.
Phase noise	L(f)	-	-	-85	dBc/Hz	Offset:10 Hz
		-	-	-110	dBc/Hz	Offset:100 Hz
		-	-	-132	dBc/Hz	Offset:1 kHz
		-	-	-148	dBc/Hz	Offset:10 kHz
		-	-	-148	dBc/Hz	Offset:100 kHz
		-	-	-148	dBc/Hz	Offset:1 MHz

5. Timing chart

Output waveform (Clipped sine wave output)

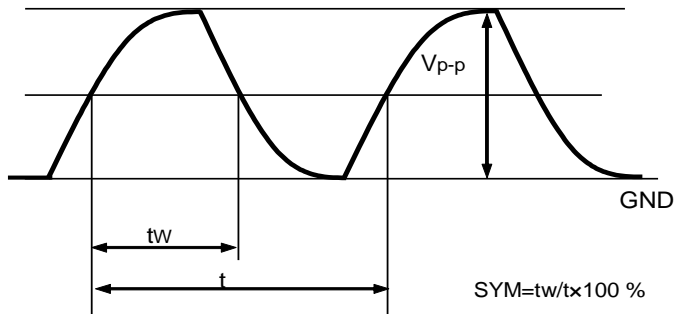

6. Test circuit for TCXO

1) Output Load : 10 k Ω //10 pF

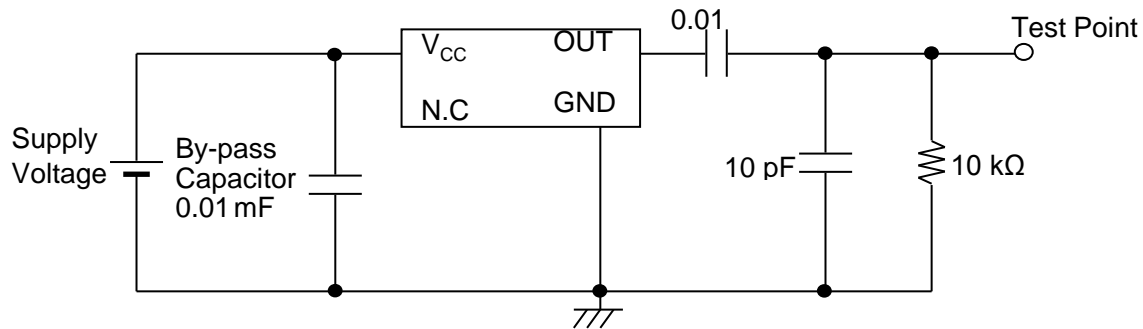

2) Current consumption

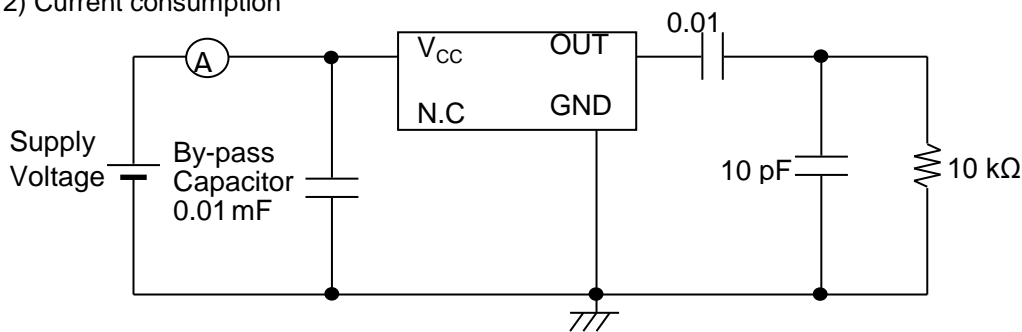

3) Conditions

1. Oscilloscope:

Impedance	Min. 1 M Ω
Input capacitance	Max. 10 pF
Band width	Min. 300 MHz

Impossible to measure both frequency and wave form at the same time. (In case of using oscilloscope's amplifier output, possible to measure both at the same time.)

2. Load_C includes probe capacitance.
3. A capacitor (By-pass: 0.01 to 0.1 μ F) is placed between V_{CC} and GND, and closely to TCXO.
4. Use the current meter whose internal impedance value is small.
5. Power Supply
Impedance of power supply should be as low as possible.

7.External dimensions (Unit: mm)

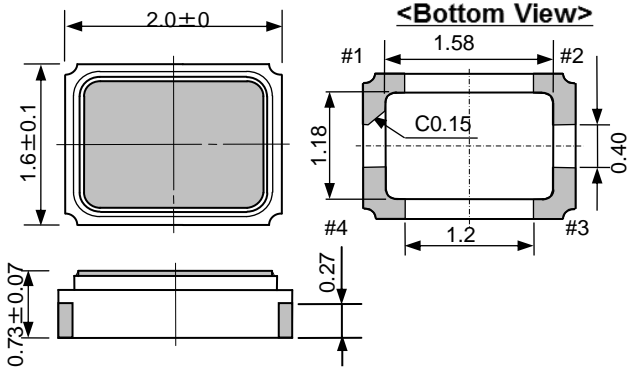

Pin map

Pin	Connection	
	VC-TCXO	TCXO
1	Vc	N.C.
2	GND	
3	OUT	
4	Vcc	

8.Footprint(Recommended) (Unit: mm)

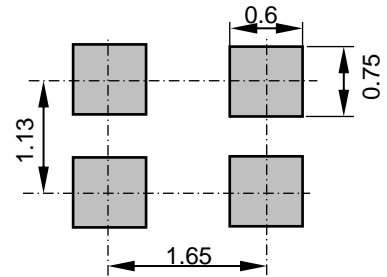

To maintain stable operation, provide a 0.01uF to 0.1uF by-pass capacitor at a location as near as possible to the power source terminal of the crystal product (between Vcc - GND).

9.Reflow profile

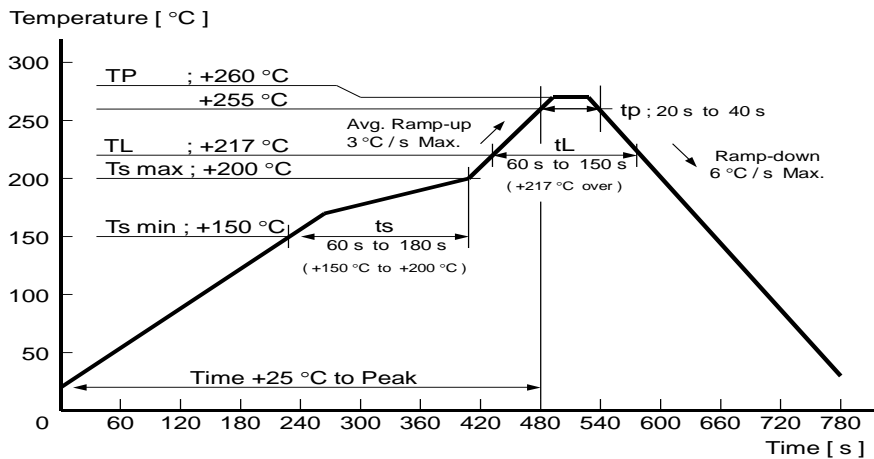

10.Packing information

[1] Product number last 2 digits code(xx) description The recommended code is "00"
X1G0041310013xx

Code	Condition	Code	Condition
00	12000pcs / Reel	14	1000pcs / Reel
01	Any Q'ty vinyl bag(Tape cut)	15	2000pcs / Reel
11	Any Q'ty / Reel	16	3000pcs / Reel

[2] Taping specification

Subject to EIA-481 & IEC-60286

(1) Tape dimensions TE0804L

Material of the Carrier Tape : PS

Material of the Top Tape : PET+PE

Unit: mm

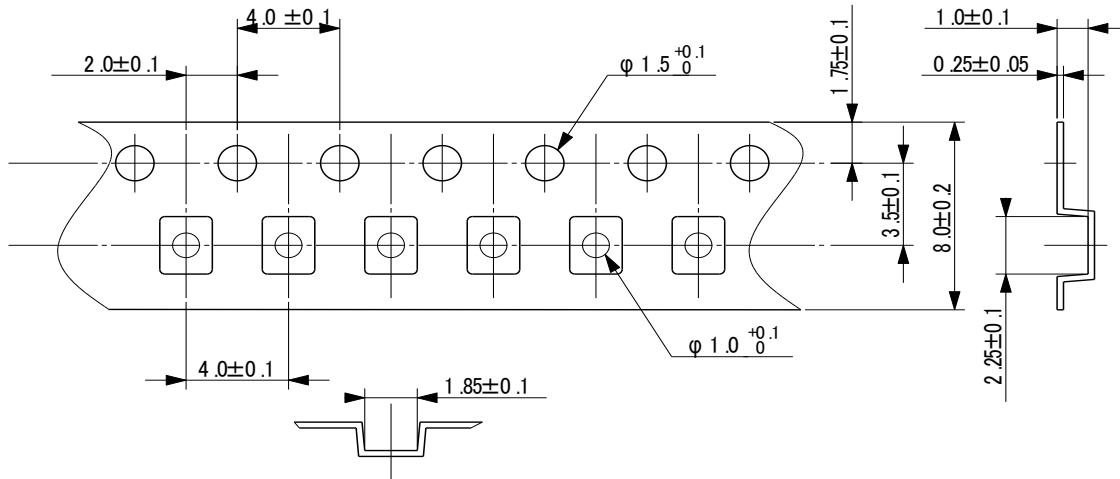

(2) Reel dimensions

Center material : PS

Material of the Reel : PS

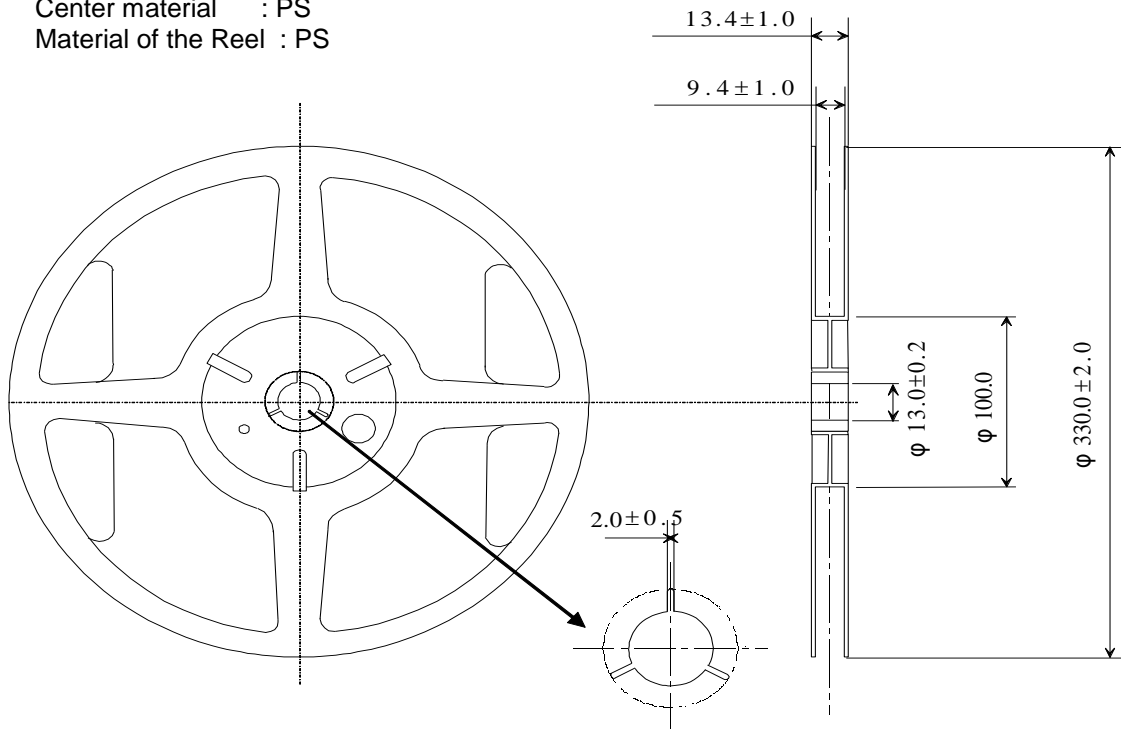

11. Handling precautions

Prior to using this product, please carefully read the section entitled "Precautions" on our Web site (<http://www5.epsondevice.com/en/quartz/tech/precaution/>) for instructions on how to handle and use the product properly to ensure optimal performance of the product in your equipment. Before using the product under any conditions other than those specified therein, please consult with us to verify and confirm that the performance of the product will not be negatively affected by use under such conditions.

In addition to the foregoing precautions, in order to avoid the deteriorating performance of the product, we strongly recommend that you DO NOT use the product under ANY of the following conditions:

- (1) Mounting the product on a board using water-soluble solder flux and using the product without removing the residue of the flux completely from the board. The residue of such flux that is soluble in water or water-soluble cleaning agent, especially the residues which contains active halogens, will negatively affect the performance and reliability of the product.
- (2) Using the product in any manner that will result in any shock or impact to the product.
- (3) Using the product in places where the product is exposed to water, chemicals, organic solvent, sunlight, dust, corrosive gasses, or other materials.
- (4) Using the product in places where the product is exposed to static electricity or electromagnetic waves.
- (5) Applying ultrasonic cleaning without advance verification and confirmation that the product will not be affected by such a cleaning process, because it may damage the crystal, IC and/or metal line of the product.
- (6) Touching the IC surface with tweezers or other hard materials directly.
- (7) Using the product under any other conditions that may negatively affect the performance and/or reliability of the product.
- (8) Using the product with power line ripple exceeding 50 mV(p-p) level.

Should any customer use the product in any manner contrary to the precautions and/or advice herein, such use

Notice

- This material is subject to change without notice.
- Any part of this material may not be reproduced or duplicated in any form or any means without the written permission of Seiko Epson.
- The information about applied data, circuitry, software, usage, etc. written in this material is intended for reference only.
Seiko Epson does not assume any liability for the occurrence of customer damage or infringing on any patent or copyright of a third party.
This material does not authorize the licensing for any patent or intellectual copyrights.
- When exporting the products or technology described in this material, you should comply with the applicable export control laws and regulations and follow the procedures required by such laws and regulations.
- You are requested not to use the products (and any technical information furnished, if any) for the development and/or manufacture of weapon of mass destruction or for other military purposes. You are also requested that you would not make the products available to any third party who may use the products for such prohibited purposes.
- These products are intended for general use in electronic equipment. When using them in specific applications that require extremely high reliability, such as the applications stated below, you must obtain permission from Seiko Epson in advance.
 - / Space equipment (artificial satellites, rockets, etc.)
 - / Transportation vehicles and related (automobiles, aircraft, trains, vessels, etc.)
 - / Medical instruments to sustain life
 - / Submarine transmitters
 - / Power stations and related
 - / Fire work equipment and security equipment
 - / Traffic control equipment
 - / And others requiring equivalent reliability.

Contact us

<http://www5.epsondevice.com/en/contact/>